

YE22
EUROPE

2022 / 2023



CUTTING TOOLS



HOLEMAKING



THREADING



MILLING



TOOLING SYSTEM

FREZEN

MILLING TOOLS

CBN END MILLS

i-Xmill END MILLS

i-SMART END MILLS

X5070 NANO SOLID CARBIDE END MILLS

4G Mill SOLID CARBIDE END MILLS

X-POWER PRO SOLID CARBIDE END MILLS

TitaNox-POWER SOLID CARBIDE END MILLS

JET-POWER SOLID CARBIDE & HSS-PM END MILLS

V7 PLUS SOLID CARBIDE END MILLS

ALU-POWER HPC SOLID CARBIDE END MILLS

ALU-POWER SOLID CARBIDE & HSS-PM END MILLS

D-POWER GRAPHITE SOLID CARBIDE END MILLS (DIAMOND COATED)

CRX S SOLID CARBIDE END MILLS

K-2 SOLID CARBIDE END MILLS

ONLY ONE COATED PM60 END MILLS

TANK-POWER HSS-PM END MILLS

GENERAL HSS (8% Cobalt) END MILLS

HSS-E MILLING CUTTERS

TECHNICAL DATA

CBN END MILLS

CBN END MILLS

CBN(Cubic Boron Nitride) Machining High Hardened Steels up to HRC70 / Mirror Finish

CBN
END MILLS

CARBIDE EXCHANGEABLE END MILLS

i-Xmills, CARBIDE INSERT END MILLS

Various Applications Type of Inserts Available for General Steels, Pre-Hardened Steels, High Hardened Steels, Stainless Steels and Graphite

i-Xmill
END MILLS

i-Smart MODULAR TYPE END MILLS

For General Steels, Hardened Steels and Cast Iron

i-SMART
MODULAR
END MILLS

SOLID CARBIDE END MILLS

X5070 NANO SOLID CARBIDE END MILLS

For High Hardened Steels (HRC45 to HRC70) / High Speed Machining and Dry Cutting

X5070
END MILLS

4G Mill SOLID CARBIDE END MILLS

High Speed Cutting for Pre-Hardened Steels up to HRC55

4G MILL
END MILLS

X-POWER PRO SOLID CARBIDE END MILLS

For Pre-Hardened Steels up to HRC55

X-POWER
PRO
END MILLS

TitaNox-POWER SOLID CARBIDE END MILLS

High Speed Machining for Exotic Materials: Titanium and Stainless Steels

TitaNox-
POWER
END MILLS

JET-POWER SOLID CARBIDE & HSS-PM END MILLS

For Exotic materials like Stainless Steels, Nickel Alloys and Titanium

JET-POWER
END MILLS

V7 PLUS SOLID CARBIDE END MILLS

High Performance Carbide End Mills for Steels, Cast Iron and Stainless Steels

V7 PLUS
END MILLS

ALU-POWER HPC SOLID CARBIDE END MILLS

For Aluminium, Aluminum Die Cast, Non-ferrous Alloys and Plastics

ALU-POWER
HPC
END MILLS

ALU-POWER SOLID CARBIDE END MILLS

For Aluminium Alloys and Silent Cutting

ALU-
POWER
END MILLS

D-POWER GRAPHITE SOLID CARBIDE END MILLS (DIAMOND COATED)

For Graphites

D-POWER
GRAPHITE
END MILLS

CRX S SOLID CARBIDE END MILLS

DLC Coated End Mills for Copper

CRX S
END MILLS

K-2 SOLID CARBIDE END MILLS

General Purpose / Conventional or High Speed Milling / Wet & Dry Cutting

K-2
END MILLS

HSS END MILLS

ONLY ONE COATED PM60 END MILLS

Perfect Solution of Carbide Chipping under Vibrations

ONLY ONE
COATED PM60
END MILLS

TANK-POWER HSS-PM END MILLS

High Toughness for Stainless Steels, Carbon steels and Alloy Steels / for General Application, Roughing & Finishing

TANK-
POWER
END MILLS

GENERAL HSS END MILLS

General Purpose / Coating Available

GENERAL
HSS
END MILLS

TECHNICAL DATA

HSS MILLING CUTTERS

General Works. Available Dovetail, Woodruff Keyseat, T-slot, Side Milling Cutters and HSS (8% Cobalt) Corner Rounding, Shell End Mills

MILLING
CUTTERS

TECHNICAL DATA

TECHNICAL
DATA

SELECTION GUIDE



MILLING TOOLS

SERIES	CBN		i-Xmill Insert			
	ESB94	ESD02	XMB110A	XMB120C	XMB260T	XMB130A
FLUTE	2	2	2	2	2	2
HELIX ANGLE	30°	0°	-	-	-	-
CUTTING EDGE SHAPE	BALL NOSE	CORNER RADIUS	BALL NOSE	BALL NOSE	BALL NOSE	BALL NOSE
SIZE MIN	R0.2	D0.5	R4.0	R4.0	R4.0	R4.0
SIZE MAX	R1.5	D2.0	R16.5	R16.5	R16.5	R16.5
PAGE	C35	C36	C42	C42	C42	C43
LENGTH	-	-	-	-	-	-
SURFACE TREATMENT	Uncoated	Uncoated	AlTiN	X-Coating	Z-Coating	AlTiN



Please visit globalyg1.com/mat for material search

◎ : Excellent
○ : Good

ISO	VDI 3323	Material Description	HB	HRc				
P	1	Non-alloy steel	125		◎			
	2		190	13	◎			
	3		250	25	◎			
	4		270	28	◎			
	5		300	32	◎			
	6	Low alloy steel	180	10	◎			
	7		275	29	◎			
	8		300	32	◎			
	9		350	38				
	10		High alloyed steel, and tool steel	200	15	○		
	11	325	35	◎				
M	12	Stainless steel	200	15			◎	
	13		240	23			◎	
	14		180	10			◎	
K	15	Grey cast iron	180	10		◎		
	16	260	26	◎				
	17	Nodular cast iron	160	3	◎			
	18		250	25	◎			
	19	Malleable cast iron	130		◎			
20	230		21	◎				
N	21	Aluminum-wrought alloy	60					
	22		100					
	23	Aluminum-cast, alloyed	75					
	24		90					
	25		130					
	26		110					
	27	Copper and Copper Alloys (Bronze / Brass)	90					
	28		100					
	29		Non Metallic Materials Duroplastic, Fiber Reinforced Plastic, Graphite, CFRP, GFRP, etc.					
	30							
S	31	Heat Resistant Super Alloys	200	15				
	32		280	30				
	33		250	25				
	34		350	38				
	35		320	34				
	36	Titanium Alloys	400 Rm					
	37		1050 Rm					
H	38	Hardened steel	550	55	◎	◎		
	39		630	60	◎	◎		
	40	Chilled Cast Iron	400	42			○	
	41	Hardened Cast Iron	550	55	◎	◎		

i-Xmill Insert							i-Xmill Holder					
XMM110V	XMB110D	XMR110A	XMR120C	XMR260T	XMF110V	XMR110D	ZBC	ZBS	ZBT	ZRC	ZRS	ZRT
2	2	2	2	2	2	2	-	-	-	-	-	-
-	-	-	-	-	-	-	-	-	-	-	-	-
BALL NOSE	BALL NOSE	CORNER RADIUS	CORNER RADIUS	CORNER RADIUS	CORNER RADIUS	CORNER RADIUS	BALL NOSE	BALL NOSE	BALL NOSE	CORNER RADIUS	CORNER RADIUS	CORNER RADIUS
R4.0	R4.0	D8.0	D8.0	D8.0	D8.0	D8.0	-	-	-	-	-	-
R16.5	R16.5	D33.0	D33.0	D33.0	D33.0	D33.0	-	-	-	-	-	-
C43	C43	C44	C44	C44	C49	C49	C54	C55	C56	C57	C58	C58
FULL RADIUS	-	-	-	-	HIGH FEED	-	STRAIGHT NECK	STRAIGHT NECK	TAPER NECK	STRAIGHT NECK	STRAIGHT NECK	TAPER NECK
Y-Coating	Diamond	AlTiN	X-Coating	Z-Coating	Y-Coating	Diamond	Carbide	Steel	Steel	Carbide	Steel	Steel



◎		◎			◎								1
◎		◎			◎								2
◎		◎			◎								3
◎		◎			◎								4
◎		◎			◎								5
◎		◎			◎								6
◎		◎			◎								7
		◎											8
			◎										9
◎			○		◎								10
			◎										11
		◎											12
		◎											13
		◎											14
			◎										15
			◎										16
			◎										17
			◎										18
			◎										19
			◎										20
						○							21
						○							22
						○							23
						○							24
													25
													26
													27
													28
						◎				◎			29
													30
													31
													32
													33
													34
													35
													36
													37
													38
													39
													40
													41

SELECTION GUIDE



MILLING TOOLS

SERIES	i-Smart Modular Head					
	XSEMD98	XSEME59	XSEME60	XSEME01	XSEME68	XSEME36
FLUTE	2	3	4	4	6	4
HELIX ANGLE	30°	30°	30°	27°/30° (MULTIPLE HELIX)	45°	27°/30° (MULTIPLE HELIX)
CUTTING EDGE SHAPE	BALL NOSE	BALL NOSE	BALL NOSE	CORNER RADIUS	CORNER RADIUS	SQUARE
SIZE MIN	R5.0	R5.0	R5.0	D10.0	D10.0	D10.0
SIZE MAX	R16.0	R16.0	R16.0	D32.0	D32.0	D32.0
PAGE	C68	C69	C70	C71	C72	C74
LENGTH	CENTER MATCH	CENTER MATCH	CENTER MATCH	-	-	-
SURFACE TREATMENT	Y-Coating	Y-Coating	Y-Coating	Y-Coating	Y-Coating	Y-Coating



Please visit globalyg1.com/mat for material search

◎ : Excellent
○ : Good

ISO	VDI 3323	Material Description	HB	HRc	XSEMD98	XSEME59	XSEME60	XSEME01	XSEME68	XSEME36
P	1	Non-alloy steel	125	13	○	○	○	○	○	○
	2		190	13	○	○	○	○	○	○
	3		250	25	○	○	○	◎	○	◎
	4		270	28	◎	◎	◎	◎	◎	◎
	5	300	32	◎	◎	◎	◎	◎	◎	
	6	180	Low alloy steel	10	10	○	○	○	○	○
	7	275		29	◎	◎	◎	◎	◎	◎
	8	300		32	◎	◎	◎	◎	◎	◎
	9	350		38	◎	◎	◎	◎	◎	◎
	10	200		High alloyed steel, and tool steel	15	15	○	○	○	○
	11	325	35		◎	◎	◎	◎	◎	◎
M	12	Stainless steel	200	15						
	13		240	23						
K	14		180	10						○
	15	Grey cast iron	180	10	○	○	○	○	○	○
	16		260	26	○	○	○	○	○	○
	17	Nodular cast iron	160	3	○	○	○	○	○	○
	18		250	25	○	○	○	○	○	○
19	Malleable cast iron	130		○	○	○	○	○	○	
20		230	21	○	○	○	○	○	○	
N	21	Aluminum-wrought alloy	60							
	22		100							
	23	Aluminum-cast, alloyed	75							
	24		90							
	25		130							
	26		110							
	27	Copper and Copper Alloys (Bronze / Brass)	90							
	28		100							
	29		Non Metallic Materials (Duroplastic, Fiber Reinforced Plastic, Graphite, CFRP, GFRP, etc.)							
	30									
S	31	Heat Resistant Super Alloys	200	15						
	32		280	30						
	33		250	25						
	34		350	38						
	35	320	34							
	36	Titanium Alloys	400 Rm							
	37		1050 Rm							
H	38	Hardened steel	550	55	○	○	○	○	○	○
	39		630	60	○	○	○	○	○	○
	40	Chilled Cast Iron	400	42	◎	◎	◎	◎	◎	◎
	41	Hardened Cast Iron	550	55	○	○	○	○	○	○

	i-Smart Modular Holder			X5070									
	XSEME75	ZMC	ZMS	ZMT	G8B59	G8B54	G8A46	G8A54	G8A28	G8A38	G8A53	G8A59	G8D62
6	-	-	-	4	4	2	2	2	2	2	2	3	4
45°	-	-	-	0°	0°	30°	30°	30°	30°	30°	30°	30°	30°
SQUARE	-	-	-	CORNER RADIUS	CORNER RADIUS	BALL NOSE	BALL NOSE	BALL NOSE	BALL NOSE	BALL NOSE	BALL NOSE	BALL NOSE	BALL NOSE
D10.0	-	-	-	D2.0	D2.0	R0.05	R0.25	R0.05	R0.5	R0.2	R1.5	R1.5	R1.5
D32.0	-	-	-	D12.0	D16.0	R2.0	R1.0	R6.0	R12.5	R1.0	R10.0	R10.0	R10.0
C75	C76	C77	C78	C89	C90	C91	C95	C96	C98	C99	C100	C101	C101
-	STRAIGHT NECK TYPE	STRAIGHT NECK TYPE	TAPER NECK TYPE	HIGH FEED	HIGH FEED LONG SHANK	RIB PROCESSING	RIB PROCESSING	-	EXTENDED NECK	MINIATURE	Center Match	Center Match	Center Match
Y-Coating	Carbide	Steel	Steel	Blue Coating	Blue Coating	Blue Coating	Blue Coating	Blue Coating	Blue Coating	Blue Coating	Blue Coating	Blue Coating	Blue Coating



○														1
○														2
◎														3
◎														4
◎				○	○	○	○	○	○	○	○	○	○	5
○														6
◎														7
◎				○	○	○	○	○	○	○	○	○	○	8
◎				○	○	○	○	○	○	○	○	○	○	9
◎				○	○	○	○	○	○	○	○	○	○	10
◎				○	○	○	○	○	○	○	○	○	○	11
														12
														13
														14
○														15
○														16
○														17
○														18
○														19
○														20
														21
														22
														23
														24
														25
														26
														27
														28
														29
														30
														31
														32
														33
														34
														35
														36
														37
○														38
○														39
◎														40
○														41

SELECTION GUIDE



MILLING TOOLS

SERIES	X5070							
	G8A60	G8A36	G8A52	G8A50	G8A47	G8A37	G8B08	G8A39
FLUTE	2	2	2	2	4	4	4	6
HELIX ANGLE	30°	30°	30°	30°	30°	30°	30°	45°
CUTTING EDGE SHAPE	CORNER RADIUS	CORNER RADIUS	CORNER RADIUS	CORNER RADIUS	CORNER RADIUS	CORNER RADIUS	CORNER RADIUS	CORNER RADIUS
SIZE MIN	D0.5	D0.3	D0.5	D0.3	D3.0	D1.0	D6.0	D6.0
SIZE MAX	D12.0	D20.0	D2.0	D2.0	D12.0	D20.0	D12.0	D20.0
PAGE	C102	C107	C109	C110	C111	C112	C113	C114
LENGTH	RIB PROCESSING	EXTENDED NECK	RIB PROCESSING	MINIATURE	EXTENDED NECK	EXTENDED NECK	EXTENDED NECK	EXTENDED NECK
SURFACE TREATMENT	Blue Coating	Blue Coating	Blue Coating	Blue Coating	Blue Coating	Blue Coating	Blue Coating	Blue Coating

 Please visit globalyg1.com/mat for material search
 ◎ : Excellent
 ○ : Good

ISO	VDI 3323	Material Description	HB	HRC	G8A60	G8A36	G8A52	G8A50	G8A47	G8A37	G8B08	G8A39
P	1	Non-alloy steel	125	13								
	2		190	13								
	3		250	25								
	4		270	28								
	5	300	32	○	○	○	○	○	○	○	○	○
	6	180	10									
	7	275	29									
	8	300	32	○	○	○	○	○	○	○	○	○
	9	350	38	○	○	○	○	○	○	○	○	○
	10	200	15									
	11	325	35	○	○	○	○	○	○	○	○	○
M	12	200	15									
	13	240	23									
K	14	180	10									
	15	180	10									
	16	260	26									
	17	160	3									
K	18	250	25									
	19	130										
	20	230	21									
N	21	Aluminum-wrought alloy	60									
	22	Aluminum-cast, alloyed	100									
	23		75									
	24		90									
	25		130									
	26	Copper and Copper Alloys (Bronze / Brass)	110									
	27		90									
	28		100									
	29	Non Metallic Materials (Duroplastic, Fiber Reinforced Plastic, Graphite, CFRP, GFRP, etc.)										
	30											
S	31	Heat Resistant Super Alloys	200	15								
	32		280	30								
	33		250	25								
	34		350	38								
	35	320	34									
	36	Titanium Alloys	400 Rm									
37		1050 Rm										
H	38	Hardened steel	550	55	◎	◎	◎	◎	◎	◎	◎	◎
	39		630	60	◎	◎	◎	◎	◎	◎	◎	◎
	40	Chilled Cast Iron	400	42	○	○	○	○	○	○	○	○
	41	Hardened Cast Iron	550	55	◎	◎	◎	◎	◎	◎	◎	◎

X5070					4G Mills						
G8A45	G8A01	G8A02	G8D63	G8D64	SEMD98	SEM846	SEM846	SEMD99	SEME61	SEME01	SEME64
2	2	4	6&8	6&8	2	2	2	2	2	4	4
30°	30°	30°	45°	45°	30°	30°	30°	30°	30°	27°/30° (MULTIPLE HELIX)	27°/30° (MULTIPLE HELIX)
SQUARE	SQUARE	SQUARE	SQUARE	SQUARE	BALL NOSE	BALL NOSE	BALL NOSE	CORNER RADIUS	CORNER RADIUS	CORNER RADIUS	CORNER RADIUS
D0.1	D0.1	D1.0	D6.0	D6.0	R0.05	R0.05	R0.25	D0.2	D0.2	D1.0	D1.0
D4.0	D20.0	D20.0	D25.0	D25.0	R12.5	R6.0	R1.0	D20.0	D20.0	D20.0	D20.0
C115	C119	C120	C121	C122	C150	C156	C166	C169	C177	C196	C203
RIB PROCESSING	EXTENDED NECK	EXTENDED NECK	LONG LENGTH	EXTRA LONG LENGTH	-	EXTENDED NECK	EXTENDED NECK (6mm Shank)	-	EXTENDED NECK	-	EXTENDED NECK
Blue Coating	Blue Coating	Blue Coating	Blue Coating	Blue Coating	Y-Coating	Y-Coating	Y-Coating	Y-Coating	Y-Coating	Y-Coating	Y-Coating



					○	○	○	○	○	○	○	1
					○	○	○	○	○	○	○	2
					◎	◎	◎	◎	◎	◎	◎	3
					◎	◎	◎	◎	◎	◎	◎	4
○	○	○	○	○	◎	◎	◎	◎	◎	◎	◎	5
					○	○	○	○	○	○	○	6
					◎	◎	◎	◎	◎	◎	◎	7
○	○	○	○	○	◎	◎	◎	◎	◎	◎	◎	8
○	○	○	○	○	◎	◎	◎	◎	◎	◎	◎	9
○	○	○	○	○	◎	◎	◎	◎	◎	◎	◎	10
					◎	◎	◎	◎	◎	◎	◎	11
												12
												13
												14
					○	○	○	○	○	○	○	15
					○	○	○	○	○	○	○	16
					○	○	○	○	○	○	○	17
					○	○	○	○	○	○	○	18
					○	○	○	○	○	○	○	19
					○	○	○	○	○	○	○	20
												21
												22
												23
												24
												25
												26
												27
												28
												29
												30
												31
												32
												33
												34
												35
												36
												37
◎	◎	◎	◎	◎	○	○	○	○	○	○	○	38
◎	◎	◎	◎	◎	○	○	○	○	○	○	○	39
○	○	○	○	○	◎	◎	◎	◎	◎	◎	◎	40
◎	◎	◎	◎	◎	○	○	○	○	○	○	○	41

SELECTION GUIDE



MILLING TOOLS

SERIES

FLUTE

HELIX ANGLE
CUTTING EDGE
SHAPE

SIZE MIN

SIZE MAX

PAGE

LENGTH

SURFACE TREATMENT

4G Mills

SERIES	SEME35	SEME35	SEME35	SEME70	SEM845	SEME36	SEME71	SEME72	SEME73	SEME75
FLUTE	2	2	2	2	2	4	4	4	4	6
HELIX ANGLE	30°	30°	30°	30°	30°	27°/30° (MULTIPLE HELIX)	35°/38° (MULTIPLE HELIX)	30°	30°	45°
CUTTING EDGE SHAPE	SQUARE	SQUARE	SQUARE	SQUARE	SQUARE	SQUARE	SQUARE	SQUARE	SQUARE	SQUARE
SIZE MIN	D0.1	D0.1	D0.1	D1.0	D0.1	D0.8	D1.0	D1.0	D1.0	D6.0
SIZE MAX	D25.0	D4.0	D3.0	D25.0	D12.0	D25.0	D20.0	D25.0	D12.0	D20.0
PAGE	C218	C221	C222	C223	C229	C238	C240	C244	C250	C255
LENGTH	-	4mm Shank	3mm Shank	LONG LENGTH	EXTENDED NECK	-	Sharp Corner Removal	LONG LENGTH	EXTENDED NECK	-
SURFACE TREATMENT	Y-Coating	Y-Coating	Y-Coating	Y-Coating	Y-Coating	Y-Coating	Y-Coating	Y-Coating	Y-Coating	Y-Coating

⊙ : Excellent
○ : Good

Please visit globalyg1.com/mat for material search

ISO	VDI 3323	Material Description	HB	HRc	SEME35	SEME35	SEME35	SEME70	SEM845	SEME36	SEME71	SEME72	SEME73	SEME75	
P	1	Non-alloy steel	125	13	○	○	○	○	○	○	○	○	○	○	
	2		190	13	○	○	○	○	○	○	○	○	○	○	
	3		250	25	⊙	⊙	⊙	⊙	⊙	⊙	⊙	⊙	⊙	⊙	
	4		270	28	⊙	⊙	⊙	⊙	⊙	⊙	⊙	⊙	⊙	⊙	
	5	300	32	⊙	⊙	⊙	⊙	⊙	⊙	⊙	⊙	⊙	⊙		
	6	180	Low alloy steel	10	○	○	○	○	○	○	○	○	○	○	
	7	275		29	⊙	⊙	⊙	⊙	⊙	⊙	⊙	⊙	⊙	⊙	
	8	300		32	⊙	⊙	⊙	⊙	⊙	⊙	⊙	⊙	⊙	⊙	
	9	350		38	⊙	⊙	⊙	⊙	⊙	⊙	⊙	⊙	⊙	⊙	
	10	200		High alloyed steel, and tool steel	15	○	○	○	○	○	○	○	○	○	○
	11	325	35		⊙	⊙	⊙	⊙	⊙	⊙	⊙	⊙	⊙	⊙	
M	12	Stainless steel	200	15											
	13		240	23											
K	14		180	10	○	○	○	○	○	○	○	○	○	○	
	15	Grey cast iron	180	10	○	○	○	○	○	○	○	○	○	○	
	16		260	26	○	○	○	○	○	○	○	○	○	○	
	17	Nodular cast iron	160	3	○	○	○	○	○	○	○	○	○	○	
	18		250	25	○	○	○	○	○	○	○	○	○	○	
19	Malleable cast iron	130		○	○	○	○	○	○	○	○	○	○		
20		230	21	○	○	○	○	○	○	○	○	○	○		
N	21	Aluminum-wrought alloy	60												
	22		100												
	23	Aluminum-cast, alloyed	75												
	24		90												
	25		130												
	26		110												
	27	Copper and Copper Alloys (Bronze / Brass)	90												
	28		100												
	29		Non Metallic Materials												
	30	Duroplastic, Fiber Reinforced Plastic, Graphite, CFRP, FRP, etc.													
S	31	Heat Resistant Super Alloys	200	15											
	32		280	30											
	33		250	25											
	34		350	38											
	35	320	34												
	36	Titanium Alloys	400 Rm												
	37		1050 Rm												
H	38	Hardened steel	550	55	○	○	○	○	○	○	○	○	○	○	
	39		630	60											
	40	Chilled Cast Iron	400	42	⊙	⊙	⊙	⊙	⊙	⊙	⊙	⊙	⊙	⊙	
	41	Hardened Cast Iron	550	55	○	○	○	○	○	○	○	○	○	○	

4G Mills X-Speed Rougher

X-Power Pro

G9D75 G9D67	G9D76 G9D68	G9D77 G9D69	GM876	GM813	GM886	GM902	GM815	GM818	GM8A1	GM839
4&5	4&5	4&5	2	2	2	2	4	2	2	4
44°~45° (MULTIPLE HELIX) CORNER RADIUS ROUGHING	44°~45° (MULTIPLE HELIX) CORNER RADIUS ROUGHING	44°~45° (MULTIPLE HELIX) CORNER RADIUS ROUGHING	30°	30°	30°	30°	30°	30°	30°	30°
D6.0	D6.0	D6.0	R0.5	R0.5	R0.25	R0.5	R1.0	D4.0	D1.0	D2.0
D20.0	D20.0	D20.0	R8.0	R10.0	R3.0	R4.0	R8.0	D12.0	D6.0	D12.0
C257	C258	C259	C332	C333	C334	C336	C337	C338	C339	C341
SHORT LENGTH	LONG LENGTH	LONG LENGTH	SHORT LENGTH	LONG LENGTH	RIB PROCESSING	TAPER NECK	LONG LENGTH	LONG LENGTH	RIB PROCESSING	STUB LENGTH
X-Coating	X-Coating	X-Coating	Y-Coating	Y-Coating	Y-Coating	Y-Coating	Y-Coating	Y-Coating	Y-Coating	Y-Coating

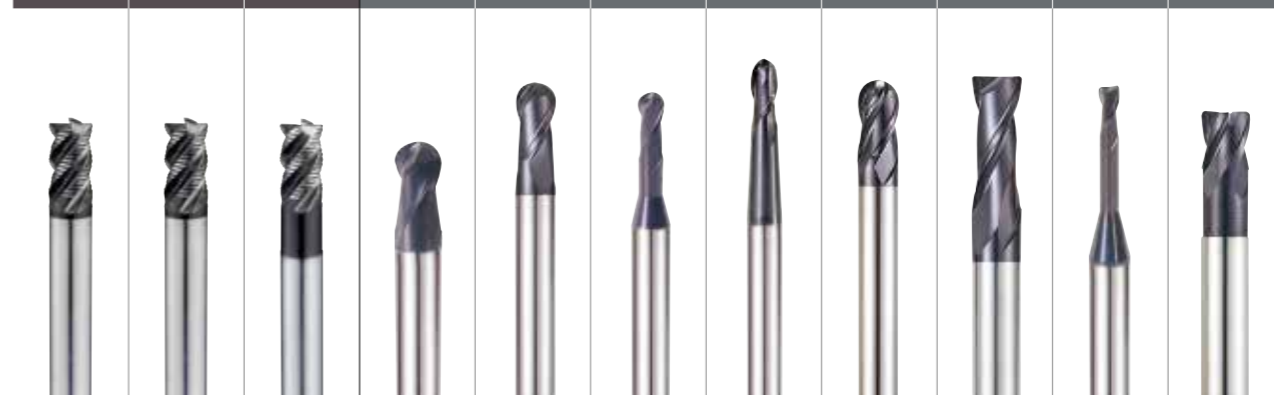

○	○	○	○	○	○	○	○	○	○	○	1
○	○	○	○	○	○	○	○	○	○	○	2
⊙	⊙	⊙	○	○	○	○	○	○	○	○	3
⊙	⊙	⊙	⊙	⊙	⊙	○	⊙	⊙	⊙	⊙	4
⊙	⊙	⊙	⊙	⊙	⊙	○	⊙	⊙	⊙	⊙	5
○	○	○	○	○	○	○	○	○	○	○	6
⊙	⊙	⊙	⊙	⊙	⊙	○	⊙	⊙	⊙	⊙	7
⊙	⊙	⊙	⊙	⊙	⊙	○	⊙	⊙	⊙	⊙	8
⊙	⊙	⊙	⊙	⊙	⊙	○	⊙	⊙	⊙	⊙	9
○	○	○	○	○	○	○	○	○	○	○	10
⊙	⊙	⊙	⊙	⊙	⊙	○	⊙	⊙	⊙	⊙	11
○	○	○									12
○	○	○									13
○	○	○									14
⊙	⊙	⊙	○	○	○		○	○	○	○	15
⊙	⊙	⊙	○	○	○		○	○	○	○	16
⊙	⊙	⊙	○	○	○		○	○	○	○	17
⊙	⊙	⊙	○	○	○		○	○	○	○	18
⊙	⊙	⊙	○	○	○		○	○	○	○	19
⊙	⊙	⊙	○	○	○		○	○	○	○	20
											21
											22
											23
											24
											25
○	○	○									26
○	○	○									27
○	○	○									28
											29
											30
											31
											32
											33
											34
											35
											36
											37
											38
											39
⊙	⊙	⊙	⊙	⊙	⊙	○	⊙	⊙	⊙	⊙	40
○	○	○	○	○	○	○	○	○	○	○	41

SELECTION GUIDE



MILLING TOOLS

SERIES	X-Power Pro					
	GM819	GM810	GM883	GM895	GM811	GM817
FLUTE	4	2	2	3	4	4
HELIX ANGLE	30°	30°	30°	38°	30°	30°
CUTTING EDGE SHAPE	CORNER RADIUS	SQUARE	SQUARE	SQUARE	SQUARE	SQUARE
SIZE MIN	D3.0	D0.4	D0.4	D1.0	D2.0	D2.0
SIZE MAX	D20.0	D20.0	D6.0	D16.0	D25.0	D20.0
PAGE	C342	C343	C345	C348	C349	C350
LENGTH	LONG LENGTH	SHORT LENGTH	RIB PROCESSING	SHORT LENGTH	SHORT LENGTH	LONG LENGTH
SURFACE TREATMENT	Y-Coating	Y-Coating	Y-Coating	Y-Coating	Y-Coating	Y-Coating

Please visit globalyg1.com/mat for material search
 ◎ : Excellent
 ○ : Good

ISO	VDI 3323	Material Description	HB	HRc	GM819	GM810	GM883	GM895	GM811	GM817
P	1	Non-alloy steel	125		○	○	○	○	○	○
	2		190	13	○	○	○	○	○	○
	3		250	25	○	○	○	○	○	○
	4		270	28	◎	◎	◎	◎	◎	◎
	5	300	32	◎	◎	◎	◎	◎	◎	
	6	180	Low alloy steel	10	○	○	○	○	○	○
	7	275		29	◎	◎	◎	◎	◎	◎
	8	300		32	◎	◎	◎	◎	◎	◎
	9	350		38	◎	◎	◎	◎	◎	◎
	10	200		High alloyed steel, and tool steel	15	○	○	○	○	○
	11	325	35		◎	◎	◎	◎	◎	◎
M	12	Stainless steel	200	15	○	○	○	○	○	○
	13		240	23	○	○	○	○	○	○
	14		180	10	○	○	○	○	○	○
K	15	Grey cast iron	180	10	○	○	○	○	○	○
	16		260	26	○	○	○	○	○	○
	17	Nodular cast iron	160	3	○	○	○	○	○	○
	18		250	25	○	○	○	○	○	○
	19		130		○	○	○	○	○	○
20	Malleable cast iron	230	21	○	○	○	○	○	○	
N	21	Aluminum-wrought alloy	60							
	22		100							
	23	Aluminum-cast, alloyed	75							
	24		90							
	25		130							
	26		110							
	27	Copper and Copper Alloys (Bronze / Brass)	90							
	28		100							
	29		Non Metallic Materials Duroplastic, Fiber Reinforced Plastic, Graphite, CFRP, GFRP, etc.							
	30									
S	31	Heat Resistant Super Alloys	200	15						
	32		280	30						
	33		250	25						
	34		350	38						
	35	320	34							
	36	Titanium Alloys	400 Rm							
	37		1050 Rm							
H	38	Hardened steel	550	55	○	○	○	○	○	○
	39		630	60						
	40	Chilled Cast Iron	400	42	◎	◎	◎	◎	◎	◎
	41	Hardened Cast Iron	550	55	○	○	○	○	○	○

X-Power Pro			TitaNox-Power					
GM812	GM834	GM814	GMG40 GMG41	GMG28 GMG29	GMG30 GMG31	GMG24 GMG25	GMG26 GMG27	EHE54 EHE55
6&8	6	3&4	4	5	5	5	5	5
45°	45°	20°	43°/45° (MULTIPLE HELIX)	43°/44°/45° (MULTIPLE HELIX)	43°/44°/45° (MULTIPLE HELIX)	43°/44°/45° (MULTIPLE HELIX)	43°/44°/45° (MULTIPLE HELIX)	40°
SQUARE	SQUARE	ROUGHING	CORNER RADIUS	CORNER RADIUS	CORNER RADIUS	SQUARE	SQUARE	ROUGHING CORNER RADIUS
D6.0	D6.0	D6.0	D6.0	D6.0	D6.0	D6.0	D6.0	D6.0
D20.0	D25.0	D20.0	D25.0	D25.0	D25.0	D25.0	D25.0	D25.0
C351	C352	C353	C380	C382	C383	C385	C386	C387
LONG LENGTH	EXTRA LONG LENGTH	LONG LENGTH	LONG LENGTH DOUBLE CORE	SHORT LENGTH	LONG LENGTH	SHORT LENGTH	LONG LENGTH	-
Y-Coating	Y-Coating	Y-Coating	Y-Coating	Y-Coating	Y-Coating	Y-Coating	Y-Coating	TiAlN

○	○	○	○	○	○	○	○	○	1
○	○	○	○	○	○	○	○	○	2
○	○	○	○	○	○	○	○	○	3
◎	◎	◎	◎	◎	◎	◎	◎	◎	4
◎	◎	◎	◎	◎	◎	◎	◎	◎	5
○	○	○	○	○	○	○	○	○	6
◎	◎	◎	◎	◎	◎	◎	◎	◎	7
◎	◎	◎	◎	◎	◎	◎	◎	◎	8
◎	◎	◎	◎	◎	◎	◎	◎	◎	9
◎	◎	◎	◎	◎	◎	◎	◎	◎	10
◎	◎	◎	◎	◎	◎	◎	◎	◎	11
			◎	◎	◎	◎	◎	○	12
			◎	◎	◎	◎	◎	○	13
			◎	◎	◎	◎	◎	○	14
○	○	○	○	○	○	○	○	○	15
○	○	○	○	○	○	○	○	○	16
○	○	○	○	○	○	○	○	○	17
○	○	○	○	○	○	○	○	○	18
○	○	○	○	○	○	○	○	○	19
○	○	○	○	○	○	○	○	○	20
									21
									22
									23
									24
									25
									26
									27
									28
									29
									30
			○	○	○	○	○	○	31
			○	○	○	○	○	○	32
			○	○	○	○	○	○	33
			○	○	○	○	○	○	34
			○	○	○	○	○	○	35
			◎	◎	◎	◎	◎	◎	36
			◎	◎	◎	◎	◎	◎	37
○	○	○							38
◎	◎	◎							39
○	○	○							40
									41

SELECTION GUIDE



MILLING TOOLS

SERIES	Jet-Power						
	EH911 EH912	EH913 EH914	EH915 EH916	EH831 EH841	EH917 EH918	EH919 EH920	EH921 EH942
FLUTE	2	4	6&8	Multi Flute	Multi Flute	Multi Flute	Multi Flute
HELIX ANGLE	35°	35°	45°	30°	45°	45°	45°
CUTTING EDGE SHAPE	SQUARE	SQUARE	SQUARE	ROUGHING	ROUGHING	ROUGHING	ROUGHING
SIZE MIN	D1.0	D2.0	D6.0	D6.0	D6.0	D4.0	D6.0
SIZE MAX	D25.0	D25.0	D25.0	D25.0	D20.0	D25.0	D20.0
PAGE	C396	C398	C400	C401	C402	C403	C404
LENGTH	SHORT LENGTH	SHORT LENGTH	LONG LENGTH	LONG LENGTH	SHORT LENGTH	LONG LENGTH	LONG LENGTH
SURFACE TREATMENT	TiAIN	TiAIN	TiAIN	TiAIN	TiAIN	TiAIN	TiAIN

Please visit globalyg1.com/mat for material search

⊙ : Excellent
○ : Good

ISO	VDI 3323	Material Description	HB	HRc	EH911 EH912	EH913 EH914	EH915 EH916	EH831 EH841	EH917 EH918	EH919 EH920	EH921 EH942	
P	1	Non-alloy steel	125	13	○	○	○	○	○	○	○	
	2		190	13	○	○	○	○	○	○	○	
	3		250	25	⊙	⊙	⊙	⊙	⊙	⊙	⊙	
	4		270	28	⊙	⊙	⊙	⊙	⊙	⊙	⊙	
	5	300	32	⊙	⊙	⊙	⊙	⊙	⊙	⊙		
	6	180	Low alloy steel	10	○	○	○	○	○	○	○	
	7	275		29	⊙	⊙	⊙	⊙	⊙	⊙	⊙	
	8	300		32	⊙	⊙	⊙	⊙	⊙	⊙	⊙	
	9	350		38	⊙	⊙	⊙	⊙	⊙	⊙	⊙	
	10	200		High alloyed steel, and tool steel	15	○	○	○	○	○	○	○
	11	325	35		⊙	⊙	⊙	⊙	⊙	⊙	⊙	
M	12	Stainless steel	200	15	○	○	○	○	○	○	○	
	13		240	23	○	○	○	○	○	○	○	
K	14	Grey cast iron	180	10	○	○	○	○	○	○	○	
	15		260	26								
	16		Nodular cast iron	160	3							
	17			250	25							
	18		Malleable cast iron	130								
	19			230	21							
	N		20	Aluminum-wrought alloy	60							
21		100										
22		Aluminum-cast, alloyed	75									
23			90									
24			130									
25		Copper and Copper Alloys (Bronze / Brass)	110									
26			90									
27			100									
28		Non Metallic Materials Duroplastic, Fiber Reinforced Plastic, Graphite, CFRP, GFRP, etc.										
29												
30												
S	31	Heat Resistant Super Alloys	200	15			○	○	○	○	○	
	32		280	30			○	○	○	○	○	
	33		250	25			○	○	○	○	○	
	34		350	38			○	○	○	○	○	
	35	320	34			○	○	○	○	○		
	36	Titanium Alloys	400 Rm		⊙	⊙	⊙	⊙	⊙	⊙	⊙	
	37		1050 Rm		⊙	⊙	⊙	⊙	⊙	⊙	⊙	
H	38	Hardened steel	550	55								
	39		630	60								
	40	Chilled Cast Iron	400	42	○	○	○	○	○	○	○	
	41	Hardened Cast Iron	550	55								

V7 Plus

GMG55 GMG56	GMF54 GMF55	GMF58 GMF59	GMF62 GMF63	GMF52 GMF53	GMF56 GMF57	GMF60 GMF61	GMG16 GMG17	GMG18 GMG19	GMH58 GMH59	GMG12 GMG13
4	4	4	4	4	4	4	6	6	6	6
35°/37° (MULTIPLE HELIX)	35°/37° (MULTIPLE HELIX)	35°/37° (MULTIPLE HELIX)	35°/37° (MULTIPLE HELIX)	35°/37° (MULTIPLE HELIX)	35°/37° (MULTIPLE HELIX)	35°/37° (MULTIPLE HELIX)	45°	45°	45°	45°
BALL NOSE	CORNER RADIUS	CORNER RADIUS	CORNER RADIUS	SQUARE	SQUARE	SQUARE	CORNER RADIUS	CORNER RADIUS	CORNER RADIUS	SQUARE
R1.5	D3.0	D3.0	D3.0	D3.0	D3.0	D3.0	D6.0	D6.0	D6.0	D6.0
R12.5	D20.0	D25.0	D20.0	D20.0	D25.0	D20.0	D25.0	D25.0	D25.0	D25.0
C418	C419	C420	C421	C424	C425	C426	C428	C429	C431	C432
LONG LENGTH	SHORT LENGTH	LONG LENGTH	LONG LENGTH with NECK	SHORT LENGTH	LONG LENGTH	LONG LENGTH with NECK	LONG LENGTH	EXTRA LONG LENGTH	EXTRA LONG LENGTH	LONG LENGTH
Y-Coating	Y-Coating	Y-Coating	Y-Coating	Y-Coating	Y-Coating	Y-Coating	Y-Coating	Y-Coating	Y-Coating	Y-Coating



ISO	VDI 3323	Material Description	HB	HRc	GMG55 GMG56	GMF54 GMF55	GMF58 GMF59	GMF62 GMF63	GMF52 GMF53	GMF56 GMF57	GMF60 GMF61	GMG16 GMG17	GMG18 GMG19	GMH58 GMH59	GMG12 GMG13		
P	1	Non-alloy steel	125	13	○	○	○	○	○	○	○	○	○	○	○		
	2		190	13	○	○	○	○	○	○	○	○	○	○	○		
	3		250	25	⊙	⊙	⊙	⊙	⊙	⊙	⊙	⊙	⊙	⊙	⊙		
	4		270	28	⊙	⊙	⊙	⊙	⊙	⊙	⊙	⊙	⊙	⊙	⊙		
	5	300	32	⊙	⊙	⊙	⊙	⊙	⊙	⊙	⊙	⊙	⊙	⊙			
	6	180	Low alloy steel	10	○	○	○	○	○	○	○	○	○	○	○		
	7	275		29	⊙	⊙	⊙	⊙	⊙	⊙	⊙	⊙	⊙	⊙	⊙		
	8	300		32	⊙	⊙	⊙	⊙	⊙	⊙	⊙	⊙	⊙	⊙	⊙		
	9	350		38	⊙	⊙	⊙	⊙	⊙	⊙	⊙	⊙	⊙	⊙	⊙		
	10	200		High alloyed steel, and tool steel	15	○	○	○	○	○	○	○	○	○	○	○	
	11	325	35		⊙	⊙	⊙	⊙	⊙	⊙	⊙	⊙	⊙	⊙	⊙		
M	12	Stainless steel	200	15	○	○	○	○	○	○	○	○	○	○	○		
	13		240	23	○	○	○	○	○	○	○	○	○	○	○		
K	14	Grey cast iron	180	10	○	○	○	○	○	○	○	○	○	○	○		
	15		260	26													
	16		Nodular cast iron	160	3												
	17			250	25												
	18		Malleable cast iron	130													
	19			230	21												
	20																
N	21	Aluminum-wrought alloy	60														
	22		100														
	23		Aluminum-cast, alloyed	75													
	24			90													
	25			130													
	26		Copper and Copper Alloys (Bronze / Brass)	110													
	27			90													
	28			100													
	29		Non Metallic Materials Duroplastic, Fiber Reinforced Plastic, Graphite, CFRP, GFRP, etc.														
	30																
31																	
S	31	Heat Resistant Super Alloys	200	15			○	○	○	○	○	○	○	○	○		
	32		280	30			○	○	○	○	○	○	○	○	○		
	33		250	25			○	○	○	○	○	○	○	○	○	○	
	34		350	38			○	○	○	○	○	○	○	○	○	○	
	35	320	34			○	○	○	○	○	○	○	○	○	○		
	36	Titanium Alloys	400 Rm		⊙	⊙	⊙	⊙	⊙	⊙	⊙	⊙	⊙	⊙	⊙	⊙	
	37		1050 Rm		⊙	⊙	⊙	⊙	⊙	⊙	⊙	⊙	⊙	⊙	⊙	⊙	
H	38	Hardened steel	550	55													
	39		630	60													
	40	Chilled Cast Iron	400	42	○	○	○	○	○	○	○	○	○	○	○	○	
	41	Hardened Cast Iron	550	55													

SELECTION GUIDE



MILLING TOOLS

SERIES	V7 Plus			Alu-Power HPC			
	GMG14 GMG15	GMH56 GMH57	EMB72 EMB73	E5H24 JAH24	E5H25 JAH25	E5H22 JAH22	E5H23 JAH23
FLUTE	6	6	5	3	3	3	3
HELIX ANGLE	45°	45°	41°~45°	37°	37°	37°	37°
CUTTING EDGE SHAPE	SQUARE	SQUARE	SQUARE	CORNER RADIUS	CORNER RADIUS	SQUARE	SQUARE
SIZE MIN	D6.0	D6.0	D6.0	D6.0	D6.0	D3.0	D6.0
SIZE MAX	D25.0	D25.0	D25.0	D20.0	D20.0	D25.0	D20.0
PAGE	C433	C434	C435	C444	C447	C450	C451
LENGTH	EXTRA LONG LENGTH	EXTRA LONG LENGTH	LONG LENGTH	-	EXTENDED NECK	-	EXTENDED NECK
SURFACE TREATMENT	Y-Coating	Y-Coating	AlTiN	Uncoated	Uncoated	Uncoated	Uncoated
		CHIP SPLITTER	V7 INOX	DLC	DLC	DLC	DLC

Please visit globalyg1.com/mat for material search

◎ : Excellent
○ : Good

ISO	VDI 3323	Material Description	HB	HRc							
P	1	Non-alloy steel	125		◎	◎	◎				
	2		190	13	◎	◎	◎				
	3		250	25	◎	◎	○				
	4		270	28	◎	◎	○				
	5	300	32	◎	◎	○					
	6	180	10	◎	◎	◎					
	7	275	29	◎	◎	○					
	8	300	32	◎	◎	○					
	9	350	38	◎	◎	○					
	10	High alloyed steel, and tool steel	200	15	◎	◎	◎				
	11	325	35	◎	◎	○					
M	12	Stainless steel	200	15	◎	◎	◎				
	13		240	23	◎	◎	◎				
	14		180	10	◎	◎	◎				
	15		180	10	◎	◎	○				
K	16	Grey cast iron	260	26	◎	◎	○				
	17	Nodular cast iron	160	3	◎	◎	○				
	18		250	25	◎	◎	○				
	19	Malleable cast iron	130		◎	◎	○				
	20		230	21	◎	◎	○				
N	21	Aluminum-wrought alloy	60				◎	◎	◎	◎	
	22		100				◎	◎	◎	◎	
	23	Aluminum-cast, alloyed	75		◎	◎	◎	◎	◎	◎	
	24		90				◎	◎	◎	◎	
	25		130				○	○	○	○	
	26		110				○	○	○	○	
	27	Copper and Copper Alloys (Bronze / Brass)	90				○	○	○	○	
	28		100				○	○	○	○	
	29	Non Metallic Materials Duroplastic, Fiber Reinforced Plastic, Graphite, CFRP, GFRP, etc.					○	○	○	○	
	30										
S	31	Heat Resistant Super Alloys	200	15	○	○	○				
	32		280	30	○	○	○				
	33		250	25	○	○	○				
	34		350	38	○	○	○				
	35	320	34	○	○	○					
	36	Titanium Alloys	400 Rm		○	○	◎				
	37		1050 Rm		○	○	◎				
H	38	Hardened steel	550	55							
	39		630	60							
	40	Chilled Cast Iron	400	42							
	41	Hardened Cast Iron	550	55							

Alu-Power											
E5910	E5908	E5909	E5930	E5E51	E5E47	E5E48	E5522 E5521	E5E49	E5E50	E5742 E5711	E5E39 E5E40
2	3	2	2	3	1	2	2	3	3	3	3
50°	40°	30°	25°	45°	30°	45°	45°	45°	45°	30°	30°
BALL NOSE	BALL NOSE	CORNER RADIUS	CORNER RADIUS	CORNER RADIUS	SQUARE	SQUARE	SQUARE	SQUARE	SQUARE	ROUGHING	ROUGHING
R3.0	R1.0	D4.0	D2.0	D3.0	D2.0	D3.0	D3.0	D3.0	D3.0	D6.0	D6.0
R10.0	R8.0	D20.0	D20.0	D20.0	D12.0	D20.0	D20.0	D20.0	D20.0	D25.0	D20.0
C458	C459	C460	C461	C462	C463	C464	C465	C466	C467	C468	C469
NECK	NECK	NECK	NECK	LONG LENGTH	-	SHORT LENGTH	LONG LENGTH	LONG LENGTH	NECK	LONG LENGTH	NECK
Uncoated	Uncoated	Uncoated	Uncoated	Uncoated	Uncoated	Uncoated	Uncoated	Uncoated	Uncoated	Uncoated	Uncoated



												◎	◎	1
												◎	◎	2
												◎	◎	3
												◎	◎	4
														5
														6
														7
														8
														9
														10
														11
														12
														13
														14
														15
														16
														17
														18
														19
														20
														21
														22
														23
														24
														25
														26
														27
														28
														29
														30
														31
														32
														33
														34
														35
														36
														37
														38
														39
														40
														41

SELECTION GUIDE



MILLING TOOLS

SERIES

FLUTE

HELIX ANGLE

CUTTING EDGE SHAPE

SIZE MIN

SIZE MAX

PAGE

LENGTH

SURFACE TREATMENT

D-Power Graphite

Series	EI997	EIB93	EI880	EI451	EI450	EIB87	EI881
Flute	2	2	2	2	2	2	3
Helix Angle	30°	30°	30°	30°	30°	30°	30°
Cutting Edge Shape	BALL NOSE	BALL NOSE	BALL NOSE	BALL NOSE	BALL NOSE	BALL NOSE	BALL NOSE
Size Min	R0.1	R0.2	R1.0	R1.0	R1.0	R0.5	R1.0
Size Max	R3.0	R2.0	R6.0	R6.0	R6.0	R1.0	R6.0
Page	C478	C480	C481	C482	C483	C484	C485
Length	MINIATURE NECK	MINIATURE NECK	SHORT LENGTH NECK	LONG LENGTH NECK	LONG REACH NECK	TAPER NECK	SHORT LENGTH NECK
Surface Treatment	Diamond	Diamond	Diamond	Diamond	Diamond	Diamond	Diamond



Please visit globalyg1.com/mat for material search

◎ : Excellent
○ : Good

ISO	VDI 3323	Material Description	HB	HRC	
P	1	Non-alloy steel	125		
	2		190	13	
	3		250	25	
	4		270	28	
	5		300	32	
	6	Low alloy steel	180	10	
	7		275	29	
	8		300	32	
	9		350	38	
	10		High alloyed steel, and tool steel	200	15
	11	325	35		
M	12	Stainless steel	200	15	
	13		240	23	
	14		180	10	
	15		180	10	
K	16	Grey cast iron	260	26	
	17	Nodular cast iron	160	3	
	18		250	25	
	19	Malleable cast iron	130		
	20		230	21	
N	21	Aluminum-wrought alloy	60	○	
	22		100	○	
	23	Aluminum-cast, alloyed	75	○	
	24		90	○	
	25		130	○	
	26		110		
	27		90		
	28		100		
	29		Non Metallic Materials Duroplastic, Fiber Reinforced Plastic, Graphite, CFRP, GFRP, etc.	◎	
	30			◎	
S	31	Heat Resistant Super Alloys	200	15	
	32		280	30	
	33		250	25	
	34		350	38	
	35	320	34		
	36	Titanium Alloys	400 Rm		
	37		1050 Rm		
H	38	Hardened steel	550	55	
	39		630	60	
	40	Chilled Cast Iron	400	42	
	41	Hardened Cast Iron	550	55	

D-Power Graphite

Series	EI996	EIB86	EIA13	EIA14	EIB88	EIB04
Flute	2	2	3	3	4	2
Helix Angle	30°	30°	40°	40°	30°	30°
Corner Radius	CORNER RADIUS	CORNER RADIUS	CORNER RADIUS	CORNER RADIUS	CORNER RADIUS	-
Size Min	D0.2	D1.0	D2.0	D2.0	D6.0	D0.5
Size Max	D6.0	D2.0	D12.0	D12.0	D12.0	D12.0
Page	C486	C488	C489	C490	C491	C492
Length	MINIATURE NECK	TAPER NECK	SHORT LENGTH	LONG LENGTH	NECK	LONG LENGTH NECK
Surface Treatment	Diamond	Diamond	Diamond	Diamond	Diamond	Diamond

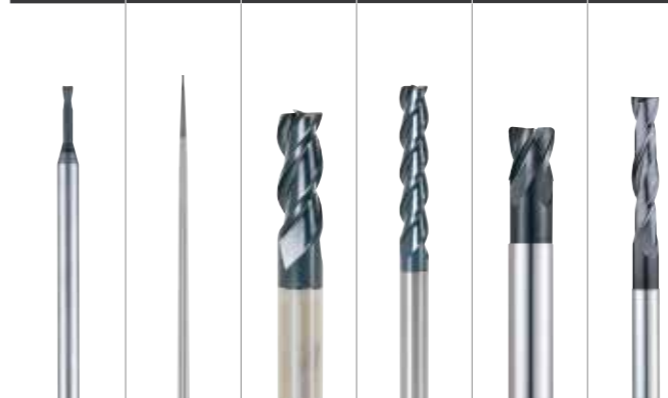

CRX S

Series	SGED28	SGED27	SGED29	SGED31	SGED30
Flute	2	2	2	2	2
Helix Angle	30°	30°	30°	30°	30°
Corner Radius	BALL NOSE	BALL NOSE	CORNER RADIUS	SQUARE	SQUARE
Size Min	R0.5	R0.25	D1.0	D1.0	D0.5
Size Max	R6.0	R6.0	D12.0	D12.0	D12.0
Page	C497	C498	C500	C502	C503
Length	-	EXTENDED NECK	EXTENDED NECK	-	EXTENDED NECK
Surface Treatment	DLC	DLC	DLC	DLC	DLC



SELECTION GUIDE



MILLING TOOLS

SERIES

FLUTE

HELIX ANGLE

CUTTING EDGE SHAPE

SIZE MIN

SIZE MAX

PAGE

LENGTH

SURFACE TREATMENT

K-2						
G9624	G9A70	G9437	G9438	G9454	G9455	G9B81
2	2	2	2	2	2	2
30°	30°	≈ 30°	≈ 30°	30°	30°	30°
BALL NOSE	BALL NOSE	BALL NOSE	BALL NOSE	BALL NOSE	BALL NOSE	BALL NOSE
R1.0	R0.5	R1.0	R1.0	R1.5	R1.5	R0.2
R10.0	R10.0	R10.0	R10.0	R10.0	R10.0	R2.0
C514	C515	C516	C517	C518	C519	C520
SHORT LENGTH	SHORT LENGTH	SHORT LENGTH	LONG LENGTH	LONG REACH	EXTRA LONG LENGTH	RIB PROCESSING
TiAIN	TiAIN	TiAIN	TiAIN	TiAIN	TiAIN	TiAIN

 Please visit globalyg1.com/mat for material search

◎ : Excellent
 ○ : Good

ISO	VDI 3323	Material Description	HB	HRc							
P	1	Non-alloy steel	125		◎	◎	◎	◎	◎	◎	◎
	2		190	13	◎	◎	◎	◎	◎	◎	◎
	3		250	25	◎	◎	◎	◎	◎	◎	◎
	4		270	28	◎	◎	◎	◎	◎	◎	◎
	5		300	32	◎	◎	◎	◎	◎	◎	◎
	6	180	Low alloy steel	10	◎	◎	◎	◎	◎	◎	◎
	7	275		29	◎	◎	◎	◎	◎	◎	◎
	8	300		32	◎	◎	◎	◎	◎	◎	◎
	9	350		38	◎	◎	◎	◎	◎	◎	◎
	10	200		High alloyed steel, and tool steel	15	◎	◎	◎	◎	◎	◎
	11	325	35		◎	◎	◎	◎	◎	◎	◎
M	12	Stainless steel	200	15	○	○	○	○	○	○	○
	13		240	23	○	○	○	○	○	○	○
	14		180	10	○	○	○	○	○	○	○
K	15	Grey cast iron	180	10	○	○	○	○	○	○	○
	16		260	26	○	○	○	○	○	○	○
	17	Nodular cast iron	160	3	○	○	○	○	○	○	○
	18		250	25	○	○	○	○	○	○	○
	19		130		○	○	○	○	○	○	○
20	Malleable cast iron	230	21	○	○	○	○	○	○	○	
N	21	Aluminum-wrought alloy	60		○	○	○	○	○	○	○
	22		100		○	○	○	○	○	○	○
	23	Aluminum-cast, alloyed	75		○	○	○	○	○	○	○
	24		90		○	○	○	○	○	○	○
	25		130		○	○	○	○	○	○	○
	26		110		○	○	○	○	○	○	○
	27	Copper and Copper Alloys (Bronze / Brass)	90		○	○	○	○	○	○	○
	28		100		○	○	○	○	○	○	○
	29		Non Metallic Materials Duroplastic, Fiber Reinforced Plastic, Graphite, CFRP, GFRP, etc.								
	30										
S	31	Heat Resistant Super Alloys	200	15	○	○	○	○	○	○	○
	32		280	30	○	○	○	○	○	○	○
	33		250	25	○	○	○	○	○	○	○
	34		350	38	○	○	○	○	○	○	○
	35	320	34	○	○	○	○	○	○	○	
	36	Titanium Alloys	400 Rm		○	○	○	○	○	○	○
	37		1050 Rm		○	○	○	○	○	○	○
H	38	Hardened steel	550	55							
	39		630	60							
	40	Chilled Cast Iron	400	42	○	○	○	○	○	○	○
	41	Hardened Cast Iron	550	55							

K-2								
G9634	G9B82	G9B83	G9B84	G9B85	G9424	G9G44	G9A68	G9444
4	2	2	4	4	2	2	2	2
30°	30°	30°	30°	30°	30°	30°	30°	≈ 30°
BALL NOSE	CORNER RADIUS	CORNER RADIUS	CORNER RADIUS	CORNER RADIUS	SQUARE	SQUARE	SQUARE	SQUARE
R1.0	D2.0	D3.0	D2.0	D3.0	D1.0	D3.0	D1.0	D2.0
R10.0	D12.0	D12.0	D12.0	D12.0	D20.0	D20.0	D20.0	D20.0
C522	C523	C525	C526	C528	C529	C530	C531	C532
SHORT LENGTH	SHORT LENGTH	LONG REACH	SHORT LENGTH	LONG REACH	SHORT LENGTH	SHORT LENGTH	SHORT LENGTH	SHORT LENGTH
TiAIN	TiAIN	TiAIN	TiAIN	TiAIN	TiAIN	TiAIN	TiAIN	TiAIN

◎	◎	◎	◎	◎	◎	◎	◎	◎	1
◎	◎	◎	◎	◎	◎	◎	◎	◎	2
◎	◎	◎	◎	◎	◎	◎	◎	◎	3
◎	◎	◎	◎	◎	◎	◎	◎	◎	4
◎	◎	◎	◎	◎	◎	◎	◎	◎	5
◎	◎	◎	◎	◎	◎	◎	◎	◎	6
◎	◎	◎	◎	◎	◎	◎	◎	◎	7
◎	◎	◎	◎	◎	◎	◎	◎	◎	8
◎	◎	◎	◎	◎	◎	◎	◎	◎	9
◎	◎	◎	◎	◎	◎	◎	◎	◎	10
◎	◎	◎	◎	◎	◎	◎	◎	◎	11
○	○	○	○	○	○	○	○	○	12
○	○	○	○	○	○	○	○	○	13
○	○	○	○	○	○	○	○	○	14
○	○	○	○	○	○	○	○	○	15
○	○	○	○	○	○	○	○	○	16
○	○	○	○	○	○	○	○	○	17
○	○	○	○	○	○	○	○	○	18
○	○	○	○	○	○	○	○	○	19
○	○	○	○	○	○	○	○	○	20
○	○	○	○	○	○	○	○	○	21
○	○	○	○	○	○	○	○	○	22
○	○	○	○	○	○	○	○	○	23
○	○	○	○	○	○	○	○	○	24
○	○	○	○	○	○	○	○	○	25
○	○	○	○	○	○	○	○	○	26
○	○	○	○	○	○	○	○	○	27
○	○	○	○	○	○	○	○	○	28
○	○	○	○	○	○	○	○	○	29
○	○	○	○	○	○	○	○	○	30
○	○	○	○	○	○	○	○	○	31
○	○	○	○	○	○	○	○	○	32
○	○	○	○	○	○	○	○	○	33
○	○	○	○	○	○	○	○	○	34
○	○	○	○	○	○	○	○	○	35
○	○	○	○	○	○	○	○	○	36
○	○	○	○	○	○	○	○	○	37
									38
									39
○	○	○	○	○	○	○	○	○	40
									41

SELECTION GUIDE



MILLING TOOLS

Please visit globalyg1.com/mat for material search

⊙ : Excellent
○ : Good

ISO	VDI 3323	Material Description	HB	HRc	
P	1	Non-alloy steel	125	13	
	2		190	25	
	3		250	28	
	4		270	32	
	5	300	10		
	6	180	29		
	7	275	32		
	8	300	38		
	9	350	15		
	10	200	35		
	11	325	Stainless steel	200	15
12	200	23			
13	240	10			
14	180	Grey cast iron	180	10	
15	180		26		
16	260		3		
17	160		25		
18	250	Nodular cast iron	130	21	
19	130		230	21	
20	230		Aluminum-wrought alloy	60	
21	100				
22	75	Aluminum-cast, alloyed		90	
23	90			130	
24	130			110	
25	90			90	
26	100	Copper and Copper Alloys (Bronze / Brass)		100	
27					
28					
29					
30		Non Metallic Materials (Duroplastic, Fiber Reinforced Plastic, Graphite, CFRP, GFRP, etc.)			
S	31	Heat Resistant Super Alloys	200	15	
	32		280	30	
	33		250	25	
	34		350	38	
	35		320	34	
	36	400 Rm	Titanium Alloys	1050 Rm	
	37	1050 Rm			
H	38	Hardened steel	550	55	
	39		630	60	
	40	Chilled Cast Iron	400	42	
	41	Hardened Cast Iron	550	55	

SERIES	K-2						
	G9527	G9445	G9G45	G9452	G9B80	G9410 G9553	G9G46
FLUTE	2	2	2	2	2	3	3
HELIX ANGLE	≈ 30°	≈ 30°	≈ 30°	30°	30°	30°	30°
CUTTING EDGE SHAPE	SQUARE	SQUARE	SQUARE	SQUARE	SQUARE	SQUARE	SQUARE
SIZE MIN	D3.5	D2.0	D3.0	D3.0	D0.4	D0.5	D3.0
SIZE MAX	D20.0	D20.0	D20.0	D20.0	D4.0	D20.0	D20.0
PAGE	C533	C534	C535	C537	C538	C541	C543
LENGTH	LONG LENGTH	LONG LENGTH	SHORT LENGTH	EXTRA LONG LENGTH	RIB PROCESSING	THROW AWAY	THROW AWAY
SURFACE TREATMENT	TiAIN	TiAIN	TiAIN	TiAIN	TiAIN	TiAIN	TiAIN

SERIES	K-2								
	G9425	G9G47	G9439	G9528	G9433	G9G48	G9447	G9G49	G9432
FLUTE	3	3	3	3	3	3	3	3	4
HELIX ANGLE	30°	30°	≈ 30°	≈ 30°	≈ 30°	≈ 30°	45°	45°	30°
CUTTING EDGE SHAPE	SQUARE	SQUARE	SQUARE	SQUARE	SQUARE	SQUARE	SQUARE	SQUARE	SQUARE
SIZE MIN	D1.0	D3.0	D2.0	D3.5	D3.0	D3.0	D3.0	D3.0	D1.0
SIZE MAX	D20.0	D20.0	D20.0	D20.0	D20.0	D20.0	D20.0	D20.0	D20.0
PAGE	C544	C545	C546	C547	C548	C549	C550	C551	C552
LENGTH	SHORT LENGTH	SHORT LENGTH	SHORT LENGTH	LONG LENGTH	LONG LENGTH	LONG LENGTH	LONG LENGTH	LONG LENGTH	SHORT LENGTH
SURFACE TREATMENT	TiAIN	TiAIN	TiAIN	TiAIN	TiAIN	TiAIN	TiAIN	TiAIN	TiAIN

SELECTION GUIDE



MILLING TOOLS

Please visit globalyg1.com/mat for material search

⊙ : Excellent
○ : Good

ISO	VDI 3323	Material Description	HB	HRC	K-2						
					G9G50	G9A69	G9448	G9540	G9449	G9G51	
P	1	Non-alloy steel	125	13	⊙	⊙	⊙	⊙	⊙	⊙	
	2		190	13	⊙	⊙	⊙	⊙	⊙	⊙	
	3		250	25	⊙	⊙	⊙	⊙	⊙	⊙	
	4		270	28	⊙	⊙	⊙	⊙	⊙	⊙	
	5	300	32	⊙	⊙	⊙	⊙	⊙	⊙		
	6	180	10	⊙	⊙	⊙	⊙	⊙	⊙		
	7	275	29	⊙	⊙	⊙	⊙	⊙	⊙		
	8	300	32	⊙	⊙	⊙	⊙	⊙	⊙		
	9	350	38	⊙	⊙	⊙	⊙	⊙	⊙		
	10	High alloyed steel, and tool steel	200	15	⊙	⊙	⊙	⊙	⊙	⊙	
	11	325	35	⊙	⊙	⊙	⊙	⊙	⊙	⊙	
M	12	Stainless steel	200	15	○	○	○	○	○	○	
	13		240	23	○	○	○	○	○	○	
K	14	Grey cast iron	180	10	○	○	○	○	○	○	
	15		260	26	○	○	○	○	○	○	
	16		160	3	○	○	○	○	○	○	
	17		250	25	○	○	○	○	○	○	
N	18	Nodular cast iron	130	21	○	○	○	○	○	○	
	19		230	21	○	○	○	○	○	○	
S	20	Malleable cast iron	230	21	○	○	○	○	○	○	
	21		Aluminum-wrought alloy	60		○	○	○	○	○	○
	22		100		○	○	○	○	○	○	
	23		Aluminum-cast, alloyed	75		○	○	○	○	○	○
	24		90		○	○	○	○	○	○	
	25		130		○	○	○	○	○	○	
	26		Copper and Copper Alloys (Bronze / Brass)	110		○	○	○	○	○	○
	27		90		○	○	○	○	○	○	
	28		100		○	○	○	○	○	○	
	29		Non Metallic Materials (Duropastic, Fiber Reinforced Plastic, Graphite, CFRP, GFRP, etc.)			○	○	○	○	○	○
H	30	Heat Resistant Super Alloys	200	15	○	○	○	○	○	○	
	31		280	30	○	○	○	○	○	○	
	32		250	25	○	○	○	○	○	○	
	33		350	38	○	○	○	○	○	○	
	34		320	34	○	○	○	○	○	○	
	35		400 Rm		○	○	○	○	○	○	
	36		1050 Rm		○	○	○	○	○	○	
H	37	Titanium Alloys	550	55							
	38		630	60							
	39		400	42	○	○	○	○	○	○	
	40		550	55	○	○	○	○	○	○	
	41	Hardened Cast Iron	550	55							

K-2						Only One			
G9H73 G9H74	G9H75 G9H76	G9453	G9F45 G9F46	G9A42	G9400	GYG77 GYF97	GYG72 GYF99	GYG01	GYG74 GYF96
4	4	4	4&6	Multi Flute	2	2	2	3	4
Multiple Helix	Multiple Helix	30°	30°	45°	30°	30°	30°	30°	30°
SQUARE	SQUARE	SQUARE	SQUARE	ROUGHING	DRILL MILL	BALL NOSE	SQUARE	SQUARE	SQUARE
D3.0	D3.0	D3.0	D3.0	D6.0	D3.0	R0.5	D1.0	D1.0	D1.0
D20.0	D20.0	D20.0	D20.0	D25.0	D20.0	R12.5	D25.0	D25.0	D25.0
C559	C560	C561	C562	C563	C564	C586	C587	C588	C589
SHORT LENGTH	LONG LENGTH	EXTRA LONG LENGTH	SHORT LENGTH LONG LENGTH	LONG LENGTH	-	SHORTLENGTH	SHORTLENGTH	SHORT LENGTH (Center Cut)	SHORT LENGTH (Center Cut)
X- Coating	X- Coating	TiAlN	TiAlN	X- Coating	TiAlN	Y-Coating	Y-Coating	Y-Coating	Y-Coating
						PM60	PM60	PM60	PM60

SELECTION GUIDE



MILLING TOOLS

Please visit globalyg1.com/mat for material search

◎ : Excellent
○ : Good

ISO	VDI 3323	Material Description	HB	HRC	Only One						Tank-Power	
					GYG52	GYG76 GYG02	GYF95	GYF94	GYF98	GYG03	E9940 GA940	E9A32 GAA32
P	1	Non-alloy steel	125	13	◎	◎	◎	◎	◎	◎	◎	◎
	2		190	13	◎	◎	◎	◎	◎	◎	◎	◎
	3		250	25	◎	◎	◎	◎	◎	◎	◎	◎
	4		270	28	◎	◎	◎	◎	◎	◎	◎	◎
	5	300	32	◎	◎	◎	◎	◎	◎	◎	◎	
	6	Low alloy steel	180	10	◎	◎	◎	◎	◎	◎	◎	◎
	7		275	29	◎	◎	◎	◎	◎	◎	◎	◎
	8		300	32	◎	◎	◎	◎	◎	◎	◎	◎
	9		350	38	○	○	○	○	○	○	○	○
	10		High alloyed steel, and tool steel	200	15	◎	◎	◎	◎	◎	◎	◎
	11	325		35	○	○	○	○	○	○	○	○
M	12	Stainless steel	200	15	◎	◎	◎	◎	◎	◎	◎	
13	240		23	◎	◎	◎	◎	◎	◎	◎	◎	
14	180		10	◎	◎	◎	◎	◎	◎	◎	◎	
K	15	Grey cast iron	180	10	◎	◎	◎	◎	◎	◎	◎	
	16		260	26	◎	◎	◎	◎	◎	◎	◎	
	17	Nodular cast iron	160	3	◎	◎	◎	◎	◎	◎	◎	
	18		250	25	◎	◎	◎	◎	◎	◎	◎	
	19		130	21	◎	◎	◎	◎	◎	◎	◎	
20	Malleable cast iron	230	21	◎	◎	◎	◎	◎	◎	◎		
N	21	Aluminum-wrought alloy	60									
	22		100									
	23		75									
	24	Aluminum-cast, alloyed	90									
	25		130									
	26		110	○	○	○	○	○	○	○	○	
	27	Copper and Copper Alloys (Bronze / Brass)	90		○	○	○	○	○	○	○	
	28		100	○	○	○	○	○	○	○	○	
	29											
	30	Non Metallic Materials Duroplastic, Fiber Reinforced Plastic, Graphite, CFRP, GFRP, etc.										
S	31	Heat Resistant Super Alloys	200	15								
	32		280	30								
	33		250	25								
	34		350	38								
	35	320	34									
	36	Titanium Alloys	400 Rm									
	37		1050 Rm									
H	38	Hardened steel	550	55								
	39		630	60								
	40	Chilled Cast Iron	400	42	○	○	○	○	○	○	○	
	41	Hardened Cast Iron	550	55								

Tank-Power												
E9936 GA936	E9A29 GAA29	E9942 GA942	E9A30 GAA30	E9938 GA938	E9A31 GAA31	E9941 GA941	E9A35 GAA35	E9A26 GAA26	E9A33 GAA33	E9A34 GAA34	E9E43 GAE43	
2	2	3	3	4	4	Multi Flute	Multi Flute	Multi Flute	Multi Flute	Multi Flute	Multi Flute	
30°	30°	30°	30°	30°	30°	30°	30°	45°	30°	30°	30°	
SQUARE	SQUARE	SQUARE	SQUARE	SQUARE	SQUARE	ROUGHING	ROUGHING	ROUGHING	ROUGHING	ROUGHING	ROUGHING	
D1.0	D1.0	D1.0	D1.0	D1.0	D2.0	D6.0	D6.0	D4.0	D6.0	D6.0	D10.0	
D25.0	D25.0	D25.0	D25.0	D25.0	D25.0	D25.0	D25.0	D25.0	D25.0	D25.0	D25.0	
C610	C611	C612	C613	C614	C615	C616	C617	C618	C619	C620	C621	
SHORT LENGTH	LONG LENGTH	STUB LENGTH	SHORT LENGTH	SHORT LENGTH	LONG LENGTH	SHORT LENGTH	LONG LENGTH	SHORT LENGTH	SHORT LENGTH	LONG LENGTH	WITH NECK	
TiAIN	TiAIN	TiAIN	TiAIN	TiAIN	TiAIN	X-Coating	X-Coating	X-Coating	X-Coating	X-Coating	X-Coating	
HSS-PM	HSS-PM	HSS-PM	HSS-PM	HSS-PM	HSS-PM	HSS-PM	HSS-PM	HSS-PM	HSS-PM	HSS-PM	HSS-PM	

SELECTION GUIDE



MILLING TOOLS

Please visit globalyg1.com/mat for material search

◎ : Excellent
○ : Good

ISO	VDI 3323	Material Description	HB	HRC
P	1	Non-alloy steel	125	13
	2		190	13
	3		250	25
	4		270	28
	5		300	32
	6	Low alloy steel	180	10
	7		275	29
	8		300	32
	9		350	38
	10		High alloyed steel, and tool steel	200
	11	325		35
M	12	Stainless steel	200	15
	13		240	23
	14		180	10
	15		180	10
K	16	Grey cast iron	260	26
	17	Nodular cast iron	160	3
	18		250	25
	19	Malleable cast iron	130	
	20		230	21
N	21	Aluminum-wrought alloy	60	
	22		100	
	23		75	
	24	Aluminum-cast, alloyed	90	
	25		130	
	26	Copper and Copper Alloys (Bronze / Brass)	110	
	27		90	
	28		100	
	29	Non Metallic Materials Duroplastic, Fiber Reinforced Plastic, Graphite, CFRP, GFRP, etc.		
	30			
S	31	Heat Resistant Super Alloys	200	15
	32		280	30
	33		250	25
	34		350	38
	35	320	34	
	36	Titanium Alloys	400 Rm	
	37		1050 Rm	
H	38	Hardened steel	550	55
	39		630	60
	40	Chilled Cast Iron	400	42
	41	Hardened Cast Iron	550	55

		HSS End mills							
SERIES		E2535	E2492	EL612	E2570	E2571	E2510	E2464	E2509
FLUTE		2	2	1	2	2	2	2	2
HELIX ANGLE		≈ 30°	≈ 30°	≈ 30°	≈ 30°	≈ 30°	30°	42°	42°
CUTTING EDGE SHAPE		BALL NOSE	BALL NOSE	SQUARE	SQUARE	SQUARE	SQUARE	SQUARE	SQUARE
SIZE MIN		R1.0	R1.0	D3.0	D1.0	D1.5	D2.5	D1.0	D2.0
SIZE MAX		R16.0	R15.0	D10.0	D40.0	D40.0	D40.0	D32.0	D20.0
PAGE		C643	C644	C645	C646	C649	C651	C653	C654
LENGTH		SHORT LENGTH	LONG LENGTH		SHORT LENGTH	LONG LENGTH	EXTRA LONG LENGTH	SHORT LENGTH	LONG LENGTH
SURFACE TREATMENT		Uncoated / TiAIN	Uncoated / TiAIN	Uncoated	Uncoated / TiAIN	Uncoated / TiAIN	Uncoated / TiAIN	Uncoated	Uncoated
Tool Material		HSS Co8	HSS Co8	HSS-E	HSS Co8	HSS Co8	HSS Co8	HSS Co8	HSS Co8



HSS

		HSS End mills													
		E2572	E2573	E2516	E2553	E2SET553	E2554	E2574	E2595	E2597	E2753	E2762	E2755	E2751	E2752
FLUTE		3	3	3	3	3	3	4	4	4&6	Multi Flute	Multi Flute	3	Multi Flute	Multi Flute
HELIX ANGLE		≈ 30°	≈ 30°	30°	30°	30°	30°	≈ 30°	≈ 30°	45°	30°	30°	37°	30°	30°
CUTTING EDGE SHAPE		SQUARE	SQUARE	SQUARE	SQUARE	SQUARE	SQUARE	SQUARE	SQUARE	SQUARE	SQUARE ROUGHING	SQUARE ROUGHING	SQUARE ROUGHING	SQUARE ROUGHING	SQUARE ROUGHING
SIZE MIN		D1.5	D1.0	D2.0	D1.0	D2.0	D1.5	D2.0	D2.0	D2.0	D6.0	D6.0	D6.0	D6.0	D6.0
SIZE MAX		D32.0	D40.0	D40.0	D20.0	D10.0	D10.0	D20.0	D25.0	D20.0	D40.0	D40.0	D30.0	D50.0	D40.0
PAGE		C655	C656	C658	C660	C661	C662	C663	C664	C665	C666	C667	C668	C669	C671
LENGTH		STUB LENGTH	SHORT LENGTH	LONG LENGTH	SHORT LENGTH THROW AWAY	THROW AWAY SET	LONG LENGTH THROW AWAY	SHORT LENGTH	SHORT LENGTH CENTER CUTTING	LONG LENGTH CENTER CUTTING	SHORT LENGTH	LONG LENGTH	SHORT LENGTH	SHORT LENGTH	LONG LENGTH
SURFACE TREATMENT		Uncoated / TiAIN	Uncoated / TiAIN	Uncoated / TiAIN	Uncoated / TiAIN	Uncoated	Uncoated / TiAIN	Uncoated / TiAIN	Uncoated / TiAIN	Uncoated / TiAIN	Uncoated / TiAIN	Uncoated / TiAIN	Uncoated	Uncoated / TiAIN	Uncoated / TiAIN
Tool Material		HSS Co8	HSS Co8	HSS Co8	HSS Co8	HSS Co8	HSS Co8	HSS Co8	HSS Co8	HSS Co8	HSS Co8	HSS Co8	HSS Co8	HSS Co8	HSS Co8



SELECTION GUIDE



MILLING TOOLS

SERIES

FLUTE

HELIX ANGLE
CUTTING EDGE
SHAPE

SIZE MIN

SIZE MAX

PAGE

LENGTH

SURFACE TREATMENT

Milling Cutting					
ML012, ML022 ML112, ML122	ML032, ML042 ML132, ML142	ML062, ML162	ML072, ML172	ML092	ML102
-	-	-	-	-	-
0°	0°	10°-20°	10°-20°	10°	-
DOVETAIL CUTTERS	DOVETAIL CUTTERS	WOODRUFF KEYSEAT CUTTERS	T-SLOT CUTTERS	SIDE AND FACE MILLING CUTTERS	SIDE AND FACE MILLING CUTTERS
D16.0	D16.0	D10.5	D12.5	D50.0	D50.0
D50.0	D38.0	D45.5	D40.0	D125.0	D200.0
C706	C707	C708	C709	C711	C713
Type A, C, E	Type B, D, F	Type B, D, F	Type AA, AB, AD	with STRAIGHT TEETH	with STAGGERED TEETH
Uncoated	Uncoated	Uncoated	Uncoated	Uncoated	Uncoated
HSS-E	HSS-E	HSS-E	HSS-E	HSS-E	HSS-E



Please visit
globalyg1.com/mat
for material search

◎ : Excellent
○ : Good

ISO	VDI 3323	Material Description	HB	HRc							
P	1	Non-alloy steel	125	13	◎	◎	◎	◎	◎	◎	
	2		190	13	◎	◎	◎	◎	◎	◎	
	3		250	25	◎	◎	◎	◎	◎	◎	
	4		270	28	◎	◎	◎	◎	◎	◎	
	5		300	32	◎	◎	◎	◎	◎	◎	
	6	Low alloy steel	180	10	◎	◎	◎	◎	◎	◎	
	7		275	29	◎	◎	◎	◎	◎	◎	
	8		300	32	◎	◎	◎	◎	◎	◎	
	9		350	38	○	○	○	○	○	○	
	10		High alloyed steel, and tool steel	200	15	◎	◎	◎	◎	◎	◎
	11	325		35	○	○	○	○	○	○	
M	12	Stainless steel	200	15							
	13		240	23							
	14		180	10							
K	15	Grey cast iron	180	10							
	16		260	26							
	17	Nodular cast iron	160	3							
	18		250	25							
	19		130								
20	Malleable cast iron	230	21								
N	21	Aluminum- wrought alloy	60		○	○	○	○	○	○	
	22		100		○	○	○	○	○	○	
	23	Aluminum-cast, alloyed	75		○	○	○	○	○	○	
	24		90		○	○	○	○	○	○	
	25		130		○	○	○	○	○	○	
	26		110								
	27		90								
	28		100								
	29		Non Metallic Materials Duroplastic, Fiber Reinforced Plastic, Graphite, CFRP, GFRP, etc.								
	30										
S	31	Heat Resistant Super Alloys	200	15							
	32		280	30							
	33		250	25							
	34		350	38							
	35	320	34								
	36	Titanium Alloys	400 Rm								
	37		1050 Rm								
H	38	Hardened steel	550	55							
	39		630	60							
	40	Chilled Cast Iron	400	42							
	41	Hardened Cast Iron	550	55							

HSS

CBN
END MILLS

i-Xmill
END MILLS

i-SMART
MODULAR
END MILLS

X5070
END MILLS

4G MILL
END MILLS

X-POWER
PRO
END MILLS

TitaNox-
POWER
END MILLS

JET-POWER
END MILLS

V7 PLUS
END MILLS

ALU-POWER
HPC
END MILLS

ALU-
POWER
END MILLS

D-POWER
GRAPHITE
END MILLS

CRX S
END MILLS

K-2
END MILLS

ONLY ONE
COATED PM60
END MILLS

TANK-
POWER
END MILLS

GENERAL
HSS
END MILLS

MILLING
CUTTERS

TECHNICAL
DATA

Milling Cutting					
E2675	E2676	E2677	E2678	E2679	E2498
Multi Flute	Multi Flute	Multi Flute	Multi Flute	Multi Flute	4
30°	42°	30°	30°	30°	0°
SHELL END MILL	SHELL END MILL	ROUGHING SHELL END MILL	ROUGHING SHELL END MILL	ROUGHING & FINISHING SHELL END MILL	CORNER ROUNDING CUTTERS
D30.0	D30.0	D40.0	D40.0	D40.0	D8.0
D160.0	D100.0	D160.0	D160.0	D160.0	D56.0
C719	C720	C721	C722	C723	C724
-	for ALUMINUM	-	-	-	-
Uncoated	Uncoated	Uncoated	Uncoated	Uncoated	Uncoated
HSS Co8	HSS Co8	HSS Co8	HSS Co8	HSS Co8	HSS Co8



◎	○	◎	◎	◎	◎	1
◎	○	◎	◎	◎	◎	2
◎	○	◎	◎	◎	◎	3
◎	○	◎	◎	◎	◎	4
◎	○	◎	○	○	○	5
◎	○	◎	◎	◎	◎	6
◎	○	◎	◎	◎	◎	7
◎	○	◎	○	○	○	8
◎	○	◎	◎	◎	◎	9
◎	○	◎	◎	◎	◎	10
○	○	○	○	○	○	11
						12
						13
						14
						15
						16
						17
						18
						19
						20
	◎	○	○	○	○	21
	◎	○	○	○	○	22
	◎	○	○	○	○	23
	◎	○	○	○	○	24
	◎	○	○	○	○	25
						26
						27
						28
						29
						30
						31
						32
						33
						34
						35
						36
						37
						38
						39
						40
						41



Global Cutting Tool Leader **YG-1**



MILLING



Leading Through Innovation

CBN

CBN (Cubic Boron Nitride)

CBN FRÄSER

- CBN(Cubic Boron Nitride) Machining High Hardened Steels up to HRc70 Mirror Finish
- CBN (Kubisches Bornitrid) zur Bearbeitung von hochgehärteten Stählen bis HRc70 Hochglanzoberfläche

SELECTION GUIDE



CBN
END MILLS

Cubic Boron Nitride,
Machining High Hardened Steels
up to HRC70, Mirror Finish



◎ : Excellent ○ : Good

Recommended cutting conditions : p. C37

ISO	VDI 3323	Material Description	Composition / Structure / Heat Treatment	HB	HRC
P	1	Non-alloy steel	About 0.15% C Annealed	125	
	2		About 0.45% C Annealed	190	13
	3		About 0.45% C Quenched & Tempered	250	25
	4		About 0.75% C Annealed	270	28
	5		About 0.75% C Quenched & Tempered	300	32
	6	Low alloy steel	Annealed	180	10
	7		Quenched & Tempered	275	29
	8		Quenched & Tempered	300	32
	9		Quenched & Tempered	350	38
	10		High alloyed steel, and tool steel	Annealed	200
	11	Quenched & Tempered	325	35	
M	12	Stainless steel	Ferritic / Martensitic Annealed	200	15
	13		Martensitic Quenched & Tempered	240	23
	14		Austenitic	180	10
K	15	Grey cast iron	Pearlitic / ferritic	180	10
	16		Pearlitic (Martensitic)	260	26
	17	Nodular cast iron	Ferritic	160	3
	18		Pearlitic	250	25
	19		Ferritic	130	
	20	Malleable cast iron	Pearlitic	230	21
N	21	Aluminum-wrought alloy	Not Curable	60	
	22		Curable Hardened	100	
	23	Aluminum-cast, alloyed	≤ 12% Si, Not Curable	75	
	24		≤ 12% Si, Curable Hardened	90	
	25		> 12% Si, Not Curable	130	
	26		Copper and Copper Alloys (Bronze / Brass)	CuZn, CuSnZn (Brass)	90
	27	Non Metallic Materials	Cutting Alloys, PB>1%	110	
	28		CuSn, lead-free copper and electrolytic copper	100	
	29		Duroplastic, Fiber Reinforced Plastic		
	30	Rubber, Wood, etc.			
S	31	Heat Resistant Super Alloys	Fe Based Annealed	200	15
	32		Cured	280	30
	33		Annealed	250	25
	34		Cured	350	38
	35		Cast	320	34
	36	Titanium Alloys	Pure Titanium	400 Rm	
	37		Alpha + Beta Alloys Hardened	1050 Rm	
H	38	Hardened steel	Hardened	550	55
	39		Hardened	630	60
	40	Chilled Cast Iron	Cast	400	42
	41	Hardened Cast Iron	Hardened	550	55

SERIES	ESB94	ESD02
FLUTE	2	2
HELIX ANGLE	30°	0°
CUTTING EDGE SHAPE	BALL NOSE	CORNER RADIUS
SIZE MIN	R0.2	D0.5
SIZE MAX	R1.5	D2.0
PAGE	C35	C36
	UNCOATED	UNCOATED



PLAIN SHANK **ESB94** SERIES

CBN, 2 FLUTE BALL NOSE

- CBN, 2 SCHNEIDEN STIRNRADIUS
- CBN, fraise 2 dents, hémisphérique
- CBN, 2 TAGLIENTI, SEMISFERICA

- Achieves stable machining and higher accuracy for duration.
- Saves setting time and cost from the reduction of frequent tool change.
- Improves repeatability in performance.
- Special designed geometry improving tool rigidity at High Speed Cutting.
- Tighter Radius Tolerance of ±0.005mm and higher accuracy with longer tool life.

- Sichert dauerhaft stabile Bearbeitung und höhere Genauigkeit.
- Spart Rüstzeit und -kosten durch weniger Werkzeugwechsel.
- Verbessert die Wiederholgenauigkeit.
- Eine besondere Werkzeuggeometrie verbessert die Steifigkeit bei HSC-Bearbeitung.
- Engere Radiustoleranz ±0.005, höhere Genauigkeit und längere Werkzeuglebenszeit.

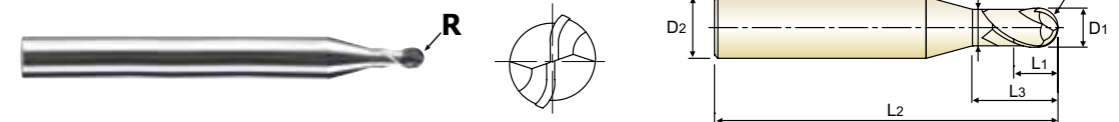

Plain Shank	Page
HYDRAULIC CHUCK SHRINK FIT HOLDER	D15-46 D47-72
POWER MILLING CHUCK	D161-176
ER COLLET CHUCK SK SLIM CHUCK	D73-116 D183-201

EDP No.	Radius of Ball Nose	Mill Diameter	Shank Diameter	Length of Cut	Length Below Shank	Overall Length	Neck Diameter
	R (±0.005)	D1	D2	L1	L3	L2	D3
ESB94004012	R0.2	0.4	4	0.3	1.2	50	0.37
ESB94005015	R0.25	0.5	4	0.4	1.5	50	0.46
ESB94006015	R0.3	0.6	4	0.5	1.5	50	0.56
ESB94008020	R0.4	0.8	4	0.6	2	50	0.76
ESB94010025	R0.5	1.0	4	0.6	2.5	50	0.95
ESB94010040	R0.5	1.0	4	0.6	4	50	0.95
ESB94010060	R0.5	1.0	4	0.6	6	50	0.95
ESB94012030	R0.6	1.2	4	0.8	3	50	1.15
ESB94015030	R0.75	1.5	4	0.95	3	50	1.45
ESB94015040	R0.75	1.5	4	0.95	4	50	1.45
ESB94015060	R0.75	1.5	4	0.95	6	50	1.45
ESB94020050	R1.0	2.0	4	1.2	5	50	1.95
ESB94020060	R1.0	2.0	4	1.2	6	50	1.95
ESB94030060	R1.5	3.0	4	1.8	6	50	2.85

Radius Tolerance(Mm)	Shank Dia. Tolerance
± 0.005	h5

ISO	P										M				K					
	Non-alloy steel					Low alloy steel					High alloyed steel, and tool steel		Stainless steel		Grey cast iron		Nodular cast iron		Malleable cast iron	
Material Description	1	2	3	4	5	6	7	8	9	10	11	12	13	14	15	16	17	18	19	20
VDI 3323	1	2	3	4	5	6	7	8	9	10	11	12	13	14	15	16	17	18	19	20
HRC	125	13	25	28	32	10	29	32	38	15	35	15	23	10	10	26	3	25	42	21
HB	190	250	270	300	350	180	275	300	350	200	325	200	240	180	180	260	160	250	130	230
Recommend																				

ISO	N					S					H										
	Aluminum-wrought alloy		Aluminum-cast, alloyed			Copper and Copper Alloys (Bronze / Brass)		Non Metallic Materials			Heat Resistant Super Alloys		Titanium Alloys	Hardened steel	Chilled Cast Iron	Hardened Cast Iron					
Material Description	21	22	23	24	25	26	27	28	29	30	31	32	33	34	35	36	37	38	39	40	41
VDI 3323	21	22	23	24	25	26	27	28	29	30	31	32	33	34	35	36	37	38	39	40	41
HRC	60	100	75	90	130	110	90	100			200	280	250	350	320	400 Rm	1050 Rm	550	630	400	550
HB																					
Recommend																		◎	◎		◎



PLAIN SHANK **ESD02** SERIES

CBN, 2 FLUTE CORNER RADIUS

- CBN, 2 SCHNEIDEN ECKENRADIUS
- CBN, fraise 2 dents, torique
- CBN, 2 TAGLIENTI, TORICA

- Achieves stable machining and higher accuracy for duration.
- Saves setting time and cost from the reduction of frequent tool change.
- Improves repeatability in performance.
- Special designed geometry improving tool rigidity at High Speed Cutting.
- Tighter Radius Tolerance of ±0.005mm and higher accuracy with longer tool life.

- Sichert dauerhaft stabile Bearbeitung und höhere Genauigkeit.
- Spart Rüstzeit und -kosten durch weniger Werkzeugwechsel.
- Verbessert die Wiederholgenauigkeit.
- Eine besondere Werkzeuggeometrie verbessert die Steifigkeit bei HSC-Bearbeitung.
- Engere Radiustoleranz ± 0.005, höhere Genauigkeit und längere Werkzeuglebenszeit.

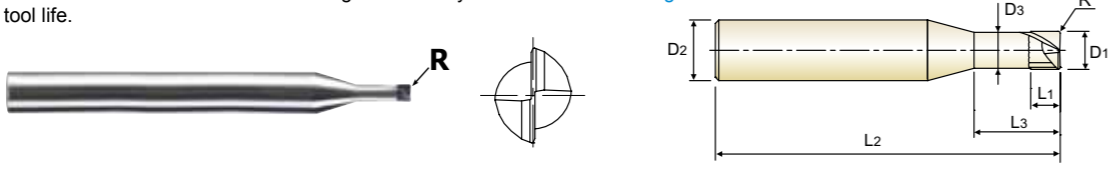

CBN 2 0° ±0.005 PLAIN UNCOATED p. C37

Plain Shank Page
 HYDRAULIC CHUCK SHRINK FIT HOLDER D15-46 D47-72
 POWER MILLING CHUCK D161-176
 ER COLLET CHUCK SK SLIM CHUCK D73-116 D183-201
 Recommended Toolholder

Unit : mm

EDP No.	Corner Radius	Mill Diameter	Shank Diameter	Length of Cut	Length Below Shank	Overall Length	Neck Diameter
	R (±0.005)	D1	D2	L1	L3	L2	D3
ESD02005052	R0.05	0.5	4	0.3	2	50	0.46
ESD02005053	R0.05	0.5	4	0.3	3	50	0.46
ESD02010053	R0.05	1.0	4	0.7	3	50	0.95
ESD02010055	R0.05	1.0	4	0.7	5	50	0.95
ESD02010103	R0.1	1.0	4	0.7	3	50	0.95
ESD02010105	R0.1	1.0	4	0.7	5	50	0.95
ESD02015105	R0.1	1.5	4	1.0	5	50	1.45
ESD02015108	R0.1	1.5	4	1.0	8	50	1.45
ESD02015205	R0.2	1.5	4	1.0	5	50	1.45
ESD02015208	R0.2	1.5	4	1.0	8	50	1.45
ESD02020106	R0.1	2.0	4	1.2	6	50	1.95
ESD02020100	R0.1	2.0	4	1.2	10	50	1.95
ESD02020206	R0.2	2.0	4	1.2	6	50	1.95
ESD02020200	R0.2	2.0	4	1.2	10	50	1.95

Corner Radius(mm)	Shank Dia. Tolerance
± 0.005	h5

◎ : Excellent ○ : Good

ISO	P											M				K				
	Non-alloy steel					Low alloy steel						High alloyed steel and tool steel				Stainless steel		Grey cast iron	Nodular cast iron	
Material Description	1	2	3	4	5	6	7	8	9	10	11	12	13	14	15	16	17	18	19	20
VDI 3323																				
HRc																				
HB	125	190	250	28	300	10	29	32	38	15	35	15	23	10	10	26	3	25	21	
Recommend																				

ISO	N								S							H					
	Aluminum-wrought alloy				Aluminum-cast, alloyed				Copper and Copper Alloys (Bronze / Brass)		Non Metallic Materials		Heat Resistant Super Alloys					Titanium Alloys		Hardened steel	Chilled Cast Iron
Material Description	21	22	23	24	25	26	27	28	29	30	31	32	33	34	35	36	37	38	39	40	41
VDI 3323																					
HRc																					
HB	60	100	75	90	130	110	90	100			15	30	25	38	34			55	60	42	55
Recommend											200	280	250	350	320	400 Rm	1050 Rm	◎	◎		◎



**RECOMMENDED CUTTING CONDITIONS
EMPFOHLENE SCHNEIDPARAMETER**

Vc = m/min.
fz = mm/tooth
RPM = rev./min.
FEED = mm/min.

ESB94 SERIES 2 FLUTE BALL NOSE

ISO	VDI 3323	Material Description	Ae	Ap	Parameter	Diameter (Ø)										
						0.4	0.5	0.6	0.8	1.0	1.2	1.5	2.0	3.0		
H	38	Hardened steel	0.5D	0.2R	Vc	65	80	95	125	155	190	235	250	250		
					fz	0.012	0.015	0.02	0.02	0.03	0.03	0.03	0.04	0.04		
	RPM		51725	50930	50399	49736	49338	50399	49869	39789	26526					
	FEED		1241	1528	2016	1989	2960	3024	2992	3183	2122					
	39.1		0.5D	0.1R	Vc	65	80	95	125	155	190	235	250	250		
					fz	0.012	0.015	0.02	0.02	0.03	0.03	0.03	0.04	0.04		
	39.2		0.5D	0.1R	Vc	65	80	95	125	155	190	235	200	205		
					fz	0.012	0.015	0.02	0.02	0.03	0.03	0.03	0.039	0.04		
	39.3		R0.2~R0.4=0.005mm R0.5~R1.5=0.01mm	R0.2~R0.4=0.005mm R0.5~R1.5=0.01mm	Vc	65	80	95	125	155	190	235	200	205		
					fz	0.012	0.015	0.02	0.02	0.03	0.03	0.03	0.039	0.04		
H	41	Hardened Cast Iron	0.5D	0.2R	Vc	65	80	95	125	155	190	235	250	250		
					fz	0.012	0.015	0.02	0.02	0.03	0.03	0.03	0.04	0.04		
	RPM		51725	50930	50399	49736	49338	50399	49869	39789	26526					
	FEED		1241	1528	2016	1989	2960	3024	2992	3183	2122					

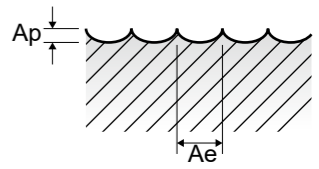

ESD02 SERIES 2 FLUTE CORNER RADIUS

ISO	VDI 3323	Material Description	Parameter	Diameter (Ø)								
				0.5	1.0	1.5	2.0					
H	38 39.1	Hardened steel	Vc	80	135	140	140					
			fz	0.007	0.012	0.017	0.02					
	RPM		50930	42972	29709	22282						
	FEED		713	1031	1010	891						
	Ae		0.1	0.2	0.4	0.6						
	Ap		0.01	0.01	0.02	0.03						
	39.2 39.3		0.006	50930	611	0.06	0.005	0.01	0.01	0.02	0.03	0.03
	H		41	Hardened Cast Iron	Vc	80	135	140	140			
					fz	0.007	0.012	0.017	0.02			
RPM		50930			42972	29709	22282					
FEED		713			1031	1010	891					
Ae		0.1			0.2	0.4	0.6					
Ap		0.01			0.01	0.02	0.03					

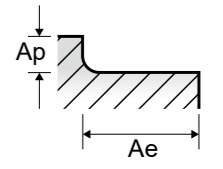



Global Cutting Tool Leader **YG-1**



MILLING



Leading Through Innovation



CARBIDE INSERT & HOLDER

i-Xmill END MILLS

i-Xmills, HM-Wendeplatten Fräser

- Various Applications Type of Inserts Available for General Steels, Pre-Hardened Steels, High Hardened Steels, Stainless Steels and Graphite
- Für die verschiedensten Anwendungen sind Wendeplatten verfügbar, für allgemeine Stähle, vorgehärtete Stähle, hochgehärtete Stähle, rostfreie Stähle und Graphit

SELECTION GUIDE



CARBIDE INSERT & HOLDER **i-Xmill** END MILLS

Available for General Steels, Pre-Hardened Steels, High Hardened Steels, Stainless Steel and Graphite

Please visit globalyg1.com/mat for material search

◎ : Excellent ○ : Good

Recommended cutting conditions : p. C60

SERIES	XMB110A	XMB120C	XMB260T	XMB130A
FLUTE	2	2	2	2
HELIX ANGLE	-	-	-	-
CUTTING EDGE SHAPE	BALL NOSE	BALL NOSE	BALL NOSE	BALL NOSE
SIZE MIN	R4.0	R4.0	R4.0	R4.0
SIZE MAX	R16.5	R16.5	R16.5	R16.5
PAGE	C42	C42	C42	C43

	AITiN	X-Coating	Z-Coating	AITiN
GENERAL PURPOSE	PRE-HARDENED STEELS	HIGH HARDENED STEELS	STAINLESS STEELS	



ISO	VDI 3323	Material Description	Composition / Structure / Heat Treatment	HB	HRc					
P	1	Non-alloy steel	About 0.15% C Annealed	125		◎				
	2		About 0.45% C Annealed	190	13	◎				
	3		About 0.45% C Quenched & Tempered	250	25	◎				
	4		About 0.75% C Annealed	270	28	◎				
	5		About 0.75% C Quenched & Tempered	300	32	◎				
	6	Low alloy steel	Annealed	180	10	◎				
	7		Quenched & Tempered	275	29	◎				
	8		Quenched & Tempered	300	32	◎				
	9		Quenched & Tempered	350	38		◎			
	10		High alloyed steel, and tool steel	Annealed	200	15		○		
	11	Quenched & Tempered		325	35		◎			
M	12	Stainless steel	Ferritic / Martensitic Annealed	200	15				◎	
	13		Martensitic Quenched & Tempered	240	23				◎	
	14		Austenitic	180	10				◎	
	15		Pearlitic / ferritic	180	10			◎		
K	16	Grey cast iron	Pearlitic (Martensitic)	260	26			◎		
	17		Ferritic	160	3			◎		
	18		Nodular cast iron	Pearlitic	250	25			◎	
	19		Ferritic	130				◎		
	20		Malleable cast iron	Pearlitic	230	21			◎	
N	21	Aluminum-wrought alloy	Not Curable	60					○	
	22		Curable Hardened	100					○	
	23	Aluminum-cast, alloyed	≤ 12% Si, Not Curable	75					○	
	24		≤ 12% Si, Curable Hardened	90					○	
	25		> 12% Si, Not Curable	130					○	
	26		Copper and Copper Alloys (Bronze / Brass)	CuZn, CuSnZn (Brass)	90					○
	27	Non Metallic Materials	Cutting Alloys, PB>1%	110						
	28		CuSn, lead-free copper and electrolytic copper	100						
	29		Duroplastic, Fiber Reinforced Plastic							
	30	Rubber, Wood, etc.								
S	31	Heat Resistant Super Alloys	Fe Based Annealed	200	15					
	32		Cured	280	30					
	33		Annealed	250	25					
	34		Cured	350	38					
	35	Cast	320	34						
	36	Titanium Alloys	Pure Titanium	400 Rm						
37	Alpha + Beta Alloys Hardened		1050 Rm							
H	38	Hardened steel	Hardened	550	55			○		
	39		Hardened	630	60			◎		
	40		Cast	400	42			○		
	41		Hardened	550	55			◎		

XMM110V	XMB110D	XMR110A	XMR120C	XMR260T	XMF110V	XMR110D	ZBC	ZBS	ZBT	ZRC	ZRS	ZRT
2	2	2	2	2	2	2	-	-	-	-	-	-
-	-	-	-	-	-	-	-	-	-	-	-	-
BALL NOSE	BALL NOSE	CORNER RADIUS	CORNER RADIUS	CORNER RADIUS	CORNER RADIUS	CORNER RADIUS	BALL NOSE	BALL NOSE	BALL NOSE	CORNER RADIUS	CORNER RADIUS	CORNER RADIUS
R4.0	R4.0	D8.0	D8.0	D8.0	D8.0	D8.0	-	-	-	-	-	-
R16.5	R16.5	D33.0	D33.0	D33.0	D33.0	D33.0	-	-	-	-	-	-
C43	C43	C44	C44	C44	C49	C49	C54	C55	C56	C57	C58	C58
FULL RADIUS	-	-	-	-	HIGH FEED	-	STRAIGHT NECK	STRAIGHT NECK	TAPER NECK	STRAIGHT NECK	STRAIGHT NECK	TAPER NECK
Y-Coating	Diamond	AITiN	X-Coating	Z-Coating	Y-Coating	Diamond	Carbide	Steel	Steel	Carbide	Steel	Steel
GENERAL PURPOSE	GRAPHITE	GENERAL PURPOSE STAINLESS STEELS	PRE-HARDENED STEELS	HIGH HARDENED STEELS	GENERAL PURPOSE	GRAPHITE						
◎		◎			◎							1
◎		◎			◎							2
◎		◎			◎							3
◎		◎			◎							4
◎		◎			◎							5
◎		◎			◎							6
◎		◎			◎							7
◎		◎			◎							8
◎		◎			◎							9
◎		◎			◎							10
◎		◎			◎							11
		◎										12
		◎										13
		◎										14
		◎										15
		◎										16
		◎										17
		◎										18
		◎										19
		◎										20
	○					○						21
	○					○						22
	○					○						23
	○					○						24
												25
												26
												27
												28
	◎					◎						29
												30
												31
												32
												33
												34
												35
												36
												37
												38
												39
												40
												41



XMB110A SERIES
XMB120C SERIES
XMB260T SERIES

i-Xmill BALL INSERTS

- i-Xmill WECHSELPLATTE mit RUNDER STIRN
- i-Xmill - Plaquette hémisphérique
- i-Xmill Placca emisferica

- ▶ Indexable Ball End Mill for economic use
- ▶ Three Types of Inserts are available
 - For General Purpose (~HRc50)
 - For Hardened Material (HRc40~HRc65)
 - For Graphite
- ▶ Special Geometry and Coating for Excellent Performance

- ▶ Kopierfräser mit Wechselplatte für wirtschaftlichen Einsatz.
- ▶ Drei Typen von Schneideinsätzen lieferbar
 - Für allgemeinen Einsatz (HRc50)
 - Für gehärtete Materialien (HRc40~HRc65)
 - Für Graphit
- ▶ Spezielle Geometrie und Beschichtung für höchste Leistu



cutting conditions : p.C60

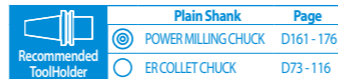

EDP No.			Radius of Ball Nose	Mill Diameter	Height	Thickness
AITIN	X-Coating	Z-Coating				
For General Purpose	For Pre-Hardened Steels	For High Hardened Steels	R	D	H	T
XMB110A080	XMB120C080	XMB260T080	R4.0	8.0	8.0	2.4
XMB110A100	XMB120C100	XMB260T100	R5.0	10.0	9.5	2.7
XMB110A110	XMB120C110	XMB260T110	R5.5	11.0	10.0	2.7
XMB110A120	XMB120C120	XMB260T120	R6.0	12.0	11.0	3.2
XMB110A130	XMB120C130	XMB260T130	R6.5	13.0	11.5	3.2
XMB110A160	XMB120C160	XMB260T160	R8.0	16.0	13.0	4.2
XMB110A170	XMB120C170	XMB260T170	R8.5	17.0	13.5	4.2
XMB110A200	XMB120C200	XMB260T200	R10.0	20.0	16.0	5.2
XMB110A210	XMB120C210	XMB260T210	R10.5	21.0	16.5	5.2
XMB110A250	XMB120C250	XMB260T250	R12.5	25.0	19.5	6.2
XMB110A260	XMB120C260	XMB260T260	R13.0	26.0	20.0	6.2
XMB110A300	XMB120C300	XMB260T300	R15.0	30.0	23.5	7.2
XMB110A320	XMB120C320	XMB260T320	R16.0	32.0	24.5	7.2
XMB110A330	XMB120C330	XMB260T330	R16.5	33.0	25.0	7.2

▶ The ball radius tolerance is ±0.01mm and the set-up accuracy is ±0.02mm.

◎ : Excellent ○ : Good

ISO	P										M				K					
	Non-alloy steel					Low alloy steel					High alloyed steel, and tool steel	Stainless steel		Grey cast iron		Nodular cast iron		Malleable cast iron		
Material Description	1	2	3	4	5	6	7	8	9	10	11	12	13	14	15	16	17	18	19	20
VDI 3323	1	2	3	4	5	6	7	8	9	10	11	12	13	14	15	16	17	18	19	20
HRc	13	25	28	32	38	10	29	32	38	45	15	23	10	10	26	3	25	3	25	
HB	125	190	250	270	300	180	275	300	350	200	325	200	240	180	180	260	160	250	130	230
XMB110A	◎	◎	◎	◎	◎	◎	◎	◎	◎	◎					◎	◎	◎	◎	◎	◎
XMB120C																				
XMB260T																				

ISO	N						S					H									
	Aluminum-wrought alloy		Aluminum-cast, alloyed		Copper and Copper Alloys (Bronze / Brass)		Non Metallic Materials			Heat Resistant Super Alloys		Titanium Alloys		Hardened steel	Chilled Cast Iron	Hardened Cast Iron					
Material Description	21	22	23	24	25	26	27	28	29	30	31	32	33	34	35	36	37	38	39	40	41
VDI 3323	21	22	23	24	25	26	27	28	29	30	31	32	33	34	35	36	37	38	39	40	41
HRc	21	22	23	24	25	26	27	28	29	30	31	32	33	34	35	36	37	38	39	40	41
HB	60	100	75	90	130	110	90	100			200	280	250	350	320	400 Rm	1050 Rm	550	630	400	550
XMB110A																					
XMB120C																					
XMB260T																					



XMB130A SERIES
XMM110V SERIES
XMB110D SERIES

i-Xmill BALL INSERTS

- i-Xmill WECHSELPLATTE mit RUNDER STIRN
- i-Xmill - Plaquette hémisphérique
- i-Xmill Placca emisferica

- ▶ Indexable Ball End Mill for economic use
- ▶ Three Types of Inserts are available
 - For General Purpose (~HRc50)
 - For Hardened Material (HRc40~HRc65)
 - For Graphite
- ▶ Special Geometry and Coating for Excellent Performance

- ▶ Kopierfräser mit Wechselplatte für wirtschaftlichen Einsatz.
- ▶ Drei Typen von Schneideinsätzen lieferbar
 - Für allgemeinen Einsatz (HRc50)
 - Für gehärtete Materialien (HRc40~HRc65)
 - Für Graphit
- ▶ Spezielle Geometrie und Beschichtung für höchste Leistu

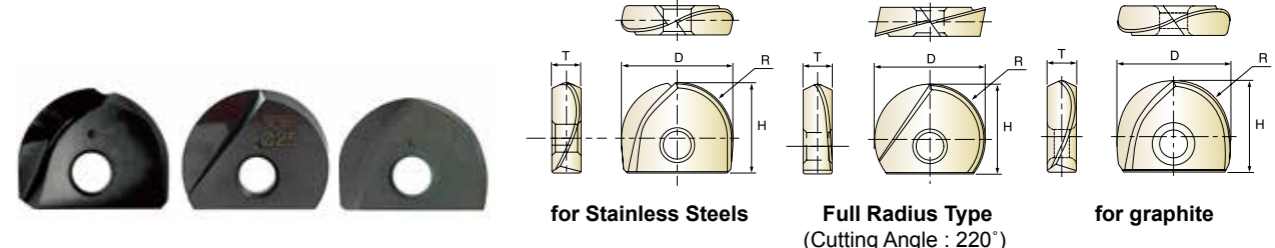

cutting conditions : p.C60

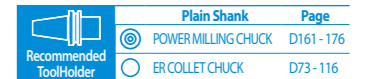

EDP No.			Radius of Ball Nose	Mill Diameter	Height	Thickness
AITIN	Y-Coating	Diamond				
For Stainless Steels	For General Purpose Full Radius Type	For Graphite	R	D	H	T
XMB130A080	XMM110V080	XMB110D080	R4.0	8.0	8.0	2.4
XMB130A100	XMM110V100	XMB110D100	R5.0	10.0	9.5	2.7
XMB130A110	XMM110V110	XMB110D110	R5.5	11.0	10.0	2.7
XMB130A120	XMM110V120	XMB110D120	R6.0	12.0	11.0	3.2
XMB130A130	XMM110V130	XMB110D130	R6.5	13.0	11.5	3.2
XMB130A160	XMM110V160	XMB110D160	R8.0	16.0	13.0	4.2
XMB130A170	XMM110V170	XMB110D170	R8.5	17.0	13.5	4.2
XMB130A200	XMM110V200	XMB110D200	R10.0	20.0	16.0	5.2
XMB130A210	XMM110V210	XMB110D210	R10.5	21.0	16.5	5.2
XMB130A250	XMM110V250	XMB110D250	R12.5	25.0	19.5	6.2
XMB130A260	XMM110V260	XMB110D260	R13.0	26.0	20.0	6.2
XMB130A300	XMM110V300	XMB110D300	R15.0	30.0	23.5	7.2
XMB130A320	XMM110V320	XMB110D320	R16.0	32.0	24.5	7.2
XMB130A330	XMM110V330	XMB110D330	R16.5	33.0	25.0	7.2

▶ The ball radius tolerance is ±0.01mm and the set-up accuracy is ±0.02mm.

◎ : Excellent ○ : Good

ISO	P										M				K					
	Non-alloy steel					Low alloy steel					High alloyed steel, and tool steel	Stainless steel		Grey cast iron		Nodular cast iron		Malleable cast iron		
Material Description	1	2	3	4	5	6	7	8	9	10	11	12	13	14	15	16	17	18	19	20
VDI 3323	1	2	3	4	5	6	7	8	9	10	11	12	13	14	15	16	17	18	19	20
HRc	13	25	28	32	38	10	29	32	38	45	15	23	10	10	26	3	25	3	25	
HB	125	190	250	270	300	180	275	300	350	200	325	200	240	180	180	260	160	250	130	230
XMB130A											◎	◎	◎							
XMM110V	◎	◎	◎	◎		◎	◎				◎									
XMB110D																				

ISO	N						S					H									
	Aluminum-wrought alloy		Aluminum-cast, alloyed		Copper and Copper Alloys (Bronze / Brass)		Non Metallic Materials			Heat Resistant Super Alloys		Titanium Alloys		Hardened steel	Chilled Cast Iron	Hardened Cast Iron					
Material Description	21	22	23	24	25	26	27	28	29	30	31	32	33	34	35	36	37	38	39	40	41
VDI 3323	21	22	23	24	25	26	27	28	29	30	31	32	33	34	35	36	37	38	39	40	41
HRc	21	22	23	24	25	26	27	28	29	30	31	32	33	34	35	36	37	38	39	40	41
HB	60	100	75	90	130	110	90	100			200	280	250	350	320	400 Rm	1050 Rm	550	630	400	550
XMB130A																					
XMM110V																					
XMB110D	○	○	○	○																	



XMR110A SERIES
XMR120C SERIES
XMR260T SERIES

i-Xmill CORNER RADIUS INSERT

- i-Xmill WECHSELPLATTE mit GERADER STIRN UND ECKRADIUS
- i-Xmill - Plaquette pour usage général et inox
- INSERTI IN MD, TORICI

- ▶ The optimized geometry of the tool achieves better reliability and less vibration and cutting load.
- ▶ Interchangeable with i-Xmill ball holder, but precise cutting is possible with i-Xmill corner radius holder due to higher stability and strength of tool.
- ▶ The varied and wide cutting range makes it possible to machine from roughing through to finishing.
- ▶ Special coating makes high hardness with high thermal stability against oxidation.

- ▶ Die optimale Werkzeuggeometrie für große Betriebssicherheit und geringe Vibration und Schneidendruck.
- ▶ Einsetzbar wie i-Xmill Rundplattenhalter, aber eine größere Schnittgenauigkeit ist mit dem Vierkantplattenhalter möglich, wegen der größeren Steifigkeit und Stärke des Werkzeugs.
- ▶ Die große Einsatzbreite des Werkzeugs macht den Einsatz sowohl zum Schruppen als auch zum Schlichten möglich.
- ▶ Eine spezielle Beschichtung verleiht der Schneide große Härte und Hitzebeständigkeit.

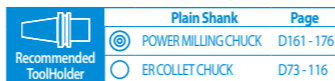
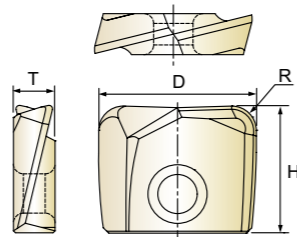

cutting conditions : p.C62

Unit : mm

EDP No.			Corner Radius	Mill Diameter	Height	Thickness
AITIN	X-Coating	Z-Coating				
For General Purpose & Stainless Steels	For Pre-Hardened Steels	For High Hardened Steels	R	D	H	T
XMR110A080 03	XMR120C080 03	XMR260T080 03	R0.3	8.0	8.0	2.4
XMR110A080 05	XMR120C080 05	XMR260T080 05	R0.5	8.0	8.0	2.4
XMR110A080 10	XMR120C080 10	XMR260T080 10	R1.0	8.0	8.0	2.4
XMR110A080 20	XMR120C080 20	XMR260T080 20	R2.0	8.0	8.0	2.4
XMR110A100 03	XMR120C100 03	XMR260T100 03	R0.3	10.0	9.5	2.7
XMR110A100 05	XMR120C100 05	XMR260T100 05	R0.5	10.0	9.5	2.7
XMR110A100 10	XMR120C100 10	XMR260T100 10	R1.0	10.0	9.5	2.7
XMR110A100 15	XMR120C100 15	XMR260T100 15	R1.5	10.0	9.5	2.7
XMR110A100 20	XMR120C100 20	XMR260T100 20	R2.0	10.0	9.5	2.7
XMR110A100 30	XMR120C100 30	XMR260T100 30	R3.0	10.0	9.5	2.7
XMR110A110 03	XMR120C110 03	XMR260T110 03	R0.3	11.0	9.5	2.7
XMR110A110 05	XMR120C110 05	XMR260T110 05	R0.5	11.0	9.5	2.7
XMR110A110 10	XMR120C110 10	XMR260T110 10	R1.0	11.0	9.5	2.7
XMR110A110 15	XMR120C110 15	XMR260T110 15	R1.5	11.0	9.5	2.7
XMR110A110 20	XMR120C110 20	XMR260T110 20	R2.0	11.0	9.5	2.7
XMR110A110 30	XMR120C110 30	XMR260T110 30	R3.0	11.0	9.5	2.7

▶ The corner radius tolerance is ±0.015mm and the set-up accuracy is ±0.02mm.

▶ NEXT PAGE

◎ : Excellent ○ : Good

ISO Material Description	P										M				K					
	Non-alloy steel					Low alloy steel					High alloyed steel, and tool steel	Stainless steel		Grey cast iron		Nodular cast iron		Malleable cast iron		
VDI 3323	1	2	3	4	5	6	7	8	9	10	11	12	13	14	15	16	17	18	19	20
HRc	13	25	28	32	38	10	29	32	38	10	15	23	10		10	26	3	25	10	21
HB	125	190	250	270	300	180	275	300	350	200	325	200	240	180	180	260	160	250	130	230
XMR110A	◎	◎	◎	◎	◎					◎	◎	◎	◎	◎	◎	◎	◎	◎	◎	◎
XMR120C										◎	○	◎								
XMR260T																				

ISO Material Description	N						S					H									
	Aluminum-wrought alloy		Aluminum-cast, alloyed		Copper and Copper Alloys (Bronze / Brass)		Non Metallic Materials		Heat Resistant Super Alloys			Titanium Alloys		Hardened steel	Chilled Cast Iron	Hardened Cast Iron					
VDI 3323	21	22	23	24	25	26	27	28	29	30	31	32	33	34	35	36	37	38	39	40	41
HRc											15	30	25	38	34			55	60	42	55
HB	60	100	75	90	130	110	90	100			200	280	250	350	320	400 Rm	1050 Rm	550	630	400	550
XMR110A																		◎	◎	◎	◎
XMR120C																					
XMR260T																					



XMR110A SERIES
XMR120C SERIES
XMR260T SERIES

i-Xmill CORNER RADIUS INSERT

- i-Xmill WECHSELPLATTE mit GERADER STIRN UND ECKRADIUS
- i-Xmill - Plaquette pour usage général et inox
- INSERTI IN MD, TORICI

- ▶ The optimum geometry of the tool to achieve better reliability and less vibration and cutting load.
- ▶ Interchangeable with i-Xmill ball holder, but precise cutting is possible with i-Xmill corner radius holder due to higher stability and strength of tool.
- ▶ The varied and wide cutting range makes it possible to machine from roughing through to finishing.
- ▶ Special coating makes high hardness with high thermal stability against oxidation.

- ▶ Die optimale Werkzeuggeometrie für große Betriebssicherheit und geringe Vibration und Schneidendruck.
- ▶ Einsetzbar wie i-Xmill Rundplattenhalter, aber eine größere Schnittgenauigkeit ist mit dem Vierkantplattenhalter möglich, wegen der größeren Steifigkeit und Stärke des Werkzeugs.
- ▶ Die große Einsatzbreite des Werkzeugs macht den Einsatz sowohl zum Schruppen als auch zum Schlichten möglich.
- ▶ Eine spezielle Beschichtung verleiht der Schneide große Härte und Hitzebeständigkeit.

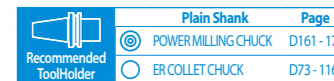
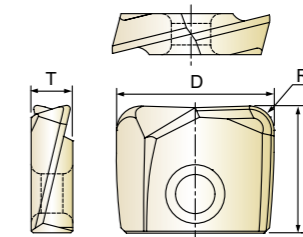

cutting conditions : p.C62

Unit : mm

EDP No.			Corner Radius	Mill Diameter	Height	Thickness
AITIN	X-Coating	Z-Coating				
For General Purpose & Stainless Steels	For Pre-Hardened Steels	For High Hardened Steels	R	D	H	T
XMR110A120 03	XMR120C120 03	XMR260T120 03	R0.3	12.0	11.0	3.2
XMR110A120 05	XMR120C120 05	XMR260T120 05	R0.5	12.0	11.0	3.2
XMR110A120 10	XMR120C120 10	XMR260T120 10	R1.0	12.0	11.0	3.2
XMR110A120 15	XMR120C120 15	XMR260T120 15	R1.5	12.0	11.0	3.2
XMR110A120 20	XMR120C120 20	XMR260T120 20	R2.0	12.0	11.0	3.2
XMR110A120 30	XMR120C120 30	XMR260T120 30	R3.0	12.0	11.0	3.2
XMR110A130 03	XMR120C130 03	XMR260T130 03	R0.3	13.0	11.2	3.2
XMR110A130 05	XMR120C130 05	XMR260T130 05	R0.5	13.0	11.2	3.2
XMR110A130 10	XMR120C130 10	XMR260T130 10	R1.0	13.0	11.2	3.2
XMR110A130 15	XMR120C130 15	XMR260T130 15	R1.5	13.0	11.2	3.2
XMR110A130 20	XMR120C130 20	XMR260T130 20	R2.0	13.0	11.2	3.2
XMR110A130 30	XMR120C130 30	XMR260T130 30	R3.0	13.0	11.2	3.2
XMR110A160 03	XMR120C160 03	XMR260T160 03	R0.3	16.0	13.0	4.2
XMR110A160 05	XMR120C160 05	XMR260T160 05	R0.5	16.0	13.0	4.2
XMR110A160 10	XMR120C160 10	XMR260T160 10	R1.0	16.0	13.0	4.2
XMR110A160 15	XMR120C160 15	XMR260T160 15	R1.5	16.0	13.0	4.2
XMR110A160 20	XMR120C160 20	XMR260T160 20	R2.0	16.0	13.0	4.2
XMR110A160 30	XMR120C160 30	XMR260T160 30	R3.0	16.0	13.0	4.2

▶ The corner radius tolerance is ±0.015mm and the set-up accuracy is ±0.02mm.

▶ NEXT PAGE

◎ : Excellent ○ : Good

ISO Material Description	P										M				K					
	Non-alloy steel					Low alloy steel					High alloyed steel, and tool steel	Stainless steel		Grey cast iron		Nodular cast iron		Malleable cast iron		
VDI 3323	1	2	3	4	5	6	7	8	9	10	11	12	13	14	15	16	17	18	19	20
HRc	13	25	28	32	38	10	29	32	38	15	35	15	23	10	10	26	3	25	10	21
HB	125	190	250	270	300	180	275	300	350	200	325	200	240	180	180	260	160	250	130	230
XMR110A	◎	◎	◎	◎	◎					◎	◎	◎	◎	◎	◎	◎	◎	◎	◎	◎
XMR120C										◎	◎	◎			◎	◎				
XMR260T																				

ISO Material Description	N						S					H									
	Aluminum-wrought alloy		Aluminum-cast, alloyed		Copper and Copper Alloys (Bronze / Brass)		Non Metallic Materials		Heat Resistant Super Alloys			Titanium Alloys		Hardened steel	Chilled Cast Iron	Hardened Cast Iron					
VDI 3323	21	22	23	24	25	26	27	28	29	30	31	32	33	34	35	36	37	38	39	40	41
HRc											15	30	25	38	34			55	60	42	55
HB	60	100	75	90	130	110	90	100			200	280	250	350	320	400 Rm	1050 Rm	550	630	400	550
XMR110A																		◎	◎	◎	◎
XMR120C																					
XMR260T																					

i-Xmill CORNER RADIUS INSERT

- i-Xmill WECHSELPLATTE mit GERADER STIRN UND ECKRADIUS
- i-Xmill - Plaquette pour usage général et inox
- INSERTI IN MD, TORICI

- ▶ The optimized geometry of the tool achieves better reliability and less vibration and cutting load.
- ▶ Interchangeable with i-Xmill ball holder, but precise cutting is possible with i-Xmill corner radius holder due to higher stability and strength of tool.
- ▶ The varied and wide cutting range makes it possible to machine from roughing through to finishing.
- ▶ Special coating makes high hardness with high thermal stability against oxidation.

- ▶ Die optimale Werkzeuggeometrie für große Betriebssicherheit und geringe Vibration und Schneidendruck.
- ▶ Einsetzbar wie i-Xmill Rundplattenhalter, aber eine größere Schnittgenauigkeit ist mit dem Vierkantplattenhalter möglich, wegen der größeren Steifigkeit und Stärke des Werkzeugs.
- ▶ Die große Einsatzbreite des Werkzeugs macht den Einsatz sowohl zum Schruppen als auch zum Schlichten möglich.
- ▶ Eine spezielle Beschichtung verleiht der Schneide große Härte und Hitzebeständigkeit.

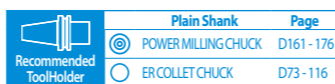
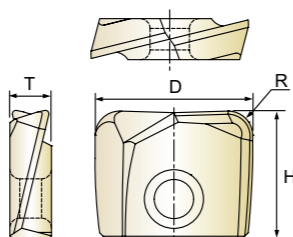

cutting conditions : p.C62

Unit : mm

EDP No.			Corner Radius	Mill Diameter	Height	Thickness
AITIN	X-Coating	Z-Coating				
For General Purpose & Stainless Steels	For Pre-Hardened Steels	For High Hardened Steels	R	D	H	T
XMR110A170 03	XMR120C170 03	XMR260T170 03	R0.3	17.0	13.0	4.2
XMR110A170 05	XMR120C170 05	XMR260T170 05	R0.5	17.0	13.0	4.2
XMR110A170 10	XMR120C170 10	XMR260T170 10	R1.0	17.0	13.0	4.2
XMR110A170 15	XMR120C170 15	XMR260T170 15	R1.5	17.0	13.0	4.2
XMR110A170 20	XMR120C170 20	XMR260T170 20	R2.0	17.0	13.0	4.2
XMR110A170 30	XMR120C170 30	XMR260T170 30	R3.0	17.0	13.0	4.2
XMR110A200 03	XMR120C200 03	XMR260T200 03	R0.3	20.0	16.0	5.2
XMR110A200 05	XMR120C200 05	XMR260T200 05	R0.5	20.0	16.0	5.2
XMR110A200 10	XMR120C200 10	XMR260T200 10	R1.0	20.0	16.0	5.2
XMR110A200 15	XMR120C200 15	XMR260T200 15	R1.5	20.0	16.0	5.2
XMR110A200 20	XMR120C200 20	XMR260T200 20	R2.0	20.0	16.0	5.2
XMR110A200 30	XMR120C200 30	XMR260T200 30	R3.0	20.0	16.0	5.2
XMR110A210 03	XMR120C210 03	XMR260T210 03	R0.3	21.0	16.0	5.2
XMR110A210 05	XMR120C210 05	XMR260T210 05	R0.5	21.0	16.0	5.2
XMR110A210 10	XMR120C210 10	XMR260T210 10	R1.0	21.0	16.0	5.2
XMR110A210 15	XMR120C210 15	XMR260T210 15	R1.5	21.0	16.0	5.2
XMR110A210 20	XMR120C210 20	XMR260T210 20	R2.0	21.0	16.0	5.2
XMR110A210 30	XMR120C210 30	XMR260T210 30	R3.0	21.0	16.0	5.2

▶ The corner radius tolerance is ±0.015mm and the set-up accuracy is ±0.02mm. ▶ NEXT PAGE

◎ : Excellent ○ : Good

ISO Material Description	P										M				K					
	Non-alloy steel					Low alloy steel					High alloyed steel, and tool steel	Stainless steel		Grey cast iron		Nodular cast iron		Malleable cast iron		
VDI 3323	1	2	3	4	5	6	7	8	9	10	11	12	13	14	15	16	17	18	19	20
HRc	13	25	28	32	38	10	29	32	38	10	15	23	10	10	26	3	25	10	21	
HB	125	190	250	270	300	180	275	300	350	200	325	200	240	180	180	260	160	250	130	230
XMR110A	◎	◎	◎	◎	◎	◎	◎	◎	◎	◎	◎	◎	◎	◎	◎	◎	◎	◎	◎	◎
XMR120C										◎	◎									
XMR260T																				

ISO Material Description	N										S					H					
	Aluminum-wrought alloy		Aluminum-cast, alloyed			Copper and Copper Alloys (Bronze / Brass)		Non Metallic Materials			Heat Resistant Super Alloys					Titanium Alloys		Hardened steel	Chilled Cast Iron	Hardened Cast Iron	
VDI 3323	21	22	23	24	25	26	27	28	29	30	31	32	33	34	35	36	37	38	39	40	41
HRc	21	22	23	24	25	26	27	28	29	30	31	32	33	34	35	36	37	55	60	42	55
HB	60	100	75	90	130	110	90	100			200	280	250	350	320	400 Rm	1050 Rm	550	630	400	550
XMR110A																		◎	◎	◎	◎
XMR120C																					
XMR260T																					

i-Xmill CORNER RADIUS INSERT

- i-Xmill WECHSELPLATTE mit GERADER STIRN UND ECKRADIUS
- i-Xmill - Plaquette pour usage général et inox
- INSERTI IN MD, TORICI

- ▶ The optimized geometry of the tool achieves better reliability and less vibration and cutting load.
- ▶ Interchangeable with i-Xmill ball holder, but precise cutting is possible with i-Xmill corner radius holder due to higher stability and strength of tool.
- ▶ The varied and wide cutting range makes it possible to machine from roughing through to finishing.
- ▶ Special coating makes high hardness with high thermal stability against oxidation.

- ▶ Die optimale Werkzeuggeometrie für große Betriebssicherheit und geringe Vibration und Schneidendruck.
- ▶ Einsetzbar wie i-Xmill Rundplattenhalter, aber eine größere Schnittgenauigkeit ist mit dem Vierkantplattenhalter möglich, wegen der größeren Steifigkeit und Stärke des Werkzeugs.
- ▶ Die große Einsatzbreite des Werkzeugs macht den Einsatz sowohl zum Schruppen als auch zum Schlichten möglich.
- ▶ Eine spezielle Beschichtung verleiht der Schneide große Härte und Hitzebeständigkeit.

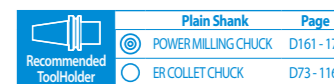
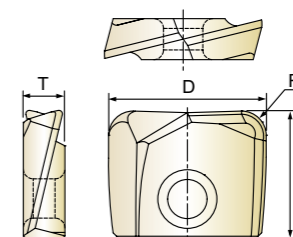

cutting conditions : p.C62

Unit : mm

EDP No.			Corner Radius	Mill Diameter	Height	Thickness
AITIN	X-Coating	Z-Coating				
For General Purpose & Stainless Steels	For Pre-Hardened Steels	For High Hardened Steels	R	D	H	T
XMR110A250 03	XMR120C250 03	XMR260T250 03	R0.3	25.0	19.5	6.2
XMR110A250 05	XMR120C250 05	XMR260T250 05	R0.5	25.0	19.5	6.2
XMR110A250 10	XMR120C250 10	XMR260T250 10	R1.0	25.0	19.5	6.2
XMR110A250 15	XMR120C250 15	XMR260T250 15	R1.5	25.0	19.5	6.2
XMR110A250 20	XMR120C250 20	XMR260T250 20	R2.0	25.0	19.5	6.2
XMR110A250 30	XMR120C250 30	XMR260T250 30	R3.0	25.0	19.5	6.2
XMR110A260 03	XMR120C260 03	XMR260T260 03	R0.3	26.0	19.5	6.2
XMR110A260 05	XMR120C260 05	XMR260T260 05	R0.5	26.0	19.5	6.2
XMR110A260 10	XMR120C260 10	XMR260T260 10	R1.0	26.0	19.5	6.2
XMR110A260 15	XMR120C260 15	XMR260T260 15	R1.5	26.0	19.5	6.2
XMR110A260 20	XMR120C260 20	XMR260T260 20	R2.0	26.0	19.5	6.2
XMR110A260 30	XMR120C260 30	XMR260T260 30	R3.0	26.0	19.5	6.2
XMR110A300 03	XMR120C300 03	XMR260T300 03	R0.3	30.0	23.5	7.2
XMR110A300 05	XMR120C300 05	XMR260T300 05	R0.5	30.0	23.5	7.2
XMR110A300 10	XMR120C300 10	XMR260T300 10	R1.0	30.0	23.5	7.2
XMR110A300 15	XMR120C300 15	XMR260T300 15	R1.5	30.0	23.5	7.2
XMR110A300 20	XMR120C300 20	XMR260T300 20	R2.0	30.0	23.5	7.2
XMR110A300 30	XMR120C300 30	XMR260T300 30	R3.0	30.0	23.5	7.2

▶ The corner radius tolerance is ±0.015mm and the set-up accuracy is ±0.02mm. ▶ NEXT PAGE

◎ : Excellent ○ : Good

ISO Material Description	P										M				K					
	Non-alloy steel					Low alloy steel					High alloyed steel, and tool steel	Stainless steel		Grey cast iron		Nodular cast iron		Malleable cast iron		
VDI 3323	1	2	3	4	5	6	7	8	9	10	11	12	13	14	15	16	17	18	19	20
HRc	13	25	28	32	38	10	29	32	38	10	15	23	10	10	26	3	25	10	21	
HB	125	190	250	270	300	180	275	300	350	200	325	200	240	180	180	260	160	250	130	230
XMR110A	◎	◎	◎	◎	◎	◎	◎	◎	◎	◎	◎	◎	◎	◎	◎	◎	◎	◎	◎	◎
XMR120C										◎	◎									
XMR260T																				

ISO Material Description	N										S					H					
	Aluminum-wrought alloy		Aluminum-cast, alloyed			Copper and Copper Alloys (Bronze / Brass)		Non Metallic Materials			Heat Resistant Super Alloys					Titanium Alloys		Hardened steel	Chilled Cast Iron	Hardened Cast Iron	
VDI 3323	21	22	23	24	25	26	27	28	29	30	31	32	33	34	35	36	37	38	39	40	41
HRc	21	22	23	24	25	26	27	28	29	30	31	32	33	34	35	36	37	55	60	42	55
HB	60	100	75	90	130	110	90	100			200	280	250	350	320	400 Rm	1050 Rm	550	630	400	550
XMR110A																		◎	◎	◎	◎
XMR120C																					
XMR260T																					



XMR110A SERIES
XMR120C SERIES
XMR260T SERIES

i-Xmill CORNER RADIUS INSERT

- i-Xmill WECHSELPLATTE mit GERADER STIRN UND ECKRADIUS
- i-Xmill - Plaquette pour usage général et inox
- INSERTI IN MD, TORICI

- ▶ The optimized geometry of the tool achieves better reliability and less vibration and cutting load.
- ▶ Interchangeable with i-Xmill ball holder, but precise cutting is possible with i-Xmill corner radius holder due to higher stability and strength of tool.
- ▶ The varied and wide cutting range makes it possible to machine from roughing through to finishing.
- ▶ Special coating makes high hardness with high thermal stability against oxidation.

- ▶ Die optimale Werkzeuggeometrie für große Betriebssicherheit und geringe Vibration und Schneidendruck.
- ▶ Einsetzbar wie i-Xmill Rundplattenhalter, aber eine größere Schnittgenauigkeit ist mit dem Vierkantplattenhalter möglich, wegen der größeren Steifigkeit und Stärke des Werkzeugs.
- ▶ Die große Einsatzbreite des Werkzeugs macht den Einsatz sowohl zum Schruppen als auch zum Schlichten möglich.
- ▶ Eine spezielle Beschichtung verleiht der Schneide große Härte und Hitzebeständigkeit.

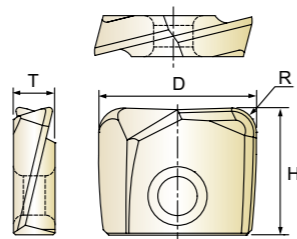

Recommended ToolHolder	Plain Shank	Page
○	POWER MILLING CHUCK	D161 - 176
○	ER COLLET CHUCK	D73 - 116

cutting conditions : p.C62

Unit : mm

EDP No.			Corner Radius	Mill Diameter	Height	Thickness
AITIN	X-Coating	Z-Coating				
For General Purpose & Stainless Steels	For Pre-Hardened Steels	For High Hardened Steels	R	D	H	T
XMR110A320 03	XMR120C320 03	XMR260T320 03	R0.3	32.0	23.5	7.2
XMR110A320 05	XMR120C320 05	XMR260T320 05	R0.5	32.0	23.5	7.2
XMR110A320 10	XMR120C320 10	XMR260T320 10	R1.0	32.0	23.5	7.2
XMR110A320 15	XMR120C320 15	XMR260T320 15	R1.5	32.0	23.5	7.2
XMR110A320 20	XMR120C320 20	XMR260T320 20	R2.0	32.0	23.5	7.2
XMR110A320 30	XMR120C320 30	XMR260T320 30	R3.0	32.0	23.5	7.2
XMR110A330 03	XMR120C330 03	XMR260T330 03	R0.3	33.0	23.5	7.2
XMR110A330 05	XMR120C330 05	XMR260T330 05	R0.5	33.0	23.5	7.2
XMR110A330 10	XMR120C330 10	XMR260T330 10	R1.0	33.0	23.5	7.2
XMR110A330 15	XMR120C330 15	XMR260T330 15	R1.5	33.0	23.5	7.2
XMR110A330 20	XMR120C330 20	XMR260T330 20	R2.0	33.0	23.5	7.2
XMR110A330 30	XMR120C330 30	XMR260T330 30	R3.0	33.0	23.5	7.2

▶ The corner radius tolerance is ±0.015mm and the set-up accuracy is ±0.02mm.

◎ : Excellent ○ : Good

ISO Material Description	P											M				K				
	Non-alloy steel					Low alloy steel						High alloyed steel, and tool steel		Stainless steel		Grey cast iron		Nodular cast iron		Malleable cast iron
VDI 3323	1	2	3	4	5	6	7	8	9	10	11	12	13	14	15	16	17	18	19	20
HRc	13	25	28	32	38	42	48	52	58	62	68	72	78	82	10	26	3	25	21	21
HB	125	190	250	270	300	180	275	300	350	200	325	200	240	180	180	260	160	250	130	230
XMR110A	◎	◎	◎	◎	◎	◎	◎	◎	◎	◎	◎	◎	◎	◎	◎	◎	◎	◎	◎	◎
XMR120C										◎	○	◎			◎	◎	◎	◎	◎	◎
XMR260T																				

ISO Material Description	N										S					H					
	Aluminum-wrought alloy		Aluminum-cast, alloyed			Copper and Copper Alloys (Bronze / Brass)			Non Metallic Materials		Heat Resistant Super Alloys					Titanium Alloys		Hardened steel	Chilled Cast Iron	Hardened Cast Iron	
VDI 3323	21	22	23	24	25	26	27	28	29	30	31	32	33	34	35	36	37	38	39	40	41
HRc	15	30	25	38	34	15	30	25	38	34	15	30	25	38	34	400 Rm	1050 Rm	55	60	42	55
HB	60	100	75	90	130	110	90	100			200	280	250	350	320	400 Rm	1050 Rm	550	630	400	550
XMR110A																					
XMR120C																		○	◎	○	◎
XMR260T																		◎	◎	○	◎



XMF110V SERIES
XMR110D SERIES

i-Xmill CORNER RADIUS INSERT

- i-Xmill WECHSELPLATTE mit GERADER STIRN UND ECKRADIUS
- i-Xmill Plaquette Torique AVEC RAYON de coupe frontale
- INSERTI IN MD, TORICI & TORICI HIGH FEED

- ▶ The optimized geometry of the tool achieves better reliability and less vibration and cutting load.
- ▶ Interchangeable with i-Xmill ball holder, but precise cutting is possible with i-Xmill corner radius holder due to higher stability and strength of tool.
- ▶ The varied and wide cutting range makes it possible to machine from roughing through to finishing.
- ▶ Special coating makes high hardness with high thermal stability against oxidation.

- ▶ Die optimale Werkzeuggeometrie für große Betriebssicherheit und geringe Vibration und Schneidendruck.
- ▶ Einsetzbar wie i-Xmill Rundplattenhalter, aber eine größere Schnittgenauigkeit ist mit dem Vierkantplattenhalter möglich, wegen der größeren Steifigkeit und Stärke des Werkzeugs.
- ▶ Die große Einsatzbreite des Werkzeugs macht den Einsatz sowohl zum Schruppen als auch zum Schlichten möglich.
- ▶ Eine spezielle Beschichtung verleiht der Schneide große Härte und Hitzebeständigkeit.

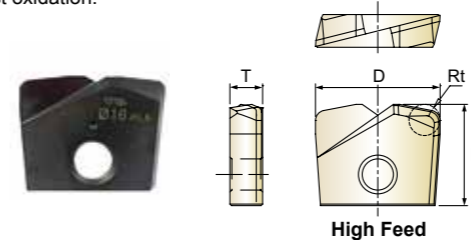

Recommended ToolHolder	Plain Shank	Page
◎	POWER MILLING CHUCK	D161 - 176
○	ER COLLET CHUCK	D73 - 116

cutting conditions : p.C63

Unit : mm

EDP No.		Corner Radius	Mill Diameter	Height	Thickness	for High Feed
Y-Coating	Diamond					
For General Purpose High Feed	For Graphite	R (Rt)	D	H	T	apMax.
-	XMR110D080 03	R0.3	8.0	8.0	2.4	0.4
-	XMR110D080 05	R0.5	8.0	8.0	2.4	0.4
XMF110V080 08	-	R0.8	8.0	8.0	2.4	0.4
-	XMR110D080 10	R1.0	8.0	8.0	2.4	0.4
-	XMR110D080 20	R2.0	8.0	8.0	2.4	0.4
-	XMR110D100 03	R0.3	10.0	9.5	2.7	0.5
-	XMR110D100 05	R0.5	10.0	9.5	2.7	0.5
XMF110V100 10	XMR110D100 10	R1.0	10.0	9.5	2.7	0.5
-	XMR110D100 15	R1.5	10.0	9.5	2.7	0.5
-	XMR110D100 20	R2.0	10.0	9.5	2.7	0.5
-	XMR110D100 30	R3.0	10.0	9.5	2.7	0.5
-	XMR110D110 03	R0.3	11.0	9.5	2.7	0.5
-	XMR110D110 05	R0.5	11.0	9.5	2.7	0.5
XMF110V110 10	XMR110D110 10	R1.0	11.0	9.5	2.7	0.5
-	XMR110D110 15	R1.5	11.0	9.5	2.7	0.5
-	XMR110D110 20	R2.0	11.0	9.5	2.7	0.5
-	XMR110D110 30	R3.0	11.0	9.5	2.7	0.5

▶ The corner radius tolerance is ±0.015mm(Rt tolerance is ±0.05mm) and the set-up accuracy is ±0.02mm.

▶ NEXT PAGE

◎ : Excellent ○ : Good

ISO Material Description	P											M				K				
	Non-alloy steel					Low alloy steel						High alloyed steel, and tool steel		Stainless steel		Grey cast iron		Nodular cast iron		Malleable cast iron
VDI 3323	1	2	3	4	5	6	7	8	9	10	11	12	13	14	15	16	17	18	19	20
HRc	13	25	28	32	38	42	48	52	58	62	68	72	78	82	10	26	3	25	21	21
HB	125	190	250	270	300	180	275	300	350	200	325	200	240	180	180	260	160	250	130	230
XMF110V	◎	◎	◎	◎	◎	◎	◎	◎	◎	◎	◎									
XMR110D																				

ISO Material Description	N										S					H					
	Aluminum-wrought alloy		Aluminum-cast, alloyed			Copper and Copper Alloys (Bronze / Brass)			Non Metallic Materials		Heat Resistant Super Alloys					Titanium Alloys		Hardened steel	Chilled Cast Iron	Hardened Cast Iron	
VDI 3323	21	22	23	24	25	26	27	28	29	30	31	32	33	34	35	36	37	38	39	40	41
HRc	15	30	25	38	34	15	30	25	38	34	15	30	25	38	34	400 Rm	1050 Rm	55	60	42	55
HB	60	100	75	90	130	110	90	100			200	280	250	350	320	400 Rm	1050 Rm	550	630	400	550
XMF110V																					
XMR110D	○	○	○	○														◎	◎	○	◎

i-Xmill CORNER RADIUS INSERT

- i-Xmill WECHSELPLATTE mit GERADER STIRN UND ECKRADIUS
- i-Xmill Plaquette Torique AVEC RAYON de coupe frontale
- INSERTI IN MD, TORICI & TORICI HIGH FEED

- ▶ The optimized geometry of the tool achieves better reliability and less vibration and cutting load.
- ▶ Interchangeable with i-Xmill ball holder, but precise cutting is possible with i-Xmill corner radius holder due to higher stability and strength of tool.
- ▶ The varied and wide cutting range makes it possible to machine from roughing through to finishing.
- ▶ Special coating makes high hardness with high thermal stability against oxidation.

- ▶ Die optimale Werkzeuggeometrie für große Betriebssicherheit und geringe Vibration und Schneidendruck.
- ▶ Einsetzbar wie i-Xmill Rundplattenhalter, aber eine größere Schnittgenauigkeit ist mit dem Vierkantplattenhalter möglich, wegen der größeren Steifigkeit und Stärke des Werkzeugs.
- ▶ Die große Einsatzbreite des Werkzeugs macht den Einsatz sowohl zum Schruppen als auch zum Schlichten möglich.
- ▶ Eine spezielle Beschichtung verleiht der Schneide große Härte und Hitzebeständigkeit.

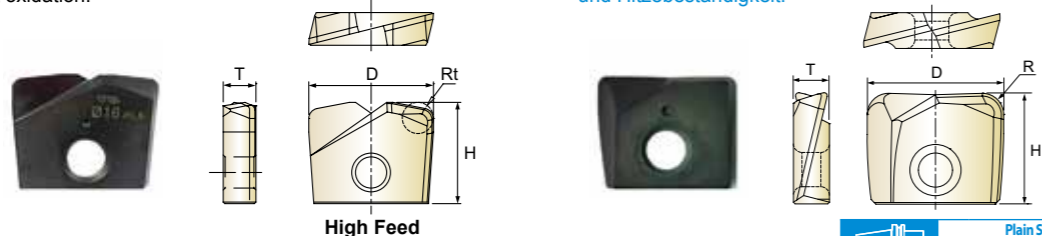

cutting conditions : p.C63

Plain Shank	Page
POWER MILLING CHUCK	D161 - 176
ER COLLET CHUCK	D73 - 116

EDP No.		Corner Radius	Mill Diameter	Height	Thickness	for High Feed
Y-Coating	Diamond					
For General Purpose High Feed	For Graphite	R (Rt)	D	H	T	apMax.
-	XMR110D120 03	R0.3	12.0	11.0	2.7	0.6
-	XMR110D120 05	R0.5	12.0	11.0	2.7	0.6
XMF110V120 10	XMR110D120 10	R1.0	12.0	11.0	2.7	0.6
-	XMR110D120 15	R1.5	12.0	11.0	2.7	0.6
-	XMR110D120 20	R2.0	12.0	11.0	2.7	0.6
-	XMR110D120 30	R3.0	12.0	11.0	2.7	0.6
-	XMR110D130 03	R0.3	13.0	11.2	2.7	0.6
-	XMR110D130 05	R0.5	13.0	11.2	2.7	0.6
XMF110V130 10	XMR110D130 10	R1.0	13.0	11.2	2.7	0.6
-	XMR110D130 15	R1.5	13.0	11.2	2.7	0.6
-	XMR110D130 20	R2.0	13.0	11.2	2.7	0.6
-	XMR110D130 30	R3.0	13.0	11.2	2.7	0.6
-	XMR110D160 03	R0.3	16.0	13.0	4.2	0.8
-	XMR110D160 05	R0.5	16.0	13.0	4.2	0.8
-	XMR110D160 10	R1.0	16.0	13.0	4.2	0.8
XMF110V160 15	XMR110D160 15	R1.5	16.0	13.0	4.2	0.8
-	XMR110D160 20	R2.0	16.0	13.0	4.2	0.8
-	XMR110D160 30	R3.0	16.0	13.0	4.2	0.8

▶ The corner radius tolerance is ±0.015mm(Rt tolerance is ±0.05mm) and the set-up accuracy is ±0.02mm. ▶ NEXT PAGE

ISO	P										M				K					
	Non-alloy steel					Low alloy steel					High alloyed steel, and tool steel				Stainless steel		Grey cast iron		Nodular cast iron	
Material Description	1	2	3	4	5	6	7	8	9	10	11	12	13	14	15	16	17	18	19	20
VDI 3323	1	2	3	4	5	6	7	8	9	10	11	12	13	14	15	16	17	18	19	20
HRc	13	25	28	32	38	42	48	52	58	62	68	72	78	82	10	26	3	25	21	
HB	125	190	250	270	300	180	275	300	350	200	325	200	240	180	180	260	160	250	130	230
XMF110V	◎	◎	◎	◎	◎	◎	◎	◎	◎	◎	◎									
XMR110D																				

i-Xmill CORNER RADIUS INSERT

- i-Xmill WENDEPLATTE mit GERADER STIRN UND ECKRADIUS
- i-Xmill Plaquette Torique AVEC RAYON de coupe frontale
- INSERTI IN MD, TORICI & TORICI HIGH FEED

- ▶ The optimized geometry of the tool achieves better reliability and less vibration and cutting load.
- ▶ Interchangeable with i-Xmill ball holder, but precise cutting is possible with i-Xmill corner radius holder due to higher stability and strength of tool.
- ▶ The varied and wide cutting range makes it possible to machine from roughing through to finishing.
- ▶ Special coating makes high hardness with high thermal stability against oxidation.

- ▶ Die optimale Werkzeuggeometrie für große Betriebssicherheit und geringe Vibration und Schneidendruck.
- ▶ Einsetzbar wie i-Xmill Rundplattenhalter, aber eine größere Schnittgenauigkeit ist mit dem Vierkantplattenhalter möglich, wegen der größeren Steifigkeit und Stärke des Werkzeugs.
- ▶ Die große Einsatzbreite des Werkzeugs macht den Einsatz sowohl zum Schruppen als auch zum Schlichten möglich.
- ▶ Eine spezielle Beschichtung verleiht der Schneide große Härte und Hitzebeständigkeit.

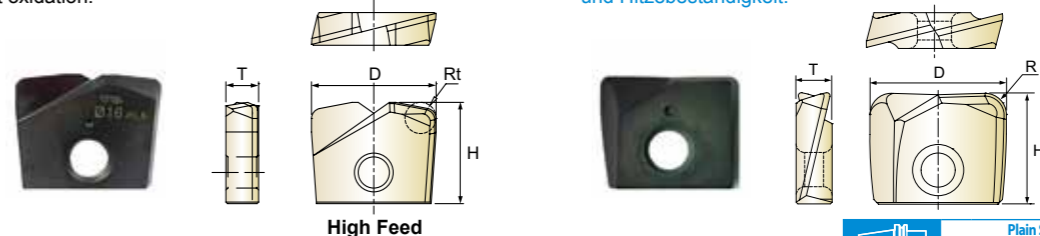

cutting conditions : p.C63

Plain Shank	Page
POWER MILLING CHUCK	D161 - 176
ER COLLET CHUCK	D73 - 116

EDP No.		Corner Radius	Mill Diameter	Height	Thickness	for High Feed
Y-Coating	Diamond					
For General Purpose High Feed	For Graphite	R (Rt)	D	H	T	apMax.
-	XMR110D170 03	R0.3	17.0	13.0	4.2	0.8
-	XMR110D170 05	R0.5	17.0	13.0	4.2	0.8
-	XMR110D170 10	R1.0	17.0	13.0	4.2	0.8
XMF110V170 15	XMR110D170 15	R1.5	17.0	13.0	4.2	0.8
-	XMR110D170 20	R2.0	17.0	13.0	4.2	0.8
-	XMR110D170 30	R3.0	17.0	13.0	4.2	0.8
-	XMR110D200 03	R0.3	20.0	16.0	5.2	1.0
-	XMR110D200 05	R0.5	20.0	16.0	5.2	1.0
-	XMR110D200 10	R1.0	20.0	16.0	5.2	1.0
-	XMR110D200 15	R1.5	20.0	16.0	5.2	1.0
XMF110V200 20	XMR110D200 20	R2.0	20.0	16.0	5.2	1.0
-	XMR110D200 30	R3.0	20.0	16.0	5.2	1.0
-	XMR110D210 03	R0.3	21.0	16.0	5.2	1.0
-	XMR110D210 05	R0.5	21.0	16.0	5.2	1.0
-	XMR110D210 10	R1.0	21.0	16.0	5.2	1.0
-	XMR110D210 15	R1.5	21.0	16.0	5.2	1.0
XMF110V210 20	XMR110D210 20	R2.0	21.0	16.0	5.2	1.0
-	XMR110D210 30	R3.0	21.0	16.0	5.2	1.0

▶ The corner radius tolerance is ±0.015mm(Rt tolerance is ±0.05mm) and the set-up accuracy is ±0.02mm. ▶ NEXT PAGE

ISO	P										M				K					
	Non-alloy steel					Low alloy steel					High alloyed steel, and tool steel				Stainless steel		Grey cast iron		Nodular cast iron	
Material Description	1	2	3	4	5	6	7	8	9	10	11	12	13	14	15	16	17	18	19	20
VDI 3323	1	2	3	4	5	6	7	8	9	10	11	12	13	14	15	16	17	18	19	20
HRc	13	25	28	32	38	42	48	52	58	62	68	72	78	82	10	26	3	25	21	
HB	125	190	250	270	300	180	275	300	350	200	325	200	240	180	180	260	160	250	130	230
XMF110V	◎	◎	◎	◎	◎	◎	◎	◎	◎	◎	◎									
XMR110D																				

i-Xmill CORNER RADIUS INSERT

- i-Xmill WENDEPLATTE mit GERADER STIRN UND ECKRADIUS
- i-Xmill Plaquette Torique AVEC RAYON de coupe frontale
- INSERTI IN MD, TORICI & TORICI HIGH FEED

- ▶ The optimized geometry of the tool achieves better reliability and less vibration and cutting load.
- ▶ Interchangeable with i-Xmill ball holder, but precise cutting is possible with i-Xmill corner radius holder due to higher stability and strength of tool.
- ▶ The varied and wide cutting range makes it possible to machine from roughing through to finishing.
- ▶ Special coating makes high hardness with high thermal stability against oxidation.

- ▶ Die optimale Werkzeuggeometrie für große Betriebssicherheit und geringe Vibration und Schneidendruck.
- ▶ Einsetzbar wie i-Xmill Rundplattenhalter, aber eine größere Schnittgenauigkeit ist mit dem Vierkantplattenhalter möglich, wegen der größeren Steifigkeit und Stärke des Werkzeugs.
- ▶ Die große Einsatzbreite des Werkzeugs macht den Einsatz sowohl zum Schruppen als auch zum Schlichten möglich.
- ▶ Eine spezielle Beschichtung verleiht der Schneide große Härte und Hitzebeständigkeit.

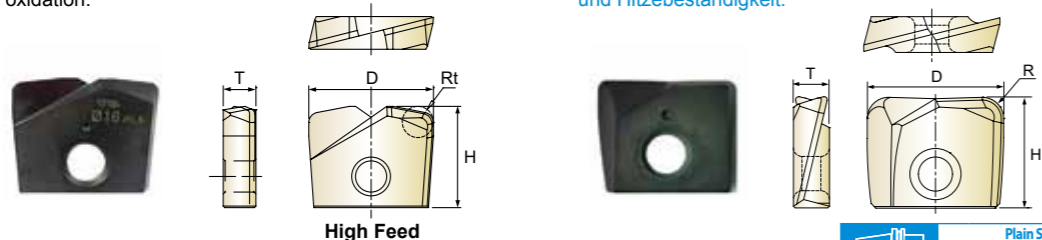

cutting conditions : p.C63

Plain Shank Page
Recommended ToolHolder POWER MILLING CHUCK D161 - 176
ER COLLET CHUCK D73 - 116

Unit : mm

EDP No.		Corner Radius	Mill Diameter	Height	Thickness	for High Feed
Y-Coating	Diamond					
For General Purpose High Feed	For Graphite	R (Rt)	D	H	T	apMax.
-	XMR110D250 03	R0.3	25.0	19.5	6.2	1.25
-	XMR110D250 05	R0.5	25.0	19.5	6.2	1.25
-	XMR110D250 10	R1.0	25.0	19.5	6.2	1.25
-	XMR110D250 15	R1.5	25.0	19.5	6.2	1.25
-	XMR110D250 20	R2.0	25.0	19.5	6.2	1.25
XMF110V250 25	-	R2.5	25.0	19.5	6.2	1.25
-	XMR110D250 30	R3.0	25.0	19.5	6.2	1.25
-	XMR110D260 03	R0.3	26.0	19.5	6.2	1.25
-	XMR110D260 05	R0.5	26.0	19.5	6.2	1.25
-	XMR110D260 10	R1.0	26.0	19.5	6.2	1.25
-	XMR110D260 15	R1.5	26.0	19.5	6.2	1.25
-	XMR110D260 20	R2.0	26.0	19.5	6.2	1.25
XMF110V260 25	-	R2.5	26.0	19.5	6.2	1.25
-	XMR110D260 30	R3.0	26.0	19.5	6.2	1.25
-	XMR110D300 03	R0.3	30.0	23.5	7.2	1.6
-	XMR110D300 05	R0.5	30.0	23.5	7.2	1.6
-	XMR110D300 10	R1.0	30.0	23.5	7.2	1.6
-	XMR110D300 15	R1.5	30.0	23.5	7.2	1.6
-	XMR110D300 20	R2.0	30.0	23.5	7.2	1.6
XMF110V300 30	XMR110D300 30	R3.0	30.0	23.5	7.2	1.6

▶ The corner radius tolerance is ±0.015mm(Rt tolerance is ±0.05mm) and the set-up accuracy is ±0.02mm.

▶ NEXT PAGE

◎ : Excellent ○ : Good

ISO Material Description	P									M				K						
	Non-alloy steel			Low alloy steel			High alloyed steel, and tool steel			Stainless steel		Grey cast iron		Nodular cast iron	Malleable cast iron					
VDI 3323	1	2	3	4	5	6	7	8	9	10	11	12	13	14	15	16	17	18	19	20
HRc	13	25	28	32	30	10	29	32	38	15	35	15	23	10	10	26	3	25	21	
HB	125	190	250	270	300	180	275	300	350	200	325	200	240	180	180	260	160	250	130	230
XMF110V	◎	◎	◎	◎	◎	◎	◎			◎										
XMR110D																				

ISO Material Description	N						S						H								
	Aluminum-wrought alloy		Aluminum-cast, alloyed		Copper and Copper Alloys (Bronze / Brass)		Non Metallic Materials			Heat Resistant Super Alloys			Titanium Alloys		Hardened steel	Chilled Cast Iron	Hardened Cast Iron				
VDI 3323	21	22	23	24	25	26	27	28	29	30	31	32	33	34	35	36	37	38	39	40	41
HRc											15	30	25	38	34	55	60	42	42	55	
HB	60	100	75	90	130	110	90	100			200	280	250	350	320	400 Rm	1050 Rm	550	630	400	550
XMF110V																					
XMR110D	○	○	○	○					◎												

i-Xmill CORNER RADIUS INSERT

- i-Xmill WENDEPLATTE mit GERADER STIRN UND ECKRADIUS
- i-Xmill Plaquette Torique AVEC RAYON de coupe frontale
- INSERTI IN MD, TORICI & TORICI HIGH FEED

- ▶ The optimized geometry of the tool achieves better reliability and less vibration and cutting load.
- ▶ Interchangeable with i-Xmill ball holder, but precise cutting is possible with i-Xmill corner radius holder due to higher stability and strength of tool.
- ▶ The varied and wide cutting range makes it possible to machine from roughing through to finishing.
- ▶ Special coating makes high hardness with high thermal stability against oxidation.

- ▶ Die optimale Werkzeuggeometrie für große Betriebssicherheit und geringe Vibration und Schneidendruck.
- ▶ Einsetzbar wie i-Xmill Rundplattenhalter, aber eine größere Schnittgenauigkeit ist mit dem Vierkantplattenhalter möglich, wegen der größeren Steifigkeit und Stärke des Werkzeugs.
- ▶ Die große Einsatzbreite des Werkzeugs macht den Einsatz sowohl zum Schruppen als auch zum Schlichten möglich.
- ▶ Eine spezielle Beschichtung verleiht der Schneide große Härte und Hitzebeständigkeit.

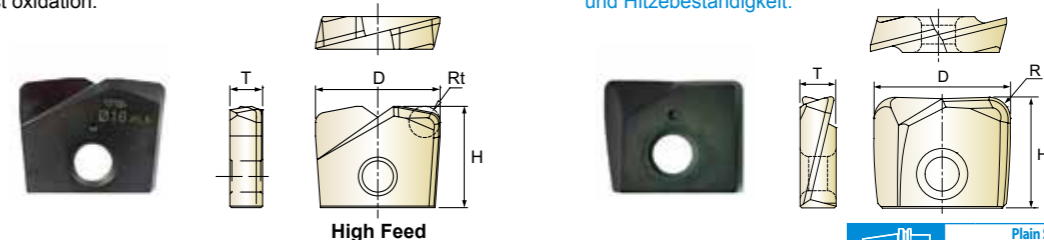

cutting conditions : p.C63

Plain Shank Page
Recommended ToolHolder POWER MILLING CHUCK D161 - 176
ER COLLET CHUCK D73 - 116

Unit : mm

EDP No.		Corner Radius	Mill Diameter	Height	Thickness	for High Feed
Y-Coating	Diamond					
For General Purpose High Feed	For Graphite	R (Rt)	D	H	T	apMax.
-	XMR110D320 03	R0.3	32.0	23.5	7.2	1.6
-	XMR110D320 05	R0.5	32.0	23.5	7.2	1.6
-	XMR110D320 10	R1.0	32.0	23.5	7.2	1.6
-	XMR110D320 15	R1.5	32.0	23.5	7.2	1.6
-	XMR110D320 20	R2.0	32.0	23.5	7.2	1.6
-	XMR110D320 30	R3.0	32.0	23.5	7.2	1.6
XMF110V320 32	XMR110D320 32	R3.2	32.0	23.5	7.2	1.6
-	XMR110D330 03	R0.3	33.0	23.5	7.2	1.6
-	XMR110D330 05	R0.5	33.0	23.5	7.2	1.6
-	XMR110D330 10	R1.0	33.0	23.5	7.2	1.6
-	XMR110D330 15	R1.5	33.0	23.5	7.2	1.6
-	XMR110D330 20	R2.0	33.0	23.5	7.2	1.6
-	XMR110D330 30	R3.0	33.0	23.5	7.2	1.6
XMF110V330 32	XMR110D330 32	R3.2	33.0	23.5	7.2	1.6

▶ The corner radius tolerance is ±0.015mm(Rt tolerance is ±0.05mm) and the set-up accuracy is ±0.02mm.

◎ : Excellent ○ : Good

ISO Material Description	P									M				K						
	Non-alloy steel			Low alloy steel			High alloyed steel, and tool steel			Stainless steel		Grey cast iron		Nodular cast iron	Malleable cast iron					
VDI 3323	1	2	3	4	5	6	7	8	9	10	11	12	13	14	15	16	17	18	19	20
HRc	13	25	28	32	30	10	29	32	38	15	35	15	23	10	10	26	3	25	21	
HB	125	190	250	270	300	180	275	300	350	200	325	200	240	180	180	260	160	250	130	230
XMF110V	◎	◎	◎	◎	◎	◎	◎			◎										
XMR110D																				

ISO Material Description	N						S						H								
	Aluminum-wrought alloy		Aluminum-cast, alloyed		Copper and Copper Alloys (Bronze / Brass)		Non Metallic Materials			Heat Resistant Super Alloys			Titanium Alloys		Hardened steel	Chilled Cast Iron	Hardened Cast Iron				
VDI 3323	21	22	23	24	25	26	27	28	29	30	31	32	33	34	35	36	37	38	39	40	41
HRc											15	30	25	38	34	55	60	42	42	55	
HB	60	100	75	90	130	110	90	100			200	280	250	350	320	400 Rm	1050 Rm	550	630	400	550
XMF110V																					
XMR110D	○	○	○	○						◎											

i-Xmill CARBIDE BALL HOLDER - STRAIGHT NECK

● i-Xmill HARTMETAL HALTER für WECHSEL PLATTE mit RUNDER STIRN - mit GERADER SCHAFT
 (●) Porte-plaquette i-Xmill en Carbone, entrée droite, pour plaquette à bout hémisphérique
 (●) CORPO FRESA IN MD PER INSERTI SEMISFERICI i-Xmill - CILINDRICO

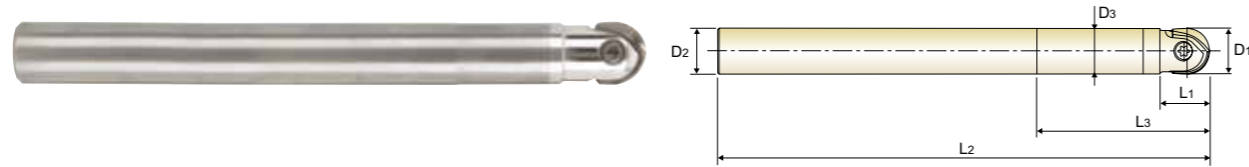

Unit : mm

EDP No.	Mill Diameter	Shank Diameter	Neck Diameter	Length of Cut	Length Below Shank	Overall Length	Length Type	Wrench No.	Screw No.
	D1	D2	D3	L1	L3	L2			
★ ZBC0801080	8	8	7.6	12	25	130	Regular	TWFT07	TX2508T07
★ ZBC0802080	8	8	7.6	12	40	130	Regular		
★ ZBC0803080	8	8	7.6	12	65	130	Regular		
ZBC0804080	8	8	7.6	12	60	150	Regular		
ZBC0805080	8	8	7.6	12	60	200	Long	TWFT08	TX3010T08
ZBC0806080	8	8	7.6	12	25	80	Short		
★ ZBC1001100	10, 11	10	9.5	15	30	140	Regular		
★ ZBC1002100	10, 11	10	9.5	15	50	140	Regular		
★ ZBC1003100	10, 11	10	9.5	15	75	140	Regular	TWFT10	TX3512T10
ZBC1004100	10, 11	10	9.5	15	60	180	Regular		
ZBC1005100	10, 11	10	9.5	15	60	200	Long		
ZBC1006100	10, 11	10	9.5	15	30	80	Short		
ZBC120001P	12, 13	12	11.4	17	40	200	Long	TWFT15	TX4016T15
★ ZBC1201120	12, 13	12	11.4	17	35	150	Regular		
★ ZBC1202120	12, 13	12	11.4	17	60	150	Regular		
★ ZBC1203120	12, 13	12	11.4	17	85	150	Regular		
ZBC1204120	12, 13	12	11.4	17	60	250	Long	TWBT20	TX5020T20
ZBC1205120	12, 13	12	11.4	17	35	100	Short		
ZBC160001P	16, 17	16	15.0	20	50	150	Regular		
★ ZBC1601160	16, 17	16	15.0	20	50	200	Long		
★ ZBC1602160	16, 17	16	15.0	20	80	200	Long	TWBT25	TX6025T25
★ ZBC1603160	16, 17	16	15.0	20	120	200	Long		
★ ZBC1604160	16, 17	16	15.0	20	80	250	Long		
ZBC1605160	16, 17	16	15.0	20	50	120	Short		
ZBC200002P	20, 21	20	19.0	25	60	150	Regular	TWBT30	TX8030T30
★ ZBC2001200	20, 21	20	19.0	25	60	200	Regular		
★ ZBC2002200	20, 21	20	19.0	25	80	200	Regular		
★ ZBC2003200	20, 21	20	19.0	25	100	250	Long		
★ ZBC2004200	20, 21	20	19.0	25	150	250	Long	TWBT25	TX6025T25
ZBC2005200	20, 21	20	19.0	25	100	300	Long		
ZBC250001P	25, 26	25	24.0	30	75	150	Regular		
★ ZBC2501250	25, 26	25	24.0	30	75	200	Regular		
★ ZBC2502250	25, 26	25	24.0	30	120	250	Regular	TWBT30	TX8030T30
★ ZBC2503250	25, 26	25	24.0	30	190	300	Long		
ZBC2504250	25, 26	25	24.0	30	120	350	Long		
ZBC2505250	25, 26	25	24.0	30	60	300	Long		
★ ZBC3001320	30, 32, 33	32	29.0	40	90	250	Regular	TWBT30	TX8030T30
★ ZBC3002320	30, 32, 33	32	29.0	40	150	300	Long		
★ ZBC3003320	30, 32, 33	32	29.0	40	190	300	Long		
ZBC3004320	30, 32, 33	32	29.0	40	120	350	Long		
ZBC3005320	30, 32, 33	32	29.0	40	150	400	Long		

* Upon request, the broken holder is able to be regenerated
 * Your carbide holder can be regenerated as YG-1 type upon request

● Required to use T-HANDLE (TWH600)
 ★ Stock Item

i-Xmill STEEL BALL HOLDER - STRAIGHT NECK

● i-Xmill STAHL HALTER für WECHSEL PLATTE mit RUNDER STIRN - mit GERADER SCHAFT
 (●) Porte-plaquette i-Xmill en acier, entrée droite, pour plaquette à bout hémisphérique
 (●) CORPO FRESA IN ACCIAIO PER INSERTI SEMISFERICI i-Xmill - CILINDRICO

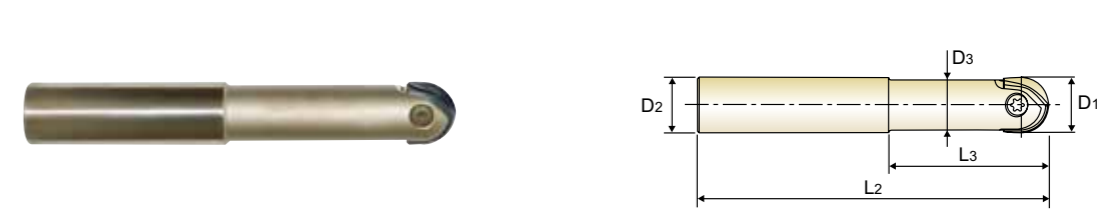

Unit : mm

EDP No.	Mill Diameter	Shank Diameter	Neck Diameter	Length Below Shank	Overall Length	Length Type	Wrench No.	Screw No.
	D1	D2	D3	L3	L2			
★ ZBS1201120	12, 13	12	10.5	35	90	Short	TWFT10	TX3512T10
★ ZBS1202120	12, 13	12	10.5	55	110	Regular		
ZBS120001P	12, 13	12	10.5	40	150	Long	TWFT15	TX4016T15
★ ZBS1601160	16, 17	16	14.5	35	95	Short		
★ ZBS1602160	16, 17	16	14.5	65	125	Regular		
ZBS160001P	16, 17	16	14.5	60	200	Long		
★ ZBS2001200	20, 21	20	18.0	40	110	Short	TWBT20	TX5020T20
★ ZBS2002200	20, 21	20	18.0	75	145	Regular		
ZBS200001P	20, 21	20	18.0	80	200	Long		
ZBS200002P	20, 21	20	18.0	60	200	Long		
★ ZBS2501250	25, 26	25	22.5	45	125	Short	TWBT25	TX6025T25
★ ZBS2502250	25, 26	25	22.5	90	170	Regular		
ZBS2503250	25, 26	25	22.5	100	250	Long		
ZBS250001P	25, 26	25	22.5	90	200	Long		
ZBS250002P	25, 26	25	22.5	60	200	Long	TWBT30	TX8030T30
★ ZBS3001320	30, 32, 33	32	27.0	55	140	Short		
★ ZBS3002320	30, 32, 33	32	27.0	110	195	Regular		
ZBS3004320	30, 32, 33	32	27.0	150	350	Long		
ZBS300001P	30, 32, 33	32	27.0	100	250	Long		

● Required to use T-HANDLE (TWH600)
 ★ Stock Item



ZBT SERIES



ZRC SERIES

i-Xmill STEEL BALL HOLDER - TAPER NECK

● i-Xmill STAHL HALTER für WECHSEL PLATTE mit RUNDER STIRN - mit KONISCH ABGESETZTEM SCHAFTTEIL
 (●) Porte-plaquette i-Xmill en acier, entrée conique, pour plaquette à bout hémisphérique
 (●) CORPO FRESA IN ACCIAIO PER INSERTI SEMISFERICI i-Xmill - CONICO



Unit : mm

EDP No.	Mill Diameter	Shank Diameter	Neck Diameter	Length of Cut	Length Below Shank	Overall Length	Interference Angle	Length Type	Wrench No.	Screw No.
	D1	D2	D3	L1	L3	L2	θ°			
★ ZBT0801120	8	12	7.2	12	35	90	4° 43'	Short	TWFT07	TX2508T07
★ ZBT0802120	8	12	7.2	25	55	110	3° 37'	Regular		
★ ZBT1001120	10, 11	12	9.0	15	35	90	2° 51'	Short	TWFT08	TX3010T08
★ ZBT1002120	10, 11	12	9.0	30	55	110	2° 17'	Regular		
★ ZBT1201160	12, 13	16	10.5	17	55	110	3° 23'	Short	TWFT10	TX3512T10
★ ZBT1601200	16, 17	20	14.5	20	65	125	2° 51'	Short		
ZBT1604200	16, 17	20	14.5	20	115	200	1° 22'	Regular	TWFT15	TX4016T15
★ ZBT2001250	20, 21	25	18.0	25	75	145	3° 26'	Short		
ZBT2004250	20, 21	25	18.0	25	115	200	1° 55'	Regular	●TWBT20	TX5020T20
ZBT2005250	20, 21	25	18.0	25	160	250	1° 17'	Long		
★ ZBT2501320	25, 26	32	22.5	30	90	170	4° 03'	Short	●TWBT25	TX6025T25
ZBT2504320	25, 26	32	22.5	30	160	250	1° 53'	Regular		
ZBT2505320	25, 26	32	22.5	30	190	300	1° 32'	Long	●TWBT30	TX8030T30
★ ZBT3001320	30,32,33	32	27.0	40	110	195	1° 38'	Short		
ZBT3004320	30,32,33	32	27.0	40	160	250	0° 58'	Regular		
ZBT3005320	30,32,33	32	27.0	40	190	300	0° 46'	Long		

● Required to use T-HANDLE (TWH600)
 ★ Stock Item

i-Xmill CARBIDE CORNER RADIUS HOLDER - STRAIGHT NECK

● i-Xmill HARTMETAL HALTER für WECHSEL PLATTE mit ECKRADIUS - mit GERADER SCHAFT
 (●) Porte-plaquette i-Xmill en Carbure, entrée droite, pour plaquette à bout torique
 (●) CORPO FRESA IN MD PER INSERTI TORICI i-Xmill - CILINDRICO

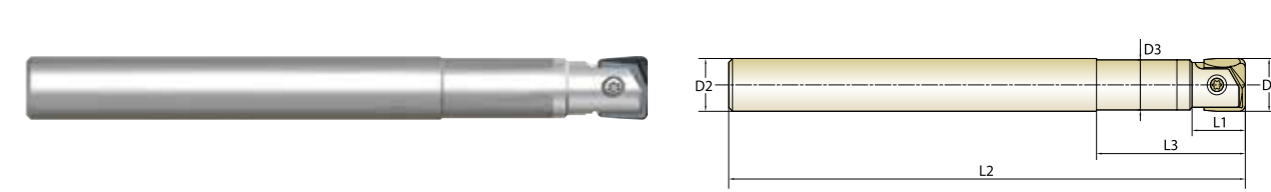

Unit : mm

EDP No.	Mill Diameter	Shank Diameter	Neck Diameter	Length of Cut	Length Below Shank	Overall Length	Length Type	Wrench No.	Screw No.
	D1	D2	D3	L1	L3	L2			
★ ZRC0801080	8	8	7.6	12	25	130	Regular	TWFT07	TX2508T07
★ ZRC0802080	8	8	7.6	12	40	130	Regular		
★ ZRC0803080	8	8	7.6	12	65	130	Regular	TWFT08	TX3010T08
★ ZRC1001100	10	10	9.5	15	30	140	Regular		
★ ZRC1002100	10	10	9.5	15	50	140	Regular	TWFT10	TX3512T10
★ ZRC1201120	12, 13	12	11.4	17	35	150	Regular		
★ ZRC1202120	12, 13	12	11.4	17	60	150	Regular	TWFT15	TX4016T15
★ ZRC1203120	12, 13	12	11.4	17	85	150	Regular		
★ ZRC1601160	16, 17	16	15.0	20	50	200	Long	TWFT15	TX4016T15
★ ZRC1602160	16, 17	16	15.0	20	80	200	Long		
★ ZRC1603160	16, 17	16	15.0	20	120	200	Long	●TWBT20	TX5020T20
★ ZRC1604160	16, 17	16	15.0	20	80	250	Long		
★ ZRC2001200	20, 21	20	19.0	25	60	200	Regular	TWFT20	TX5020T20
★ ZRC2002200	20, 21	20	19.0	25	80	250	Regular		
★ ZRC2003200	20, 21	20	19.0	25	100	250	Long	TWFT25	TX6025T25
★ ZRC2004200	20, 21	20	19.0	25	150	250	Long		
★ ZRC2501250	25, 26	25	24.0	30	75	200	Regular	TWFT30	TX8030T30
★ ZRC2502250	25, 26	25	24.0	30	120	250	Regular		
★ ZRC2503250	25, 26	25	24.0	30	190	300	Long	TWFT30	TX8030T30
★ ZRC3001320	30,32,33	32	29.0	40	90	250	Regular		
★ ZRC3002320	30,32,33	32	29.0	40	150	300	Long	TWFT30	TX8030T30
★ ZRC3003320	30,32,33	32	29.0	40	190	300	Long		

● Required to use T-HANDLE (TWH600)
 ★ Stock Item

i-Xmill STEEL CORNER RADIUS HOLDER - STRAIGHT NECK

- i-Xmill STAHL HALTER für WECHSEL PLATTE mit ECKRADIUS - mit GERADER SCHAFT
- () Porte-plaquette i-Xmill en acier, entrée droite, pour plaquette torique
- () CORPO FRESA IN ACCIAIO PER INSERTI TORICI i-Xmill - CILINDRICO

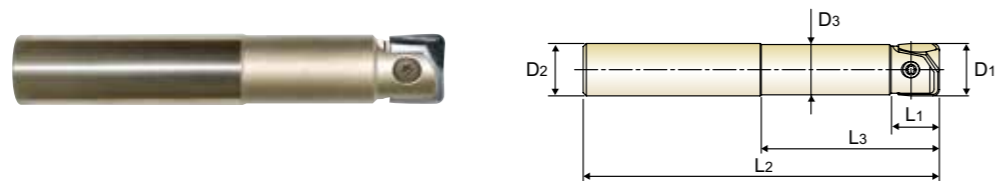

Unit : mm

EDP No.	Mill Diameter	Shank Diameter	Neck Diameter	Length of Cut	Length Below Shank	Overall Length	Length Type	Wrench No.	Screw No.
	D1	D2	D3	L1	L3	L2			
★ ZRS1201120	12, 13	12	11.0	13	30	110	Regular	TWFT10	TX3512T10
★ ZRS1601160	16, 17	16	15.0	15	50	130	Regular	TWFT15	TX4016T15
★ ZRS1602160	16, 17	16	15.0	15	65	165	Intermediate		
ZRS1603160	16, 17	16	15.0	15	65	200	Long	● TWBT20	TX5020T20
★ ZRS2001200	20, 21	20	19.0	18	60	140	Regular		
★ ZRS2002200	20, 21	20	19.0	18	80	180	Intermediate	● TWBT25	TX6025T25
ZRS2003200	20, 21	20	19.0	18	80	250	Long		
★ ZRS2501250	25, 26	25	24.0	23	70	150	Regular	● TWBT30	TX8030T30
★ ZRS2502250	25, 26	25	24.0	23	90	200	Intermediate		
ZRS2503250	25, 26	25	24.0	23	90	300	Long	● TWBT30	TX8030T30
★ ZRS3001320	30, 32, 33	32	29.0	27	80	160	Regular		
★ ZRS3002320	30, 32, 33	32	29.0	27	100	220	Intermediate	● TWBT30	TX8030T30
ZRS3003320	30, 32, 33	32	29.0	27	100	350	Long		

- Required to use T-HANDLE (TWH600)
- ★ Stock Item

i-Xmill STEEL CORNER RADIUS HOLDER - TAPER NECK

- i-Xmill STAHL HALTER für WECHSEL PLATTE mit ECKRADIUS - mit KONISCH ABGESETZTEM SCHAFTTEIL
- () Porte-plaquette i-Xmill en acier, entrée conique, pour plaquette torique
- () CORPO FRESA IN ACCIAIO PER INSERTI TORICI i-Xmill - CONICO



Unit : mm

EDP No.	Mill Diameter	Shank Diameter	Neck Diameter	Length of Cut	Length Below Shank	Overall Length	Interference Angle	Length Type	Wrench No.	Screw No.
	D1	D2	D3	L1	L3	L2	θ°			
★ ZRT0801120	8	12	6.7	10	22	100	9°	Regular	TWFT07	TX2508T07
★ ZRT0802120	8	12	6.7	10	50	130	2° 43'	Long	TWFT08	TX3010T08
★ ZRT1001120	10, 11	12	8.6	13	25	100	4° 45'	Regular		
★ ZRT1002120	10, 11	12	8.6	13	50	150	1° 32'	Long	TWFT10	TX3512T10
★ ZRT1202160	12, 13	16	10.2	15	60	160	2° 32'	Long		

- ★ Stock Item

ASSEMBLY of i-Xmill
MONTAGE DES i-Xmill

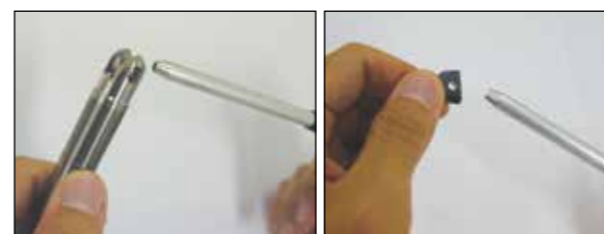

- ▲ Make sure to clean the insert and insert seat.
Wechselplatte und Plattensitz sorgfältig reinigen.

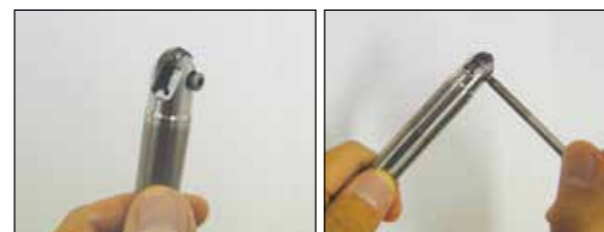

- ▲ Slide the insert into the slot of the holder.
Tighten the screw using anti-seize compound.
Wechselplatte in den Sitz des Halters einführen.
Die Schraube fest anziehen und dabei Spezialfett verwenden

SIZE (ØD)	CLAMPING TORQUE [N·m]
Ø8.0	1.0
Ø10.0	1.5
Ø12.0, Ø13.0	2.5
Ø16.0, Ø17.0	3.5
Ø20.0, Ø21.0	5.0
Ø25.0, Ø26.0	6.0
Ø30.0, Ø32.0	6.5

- * When the screw is worn out, please change the a new screw.
* Wenn das Schraubengewinde verschlissen ist, bitte neue Schraube verwenden.
- * Please tighten up the screw with recommended torque. (Please refer to the table)
* Die Feststellschraube mit dem empfohlenen Anzugsmoment anziehen (siehe Tabelle).
- * Don't press down the insert, when the screw is tightened.
* Die Wechselplatte nicht nach unten drücken, wenn die Schraube angezogen ist.



Wrench No.

WRENCH TYPE	PRODUCT NO.	T-HANDLE No.
WING TYPE	TWFT10	-
	TWFT15	-
TORX BIT TYPE	● TWBT20	TWH600
	● TWBT25	
	● TWBT30	

- Required to use T-HANDLE (TWH600)

CUTTING CONDITION
SCHNEIDKONDITIONEN

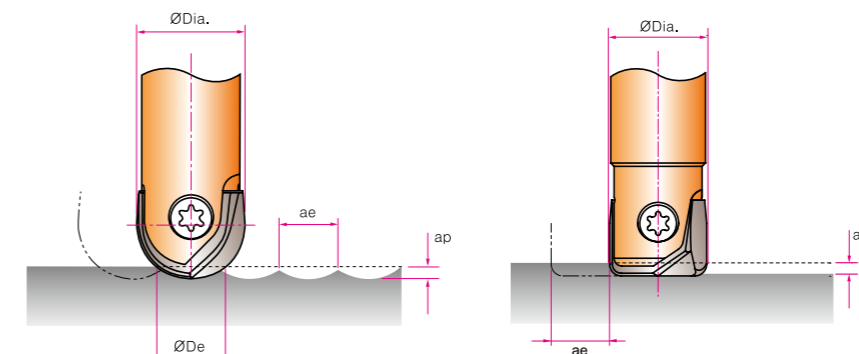

- RPM = revolution per minute (rev/min)
- Vc = surface meter per minute (M/min)
- Dia. = diameter of insert (mm)
- Vf = feed speed (mm/min)
- f = feed per revolution (mm/rev)
- De = effective tool diameter (mm)
- ap = axial depth of cut (mm)
- ae = radial depth of cut (mm)

$$Vc [M/min] = \frac{(RPM) \cdot (\pi) \cdot (Dia.)}{1000}$$

$$RPM [rev/min] = \frac{(Vc) \cdot (1000)}{(\pi) \cdot (Dia.)}$$

$$Vf [mm/min] = (RPM) \cdot (f)$$

$$De [mm] = 2 \cdot \sqrt{(ap) \cdot (Dia. - ap)}$$

XMB110A SERIES BALL INSERTS for GENERAL PURPOSE

Vc = m/min.
Fz = mm/tooth
RPM = rev./min.
FEED = mm/min.

ISO	VDI 3323	Material Description	Parameter	Diameter (Ø)							
				8	10, 11	12, 13	16, 17	20, 21	25, 26	30, 32, 33	
P	1-4	Non-alloy steel	Vc	160~320	160~360	160~380	160~480	160~580	160~600	160~700	
			fz	0.20~0.20	0.20~0.20	0.20~0.20	0.25~0.30	0.25~0.40	0.25~0.50	0.25~0.60	
			RPM	6370~12730	5090~11460	4240~10080	3180~9550	2550~9230	2040~7640	1700~7430	
			FEED	2550~5090	2040~4580	1700~4030	1590~5730	1270~7380	1020~7640	850~8910	
	5	Non-alloy steel	Vc	120~280	120~300	120~350	120~380	120~420	120~480	120~550	
			fz	0.20~0.20	0.20~0.20	0.20~0.20	0.25~0.30	0.25~0.40	0.25~0.50	0.25~0.60	
			RPM	4770~11140	3820~9550	3180~9280	2390~7560	1910~6680	1530~6110	1270~5840	
			FEED	1910~4460	1530~3820	1270~3710	1190~4540	950~5350	760~6110	640~7000	
	6-7	Low alloy steel	Vc	160~320	160~360	160~380	160~480	160~580	160~600	160~700	
			fz	0.20~0.20	0.20~0.20	0.20~0.20	0.25~0.30	0.25~0.40	0.25~0.50	0.25~0.60	
			RPM	6370~12730	5090~11460	4240~10080	3180~9550	2550~9230	2040~7640	1700~7430	
			FEED	2550~5090	2040~4580	1700~4030	1590~5730	1270~7380	1020~7640	850~8910	
8	Low alloy steel	Vc	120~280	120~300	120~350	120~380	120~420	120~480	120~550		
		fz	0.20~0.20	0.20~0.20	0.20~0.20	0.25~0.30	0.25~0.40	0.25~0.50	0.25~0.60		
		RPM	4770~11140	3820~9550	3180~9280	2390~7560	1910~6680	1530~6110	1270~5840		
		FEED	1910~4460	1530~3820	1270~3710	1190~4540	950~5350	760~6110	640~7000		

XMB120C SERIES BALL INSERTS for PRE-HARDENED STEELS

ISO	VDI 3323	Material Description	Parameter	Diameter (Ø)							
				8	10, 11	12, 13	16, 17	20, 21	25, 26	30, 32, 33	
P	9-11	Low alloy steel, High alloyed steel, and tool steel	Vc	100~220	100~260	100~280	100~350	100~400	100~450	100~500	
			fz	0.15~0.20	0.15~0.20	0.15~0.20	0.20~0.30	0.20~0.40	0.20~0.50	0.20~0.60	
			RPM	3980~8750	3180~8280	2650~7430	1990~6960	1590~6370	1270~5730	1060~5310	
K	15-20	Grey cast iron, Nodular cast iron, Malleable cast iron	Vc	160~320	160~360	160~400	160~500	160~550	160~620	160~720	
			fz	0.30~0.30	0.30~0.30	0.30~0.30	0.35~0.40	0.35~0.40	0.35~0.50	0.35~0.60	
			RPM	6370~12730	5090~11460	4240~10610	3180~9950	2550~8750	2040~7890	1700~7640	
H	38	Hardened steel	Vc	80~180	80~200	80~220	80~260	80~320	80~360	80~400	
			fz	0.10~0.20	0.10~0.20	0.10~0.20	0.15~0.30	0.15~0.40	0.15~0.50	0.15~0.60	
			RPM	3180~7160	2550~6370	2120~5840	1590~5170	1270~5090	1020~4580	850~4240	
			FEED	640~2860	510~2550	420~2330	480~3100	380~4070	310~4580	250~5090	

XMB260T SERIES BALL INSERTS for HIGH HARDENED STEELS

ISO	VDI 3323	Material Description	Parameter	Diameter (Ø)							
				8	10, 11	12, 13	16, 17	20, 21	25, 26	30, 32, 33	
H	38-41	Hardened steel	Vc	80~180	80~200	80~220	80~260	80~320	80~360	80~400	
			fz	0.10~0.15	0.10~0.15	0.10~0.15	0.15~0.25	0.15~0.25	0.15~0.25	0.15~0.30	
			RPM	3180~7160	2550~6370	2120~5840	1590~5170	1270~5090	1020~4580	850~4240	
			FEED	640~2150	510~1910	420~1750	480~2590	380~2550	310~2290	250~2550	

XMB130A SERIES BALL INSERTS for STAINLESS STEELS

ISO	VDI 3323	Material Description	Parameter	Diameter (Ø)							
				8	10, 11	12, 13	16, 17	20, 21	25, 26	30, 32, 33	
M	12-14	Stainless steel	Vc	90~130	90~130	90~130	90~130	90~130	90~130	90~130	
			fz	0.10~0.12	0.13~0.15	0.15~0.20	0.15~0.20	0.15~0.20	0.20~0.25	0.20~0.25	
			RPM	3580~5170	2860~4140	2390~3450	1790~2590	1430~2070	1150~1660	950~1380	
			FEED	720~1290	720~1240	720~1380	540~1030	430~830	460~830	380~690	

XMM110V SERIES BALL INSERTS for GENERAL PURPOSE - FULL RADIUS

Vc = m/min.
Fz = mm/tooth
RPM = rev./min.
FEED = mm/min.

ISO	VDI 3323	Material Description	Parameter	Diameter (Ø)							
				8	10, 11	12, 13	16, 17	20, 21	25, 26	30, 32, 33	
P	1-4	Non-alloy steel	Vc	160~320	160~360	160~380	160~480	160~580	160~600	160~700	
			fz	0.20~0.20	0.20~0.20	0.20~0.20	0.25~0.30	0.25~0.40	0.25~0.50	0.25~0.60	
			RPM	6370~12730	5090~11460	4240~10080	3180~9550	2550~9230	2040~7640	1700~7430	
			FEED	2550~5090	2040~4580	1700~4030	1590~5730	1270~7380	1020~7640	850~8910	
	6-7	Low alloy steel	Vc	160~320	160~360	160~380	160~480	160~580	160~600	160~700	
			fz	0.20~0.20	0.20~0.20	0.20~0.20	0.25~0.30	0.25~0.40	0.25~0.50	0.25~0.60	
			RPM	6370~12730	5090~11460	4240~10080	3180~9550	2550~9230	2040~7640	1700~7430	
			FEED	2550~5090	2040~4580	1700~4030	1590~5730	1270~7380	1020~7640	850~8910	
	10	High alloyed steel, and tool steel	Vc	160~320	160~360	160~380	160~480	160~580	160~600	160~700	
			fz	0.20~0.20	0.20~0.20	0.20~0.20	0.25~0.30	0.25~0.40	0.25~0.50	0.25~0.60	
			RPM	6370~12730	5090~11460	4240~10080	3180~9550	2550~9230	2040~7640	1700~7430	
			FEED	2550~5090	2040~4580	1700~4030	1590~5730	1270~7380	1020~7640	850~8910	

XMB110D SERIES BALL INSERTS for GRAPHITE

ISO	VDI 3323	Material Description	Parameter	Diameter (Ø)							
				8	10, 11	12, 13	16, 17	20, 21	25, 26	30, 32, 33	
N	21~22	Aluminum-wrought alloy	Vc	300~400	300~400	300~400	300~400	300~480	300~560	300~650	
			fz	0.20~0.20	0.20~0.20	0.20~0.20	0.20~0.30	0.30~0.35	0.35~0.40	0.40~0.50	
			RPM	11940~15920	9550~12730	7960~10610	5970~7960	4770~7640	3820~7130	3180~6900	
N	23~24	Aluminum-cast, alloyed	Vc	300~400	300~400	300~400	300~400	300~480	300~560	300~650	
			fz	0.20~0.20	0.20~0.20	0.20~0.20	0.25~0.30	0.30~0.35	0.35~0.40	0.40~0.50	
			RPM	11940~15920	9550~12730	7960~10610	5970~7960	4770~7640	3820~7130	3180~6900	
N	29.2	Graphite	Vc	300~400	300~400	300~400	300~400	300~480	300~560	300~650	
			fz	0.20~0.20	0.20~0.20	0.20~0.20	0.25~0.30	0.30~0.35	0.35~0.40	0.40~0.50	
			RPM	11940~15920	9550~12730	7960~10610	5970~7960	4770~7640	3820~7130	3180~6900	
			FEED	4770~6370	3820~5090	3180~4240	2980~4770	2860~5350	2670~5700	2550~6900	

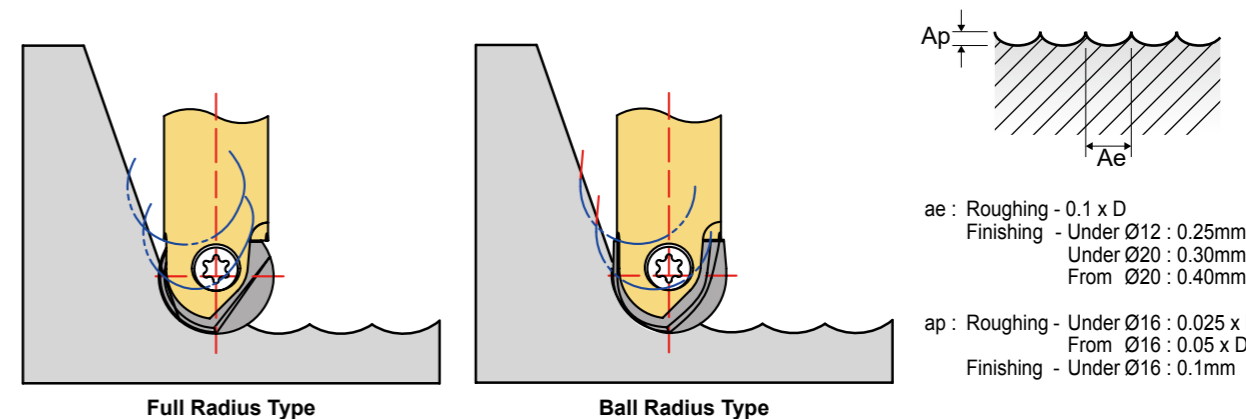

- ▶ When the length of overhang exceeds 4xD, we recommend using the carbide shank holder with 20% lower feed
- ▶ When using long (long & intermediate type holder) tools, we recommend reducing the feed rate to 70 ~ 85%.

XMR110A SERIES CORNER RADIUS INSERTS for GENERAL PURPOSE & STAINLESS STEELS

Vc = m/min.
Fz = mm/tooth
RPM = rev./min.
FEED = mm/min.

ISO	VDI 3323	Material Description	Parameter	Diameter (Ø)							
				8	10, 11	12, 13	16, 17	20, 21	25, 26	30, 32, 33	
P	1-4	Non-alloy steel	Vc	160~300	160~300	160~300	160~300	160~300	160~300	160~300	160~300
			fz	0.20~0.15	0.20~0.15	0.20~0.15	0.25~0.20	0.25~0.20	0.25~0.20	0.25~0.20	0.25~0.20
			RPM	6370~11940	5090~9550	4240~7960	3180~5970	2550~4770	2040~3820	1700~3180	
			FEED	2550~3580	2040~2860	1700~2390	1590~2390	1270~1910	1020~1530	850~1270	
	5	Non-alloy steel	Vc	120~280	120~280	120~280	120~280	120~280	120~280	120~280	120~280
			fz	0.20~0.15	0.20~0.15	0.20~0.15	0.25~0.20	0.25~0.20	0.25~0.20	0.25~0.20	0.25~0.20
			RPM	4770~11140	3820~8910	3180~7430	2390~5570	1910~4460	1530~3570	1270~2970	
			FEED	1910~3340	1530~2670	1270~2230	1190~2230	950~1780	760~1430	640~1190	
	6-7	Low alloy steel	Vc	160~300	160~300	160~300	160~300	160~300	160~300	160~300	160~300
			fz	0.20~0.15	0.20~0.15	0.20~0.15	0.25~0.20	0.25~0.20	0.25~0.20	0.25~0.20	0.25~0.20
			RPM	6370~11940	5090~9550	4240~7960	3180~5970	2550~4770	2040~3820	1700~3180	
			FEED	2550~3580	2040~2860	1700~2390	1590~2390	1270~1910	1020~1530	850~1270	
8	Low alloy steel	Vc	120~280	120~280	120~280	120~280	120~280	120~280	120~280	120~280	
		fz	0.20~0.15	0.20~0.15	0.20~0.15	0.25~0.20	0.25~0.20	0.25~0.20	0.25~0.20	0.25~0.20	
		RPM	4770~11140	3820~8910	3180~7430	2390~5570	1910~4460	1530~3570	1270~2970		
		FEED	1910~3340	1530~2670	1270~2230	1190~2230	950~1780	760~1430	640~1190		
M	12-14	Stainless steel	Vc	90~130	90~130	90~130	90~130	90~130	90~130	90~130	90~130
			fz	0.10~0.10	0.11~0.11	0.12~0.11	0.13~0.13	0.13~0.13	0.13~0.12	0.13~0.12	
			RPM	3580~5170	2860~4140	2390~3450	1790~2590	1430~2070	1150~1660	950~1380	
			FEED	720~1030	630~910	550~790	450~650	360~520	290~410	240~340	

XMR120C SERIES CORNER RADIUS INSERTS for PRE-HARDENED STEELS

ISO	VDI 3323	Material Description	Parameter	Diameter (Ø)							
				8	10, 11	12, 13	16, 17	20, 21	25, 26	30, 32, 33	
P	9-11	Low alloy steel High alloyed steel, and tool steel	Vc	100~280	100~280	100~280	100~280	100~280	100~280	100~280	100~280
			fz	0.12~0.06	0.13~0.06	0.13~0.06	0.15~0.08	0.15~0.08	0.15~0.08	0.15~0.08	0.15~0.08
			RPM	3980~11140	3180~8910	2650~7430	1990~5570	1590~4460	1270~3570	1060~2970	
			FEED	990~1340	800~1070	690~890	600~840	480~670	380~570	320~450	
K	15-20	Grey cast iron Nodular cast iron Malleable cast iron	Vc	160~380	160~380	160~380	160~380	160~380	160~380	160~380	160~380
			fz	0.30~0.20	0.30~0.20	0.30~0.20	0.35~0.30	0.35~0.30	0.35~0.30	0.35~0.30	
			RPM	6370~15120	5090~12100	4240~10080	3180~7560	2550~6050	2040~4840	1700~4030	
			FEED	3820~6050	3060~4840	2550~4030	2230~4540	1780~3630	1430~2900	1190~2420	
H	38	Hardened steel	Vc	80~220	80~220	80~220	80~220	80~220	80~220	80~220	80~220
			fz	0.10~0.05	0.10~0.05	0.10~0.05	0.15~0.06	0.15~0.06	0.15~0.06	0.15~0.06	
			RPM	3180~8750	2550~7000	2120~5840	1590~4380	1270~3500	1020~2800	850~2330	
			FEED	640~880	510~700	420~580	420~530	380~420	310~340	250~280	

XMR260T SERIES CORNER RADIUS INSERTS for HIGH HARDENED STEELS

ISO	VDI 3323	Material Description	Parameter	Diameter (Ø)							
				8	10, 11	12, 13	16, 17	20, 21	25, 26	30, 32, 33	
H	38-41	Hardened steel	Vc	80~220	80~220	80~220	80~220	80~220	80~220	80~220	80~220
			fz	0.10~0.05	0.10~0.05	0.10~0.05	0.15~0.06	0.15~0.06	0.15~0.06	0.15~0.06	
			RPM	3180~8750	2550~7000	2120~5840	1590~4380	1270~3500	1020~2800	850~2330	
			FEED	640~880	510~700	420~580	480~530	380~420	310~340	250~280	

XMF110V SERIES CORNER RADIUS INSERTS for GENERAL PURPOSE - HIGH FEED

Vc = m/min.
Fz = mm/tooth
RPM = rev./min.
FEED = mm/min.

ISO	VDI 3323	Material Description	Parameter	Diameter (Ø)							
				8	10, 11	12, 13	16, 17	20, 21	25, 26	30, 32, 33	
P	1-7	Non-alloy steel Low alloy steel	Vc	150~200	150~200	150~200	150~200	150~200	150~200	150~200	150~200
			fz	0.60~0.40	0.75~0.50	0.90~0.60	1.20~0.80	1.50~1.00	1.80~1.40	2.30~1.80	
			RPM	5970~7960	4770~6370	3980~5310	2980~3980	2390~3180	1910~2550	1590~2120	
			FEED	7160~6370	7160~6370	7160~6370	7160~6370	7160~6370	6880~7140	7320~7640	
	10	High alloyed steel, and tool steel	Vc	150~200	150~200	150~200	150~200	150~200	150~200	150~200	150~200
			fz	0.60~0.40	0.75~0.50	0.90~0.60	1.20~0.80	1.50~1.00	1.80~1.40	2.30~1.80	
			RPM	5970~7960	4770~6370	3980~5310	2980~3980	2390~3180	1910~2550	1590~2120	
			FEED	7160~6370	7160~6370	7160~6370	7160~6370	7160~6370	6880~7140	7320~7640	
			Ap(Max)	0.4	0.5	0.6	0.8	1.0	1.3	1.6	
			Vc	150~200	150~200	150~200	150~200	150~200	150~200	150~200	
			fz	0.60~0.40	0.75~0.50	0.90~0.60	1.20~0.80	1.50~1.00	1.80~1.40	2.30~1.80	
			RPM	5970~7960	4770~6370	3980~5310	2980~3980	2390~3180	1910~2550	1590~2120	
			FEED	7160~6370	7160~6370	7160~6370	7160~6370	7160~6370	6880~7140	7320~7640	
			Ap(Max)	0.4	0.5	0.6	0.8	1.0	1.3	1.6	

XMR110D SERIES CORNER RADIUS INSERTS for GRAPHITE

ISO	VDI 3323	Material Description	Parameter	Diameter (Ø)							
				8	10, 11	12, 13	16, 17	20, 21	25, 26	30, 32, 33	
N	21~22	Aluminum-wrought alloy	Vc	300~400	300~400	300~400	300~400	300~400	300~400	300~400	300~400
			fz	0.20~0.20	0.20~0.20	0.20~0.20	0.20~0.20	0.25~0.25	0.25~0.25	0.25~0.25	
			RPM	11940~15920	9550~12730	7960~10610	5970~7960	4770~6370	3820~5090	3180~4240	
			FEED	4770~6370	3820~5090	3180~4240	2390~3180	2390~3180	1910~2550	1590~2120	
N	23~24	Aluminum-cast, alloyed	Vc	300~400	300~400	300~400	300~400	300~400	300~400	300~400	300~400
			fz	0.20~0.20	0.20~0.20	0.20~0.20	0.20~0.20	0.25~0.25	0.25~0.25	0.25~0.25	
			RPM	11940~15920	9550~12730	7960~10610	5970~7960	4770~6370	3820~5090	3180~4240	
			FEED	4770~6370	3820~5090	3180~4240	2390~3180	2390~3180	1910~2550	1590~2120	
N	29.2	Graphite	Vc	300~400	300~400	300~400	300~400	300~400	300~400	300~400	300~400
			fz	0.20~0.20	0.20~0.20	0.20~0.20	0.20~0.20	0.25~0.25	0.25~0.25	0.25~0.25	
			RPM	11940~15920	9550~12730	7960~10610	5970~7960	4770~6370	3820~5090	3180~4240	
			FEED	4770~6370	3820~5090	3180~4240	2390~3180	2390~3180	1910~2550	1590~2120	

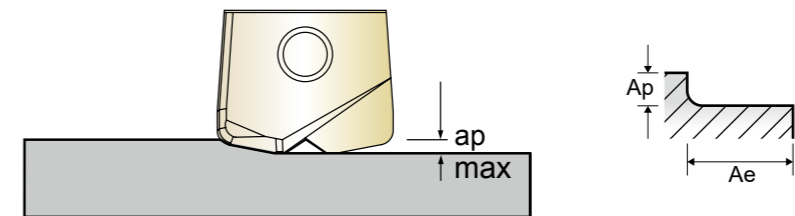

ae : Roughing - 0.1 x D
Finishing - 0.2mm

ap : Roughing - Under Ø16 : 0.025 x D
From Ø16 : 0.05 x D
Finishing - Under Ø16 : 0.1mm
From Ø16 : 0.2mm

- ▶ When the length of overhang exceeds 4xD, we recommend using the carbide shank holder with 20% lower feed
- ▶ When using long (long & intermediate type holder) tools, we recommend reducing the feed rate to 70 ~ 85%.



Global Cutting Tool Leader **YG-1**



MILLING



Leading Through Innovation

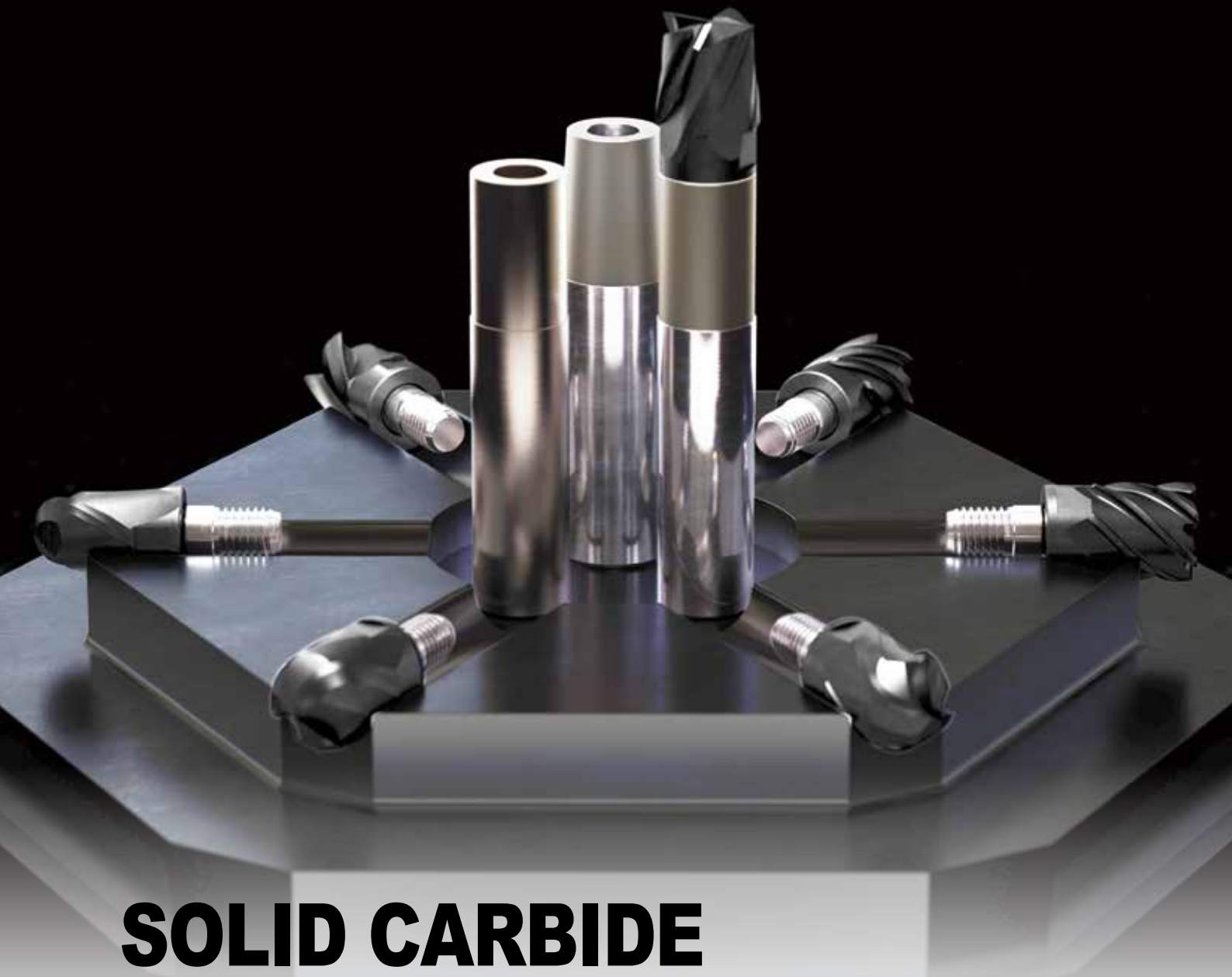

SOLID CARBIDE

***i* - SMART MODULAR TYPE
END MILL**

i-Smart, Schafffräser mit auswechselbaren VHM Schneidköpfen

- For General Steels, Hardened Steels and Cast Iron
- Für allgemeine Stähle, gehärtete Stähle und Gusseisen

SELECTION GUIDE



CARBIDE MODULAR i-SMART HEAD & HOLDER END MILLS

Ultra-micro Grain Carbide Heads with Carbide & Steel Holders



Please visit globalyg1.com/mat for material search

⊙ : Excellent ○ : Good

Recommended cutting conditions : p.C79

Table with 3 columns: SERIES, FLUTE, HELIX ANGLE, CUTTING EDGE SHAPE, SIZE MIN, SIZE MAX, PAGE. Rows include XSEMD98, XSEME59, XSEME60.

Table with 3 columns: CENTER MATCH, Y-Coating. Rows include XSEMD98, XSEME59, XSEME60.



Table with 4 columns: XSEME01, XSEME68, XSEME36, XSEME75. Rows include FLUTE, HELIX ANGLE, CORNER RADIUS, D, D32.0, C71, C72, C74, C75.

Table with 4 columns: Y-Coating. Rows include XSEME01, XSEME68, XSEME36, XSEME75.

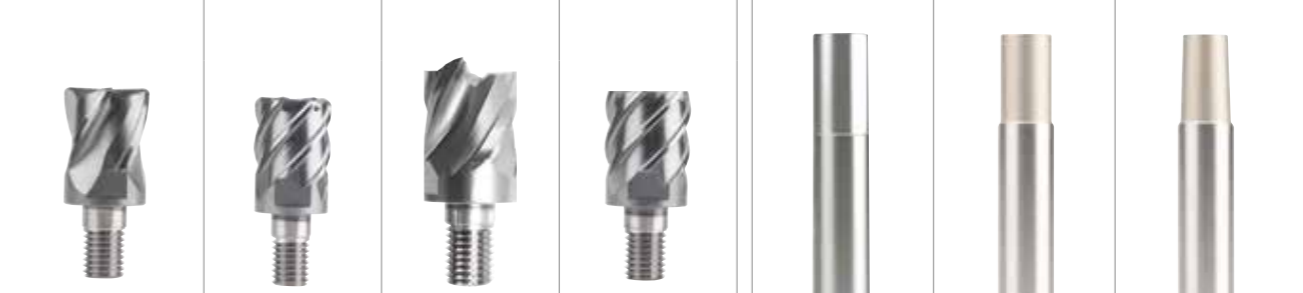

Table with 3 columns: ZMC, ZMS, ZMT. Rows include FLUTE, HELIX ANGLE, CORNER RADIUS, D, D32.0, C76, C77, C78.

Table with 3 columns: STRAIGHT NECKTYPE, TAPER NECKTYPE. Rows include ZMC, ZMS, ZMT.



Large table with columns: ISO, VDI 3323, Material Description, Composition / Structure / Heat Treatment, HB, HRc, and application categories (P, M, K, N, S, H) with corresponding performance indicators.

Large table with columns: application categories (P, M, K, N, S, H) and performance indicators (○, ⊙).

CARBIDE MODULAR HEAD, 2 FLUTE BALL NOSE (Center Match)

- Vollhartmetall, 2 Schneiden mit Stirnradius (Schneiden Mittelpunkt)
- CARBURE TÊTE MODULAIRE, 2 DENTS À BOUT HÉMISPHERIQUE (Coupe au Centre)
- TESTINA MODULARE IN MD, 2 TAGLIENTI, SEMISFERICA

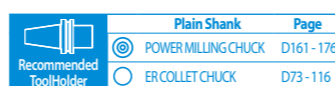
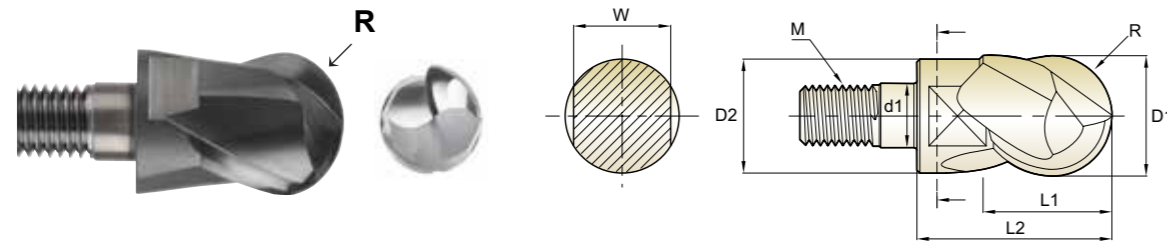

Unit : mm

EDP No.	Radius of Ball Nose	Mill Diameter	Neck Diameter	Length of Cut	Length Below Shank	Wrench Width	Coupling Diameter	Thread
Y-COATED	R	D1	D2	L1	L2	W	d1	M
XSEMD98100	R5.0	10.0	9.2	10	17.5	8	6.5	M6
XSEMD98120	R6.0	12.0	11.2	12	20.5	10	6.5	M6
XSEMD98160	R8.0	16.0	15.0	16	25.5	13	8.5	M8
XSEMD98200	R10.0	20.0	19.0	20	30.0	17	10.5	M10
XSEMD98250	R12.5	25.0	24.0	25	37.0	22	12.5	M12
XSEMD98300	R15.0	30.0	29.0	30	43.0	27	17.0	M16
XSEMD98320	R16.0	32.0	31.0	32	45.0	27	17.0	M16

Radius Tolerance(mm)	Mill Dia. Tolerance(mm)
± 0.010	0 ~ - 0.02

◎ : Excellent ○ : Good

ISO	P										M					K					
	Non-alloy steel					Low alloy steel					High alloyed steel, and tool steel					Stainless steel		Grey cast iron		Nodular cast iron	Malleable cast iron
Material Description	1	2	3	4	5	6	7	8	9	10	11	12	13	14	15	16	17	18	19	20	
VDI 3323	1	2	3	4	5	6	7	8	9	10	11	12	13	14	15	16	17	18	19	20	
HRc	13	25	28	32	38	10	29	32	38	45	15	35	40	48	20	26	3	25	21	21	
HB	125	190	250	270	300	180	275	300	350	400	200	240	180	180	180	260	160	250	130	230	
Recommend	○	○	○	◎	◎	○	◎	◎	◎	◎	○	○	○	○	○	○	○	○	○	○	

ISO	N					S					H										
	Aluminum-wrought alloy		Aluminum-cast, alloyed		Copper and Copper Alloys (Bronze / Brass)	Non Metallic Materials		Heat Resistant Super Alloys					Titanium Alloys		Hardened steel	Chilled Cast Iron	Hardened Cast Iron				
Material Description	21	22	23	24	25	26	27	28	29	30	31	32	33	34	35	36	37	38	39	40	41
VDI 3323	21	22	23	24	25	26	27	28	29	30	31	32	33	34	35	36	37	38	39	40	41
HRc	21	22	23	24	25	26	27	28	29	30	31	32	33	34	35	36	37	38	39	40	41
HB	60	100	75	90	130	110	90	100			200	280	250	350	320	400 Rm	1050 Rm	550	630	400	550
Recommend	○	○	○	○	○	○	○	○	○	○	○	○	○	○	○	○	○	○	○	○	○

CARBIDE MODULAR HEAD, 3 FLUTE BALL NOSE (Center Match)

- Vollhartmetall, 3 Schneiden mit Stirnradius (Schneiden Mittelpunkt)
- CARBURE TÊTE MODULAIRE, 3 DENTS À BOUT HÉMISPHERIQUE (Coupe au Centre)
- TESTINA MODULARE IN MD, 3 TAGLIENTI, SEMISFERICA

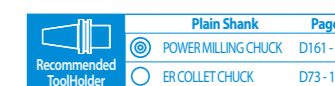
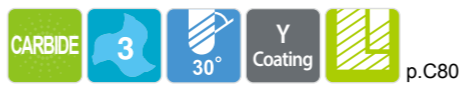
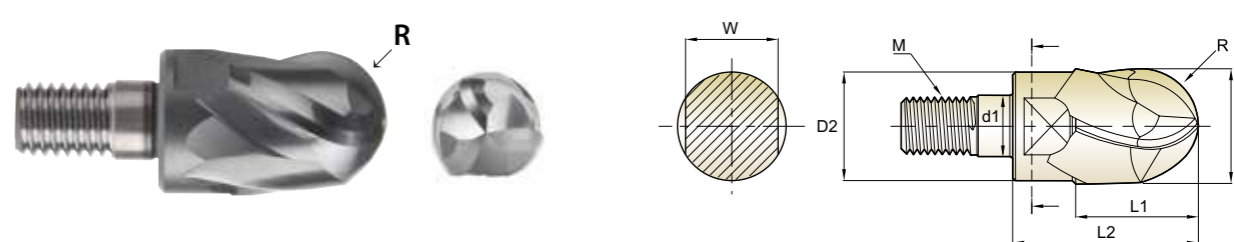

Unit : mm

EDP No.	Radius of Ball Nose	Mill Diameter	Neck Diameter	Length of Cut	Length Below Shank	Wrench Width	Coupling Diameter	Thread
Y-COATED	R	D1	D2	L1	L2	W	d1	M
XSEME59100	R5.0	10.0	9.2	10	17.5	8	6.5	M6
XSEME59120	R6.0	12.0	11.2	12	20.5	10	6.5	M6
XSEME59160	R8.0	16.0	15.0	16	25.5	13	8.5	M8
XSEME59200	R10.0	20.0	19.0	20	30.0	17	10.5	M10
XSEME59250	R12.5	25.0	24.0	25	37.0	22	12.5	M12
XSEME59300	R15.0	30.0	29.0	30	43.0	27	17.0	M16
XSEME59320	R16.0	32.0	31.0	32	45.0	27	17.0	M16

Radius Tolerance(mm)	Mill Dia. Tolerance(mm)
± 0.010	0 ~ - 0.02

◎ : Excellent ○ : Good

ISO	P										M					K					
	Non-alloy steel					Low alloy steel					High alloyed steel, and tool steel					Stainless steel		Grey cast iron		Nodular cast iron	Malleable cast iron
Material Description	1	2	3	4	5	6	7	8	9	10	11	12	13	14	15	16	17	18	19	20	
VDI 3323	1	2	3	4	5	6	7	8	9	10	11	12	13	14	15	16	17	18	19	20	
HRc	13	25	28	32	38	10	29	32	38	45	15	35	40	48	20	26	3	25	21	21	
HB	125	190	250	270	300	180	275	300	350	400	200	240	180	180	180	260	160	250	130	230	
Recommend	○	○	○	◎	◎	○	◎	◎	◎	◎	○	○	○	○	○	○	○	○	○	○	

ISO	N					S					H										
	Aluminum-wrought alloy		Aluminum-cast, alloyed		Copper and Copper Alloys (Bronze / Brass)	Non Metallic Materials		Heat Resistant Super Alloys					Titanium Alloys		Hardened steel	Chilled Cast Iron	Hardened Cast Iron				
Material Description	21	22	23	24	25	26	27	28	29	30	31	32	33	34	35	36	37	38	39	40	41
VDI 3323	21	22	23	24	25	26	27	28	29	30	31	32	33	34	35	36	37	38	39	40	41
HRc	21	22	23	24	25	26	27	28	29	30	31	32	33	34	35	36	37	38	39	40	41
HB	60	100	75	90	130	110	90	100			200	280	250	350	320	400 Rm	1050 Rm	550	630	400	550
Recommend	○	○	○	○	○	○	○	○	○	○	○	○	○	○	○	○	○	○	○	○	○



XSEME60 SERIES

CARBIDE MODULAR HEAD, 4 FLUTE BALL NOSE (Center Match)

- Vollhartmetall, 4 Schneiden mit Stirnradius (Schneiden Mittelpunkt)
- CARBURE TÊTE MODULAIRE, 4 DENTS À BOUT HÉMISPHERIQUE (Coupe au Centre)
- TESTINA MODULARE IN MD, 4 TAGLIENTI, SEMISFERICA

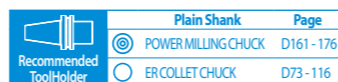
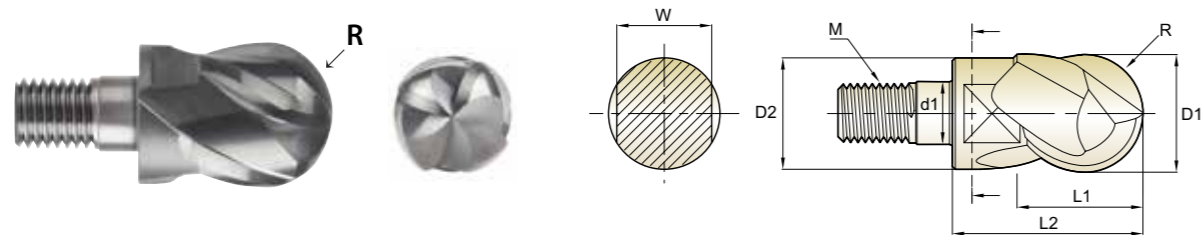

Unit : mm

EDP No.	Radius of Ball Nose	Mill Diameter	Neck Diameter	Length of Cut	Length Below Shank	Wrench Width	Coupling Diameter	Thread
Y-COATED	R	D1	D2	L1	L2	W	d1	M
XSEME60100	R5.0	10.0	9.2	10	17.5	8	6.5	M6
XSEME60120	R6.0	12.0	11.2	12	20.5	10	6.5	M6
XSEME60160	R8.0	16.0	15.0	16	25.5	13	8.5	M8
XSEME60200	R10.0	20.0	19.0	20	30.0	17	10.5	M10
XSEME60250	R12.5	25.0	24.0	25	37.0	22	12.5	M12
XSEME60300	R15.0	30.0	29.0	30	43.0	27	17.0	M16
XSEME60320	R16.0	32.0	31.0	32	45.0	27	17.0	M16

Radius Tolerance(mm)	Mill Dia. Tolerance(mm)
±0.010	0 ~ -0.02

◎ : Excellent ○ : Good

ISO Material Description	P										M				K					
	Non-alloy steel					Low alloy steel					High alloyed steel, and tool steel		Stainless steel		Grey cast iron		Nodular cast iron		Malleable cast iron	
VDI 3323	1	2	3	4	5	6	7	8	9	10	11	12	13	14	15	16	17	18	19	20
HRc	13	25	28	32	38	10	29	32	38	45	15	23	23	10	10	26	3	25	25	21
HB	125	190	250	270	300	180	275	300	350	200	200	240	180	180	180	260	160	250	130	230
Recommend	○	○	○	◎	◎	○	◎	◎	◎	◎	○	○	○	○	○	○	○	○	○	○

ISO Material Description	N										S				H								
	Aluminum-wrought alloy		Aluminum-cast, alloyed			Copper and Copper Alloys (Bronze / Brass)					Non Metallic Materials		Heat Resistant Super Alloys				Titanium Alloys		Hardened steel		Chilled Cast Iron		Hardened Cast Iron
VDI 3323	21	22	23	24	25	26	27	28	29	30	31	32	33	34	35	36	37	38	39	40	41		
HRc	21	22	23	24	25	26	27	28	29	30	31	32	33	34	35	36	37	38	39	40	41		
HB	60	100	75	90	130	110	90	100			200	280	250	350	320	400 Rm	1050 Rm	550	630	400	550		
Recommend	○	○	○	○	○	○	○	○	○	○	○	○	○	○	○	○	○	○	○	○	○		



XSEME01 SERIES

CARBIDE MODULAR HEAD, 4 FLUTE MULTIPLE HELIX CORNER RADIUS

- Vollhartmetall, 4 Schneiden mit M-Helix und Eckradius
- CARBURE TÊTE MODULAIRE, 4 DENTS TORIQUE, HÉLICE MULTIPLE
- TESTINA MODULARE IN MD, 4 TAGLIENTI, ELICA VARIABILE, TORICA

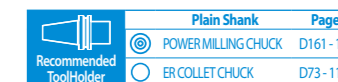
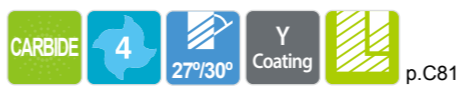
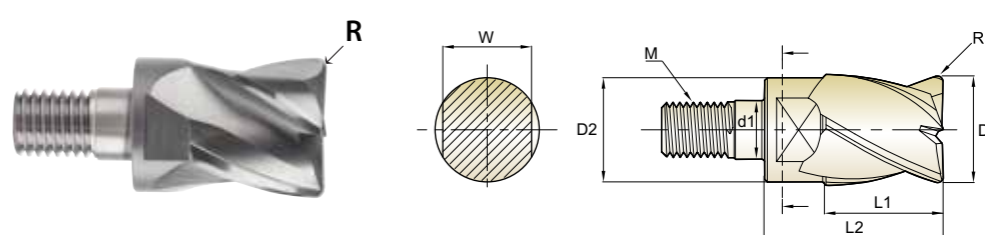

Unit : mm

EDP No.	Corner Radius	Mill Diameter	Neck Diameter	Length of Cut	Length Below Shank	Wrench Width	Coupling Diameter	Thread
Y-COATED	R	D1	D2	L1	L2	W	d1	M
XSEME01100 010	R0.1	10.0	9.2	10	17.5	8	6.5	M6
XSEME01100 020	R0.2	10.0	9.2	10	17.5	8	6.5	M6
XSEME01100 030	R0.3	10.0	9.2	10	17.5	8	6.5	M6
XSEME01100 050	R0.5	10.0	9.2	10	17.5	8	6.5	M6
XSEME01100 100	R1.0	10.0	9.2	10	17.5	8	6.5	M6
XSEME01100 150	R1.5	10.0	9.2	10	17.5	8	6.5	M6
XSEME01100 200	R2.0	10.0	9.2	10	17.5	8	6.5	M6
XSEME01100 250	R2.5	10.0	9.2	10	17.5	8	6.5	M6
XSEME01100 300	R3.0	10.0	9.2	10	17.5	8	6.5	M6
XSEME01100 400	R4.0	10.0	9.2	10	17.5	8	6.5	M6
XSEME01120 010	R0.1	12.0	11.2	12	20.5	10	6.5	M6
XSEME01120 020	R0.2	12.0	11.2	12	20.5	10	6.5	M6
XSEME01120 030	R0.3	12.0	11.2	12	20.5	10	6.5	M6
XSEME01120 050	R0.5	12.0	11.2	12	20.5	10	6.5	M6
XSEME01120 100	R1.0	12.0	11.2	12	20.5	10	6.5	M6
XSEME01120 150	R1.5	12.0	11.2	12	20.5	10	6.5	M6
XSEME01120 200	R2.0	12.0	11.2	12	20.5	10	6.5	M6
XSEME01120 250	R2.5	12.0	11.2	12	20.5	10	6.5	M6
XSEME01120 300	R3.0	12.0	11.2	12	20.5	10	6.5	M6
XSEME01120 400	R4.0	12.0	11.2	12	20.5	10	6.5	M6
XSEME01120 500	R5.0	12.0	11.2	12	20.5	10	6.5	M6
XSEME01160 050	R0.5	16.0	15.0	16	25.5	13	8.5	M8
XSEME01160 100	R1.0	16.0	15.0	16	25.5	13	8.5	M8
XSEME01160 150	R1.5	16.0	15.0	16	25.5	13	8.5	M8

Radius Tolerance(mm)	Mill Dia. Tolerance(mm)
±0.02	0 ~ -0.03

▶ NEXT PAGE

◎ : Excellent ○ : Good

ISO Material Description	P										M				K					
	Non-alloy steel					Low alloy steel					High alloyed steel, and tool steel		Stainless steel		Grey cast iron		Nodular cast iron		Malleable cast iron	
VDI 3323	1	2	3	4	5	6	7	8	9	10	11	12	13	14	15	16	17	18	19	20
HRc	13	25	28	32	38	10	29	32	38	45	15	23	23	10	10	26	3	25	25	21
HB	125	190	250	270	300	180	275	300	350	200	200	240	180	180	180	260	160	250	130	230
Recommend	○	○	○	◎	◎	○	◎	◎	◎	◎	○	○	○	○	○	○	○	○	○	○

ISO Material Description	N										S				H								
	Aluminum-wrought alloy		Aluminum-cast, alloyed			Copper and Copper Alloys (Bronze / Brass)					Non Metallic Materials		Heat Resistant Super Alloys				Titanium Alloys		Hardened steel		Chilled Cast Iron		Hardened Cast Iron
VDI 3323	21	22	23	24	25	26	27	28	29	30	31	32	33	34	35	36	37	38	39	40	41		
HRc	21	22	23	24	25	26	27	28	29	30	31	32	33	34	35	36	37	38	39	40	41		
HB	60	100	75	90	130	110	90	100			200	280	250	350	320	400 Rm	1050 Rm	550	630	400	550		
Recommend	○	○	○	○	○	○	○	○	○	○	○	○	○	○	○	○	○	○	○	○	○		



XSEME01 SERIES

CARBIDE MODULAR HEAD, 4 FLUTE MULTIPLE HELIX CORNER RADIUS

- Vollhartmetall, 4 Schneiden mit M-Helix und Eckradius
- CARBURE TÊTE MODULAIRE, 4 DENTS TORIQUE, HÉLICE MULTIPLE
- TESTINA MODULARE IN MD, 4 TAGLIENTI, ELICA VARIABILE, TORICA

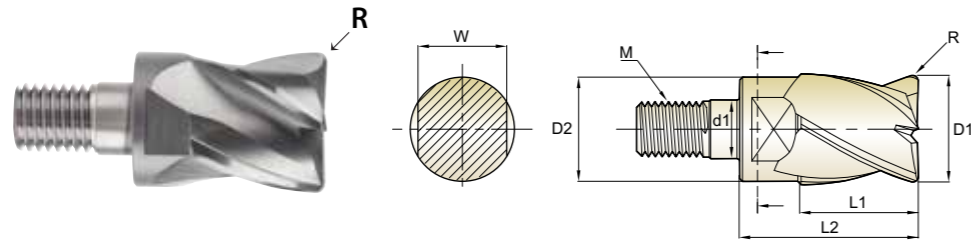

CARBIDE 4 27°/30° Coating Y p.C81

Plain Shank Page
 Recommended ToolHolder POWER MILLING CHUCK D161 - 176
 ER COLLET CHUCK D73 - 116

Unit : mm

EDP No.	Corner Radius	Mill Diameter	Neck Diameter	Length of Cut	Length Below Shank	Wrench Width	Coupling Diameter	Thread
Y-COATED	R	D1	D2	L1	L2	W	d1	M
XSEME01160 200	R2.0	16.0	15.0	16	25.5	13	8.5	M8
XSEME01200 050	R0.5	20.0	19.0	20	30.0	17	10.5	M10
XSEME01200 100	R1.0	20.0	19.0	20	30.0	17	10.5	M10
XSEME01200 150	R1.5	20.0	19.0	20	30.0	17	10.5	M10
XSEME01200 200	R2.0	20.0	19.0	20	30.0	17	10.5	M10
XSEME01250 050	R0.5	25.0	24.0	25	37.0	22	12.5	M12
XSEME01250 100	R1.0	25.0	24.0	25	37.0	22	12.5	M12
XSEME01250 150	R1.5	25.0	24.0	25	37.0	22	12.5	M12
XSEME01250 200	R2.0	25.0	24.0	25	37.0	22	12.5	M12
XSEME01300 050	R0.5	30.0	29.0	30	43.0	27	17.0	M16
XSEME01300 100	R1.0	30.0	29.0	30	43.0	27	17.0	M16
XSEME01300 150	R1.5	30.0	29.0	30	43.0	27	17.0	M16
XSEME01300 200	R2.0	30.0	29.0	30	43.0	27	17.0	M16
XSEME01320 050	R0.5	32.0	31.0	32	45.0	27	17.0	M16
XSEME01320 100	R1.0	32.0	31.0	32	45.0	27	17.0	M16
XSEME01320 150	R1.5	32.0	31.0	32	45.0	27	17.0	M16
XSEME01320 200	R2.0	32.0	31.0	32	45.0	27	17.0	M16

Radius Tolerance(mm)	Mill Dia. Tolerance(mm)
± 0.02	0 ~ - 0.03

◎ : Excellent ○ : Good

ISO Material Description	P										M				K					
	Non-alloy steel					Low alloy steel					High alloyed steel, and tool steel		Stainless steel		Grey cast iron	Nodular cast iron		Malleable cast iron		
VDI 3323	1	2	3	4	5	6	7	8	9	10	11	12	13	14	15	16	17	18	19	20
HRc	13	25	28	32	38	10	29	32	38	45	15	35	40	45	20	25	3	25	21	21
HB	125	190	250	270	300	180	275	300	350	200	325	200	240	180	180	260	160	250	130	230
Recommend	○	○	◎	◎	◎	○	◎	◎	◎	◎	◎	◎	◎	◎	○	○	○	○	○	○



XSEME68 SERIES

CARBIDE MODULAR HEAD, 6 FLUTE 45° HELIX CORNER RADIUS

- Vollhartmetall, 6 Schneiden mit 45° und Eckradius
- CARBURE TÊTE MODULAIRE, 6 DENTS TORIQUE, HÉLICE À 45°
- TESTINA MODULARE IN MD, 6 TAGLIENTI, ELICA 45°, TORICA

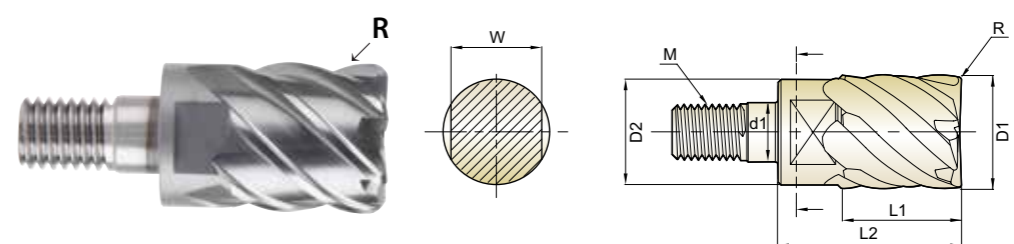

CARBIDE 6 45° Coating Y p.C82

Plain Shank Page
 Recommended ToolHolder POWER MILLING CHUCK D161 - 176
 ER COLLET CHUCK D73 - 116

Unit : mm

EDP No.	Corner Radius	Mill Diameter	Neck Diameter	Length of Cut	Length Below Shank	Wrench Width	Coupling Diameter	Thread
Y-COATED	R	D1	D2	L1	L2	W	d1	M
XSEME68100 030	R0.3	10.0	9.2	10	17.5	8	6.5	M6
XSEME68100 050	R0.5	10.0	9.2	10	17.5	8	6.5	M6
XSEME68100 100	R1.0	10.0	9.2	10	17.5	8	6.5	M6
XSEME68120 030	R0.3	12.0	11.2	12	20.5	10	6.5	M6
XSEME68120 050	R0.5	12.0	11.2	12	20.5	10	6.5	M6
XSEME68120 100	R1.0	12.0	11.2	12	20.5	10	6.5	M6
XSEME68160 050	R0.5	16.0	15.0	16	25.5	13	8.5	M8
XSEME68160 100	R1.0	16.0	15.0	16	25.5	13	8.5	M8
XSEME68160 150	R1.5	16.0	15.0	16	25.5	13	8.5	M8
XSEME68160 200	R2.0	16.0	15.0	16	25.5	13	8.5	M8
XSEME68200 050	R0.5	20.0	19.0	20	30.0	17	10.5	M10
XSEME68200 100	R1.0	20.0	19.0	20	30.0	17	10.5	M10
XSEME68200 150	R1.5	20.0	19.0	20	30.0	17	10.5	M10
XSEME68200 200	R2.0	20.0	19.0	20	30.0	17	10.5	M10
XSEME68250 050	R0.5	25.0	24.0	25	37.0	22	12.5	M12
XSEME68250 100	R1.0	25.0	24.0	25	37.0	22	12.5	M12
XSEME68250 150	R1.5	25.0	24.0	25	37.0	22	12.5	M12
XSEME68250 200	R2.0	25.0	24.0	25	37.0	22	12.5	M12
XSEME68300 050	R0.5	30.0	29.0	30	43.0	27	17.0	M16
XSEME68300 100	R1.0	30.0	29.0	30	43.0	27	17.0	M16
XSEME68300 150	R1.5	30.0	29.0	30	43.0	27	17.0	M16
XSEME68300 200	R2.0	30.0	29.0	30	43.0	27	17.0	M16
XSEME68320 050	R0.5	32.0	31.0	32	45.0	27	17.0	M16
XSEME68320 100	R1.0	32.0	31.0	32	45.0	27	17.0	M16
XSEME68320 150	R1.5	32.0	31.0	32	45.0	27	17.0	M16
XSEME68320 200	R2.0	32.0	31.0	32	45.0	27	17.0	M16

Radius Tolerance(mm)	Mill Dia. Tolerance(mm)
± 0.015	0 ~ - 0.03

◎ : Excellent ○ : Good

ISO Material Description	P										M				K					
	Non-alloy steel					Low alloy steel					High alloyed steel, and tool steel		Stainless steel		Grey cast iron	Nodular cast iron		Malleable cast iron		
VDI 3323	1	2	3	4	5	6	7	8	9	10	11	12	13	14	15	16	17	18	19	20
HRc	13	25	28	32	38	10	29	32	38	45	15	35	40	45	20	25	3	25	21	21
HB	125	190	250	270	300	180	275	300	350	200	325	200	240	180	180	260	160	250	130	230
Recommend	○	○	◎	◎	◎	○	◎	◎	◎	◎	◎	◎	◎	◎	○	○	○	○	○	○



XSEME36 SERIES

CARBIDE MODULAR HEAD, 4 FLUTE MULTIPLE HELIX

- Vollhartmetall, 4 Schneiden mit M-Helix
- CARBURE TÊTE MODULAIRE, 4 DENTS HÉLICE MULTIPLE
- TESTINA MODULARE IN MD, 4 TAGLIENTI, ELICA VARIABILE

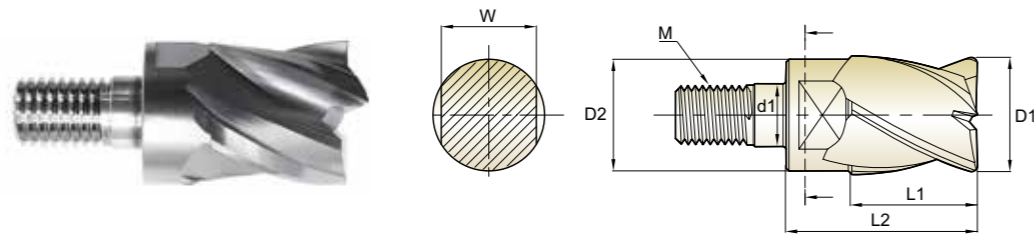

CARBIDE 4 27°/30° Coating Y p.C82

Plain Shank Page
 Recommended ToolHolder
 POWER MILLING CHUCK D161-176
 ER COLLET CHUCK D73-116

Unit : mm

EDP No.	Mill Diameter	Neck Diameter	Length of Cut	Length Below Shank	Wrench Width	Coupling Diameter	Thread
Y-COATED	D1	D2	L1	L2	W	d1	M
XSEME36100	10.0	9.2	10	17.5	8	6.5	M6
XSEME36120	12.0	11.2	12	20.5	10	6.5	M6
XSEME36160	16.0	15.0	16	25.5	13	8.5	M8
XSEME36200	20.0	19.0	20	30.0	17	10.5	M10
XSEME36250	25.0	24.0	25	37.0	22	12.5	M12
XSEME36300	30.0	29.0	30	43.0	27	17.0	M16
XSEME36320	32.0	31.0	32	45.0	27	17.0	M16

Mill Dia. Tolerance(mm)
0 ~ -0.03

◎ : Excellent ○ : Good

ISO Material Description	P										M				K					
	Non-alloy steel					Low alloy steel					High alloyed steel, and tool steel		Stainless steel		Grey cast iron		Nodular cast iron		Malleable cast iron	
VDI 3323	1	2	3	4	5	6	7	8	9	10	11	12	13	14	15	16	17	18	19	20
HRC	13	25	28	32	38	10	29	32	38	45	15	35	40	45	10	26	3	25	3	21
HB	125	190	250	270	300	180	275	300	350	400	200	240	180	180	180	260	160	250	130	230
Recommend	○	○	◎	◎	◎	○	◎	◎	◎	◎	○	○	○	○	○	○	○	○	○	○

ISO Material Description	N										S				H								
	Aluminum-wrought alloy		Aluminum-cast, alloyed			Copper and Copper Alloys (Bronze / Brass)					Non Metallic Materials		Heat Resistant Super Alloys				Titanium Alloys		Hardened steel		Chilled Cast Iron		Hardened Cast Iron
VDI 3323	21	22	23	24	25	26	27	28	29	30	31	32	33	34	35	36	37	38	39	40	41		
HRC	15	30	25	38	34						200	280	250	350	320	400 Rm	1050 Rm	550	630	400	550		
HB	60	100	75	90	130	110	90	100															
Recommend																							



XSEME75 SERIES

CARBIDE MODULAR HEAD, 6 FLUTE 45° HELIX

- Vollhartmetall, 6 Schneiden mit 45°
- CARBURE TÊTE MODULAIRE, 6 DENTS HÉLICE À 45°
- TESTINA MODULARE IN MD, 6 TAGLIENTI, ELICA 45°

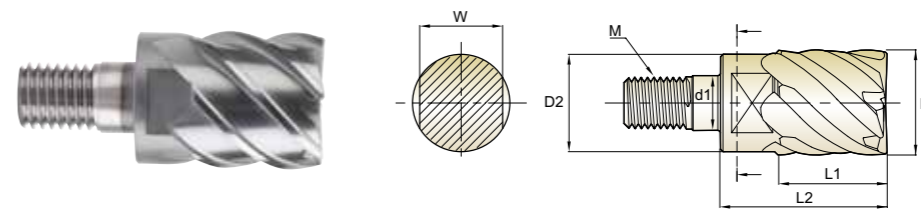

CARBIDE 6 45° Coating Y p.C83

Plain Shank Page
 Recommended ToolHolder
 POWER MILLING CHUCK D161-176
 ER COLLET CHUCK D73-116

Unit : mm

EDP No.	Mill Diameter	Neck Diameter	Length of Cut	Length Below Shank	Wrench Width	Coupling Diameter	Thread
Y-COATED	D1	D2	L1	L2	W	d1	M
XSEME75100	10.0	9.2	10	17.5	8	6.5	M6
XSEME75120	12.0	11.2	12	20.5	10	6.5	M6
XSEME75160	16.0	15.0	16	25.5	13	8.5	M8
XSEME75200	20.0	19.0	20	30.0	17	10.5	M10
XSEME75250	25.0	24.0	25	37.0	22	12.5	M12
XSEME75300	30.0	29.0	30	43.0	27	17.0	M16
XSEME75320	32.0	31.0	32	45.0	27	17.0	M16

Mill Dia. Tolerance(mm)
0 ~ -0.03

◎ : Excellent ○ : Good

ISO Material Description	P										M				K					
	Non-alloy steel					Low alloy steel					High alloyed steel, and tool steel		Stainless steel		Grey cast iron		Nodular cast iron		Malleable cast iron	
VDI 3323	1	2	3	4	5	6	7	8	9	10	11	12	13	14	15	16	17	18	19	20
HRC	13	25	28	32	38	10	29	32	38	45	15	35	40	45	10	26	3	25	3	21
HB	125	190	250	270	300	180	275	300	350	400	200	240	180	180	180	260	160	250	130	230
Recommend	○	○	◎	◎	◎	○	◎	◎	◎	◎	○	○	○	○	○	○	○	○	○	○

ISO Material Description	N										S				H								
	Aluminum-wrought alloy		Aluminum-cast, alloyed			Copper and Copper Alloys (Bronze / Brass)					Non Metallic Materials		Heat Resistant Super Alloys				Titanium Alloys		Hardened steel		Chilled Cast Iron		Hardened Cast Iron
VDI 3323	21	22	23	24	25	26	27	28	29	30	31	32	33	34	35	36	37	38	39	40	41		
HRC	15	30	25	38	34						200	280	250	350	320	400 Rm	1050 Rm	550	630	400	550		
HB	60	100	75	90	130	110	90	100															
Recommend																							

CARBIDE HOLDER - STRAIGHT NECK TYPE

- Vollhartmetallschaft - zylindrisch
- PORTE-OUTIL CARBURE - Entrée Droite
- STELO IN MD, SCARICO CILINDRICO

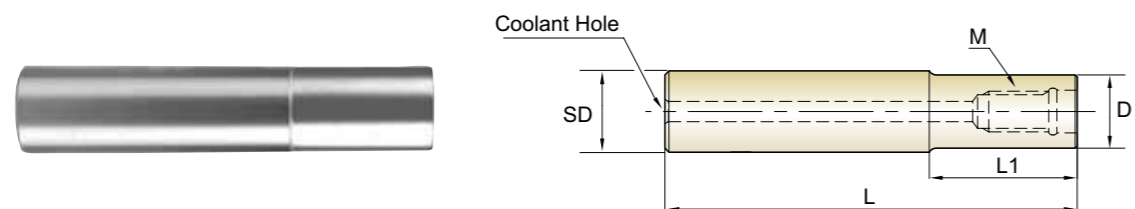

Unit : mm

EDP No.	Mill Diameter	Shank Diameter SD	Overall Length L	Neck Length L1	Neck Diameter D	Thread Size M	Wrench No.	Coolant Hole
ZMC1001100	10.0	10	70	20	9.5	M6	SPIS0810	2
ZMC1002100	10.0	10	100	40	9.5	M6	SPIS0810	2
ZMC1003100	10.0	10	130	70	9.5	M6	SPIS0810	2
ZMC1201120	12.0	12	80	20	11.5	M6	SPIS0810	2
ZMC1202120	12.0	12	100	40	11.5	M6	SPIS0810	2
ZMC1203120	12.0	12	130	70	11.5	M6	SPIS0810	2
ZMC1601160	16.0	16	100	40	15.5	M8	SPIS1300	3
ZMC1602160	16.0	16	150	80	15.5	M8	SPIS1300	3
ZMC1603160	16.0	16	200	120	15.5	M8	SPIS1300	3
ZMC2001200	20.0	20	100	40	19.5	M10	SPIS1700	4
ZMC2002200	20.0	20	150	80	19.5	M10	SPIS1700	4
ZMC2003200	20.0	20	200	120	19.5	M10	SPIS1700	4
ZMC2004200	20.0	20	250	160	19.5	M10	SPIS1700	4
ZMC2501250	25.0	25	150	70	24.3	M12	SPIS2200	5
ZMC2502250	25.0	25	200	100	24.3	M12	SPIS2200	5
ZMC2503250	25.0	25	250	150	24.3	M12	SPIS2200	5
ZMC2504250	25.0	25	300	200	24.3	M12	SPIS2200	5
ZMC3001320	30.0 / 32.0	32	150	70	29.0	M16	SPIS2700	6
ZMC3002320	30.0 / 32.0	32	200	120	29.0	M16	SPIS2700	6
ZMC3003320	30.0 / 32.0	32	250	150	29.0	M16	SPIS2700	6
ZMC3004320	30.0 / 32.0	32	300	200	29.0	M16	SPIS2700	6
ZMC3005320	30.0 / 32.0	32	350	250	29.0	M16	SPIS2700	6

- ▶The wrench (1pc) for the relevant item is included.
If more is needed, available for sale.
- ▶Please refer to the wrench table on the next page.

STEEL HOLDER - STRAIGHT NECK TYPE

- Stahlschaft - zylindrisch
- PORTE-OUTIL ACIER - Entrée Droite
- STELO IN ACCIAIO, SCARICO CILINDRICO

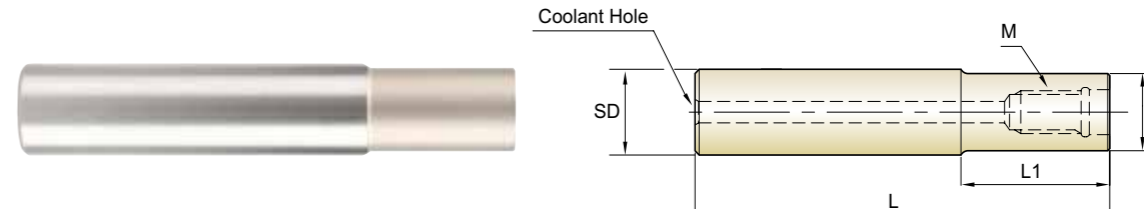

Unit : mm

EDP No.	Mill Diameter	Shank Diameter SD	Overall Length L	Neck Length L1	Neck Diameter D	Thread Size M	Wrench No.	Coolant Hole
ZMS1001100	10.0	10	70	20	9	M6	SPIS0810	3
ZMS1201120	12.0	12	90	30	11	M6	SPIS0810	3
ZMS1601160	16.0	16	100	30	15	M8	SPIS1300	4
ZMS2001200	20.0	20	100	30	19	M10	SPIS1700	5
ZMS2501250	25.0	25	115	40	24	M12	SPIS2200	5
ZMS3001320	30.0 / 32.0	32	125	40	29	M16	SPIS2700	6

- ▶The wrench (1pc) for the relevant item is included.
If more is needed, available for sale.

Wrench

Model	Wrench No.	Wrench Width	Mill Diameter	Clamping Torque [N·m]
	SPIS0810	8	10.0	6.5
		10	12.0	6.5
	SPIS1300	13	16.0	10
	SPIS1700	17	20.0	12
	SPIS2200	22	25.0	15
	SPIS2700	27	30.0 / 32.0	20

STEEL HOLDER - TAPER NECK TYPE

- **Stahlschaft - konisch**
- **PORTE-OUTIL ACIER - Entrée Conique**
- **STELO IN ACCIAIO, SCARICO CONICO**

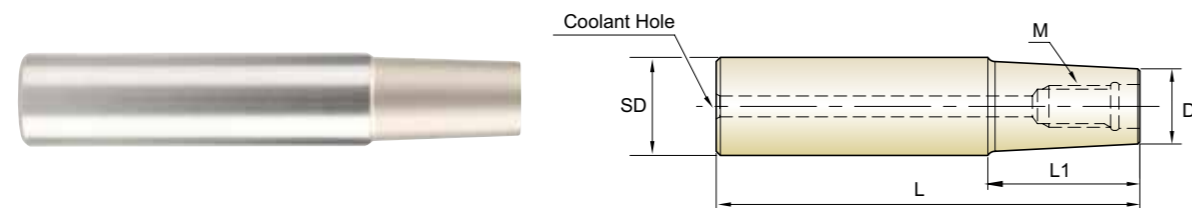

Unit : mm

EDP No.	Mill Diameter	Shank Diameter	Overall Length	Neck Length	Neck Diameter	Thread Size	Wrench No.	Coolant Hole
		SD	L	L1	D	M		
ZMT1001120	10.0	12	100	50	9	M6	SPIS0810	3
ZMT1201160	12.0	16	130	70	11	M6	SPIS0810	3
ZMT1601200	16.0	20	150	90	15	M8	SPIS1300	4
ZMT2001250	20.0	25	170	100	19	M10	SPIS1700	5
ZMT2501320	25.0	32	200	110	24	M12	SPIS2200	5
ZMT3001320	30.0 / 32.0	32	200	110	29	M16	SPIS2700	6

►The wrench(1pc) for the relevant item is included.
If more is needed, available for sale.

Wrench

Model	Wrench No.	Wrench Width	Mill Diameter	Clamping Torque [N·m]
	SPIS0810	8	10.0	6.5
		10	12.0	6.5
	SPIS1300	13	16.0	10
		17	20.0	12
	SPIS2200	22	25.0	15
		27	30.0 / 32.0	20

Instruction Manual
BEDIENUNGSAMLEITUNG

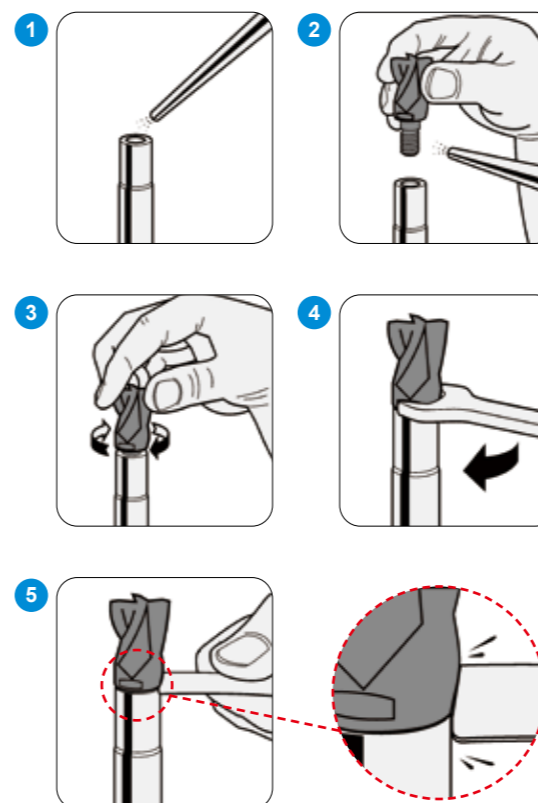

Step 1, 2 : Clean

Please be sure to remove dirt and debris on all adjoining surfaces before assembling. (air preferred)

Schritt 1, 2: Reinigen

Achten Sie darauf, Schmutz und Verunreinigungen an allen angrenzenden Flächen vor dem Zusammenbau zu entfernen. (bevorzugt durch Luft)

Step 3, 4 : Assembly

Mount the modular head onto the shank by hand until it fits then use the supplied wrench to tighten.

Schritt 3, 4: Zusammenbau

Montieren Sie den modularen Kopf von Hand auf den Schaft, bis er passt. Benutzen Sie dann den mitgelieferten Schraubenschlüssel.

Step 5 : Final Check

Re-check that there is no gap.

Schritt 5, 6: Endkontrolle

Überprüfen Sie, dass es kein mehr Spalt sichtbar ist.

Notice

Please tighten the screw with designated torque, too much torque will damage the screw.

Achtung

Ziehen Sie die Schraube mit dem vorgesehenen Drehmoment an, zu viel Drehmoment wird die Schraube beschädigen.

Mill Diameter (D)	Clamping Torque [N·m]
10.0	6.5
12.0	6.5
16.0	10.0
20.0	12.0
25.0	15.0
30.0	20.0
32.0	20.0



RECOMMENDED CUTTING CONDITIONS
EMPFOHLENE SCHNEIDPARAMETER

XSEMD98 SERIES 2 FLUTE BALL NOSE

Vc = m/min.
fz = mm/tooth
RPM = rev./min.
FEED = mm/min.

ISO	VDI 3323	Material Description	Ae	Ap	Parameter	Diameter (Ø)								
						10	12	16	20	25	30	32		
P	1-8	Non-alloy steel	0.08D	0.03D	Vc	175	170	168	168	167	167	167		
					fz	0.199	0.212	0.238	0.264	0.270	0.299	0.300		
	9	Low alloy steel	0.08D	0.03D	RPM	5580	4510	3340	2670	2130	1770	1660		
					FEED	2220	1910	1590	1410	1150	1060	995		
	H	10-11.1	High alloyed steel, and tool steel	0.08D	0.03D	Vc	168	165	162	162	162	162	162	
						fz	0.174	0.188	0.206	0.227	0.231	0.250	0.250	
		11.2	High alloyed steel, and tool steel	0.08D	0.03D	RPM	5340	4380	3220	2580	2060	1720	1610	
						FEED	1860	1645	1320	1170	950	860	805	
		K	15-20	Grey cast iron Nodular cast iron Malleable cast iron	0.08D	0.03D	Vc	175	170	168	168	167	167	167
							fz	0.199	0.212	0.238	0.264	0.270	0.299	0.300
			38.1 - 38.2	Hardened steel	0.08D	0.03D	RPM	5580	4510	3340	2670	2130	1770	1660
							FEED	2220	1910	1590	1410	1150	1060	995
H			40	Chilled Cast Iron	0.08D	0.03D	Vc	141	138	136	136	136	136	136
							fz	0.160	0.170	0.189	0.208	0.211	0.229	0.230
			41	Hardened Cast Iron	0.08D	0.03D	RPM	4500	3660	2700	2160	1730	1440	1350
							FEED	1440	1245	1020	900	730	660	620

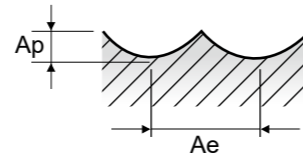

XSEME59 SERIES 3 FLUTE BALL NOSE

ISO	VDI 3323	Material Description	Ae	Ap	Parameter	Diameter (Ø)								
						10	12	16	20	25	30	32		
P	1-8	Non-alloy steel	0.05D	0.02D	Vc	307	307	307	307	307	307	307		
					fz	0.201	0.225	0.234	0.238	0.248	0.259	0.268		
	9	Low alloy steel	0.05D	0.02D	RPM	9770	8150	6100	4880	3910	3260	3050		
					FEED	5890	5490	4280	3490	2910	2530	2450		
	H	10-11.1	High alloyed steel, and tool steel	0.05D	0.02D	Vc	257	257	257	257	257	257	257	
						fz	0.168	0.187	0.199	0.209	0.219	0.230	0.234	
		11.2	High alloyed steel, and tool steel	0.05D	0.02D	RPM	8190	6830	5110	4090	3270	2730	2560	
						FEED	4130	3830	3050	2560	2150	1880	1800	
		K	15-20	Grey cast iron Nodular cast iron Malleable cast iron	0.05D	0.02D	Vc	307	307	307	307	307	307	307
							fz	0.201	0.225	0.234	0.238	0.248	0.259	0.268
			38.1 - 38.2	Hardened steel	0.05D	0.02D	RPM	9770	8150	6100	4880	3910	3260	3050
							FEED	5890	5490	4280	3490	2910	2530	2450
H			40	Chilled Cast Iron	0.05D	0.02D	Vc	208	208	208	208	208	208	208
							fz	0.156	0.173	0.180	0.190	0.200	0.210	0.221
			41	Hardened Cast Iron	0.05D	0.02D	RPM	6620	5520	4140	3310	2650	2210	2070
							FEED	3100	2870	2240	1890	1590	1390	1370

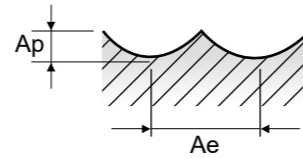

RECOMMENDED CUTTING CONDITIONS
EMPFOHLENE SCHNEIDPARAMETER

XSEME60 SERIES 4 FLUTE BALL NOSE

Vc = m/min.
fz = mm/tooth
RPM = rev./min.
FEED = mm/min.

ISO	VDI 3323	Material Description	Ae	Ap	Parameter	Diameter (Ø)								
						10	12	16	20	25	30	32		
P	1-8	Non-alloy steel	0.05D	0.02D	Vc	341	341	341	341	341	341	341		
					fz	0.148	0.165	0.175	0.179	0.186	0.194	0.201		
	9	Low alloy steel	0.05D	0.02D	RPM	10850	9050	6780	5430	4340	3620	3390		
					FEED	6430	5960	4750	3880	3230	2810	2720		
	H	10-11.1	High alloyed steel, and tool steel	0.05D	0.02D	Vc	286	286	286	286	286	286	286	
						fz	0.126	0.140	0.149	0.156	0.164	0.172	0.176	
		11.2	High alloyed steel, and tool steel	0.05D	0.02D	RPM	9100	7500	5680	4550	3640	3030	2840	
						FEED	4590	4260	3390	2840	2390	2090	2000	
		K	15-20	Grey cast iron Nodular cast iron Malleable cast iron	0.05D	0.02D	Vc	341	341	341	341	341	341	341
							fz	0.148	0.165	0.175	0.179	0.186	0.194	0.201
			38.1 - 38.2	Hardened steel	0.05D	0.02D	RPM	10850	9050	6780	5430	4340	3620	3390
							FEED	6430	5960	4750	3880	3230	2810	2720
H			40	Chilled Cast Iron	0.05D	0.02D	Vc	231	231	231	231	231	231	231
							fz	0.117	0.130	0.135	0.143	0.150	0.157	0.165
			41	Hardened Cast Iron	0.05D	0.02D	RPM	7350	6130	4600	3680	2940	2450	2300
							FEED	3450	3190	2490	2100	1760	1540	1520

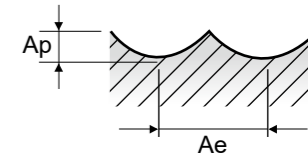

XSEME01 SERIES 4 FLUTE CORNER RADIUS - SIDE CUTTING

ISO	VDI 3323	Material Description	Ae	Ap	Parameter	Diameter (Ø)								
						10	12	16	20	25	30	32		
P	1-8	Non-alloy steel	0.05D	0.8D	Vc	156	156	156	156	156	156	156		
					fz	0.023	0.023	0.023	0.023	0.023	0.023	0.023		
	9	Low alloy steel	0.05D	0.8D	RPM	4970	4140	3100	2480	1990	1650	1550		
					FEED	455	380	280	230	180	150	140		
	H	10-11.1	High alloyed steel, and tool steel	0.05D	0.8D	Vc	105	105	105	105	105	105	105	
						fz	0.027	0.027	0.027	0.027	0.027	0.027	0.026	
		11.2	High alloyed steel, and tool steel	0.05D	0.8D	RPM	3340	2780	2090	1670	1340	1110	1040	
						FEED	360	300	225	180	145	120	110	
		K	15-20	Grey cast iron Nodular cast iron Malleable cast iron	0.02D	0.8D	Vc	156	156	156	156	156	156	156
							fz	0.023	0.023	0.023	0.023	0.023	0.023	0.023
			38.1 - 38.2	Hardened steel	0.02D	0.8D	RPM	4960	4140	3100	2480	1990	1650	1550
							FEED	460	380	280	230	180	150	140
H			40	Chilled Cast Iron	0.05D	0.8D	Vc	63	63	63	63	63	63	63
							fz	0.021	0.021	0.022	0.023	0.023	0.024	0.024
			41	Hardened Cast Iron	0.02D	0.8D	RPM	2020	1680	1250	1000	800	670	630
							FEED	170	140	110	90	75	65	60

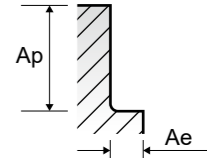



RECOMMENDED CUTTING CONDITIONS
EMPFOHLENE SCHNEIDPARAMETER



RECOMMENDED CUTTING CONDITIONS
EMPFOHLENE SCHNEIDPARAMETER

XSEME68 SERIES 6 FLUTE CORNER RADIUS - SIDE CUTTING

Vc = m/min.
fz = mm/tooth
RPM = rev./min.
FEED = mm/min.

ISO	VDI 3323	Material Description	Ae	Ap	Parameter	Diameter (Ø)							
						10	12	16	20	25	30	32	
P	1-8	Non-alloy steel	0.05D	1.0D	Vc	302	302	302	302	302	302	302	
		Low alloy steel			fz	0.051	0.058	0.067	0.070	0.070	0.075	0.075	
	9	High alloyed steel, and tool steel	0.05D	1.0D	RPM	9600	8010	6000	4800	3850	3200	3000	
					FEED	2940	2790	2400	2010	1615	1440	1350	
	10-11.1	High alloyed steel, and tool steel	0.05D	1.0D	Vc	294	294	294	294	294	294	294	
					fz	0.025	0.025	0.025	0.025	0.027	0.029	0.030	
	11.2	High alloyed steel, and tool steel	0.05D	1.0D	RPM	9360	7800	5850	4680	3740	3120	2920	
					FEED	1400	1170	880	690	600	540	525	
	K	15-20	Grey cast iron Nodular cast iron Malleable cast iron	0.05D	1.0D	Vc	302	302	302	302	302	302	302
			fz			0.051	0.058	0.067	0.070	0.075	0.075	0.075	
	H	38.1 - 38.2	Hardened steel	0.02D	1.0D	RPM	9600	8010	6000	4800	3850	3200	3000
						FEED	2940	2790	2400	2010	1615	1440	1350
H	40	Chilled Cast Iron	0.05D	1.0D	Vc	181	181	181	181	181	181	181	
					fz	0.006	0.006	0.006	0.006	0.007	0.007	0.007	
H	41	Hardened Cast Iron	0.02D	1.0D	RPM	5760	4800	3600	2880	2305	1920	1800	
					FEED	210	180	130	110	90	85	80	

XSEME75 SERIES 6 FLUTE - SIDE CUTTING

Vc = m/min.
fz = mm/tooth
RPM = rev./min.
FEED = mm/min.

NORMAL SPEED

ISO	VDI 3323	Material Description	Ae	Ap	Parameter	Diameter (Ø)							
						10	12	16	20	25	30	32	
P	1-8	Non-alloy steel	0.1D	0.8D	Vc	111	111	111	111	111	111	111	
		Low alloy steel			fz	0.099	0.099	0.100	0.100	0.100	0.100	0.100	
	9	High alloyed steel, and tool steel	0.05D	0.8D	RPM	3530	2945	2205	1765	1410	1180	1100	
					FEED	2100	1750	1325	1060	845	710	660	
	10-11.1	High alloyed steel, and tool steel	0.1D	0.8D	Vc	77	77	77	77	77	77	77	
					fz	0.094	0.094	0.094	0.094	0.094	0.094	0.094	
	11.2	High alloyed steel, and tool steel	0.05D	0.8D	RPM	2450	2040	1530	1220	980	815	765	
					FEED	1380	1150	860	690	555	460	430	
	K	15-20	Grey cast iron Nodular cast iron Malleable cast iron	0.1D	0.8D	Vc	111	111	111	111	111	111	111
			fz			0.099	0.099	0.100	0.100	0.100	0.100	0.100	
	H	38.1 - 38.2	Hardened steel	0.05D	0.6D	RPM	3530	2940	2205	1765	1410	1180	1100
						FEED	2100	1750	1325	1060	845	710	660
H	40	Chilled Cast Iron	0.05D	0.8D	Vc	33	33	33	33	33	33	33	
					fz	0.033	0.034	0.034	0.035	0.035	0.036	0.036	
H	41	Hardened Cast Iron	0.05D	0.6D	RPM	1050	880	655	525	420	350	330	
					FEED	210	180	130	110	85	75	70	

XSEME36 SERIES 4 FLUTE - SIDE CUTTING

Vc = m/min.
fz = mm/tooth
RPM = rev./min.
FEED = mm/min.

ISO	VDI 3323	Material Description	Ae	Ap	Parameter	Diameter (Ø)							
						10	12	16	20	25	30	32	
P	1-8	Non-alloy steel	0.05D	0.6D	Vc	128	129	130	132	134	134	134	
		Low alloy steel			fz	0.040	0.040	0.040	0.040	0.040	0.040	0.040	
	9	High alloyed steel, and tool steel	0.05D	0.6D	RPM	4080	3430	2590	2100	1700	1420	1330	
					FEED	650	545	415	335	270	230	215	
	10-11.1	High alloyed steel, and tool steel	0.05D	0.6D	Vc	79	79	80	82	82	82	82	
					fz	0.030	0.030	0.030	0.030	0.031	0.032	0.032	
	11.2	High alloyed steel, and tool steel	0.05D	0.6D	RPM	2500	2100	1590	1300	1050	870	820	
					FEED	300	250	190	155	130	110	105	
	M	12-14	Stainless steel	0.05D	0.6D	Vc	66	66	66	66	67	67	67
						fz	0.035	0.035	0.035	0.035	0.035	0.035	0.035
	K	15-20	Grey cast iron Nodular cast iron Malleable cast iron	0.05D	0.6D	RPM	2100	1750	1310	1050	850	710	670
			FEED			300	245	180	150	120	100	95	
H	38.1 - 38.2	Hardened steel	0.05D	0.6D	Vc	128	129	130	132	134	134	134	
					fz	0.039	0.040	0.040	0.040	0.040	0.040	0.040	
H	40	Chilled Cast Iron	0.05D	0.6D	RPM	4080	3430	2590	2100	1700	1420	1330	
					FEED	640	545	415	335	270	230	215	
H	41	Hardened Cast Iron	0.05D	0.6D	Vc	53	53	53	53	53	53	53	
					fz	0.013	0.013	0.013	0.012	0.011	0.011	0.011	

HIGH SPEED

Vc = m/min.
fz = mm/tooth
RPM = rev./min.
FEED = mm/min.

ISO	VDI 3323	Material Description	Ae	Ap	Parameter	Diameter (Ø)						
						10	12	16	20	25	30	32
P	11.2	High alloyed steel, and tool steel	0.05D	0.6D	Vc	332	332	332	332	332	332	332
					fz	0.095	0.095	0.095	0.095	0.095	0.095	0.095
H	38.1 - 38.2	Hardened steel	0.05D	0.4D	RPM	10570	8810	6600	5290	4230	3520	3300
					FEED	6020	5020	3765	3050	2400	2000	1890
H	40	Chilled Cast Iron	0.05D	0.6D	Vc	166	166	166	166	166	166	166
					fz	0.096	0.095	0.095	0.095	0.095	0.095	0.095
H	41	Hardened Cast Iron	0.05D	0.4D	RPM	5290	4410	3300	2645	2114	1761	1651
					FEED	3050	2520	1880	1470	1200	1000	940

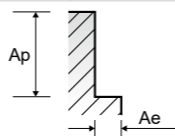
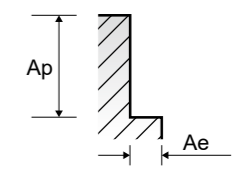
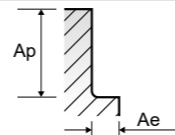



Global Cutting Tool Leader **YG-1**



MILLING



Leading Through Innovation



SOLID CARBIDE

X5070 END MILLS

X5070 NANO-VHM - FRÄSER

- For High Hardened Steels (HRc45 to HRc70)
High Speed Machining and Dry Cutting
- Für hochgehärtete Stähle (HRc45 bis HRc70)
Hochgeschwindigkeitsbearbeitung und Trockenbearbeitung

SELECTION GUIDE



SOLID CARBIDE
X5070
END MILLS

High Hardened Steels HRc45 to HRc70,
High Speed Machining, Dry Cutting

Please visit
globalyg1.com/mat
for material search

◎ : Excellent ○ : Good

Recommended cutting conditions : p. C123

SERIES	G8B59	G8B54	G8A46	G8A54
FLUTE	4	4	2	2
HELIX ANGLE	0°	0°	30°	30°
CUTTING EDGE SHAPE	CORNER RADIUS	CORNER RADIUS	BALL NOSE	BALL NOSE
SIZE MIN	D2.0	D2.0	R0.05	R0.25
SIZE MAX	D12.0	D16.0	R2.0	R1.0
PAGE	C89	C90	C91	C95
	HIGH FEED	HIGH FEED LONG SHANK	RIB PROCESSING	RIB PROCESSING
	Blue Coating	Blue Coating	Blue Coating	Blue Coating



ISO	VDI 3323	Material Description	Composition / Structure / Heat Treatment	HB	HRc	G8B59	G8B54	G8A46	G8A54
P	1	Non-alloy steel	About 0.15% C Annealed	125					
	2		About 0.45% C Annealed	190	13				
	3		About 0.45% C Quenched & Tempered	250	25				
	4		About 0.75% C Annealed	270	28				
	5	About 0.75% C Quenched & Tempered	300	32	○	○	○	○	
	6	Low alloy steel	Annealed	180	10				
	7		Quenched & Tempered	275	29				
	8		Quenched & Tempered	300	32	○	○	○	○
	9		Quenched & Tempered	350	38	○	○	○	○
	10		High alloyed steel, and tool steel	Annealed	200	15			
	11	Quenched & Tempered		325	35	○	○	○	○
M	12	Stainless steel	Ferritic / Martensitic Annealed	200	15				
	13		Martensitic Quenched & Tempered	240	23				
	14		Austenitic	180	10				
K	15	Grey cast iron	Pearlitic / ferritic	180	10				
	16		Pearlitic (Martensitic)	260	26				
	17	Nodular cast iron	Ferritic	160	3				
	18		Pearlitic	250	25				
	19		Ferritic	130					
20	Malleable cast iron	Pearlitic	230	21					
N	21	Aluminum-wrought alloy	Not Curable	60					
	22		Curable Hardened	100					
	23	Aluminum-cast, alloyed	≤ 12% Si, Not Curable	75					
	24		≤ 12% Si, Curable Hardened	90					
	25		> 12% Si, Not Curable	130					
	26	Copper and Copper Alloys (PB>1%)	CuZn, CuSnZn (Brass)	110					
	27	Copper Alloys (Bronze / Brass)	CuSn, lead-free copper and electrolytic copper	100					
	28								
	29	Non Metallic Materials	Duroplastic, Fiber Reinforced Plastic						
30	Rubber, Wood, etc.								
S	31	Heat Resistant Super Alloys	Fe Based Annealed	200	15				
	32		Cured	280	30				
	33		Annealed	250	25				
	34		Ni or Co Based Cured	350	38				
	35		Cast	320	34				
	36	Titanium Alloys	Pure Titanium	400 Rm					
	37		Alpha + Beta Alloys Hardened	1050 Rm					
H	38	Hardened steel	Hardened	550	55	◎	◎	◎	◎
	39		Hardened	630	60	◎	◎	◎	◎
	40	Chilled Cast Iron	Cast	400	42	○	○	○	○
	41	Hardened Cast Iron	Hardened	550	55	◎	◎	◎	◎

G8A28	G8A38	G8A53	G8A59	G8D62	G8A60	G8A36	G8A52	G8A50	G8A47	G8A37	G8B08	G8A39
2	2	2	3	4	2	2	2	2	4	4	4	6
30°	30°	30°	30°	30°	30°	30°	30°	30°	30°	30°	30°	45°
BALL NOSE	BALL NOSE	BALL NOSE	BALL NOSE	BALL NOSE	CORNER RADIUS	CORNER RADIUS	CORNER RADIUS	CORNER RADIUS	CORNER RADIUS	CORNER RADIUS	CORNER RADIUS	CORNER RADIUS
R0.05	R0.5	R0.2	R1.5	R1.5	D0.5	D0.3	D0.5	D0.3	D3.0	D1.0	D6.0	D6.0
R6.0	R12.5	115	R10.0	R10.0	D12.0	D20.0	D2.0	D2.0	D12.0	D20.0	D12.0	D20.0
C96	C98	C99	C100	C101	C102	C107	C109	C110	C111	C112	C113	C114
-	EXTENDED NECK	MINIATURE	Center Match	Center Match	RIB PROCESSING	EXTENDED NECK	RIB PROCESSING	MINIATURE	EXTENDED NECK	EXTENDED NECK	EXTENDED NECK	EXTENDED NECK
Blue Coating	Blue Coating	Blue Coating	Blue Coating	Blue Coating	Blue Coating	Blue Coating	Blue Coating	Blue Coating	Blue Coating	Blue Coating	Blue Coating	Blue Coating



													1
													2
													3
													4
○	○	○	○	○	○	○	○	○	○	○	○	○	5
													6
													7
○	○	○	○	○	○	○	○	○	○	○	○	○	8
○	○	○	○	○	○	○	○	○	○	○	○	○	9
													10
○	○	○	○	○	○	○	○	○	○	○	○	○	11
													12
													13
													14
													15
													16
													17
													18
													19
													20
													21
													22
													23
													24
													25
													26
													27
													28
													29
													30
													31
													32
													33
													34
													35
													36
													37
◎	◎	◎	◎	◎	◎	◎	◎	◎	◎	◎	◎	◎	38
◎	◎	◎	◎	◎	◎	◎	◎	◎	◎	◎	◎	◎	39
○	○	○	○	○	○	○	○	○	○	○	○	○	40
◎	◎	◎	◎	◎	◎	◎	◎	◎	◎	◎	◎	◎	41

SELECTION GUIDE



SERIES	G8A45	G8A01	G8A02	G8D63	G8D64
FLUTE	2	2	4	6&8	6&8
HELIX ANGLE	30°	30°	30°	45°	45°
CUTTING EDGE SHAPE	SQUARE	SQUARE	SQUARE	SQUARE	SQUARE
SIZE MIN	D0.1	D0.1	D1.0	D6.0	D6.0
SIZE MAX	D4.0	D20.0	D20.0	D25.0	D25.0
PAGE	C115	C119	C120	C121	C122
RIB PROCESSING	Blue Coating	Blue Coating	Blue Coating	Blue Coating	Blue Coating
EXTENDED NECK					
LONG LENGTH					
EXTRA LONG LENGTH					

SOLID CARBIDE
X5070
END MILLS

High Hardened Steels HRc45 to HRc70,
High Speed Machining, Dry Cutting



Please visit globalyg1.com/mat for material search

◎ : Excellent ○ : Good

Recommended cutting conditions : p. C123

ISO	VDI 3323	Material Description	Composition / Structure / Heat Treatment	HB	HRc					
P	1	Non-alloy steel	About 0.15% C	Annealed	125					
	2		About 0.45% C	Annealed	190					
	3		About 0.45% C	Quenched & Tempered	250					
	4		About 0.75% C	Annealed	270					
	5		About 0.75% C	Quenched & Tempered	300	○	○	○	○	○
	6	Low alloy steel		Annealed	180					
	7			Quenched & Tempered	275					
	8			Quenched & Tempered	300	○	○	○	○	○
	9			Quenched & Tempered	350	○	○	○	○	○
	10			Quenched & Tempered	325	○	○	○	○	○
	M	11	High alloyed steel, and tool steel		Annealed	200				
12				Quenched & Tempered	325	○	○	○	○	
K		13	Stainless steel	Ferritic / Martensitic	Annealed	200				
		14		Martensitic	Quenched & Tempered	240				
K	15	Grey cast iron	Pearlitic / ferritic		180					
	16		Pearlitic (Martensitic)		260					
	17	Nodular cast iron	Ferritic		160					
	18		Pearlitic		250					
	19		Ferritic		130					
	20	Malleable cast iron	Pearlitic		230					
N	21	Aluminum-wrought alloy		Not Curable	60					
	22			Curable	Hardened	100				
	23	Aluminum-cast, alloyed		≤ 12% Si, Not Curable	75					
	24			≤ 12% Si, Curable	Hardened	90				
	25			> 12% Si, Not Curable		130				
	26			Cutting Alloys, PB>1%		110				
	27			CuZn, CuSnZn (Brass)		90				
	28			CuSn, lead-free copper and electrolytic copper		100				
	29		Non Metallic Materials		Duroplastic, Fiber Reinforced Plastic					
	30				Rubber, Wood, etc.					
S	31	Heat Resistant Super Alloys	Fe Based	Annealed	200					
	32			Cured	280					
	33			Annealed	250					
	34		Ni or Co Based	Cured	350					
	35			Cast	320					
	36			Pure Titanium	400 Rm					
37	Alpha + Beta Alloys	Hardened	1050 Rm							
H	38	Hardened steel		Hardened	550	◎	◎	◎	◎	
	39			Hardened	630	◎	◎	◎	◎	
	40	Chilled Cast Iron		Cast	400	○	○	○	○	
	41	Hardened Cast Iron		Hardened	550	◎	◎	◎	◎	



PLAIN SHANK **G8B59** SERIES

CARBIDE, 4 FLUTE STUB LENGTH CORNER RADIUS HIGH FEED

● VOLLHARTMETALL, 4 SCHNEIDEN EXTER KURZ ECKENRADIUS HOCHVORSCHUB
○ Fraise carbure, 4 dents, torique, grande avance, extra-courte
○ 4 TAGLIENTI, TORICA

- ▶ Excellent wear resistance at heavy feed rates on high hardened material.
- ▶ Designed with reduced clearance angles and short flutes for strength.
- ▶ High hardness & heat resistance coating for long life in dry applications.

- ▶ Hervorragende Verschleißigenschaften bei hohen Schnittwerten in gehärteten Materialien
- ▶ Mit reduzierten Freiwinkeln und kurzen Spannuten für hohe Festigkeiten konstruiert.
- ▶ Große Härte u. hitzebeständige Beschichtung für lange Lebensdauer bei Trockenbearbeitung



Plain Shank	Page
HYDRAULIC CHUCK SHRINK FIT HOLDER	D15-46 D47-72
POWER MILLING CHUCK	D161-176
ER COLLET CHUCK SK SLIM CHUCK	D73-116 D183-201

EDP No.	Corner Radius	Mill Diameter	Shank Diameter	Length of Cut	Length Below Shank	Overall Length	Neck Diameter
	R (±0.005)	D1	D2	L1	L3	L2	D3
G8B5902005	R0.5	2.0	6	1	6	50	1.8
G8B5903005	R0.5	3.0	6	1.2	8	50	2.8
G8B5904005	R0.5	4.0	6	1.5	10	50	3.8
G8B5906005	R0.5	6.0	6	2.5	12	60	5.4
G8B5906010	R1.0	6.0	6	2.5	12	60	5.4
G8B5908010	R1.0	8.0	8	3.5	16	60	7.2
G8B5908020	R2.0	8.0	8	3.5	16	60	7.2
G8B5910010	R1.0	10.0	10	4	20	70	9
G8B5910020	R2.0	10.0	10	4	20	70	9
G8B5912020	R2.0	12.0	12	5	25	80	11
G8B5912030	R3.0	12.0	12	5	25	80	11

Mill Dia. Tolerance (mm)	Corner Radius Tolerance (mm)	Shank Dia. Tolerance
0 ~ -0.02	± 0.005	h5

Due to the characteristics of the blue decoration layer, it might be erased during short term use and the color layer might not be uniformed. However, it doesn't affect the performance of the tool.

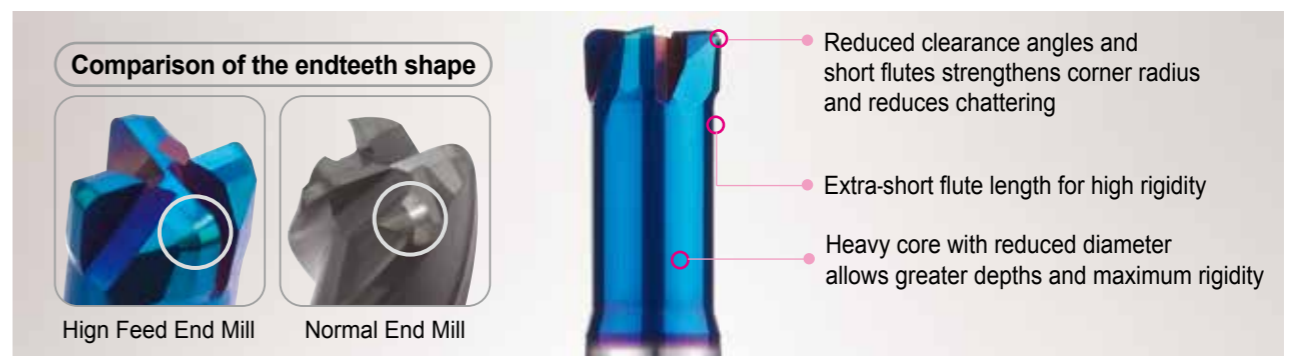

ISO	P										M				K					
	Non-alloy steel					Low alloy steel					High alloyed steel, and tool steel		Stainless steel		Grey cast iron		Nodular cast iron		Malleable cast iron	
Material Description	1	2	3	4	5	6	7	8	9	10	11	12	13	14	15	16	17	18	19	20
VDI 3323	1	2	3	4	5	6	7	8	9	10	11	12	13	14	15	16	17	18	19	20
HRc	125	13	25	28	32	10	29	32	38	15	35	15	23	10	10	26	3	25	4	21
HB	125	190	250	270	300	180	275	300	350	200	325	200	240	180	180	260	160	250	130	230
Recommend	○										○	○	○	○	○	○	○	○	○	○

ISO	N					S					H										
	Aluminum-wrought alloy		Aluminum-cast, alloyed			Copper and Copper Alloys (Bronze / Brass)		Non Metallic Materials			Heat Resistant Super Alloys		Titanium Alloys	Hardened steel	Chilled Cast Iron	Hardened Cast Iron					
Material Description	21	22	23	24	25	26	27	28	29	30	31	32	33	34	35	36	37	38	39	40	41
VDI 3323	21	22	23	24	25	26	27	28	29	30	31	32	33	34	35	36	37	38	39	40	41
HRc	60	100	75	90	130	110	90	100			15	30	25	38	34	55	60	55	60	42	55
HB	60	100	75	90	130	110	90	100			200	280	250	350	320	400 Rm	1050 Rm	550	630	400	550
Recommend	◎										◎	◎	◎	◎	◎	◎	◎	◎	◎	◎	◎

CARBIDE, 4 FLUTE STUB LENGTH CORNER RADIUS HIGH FEED (long shank)

● **VOLLHARTMETALL, 4 SCHNEIDEN EXTER KURZ ECKENRADIUS HOCHVORSCHUB**
 (●) **Fraise carbure, 4 dents, torique, grande avance, extra-courte**
 (●) **4 TAGLIENTI, TORICA EXTRA LUNGA**

- ▶ Excellent wear resistance at heavy feed rates on high hardened material.
- ▶ Designed with reduced clearance angles and short flutes for strength.
- ▶ High hardness & heat resistance coating for long life in dry applications.
- ▶ Hervorragende Verschleißigenschaften bei hohen Schnittwerten in gehärteten Materialien
- ▶ Mit reduzierten Freiwinkeln und kurzen Spannuten für hohe Festigkeiten konstruiert.
- ▶ Große Härte u. hitzebeständige Beschichtung für lange Lebensdauer bei Trockenbearbeitung

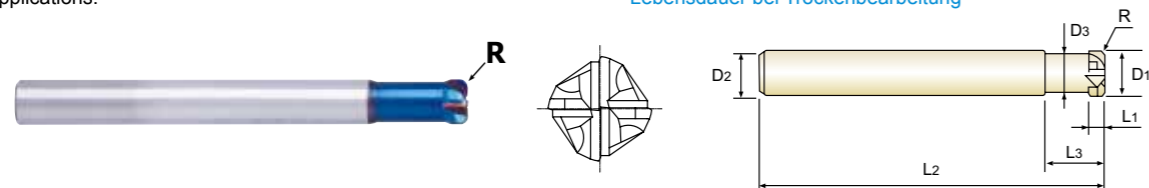

Plain Shank	Page
HYDRAULIC CHUCK SHRINK FIT HOLDER	D15-46 D47-72
POWER MILLING CHUCK	D161-176
ER COLLET CHUCK SK SLIM CHUCK	D73-116 D183-201

Unit : mm

EDP No.	Corner Radius	Mill Diameter	Shank Diameter	Length of Cut	Length Below Shank	Overall Length	Neck Diameter
	R (±0.005)	D1	D2	L1	L3	L2	D3
G8B5402005	R0.5	2.0	6	1	6	70	1.8
G8B5403005	R0.5	3.0	6	1.2	8	70	2.8
G8B5404005	R0.5	4.0	6	1.5	10	70	3.8
G8B5405005	R0.5	5.0	6	2	10	70	4.6
G8B5406005	R0.5	6.0	6	2.5	12	90	5.4
G8B5406010	R1.0	6.0	6	2.5	12	90	5.4
G8B5408010	R1.0	8.0	8	3.5	16	100	7.2
G8B5408020	R2.0	8.0	8	3.5	16	100	7.2
G8B5410010	R1.0	10.0	10	4	20	100	9
G8B5410020	R2.0	10.0	10	4	20	100	9
G8B5412020	R2.0	12.0	12	5	25	110	11
G8B5412030	R3.0	12.0	12	5	25	110	11
G8B5416030	R3.0	16.0	16	6.5	30	130	15

Due to the characteristics of the blue decoration layer, it might be erased during short term use and the color layer might not be uniformed. However, it doesn't affect the performance of the tool.

Mill Dia. Tolerance (mm)	Corner Radius Tolerance (mm)	Shank Dia. Tolerance
0 ~ -0.02	± 0.005	h5

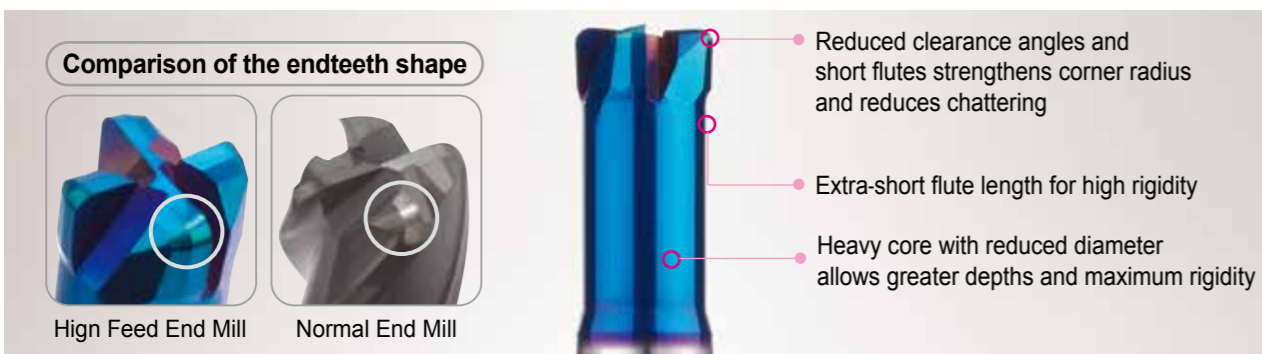

◎ : Excellent ○ : Good

ISO	P										M						K																										
	Non-alloy steel					Low alloy steel					High alloyed steel, and tool steel		Stainless steel				Grey cast iron		Nodular cast iron		Malleable cast iron																						
Material Description	1	2	3	4	5	6	7	8	9	10	11	12	13	14	15	16	17	18	19	20	21	22	23	24	25	26	27	28	29	30	31	32	33	34	35	36	37	38	39	40	41		
VDI 3323	1	2	3	4	5	6	7	8	9	10	11	12	13	14	15	16	17	18	19	20	21	22	23	24	25	26	27	28	29	30	31	32	33	34	35	36	37	38	39	40	41		
HRc	13	25	28	32	38	10	29	32	38	15	35	15	23	10	10	26	3	25	21	21	22	23	24	25	26	27	28	29	30	31	32	33	34	35	36	37	38	39	40	41			
HB	125	190	250	270	300	180	275	300	350	200	325	200	240	180	180	260	160	250	130	230	21	22	23	24	25	26	27	28	29	30	31	32	33	34	35	36	37	38	39	40	41		
Recommend					○				○	○																																	

CARBIDE, 2 FLUTE BALL NOSE for RIB PROCESSING

● **VOLLHARTMETALL, 2 SCHNEIDEN STIRNRADIUS für SCHMALE RIPPEN**
 (●) **Fraise carbure, 2 dents, hémisphérique pour usinage de rainure**
 (●) **2 TAGLIENTI, SEMISFERICA, SCARICATA PER NERVATURE**

- ▶ Designed to machine high hardened materials.
- ▶ Suitable for dry cutting, high speed cutting thanks to newly developed raw-material and new coating.
- ▶ Excellent workpiece finish.
- ▶ Designed for high precision milling operation.
- ▶ Higher wear-resistance.
- ▶ Geeignet zum Fräsen hochgehärteter Stähle.
- ▶ Geeignet zum Trockenfräsen und HSC-Fräsen dank neuentwickeltem Material und Beschichtung.
- ▶ Excellente Werkstückoberflächen.
- ▶ Geeignet für hochpräzises Fräsen.
- ▶ Höhere Verschleißfestigkeit.

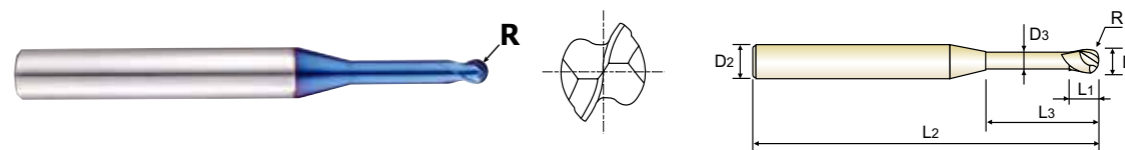

Plain Shank	Page
HYDRAULIC CHUCK SHRINK FIT HOLDER	D15-46 D47-72
POWER MILLING CHUCK	D161-176
ER COLLET CHUCK SK SLIM CHUCK	D73-116 D183-201

Unit : mm

EDP No.	Radius of Ball Nose	Mill Diameter	Shank Diameter	Length of Cut	Length Below Shank	Overall Length	Neck Diameter
	R (±0.005)	D1	D2	L1	L3	L2	D3
G8A46805	R0.05	0.1	4	0.1	0.3	45	0.085
G8A46806	R0.05	0.1	4	0.1	0.5	45	0.085
G8A46002	R0.1	0.2	4	0.2	0.5	45	0.17
G8A46977	R0.1	0.2	4	0.2	1	45	0.17
G8A46958	R0.1	0.2	4	0.2	1.5	45	0.17
G8A46003	R0.15	0.3	4	0.3	1	45	0.27
G8A46959	R0.15	0.3	4	0.3	2	45	0.27
G8A46986	R0.15	0.3	4	0.3	3	45	0.27
G8A46004	R0.2	0.4	4	0.4	1	45	0.37
G8A46960	R0.2	0.4	4	0.4	2	45	0.37
G8A46961	R0.2	0.4	4	0.4	3	45	0.37
G8A46981	R0.2	0.4	4	0.4	4	45	0.37
G8A46987	R0.2	0.4	4	0.4	5	45	0.37
G8A46005	R0.25	0.5	4	0.4	2	45	0.45
G8A46804	R0.25	0.5	4	0.4	2.5	45	0.45
G8A46962	R0.25	0.5	4	0.4	4	45	0.45
G8A46963	R0.25	0.5	4	0.4	6	45	0.45
G8A46964	R0.25	0.5	4	0.4	8	45	0.45
G8A46957	R0.3	0.6	4	0.5	2	45	0.55
G8A46988	R0.3	0.6	4	0.5	3	45	0.55
G8A46915	R0.3	0.6	4	0.5	4	45	0.55
G8A46989	R0.3	0.6	4	0.5	5	45	0.55

Due to the characteristics of the blue decoration layer, it might be erased during short term use and the color layer might not be uniformed. However, it doesn't affect the performance of the tool. ▶ NEXT PAGE

Mill Dia. Tolerance (mm)	Shank Dia. Tolerance
0 ~ - 0.012	h5

◎ : Excellent ○ : Good

ISO	P										M						K																									
	Non-alloy steel					Low alloy steel					High alloyed steel, and tool steel		Stainless steel				Grey cast iron		Nodular cast iron		Malleable cast iron																					
Material Description	1	2	3	4	5	6	7	8	9	10	11	12	13	14	15	16	17	18	19	20	21	22	23	24	25	26	27	28	29	30	31	32	33	34	35	36	37	38	39	40	41	
VDI 3323	1	2	3	4	5	6	7	8	9	10	11	12	13	14	15	16	17	18	19	20	21	22	23	24	25	26	27	28	29	30	31	32	33	34	35	36	37	38	39	40	41	
HRc	13	25	28	32	38	10	29	32	38	15	35	15	23	10	10	26	3	25	21	21	22	23	24	25	26	27	28	29	30	31	32	33	34	35	36	37	38	39	40	41		
HB	125	190	250	270	300	180	275	300	350	200	325	200	240	180	180	260	160	250	130	230	21	22	23	24	25	26	27	28	29	30	31	32	33	34	35	36	37	38	39	40	41	
Recommend					○				○	○																																



PLAIN SHANK **G8A46** SERIES

CARBIDE, 2 FLUTE BALL NOSE for RIB PROCESSING

- VOLLHARTMETALL, 2 SCHNEIDEN STIRNRADIUS für SCHMALE RIPPEN
- ① Fraise carbure, 2 dents, hémisphérique pour usinage de rainure
- ② 2 TAGLIENTI, SEMISFERICA, SCARICATA PER NERVATURE

- ▶ Designed to machine high hardened materials.
- ▶ Suitable for dry cutting, high speed cutting thanks to newly developed raw-material and new coating.
- ▶ Excellent workpiece finishes.
- ▶ Designed for high precision milling operation.
- ▶ Higher wear-resistance.

- ▶ Geeignet zum Fräsen hochgehärteter Stähle.
- ▶ Geeignet zum Trockenfräsen und HSC-Fräsen dank neuentwickeltem Material und Beschichtung.
- ▶ Exzellente Werkstückoberflächen.
- ▶ Geeignet für hochpräzises Fräsen.
- ▶ Höhere Verschleißfestigkeit.

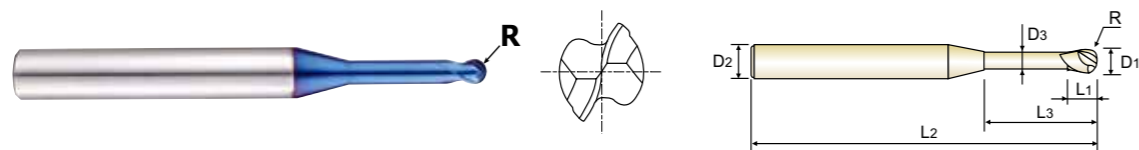

Unit : mm

EDP No.	Radius of Ball Nose	Mill Diameter	Shank Diameter	Length of Cut	Length Below Shank	Overall Length	Neck Diameter
	R (±0.005)	D1	D2	L1	L3	L2	D3
G8A46916	R0.3	0.6	4	0.5	6	45	0.55
G8A46917	R0.3	0.6	4	0.5	8	45	0.55
G8A46990	R0.3	0.6	4	0.5	10	45	0.55
G8A46918	R0.4	0.8	4	0.6	2	45	0.75
G8A46919	R0.4	0.8	4	0.6	4	45	0.75
G8A46008	R0.4	0.8	4	0.6	6	45	0.75
G8A46901	R0.4	0.8	4	0.6	8	45	0.75
G8A46965	R0.4	0.8	4	0.6	10	45	0.75
G8A46920	R0.5	1.0	4	0.8	3	45	0.95
G8A46921	R0.5	1.0	4	0.8	4	45	0.95
G8A46923	R0.5	1.0	4	0.8	5	45	0.95
G8A46010	R0.5	1.0	4	0.8	6	45	0.95
G8A46924	R0.5	1.0	4	0.8	7	45	0.95
G8A46902	R0.5	1.0	4	0.8	8	45	0.95
G8A46925	R0.5	1.0	4	0.8	9	45	0.95
G8A46903	R0.5	1.0	4	0.8	10	45	0.95
G8A46904	R0.5	1.0	4	0.8	12	45	0.95
G8A46926	R0.5	1.0	4	0.8	14	50	0.95
G8A46927	R0.5	1.0	4	0.8	16	50	0.95
G8A46966	R0.5	1.0	4	0.8	20	55	0.95
G8A46982	R0.6	1.2	4	1.0	6	45	1.15
G8A46012	R0.6	1.2	4	1.0	8	45	1.15

Due to the characteristics of the blue decoration layer, it might be erased during short term use and the color layer might not be uniformed. However, it doesn't affect the performance of the tool. ▶ NEXT PAGE

Mill Dia. Tolerance (mm)	Shank Dia. Tolerance
0 ~ - 0.012	h5

◎ : Excellent ○ : Good

ISO	P										M				K					
	Non-alloy steel					Low alloy steel					High alloyed steel, and tool steel		Stainless steel		Grey cast iron	Nodular cast iron		Malleable cast iron		
Material Description	1	2	3	4	5	6	7	8	9	10	11	12	13	14	15	16	17	18	19	20
VDI 3323	1	2	3	4	5	6	7	8	9	10	11	12	13	14	15	16	17	18	19	20
HRc	13	25	28	32	32	10	29	32	38	15	35	15	23	10	10	26	3	25	21	21
HB	125	190	250	270	300	180	275	300	350	200	325	200	240	180	180	260	160	250	130	230
Recommend					○				○											

ISO	N					S					H										
	Aluminum-wrought alloy		Aluminum-cast, alloyed		Copper and Copper Alloys (Bronze / Brass)	Heat Resistant Super Alloys		Titanium Alloys		Hardened steel	Chilled Cast Iron	Hardened Cast Iron									
Material Description	21	22	23	24	25	26	27	28	29	30	31	32	33	34	35	36	37	38	39	40	41
VDI 3323	21	22	23	24	25	26	27	28	29	30	31	32	33	34	35	36	37	38	39	40	41
HRc	21	22	23	24	25	26	27	28	29	30	31	32	33	34	35	36	37	38	39	40	41
HB	60	100	75	90	130	110	90	100			200	280	250	350	320	400 Rm	1050 Rm	550	630	400	550
Recommend											◎	◎						◎	◎	○	◎



PLAIN SHANK **G8A46** SERIES

CARBIDE, 2 FLUTE BALL NOSE for RIB PROCESSING

- VOLLHARTMETALL, 2 SCHNEIDEN STIRNRADIUS für SCHMALE RIPPEN
- ① Fraise carbure, 2 dents, hémisphérique pour usinage de rainure
- ② 2 TAGLIENTI, SEMISFERICA, SCARICATA PER NERVATURE

- ▶ Designed to machine high hardened materials.
- ▶ Suitable for dry cutting, high speed cutting thanks to newly developed raw-material and new coating.
- ▶ Excellent workpiece finish.
- ▶ Designed for high precision milling operation.
- ▶ Higher wear-resistance.

- ▶ Geeignet zum Fräsen hochgehärteter Stähle.
- ▶ Geeignet zum Trockenfräsen und HSC-Fräsen dank neuentwickeltem Material und Beschichtung.
- ▶ Exzellente Werkstückoberflächen.
- ▶ Geeignet für hochpräzises Fräsen.
- ▶ Höhere Verschleißfestigkeit.

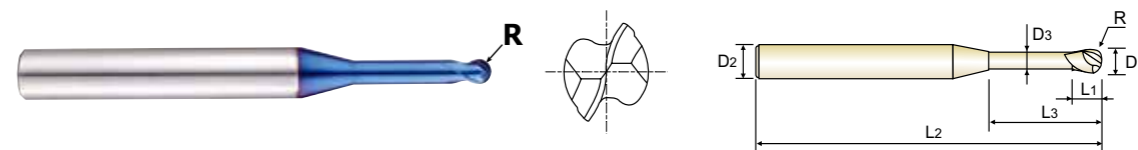

Unit : mm

EDP No.	Radius of Ball Nose	Mill Diameter	Shank Diameter	Length of Cut	Length Below Shank	Overall Length	Neck Diameter
	R (±0.005)	D1	D2	L1	L3	L2	D3
G8A46983	R0.6	1.2	4	1.0	10	45	1.15
G8A46905	R0.6	1.2	4	1.0	12	45	1.15
G8A46930	R0.75	1.5	4	1.2	6	45	1.45
G8A46015	R0.75	1.5	4	1.2	8	45	1.45
G8A46931	R0.75	1.5	4	1.2	10	45	1.45
G8A46906	R0.75	1.5	4	1.2	12	45	1.45
G8A46992	R0.75	1.5	4	1.2	14	50	1.45
G8A46907	R0.75	1.5	4	1.2	16	50	1.45
G8A46932	R0.75	1.5	4	1.2	20	55	1.45
G8A46939	R1.0	2.0	4	1.6	4	45	1.95
G8A46940	R1.0	2.0	4	1.6	6	45	1.95
G8A46020	R1.0	2.0	4	1.6	8	45	1.95
G8A46941	R1.0	2.0	4	1.6	10	45	1.95
G8A46942	R1.0	2.0	4	1.6	12	50	1.95
G8A46943	R1.0	2.0	4	1.6	14	50	1.95
G8A46909	R1.0	2.0	4	1.6	16	50	1.95
G8A46993	R1.0	2.0	4	1.6	18	55	1.95
G8A46910	R1.0	2.0	4	1.6	20	55	1.95
G8A46944	R1.0	2.0	4	1.6	22	60	1.95
G8A46945	R1.0	2.0	4	1.6	25	60	1.95
G8A46967	R1.0	2.0	4	1.6	30	70	1.95
G8A46948	R1.5	3.0	6	2.4	12	50	2.85

Due to the characteristics of the blue decoration layer, it might be erased during short term use and the color layer might not be uniformed. However, it doesn't affect the performance of the tool. ▶ NEXT PAGE

Mill Dia. Tolerance (mm)	Shank Dia. Tolerance
0 ~ - 0.012	h5

◎ : Excellent ○ : Good

ISO	P										M				K					
	Non-alloy steel					Low alloy steel					High alloyed steel, and tool steel		Stainless steel		Grey cast iron	Nodular cast iron		Malleable cast iron		
Material Description	1	2	3	4	5	6	7	8	9	10	11	12	13	14	15	16	17	18	19	20
VDI 3323	1	2	3	4	5	6	7	8	9	10	11	12	13	14	15	16	17	18	19	20
HRc	13	25	28	32	32	10	29	32	38	15	35	15	23	10	10	26	3	25	21	21
HB	125	190	250	270	300	180	275	300	350	200	325	200	240	180	180	260	160	250	130	230
Recommend					○				○											

ISO	N					S					H										
	Aluminum-wrought alloy		Aluminum-cast, alloyed		Copper and Copper Alloys (Bronze / Brass)	Heat Resistant Super Alloys		Titanium Alloys		Hardened steel	Chilled Cast Iron	Hardened Cast Iron									
Material Description	21	22	23	24	25	26	27	28	29	30	31	32	33	34	35	36	37	38	39	40	41
VDI 3323	21	22	23	24	25	26	27	28	29	30	31	32	33	34	35	36	37	38	39	40	41
HRc	21	22	23	24	25	26	27	28	29	30	31	32	33	34	35	36	37	38	39	40	41
HB	60	100	75	90	130	110	90	100			200	280	250	350	320	400 Rm	1050 Rm	550	630	400	550
Recommend											◎	◎						◎	◎	○	◎

CARBIDE, 2 FLUTE BALL NOSE for RIB PROCESSING

- VOLLHARTMETALL, 2 SCHNEIDEN STIRNRADIUS für SCHMALE RIPPEN
- ① Fraise carbure, 2 dents, hémisphérique pour usinage de rainure
- ② 2 TAGLIENTI, SEMISFERICA, SCARICATA PER NERVATURE

- ▶ Designed to machine high hardened materials.
- ▶ Suitable for dry cutting, high speed cutting thanks to newly developed raw-material and new coating.
- ▶ Excellent workpiece finish.
- ▶ Designed for high precision milling operation.
- ▶ Higher wear-resistance.

- ▶ Geeignet zum Fräsen hochgehärteter Stähle.
- ▶ Geeignet zum Trockenfräsen und HSC-Fräsen dank neuentwickeltem Material und Beschichtung.
- ▶ Excellente Werkstückoberflächen.
- ▶ Geeignet für hochpräzises Fräsen.
- ▶ Höhere Verschleißfestigkeit.

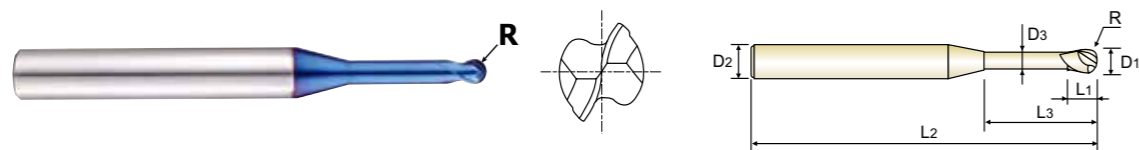

CARBIDE 2 30° ±0.005 PLAIN BLUE p.C124-125

Recommended ToolHolder: Plain Shank, Hydraulic Chuck, Shrink Fit Holder, Power Milling Chuck, ER Collet Chuck, SK Slim Chuck. Page: D15-46, D47-72, D161-176, D73-116, D183-201.

Unit : mm

EDP No.	Radius of Ball Nose	Mill Diameter	Shank Diameter	Length of Cut	Length Below Shank	Overall Length	Neck Diameter
	R (±0.005)	D1	D2	L1	L3	L2	D3
G8A46984	R1.5	3.0	6	2.4	14	55	2.85
G8A46030	R1.5	3.0	6	2.4	16	55	2.85
G8A46985	R1.5	3.0	6	2.4	18	60	2.85
G8A46911	R1.5	3.0	6	2.4	20	60	2.85
G8A46968	R1.5	3.0	6	2.4	25	65	2.85
G8A46969	R1.5	3.0	6	2.4	30	70	2.85
G8A46970	R1.5	3.0	6	2.4	35	80	2.85
G8A46950	R2.0	4.0	6	3.2	12	60	3.85
G8A46040	R2.0	4.0	6	3.2	16	60	3.85
G8A46912	R2.0	4.0	6	3.2	20	65	3.85
G8A46913	R2.0	4.0	6	3.2	25	70	3.85
G8A46971	R2.0	4.0	6	3.2	30	70	3.85
G8A46972	R2.0	4.0	6	3.2	35	80	3.85
G8A46973	R2.0	4.0	6	3.2	40	90	3.85
G8A46974	R2.0	4.0	6	3.2	45	90	3.85
G8A46975	R2.0	4.0	6	3.2	50	100	3.85

Due to the characteristics of the blue decoration layer, it might be erased during short term use and the color layer might not be uniformed. However, it doesn't affect the performance of the tool. ▶ NEXT PAGE

Mill Dia. Tolerance (mm)	Shank Dia. Tolerance
0 ~ - 0.012	h5

◎ : Excellent ○ : Good

ISO Material Description	P										M				K					
	Non-alloy steel					Low alloy steel					High alloyed steel, and tool steel		Stainless steel		Grey cast iron	Nodular cast iron		Malleable cast iron		
VDI 3323	1	2	3	4	5	6	7	8	9	10	11	12	13	14	15	16	17	18	19	20
HRc	13	25	28	32	30	10	29	32	38	15	35	15	23	10	10	26	3	25	21	
HB	125	190	250	270	300	180	275	300	350	200	325	200	240	180	180	260	160	250	130	230
Recommend	○										○		○		○					

ISO Material Description	N					S					H											
	Aluminum-wrought alloy		Aluminum-cast, alloyed		Copper and Copper Alloys (Bronze / Brass)	Non Metallic Materials		Heat Resistant Super Alloys			Titanium Alloys		Hardened steel	Chilled Cast Iron	Hardened Cast Iron							
VDI 3323	21	22	23	24	25	26	27	28	29	30	31	32	33	34	35	36	37	38	39	40	41	
HRc	15	30	25	38	34						15	30	25	38	34			55	60	42	55	
HB	60	100	75	90	130	110	90	100			200	280	250	350	320	400 Rm	1050 Rm	550	630	400	550	
Recommend	◎		◎		◎	◎		◎			◎		◎		◎		◎		◎		◎	

CARBIDE, 2 FLUTE BALL NOSE for RIB PROCESSING

- VOLLHARTMETALL, 2 SCHNEIDEN STIRNRADIUS für SCHMALE RIPPEN
- ① Fraise carbure, 2 dents, hémisphérique pour usinage de rainure
- ② 2 TAGLIENTI, SEMISFERICA, SCARICATA PER NERVATURE

- ▶ Designed to machine high hardened materials.
- ▶ Suitable for dry cutting, high speed cutting thanks to newly developed raw-material and new coating.
- ▶ Excellent workpiece finish.
- ▶ Designed for high precision milling operation.
- ▶ Higher wear-resistance.

- ▶ Geeignet zum Fräsen hochgehärteter Stähle.
- ▶ Geeignet zum Trockenfräsen und HSC-Fräsen dank neuentwickeltem Material und Beschichtung.
- ▶ Excellente Werkstückoberflächen.
- ▶ Geeignet für hochpräzises Fräsen.
- ▶ Höhere Verschleißfestigkeit.

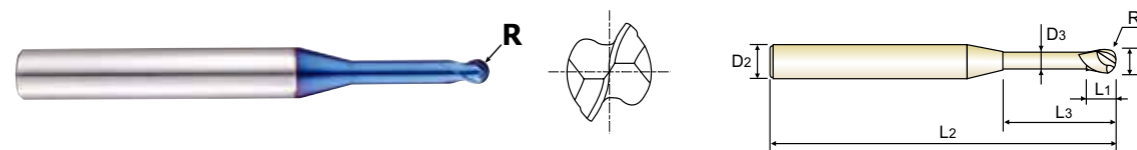

CARBIDE 2 30° ±0.005 PLAIN BLUE p.C124-125

Recommended ToolHolder: Plain Shank, Hydraulic Chuck, Shrink Fit Holder, Power Milling Chuck, ER Collet Chuck, SK Slim Chuck. Page: D15-46, D47-72, D161-176, D73-116, D183-201.

Unit : mm

EDP No.	Radius of Ball Nose	Mill Diameter	Shank Diameter	Length of Cut	Length Below Shank	Overall Length	Neck Diameter
	R (±0.005)	D1	D2	L1	L3	L2	D3
G8A54005	R0.25	0.5	6	0.5	1.5	50	0.45
G8A54901	R0.25	0.5	6	0.5	3.3	50	0.45
G8A54006	R0.3	0.6	6	0.6	2	50	0.55
G8A54902	R0.3	0.6	6	0.6	4	50	0.55
G8A54008	R0.4	0.8	6	0.8	2.5	50	0.75
G8A54903	R0.4	0.8	6	0.8	5.5	50	0.75
G8A54010	R0.5	1.0	6	1	3.3	50	0.95
G8A54904	R0.5	1.0	6	1	6.7	50	0.95
G8A54905	R0.5	1.0	6	1	12	50	0.95
G8A54012	R0.6	1.2	6	1.2	4.4	50	1.15
G8A54906	R0.6	1.2	6	1.2	8	50	1.15
G8A54015	R0.75	1.5	6	1.5	5	50	1.45
G8A54907	R0.75	1.5	6	1.5	9.7	50	1.45
G8A54908	R0.75	1.5	6	1.5	15	50	1.45
G8A54020	R1.0	2.0	6	2	6	50	1.95
G8A54909	R1.0	2.0	6	2	13	50	1.95
G8A54910	R1.0	2.0	6	2	20	60	1.95

Due to the characteristics of the blue decoration layer, it might be erased during short term use and the color layer might not be uniformed. However, it doesn't affect the performance of the tool.

Mill Dia. Tolerance (mm)	Shank Dia. Tolerance
0 ~ - 0.012	h5

◎ : Excellent ○ : Good

ISO Material Description	P										M				K					
	Non-alloy steel					Low alloy steel					High alloyed steel, and tool steel		Stainless steel		Grey cast iron	Nodular cast iron		Malleable cast iron		
VDI 3323	1	2	3	4	5	6	7	8	9	10	11	12	13	14	15	16	17	18	19	20
HRc	13	25	28	32	30	10	29	32	38	15	35	15	23	10	10	26	3	25	21	
HB	125	190	250	270	300	180	275	300	350	200	325	200	240	180	180	260	160	250	130	230
Recommend	○										○		○		○					

ISO Material Description	N					S					H											
	Aluminum-wrought alloy		Aluminum-cast, alloyed		Copper and Copper Alloys (Bronze / Brass)	Non Metallic Materials		Heat Resistant Super Alloys			Titanium Alloys		Hardened steel	Chilled Cast Iron	Hardened Cast Iron							
VDI 3323	21	22	23	24	25	26	27	28	29	30	31	32	33	34	35	36	37	38	39	40	41	
HRc	15	30	25	38	34						15	30	25	38	34			55	60	42	55	
HB	60	100	75	90	130	110	90	100			200	280	250	350	320	400 Rm	1050 Rm	550	630	400	550	
Recommend	◎		◎		◎	◎		◎			◎		◎		◎		◎		◎		◎	



PLAIN SHANK **G8A28** SERIES

CARBIDE, 2 FLUTE BALL NOSE

- VOLLHARTMETALL, 2 SCHNEIDEN STIRNRADIUS
- ① Fraise carbure, 2 dents, hémisphérique
- ② 2 TAGLIENTI, SEMISFERICA

- ▶ Designed to machine high hardened materials.
- ▶ Suitable for dry cutting, high speed cutting thanks to newly developed raw-material and new coating.
- ▶ Excellent workpiece finish.
- ▶ Designed for high precision milling operation.
- ▶ Higher wear-resistance.

- ▶ Geeignet zum Fräsen hochgehärteter Stähle.
- ▶ Geeignet zum Trockenfräsen und HSC-Fräsen dank neuentwickeltem Material und Beschichtung.
- ▶ Excellente Werkstückoberflächen.
- ▶ Geeignet für hochpräzises Fräsen.
- ▶ Höhere Verschleißfestigkeit.

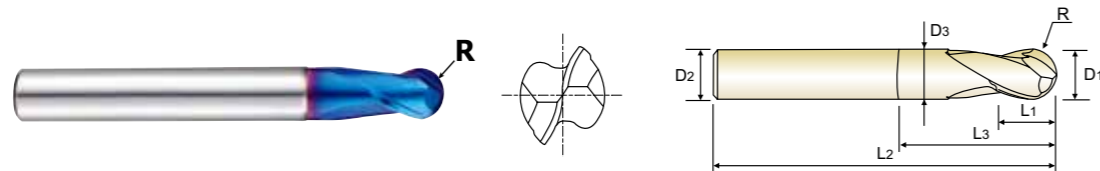

CARBIDE 2 30° R R PLAIN BLUE p.C126-127

Recommended ToolHolder: HYDRAULIC CHUCK SHRINK FIT HOLDER (D15-46, D47-72), POWER MILLING CHUCK (D161-176), ER COLLET CHUCK SK SLIM CHUCK (D73-116, D183-201)

EDP No.	Radius of Ball Nose	Mill Diameter	Shank Diameter	Length of Cut	Length Below Shank	Overall Length	Neck Diameter
	R	D1	D2	L1	L3	L2	D3
G8A28001	R0.05	0.1	4	0.2	-	40	-
G8A28002	R0.1	0.2	4	0.3	-	40	-
G8A28003	R0.15	0.3	4	0.5	-	40	-
G8A28004	R0.2	0.4	4	0.6	-	40	-
G8A28005	R0.25	0.5	4	0.7	-	40	-
G8A28006	R0.3	0.6	4	0.9	-	40	-
G8A28007	R0.35	0.7	4	1.1	-	40	-
G8A28008	R0.4	0.8	4	1.2	-	40	-
G8A28009	R0.45	0.9	4	1.4	-	40	-
G8A280104S	R0.5	1.0	4	1.5	3	50	0.95
G8A28010	R0.5	1.0	6	1.5	3	50	0.95
G8A280154S	R0.75	1.5	4	2	4	50	1.45
G8A28015	R0.75	1.5	6	2	4	50	1.45
G8A280204S	R1.0	2.0	4	2.5	5	50	1.95
G8A28020	R1.0	2.0	6	2.5	5	50	1.95
G8A280254S	R1.25	2.5	4	3	7	50	2.4
G8A28025	R1.25	2.5	6	3	7	50	2.4
G8A28030	R1.5	3.0	6	4	10	60	2.85
G8A28035	R1.75	3.5	6	4.5	10	60	3.35
G8A28040	R2.0	4.0	6	5	10	60	3.85
G8A28045	R2.25	4.5	6	5.5	10	60	4.35
G8A28050	R2.5	5.0	6	6	12	60	4.85

Due to the characteristics of the blue decoration layer, it might be erased during short term use and the color layer might not be uniformed. However, it doesn't affect the performance of the tool. ▶ NEXT PAGE

Size	Radius Tolerance (mm)	Mill Dia. Tolerance (mm)	Shank Dia. Tolerance
up to R3	± 0.005	0 ~ - 0.012	h5
over R3	± 0.010	0 ~ - 0.015	

◎ : Excellent ○ : Good

ISO Material Description	P										M				K					
	Non-alloy steel					Low alloy steel					High alloyed steel, and tool steel		Stainless steel		Grey cast iron	Nodular cast iron		Malleable cast iron		
VDI 3323	1	2	3	4	5	6	7	8	9	10	11	12	13	14	15	16	17	18	19	20
HRc	13	25	28	32	30	10	29	32	38	15	35	15	23	10	10	26	3	25	21	21
HB	125	190	250	270	300	180	275	300	350	200	325	200	240	180	180	260	160	250	130	230
Recommend	○										○		○		○					

ISO Material Description	N					S					H										
	Aluminum-wrought alloy		Aluminum-cast, alloyed		Copper and Copper Alloys (Bronze / Brass)	Non Metallic Materials		Heat Resistant Super Alloys			Titanium Alloys		Hardened steel	Chilled Cast Iron	Hardened Cast Iron						
VDI 3323	21	22	23	24	25	26	27	28	29	30	31	32	33	34	35	36	37	38	39	40	41
HRc	15	30	25	38	34						55	60	42	55				55	60	42	55
HB	60	100	75	90	130	110	90	100			200	280	250	350	320	400 Rm	1050 Rm	550	630	400	550
Recommend	◎		◎		◎		◎			◎		◎		◎		◎		◎		◎	



PLAIN SHANK **G8A28** SERIES

CARBIDE, 2 FLUTE BALL NOSE

- VOLLHARTMETALL, 2 SCHNEIDEN STIRNRADIUS
- ① Fraise carbure, 2 dents, hémisphérique
- ② 2 TAGLIENTI, SEMISFERICA

- ▶ Designed to machine high hardened materials.
- ▶ Suitable for dry cutting, high speed cutting thanks to newly developed raw-material and new coating.
- ▶ Excellent workpiece finish.
- ▶ Designed for high precision milling operation.
- ▶ Higher wear-resistance.

- ▶ Geeignet zum Fräsen hochgehärteter Stähle.
- ▶ Geeignet zum Trockenfräsen und HSC-Fräsen dank neuentwickeltem Material und Beschichtung.
- ▶ Excellente Werkstückoberflächen.
- ▶ Geeignet für hochpräzises Fräsen.
- ▶ Höhere Verschleißfestigkeit.

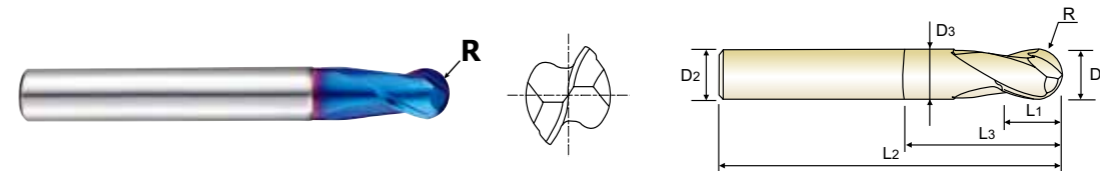

CARBIDE 2 30° R R PLAIN BLUE p.C126-127

Recommended ToolHolder: HYDRAULIC CHUCK SHRINK FIT HOLDER (D15-46, D47-72), POWER MILLING CHUCK (D161-176), ER COLLET CHUCK SK SLIM CHUCK (D73-116, D183-201)

EDP No.	Radius of Ball Nose	Mill Diameter	Shank Diameter	Length of Cut	Length Below Shank	Overall Length	Neck Diameter
	R (± 0.005)	D1	D2	L1	L3	L2	D3
G8A28055	R2.75	5.5	6	6.5	12	60	5.35
G8A28060	R3.0	6.0	6	7	15	60	5.85
G8A28903	R3.0	6.0	6	9	30	90	5.85
G8A28901	R4.0	8.0	8	9	15	60	7.7
G8A28080	R4.0	8.0	8	9	15	80	7.7
G8A28904	R4.0	8.0	8	12	30	100	7.7
G8A28902	R5.0	10.0	10	11	25	60	9.7
G8A28100	R5.0	10.0	10	11	25	80	9.7
G8A28905	R5.0	10.0	10	15	30	100	9.7
G8A28120	R6.0	12.0	12	14	25	80	11.7

Due to the characteristics of the blue decoration layer, it might be erased during short term use and the color layer might not be uniformed. However, it doesn't affect the performance of the tool.

Size	Radius Tolerance (mm)	Mill Dia. Tolerance (mm)	Shank Dia. Tolerance
up to R3	± 0.005	0 ~ - 0.012	h5
over R3	± 0.010	0 ~ - 0.015	

◎ : Excellent ○ : Good

ISO Material Description	P										M				K					
	Non-alloy steel					Low alloy steel					High alloyed steel, and tool steel		Stainless steel		Grey cast iron	Nodular cast iron		Malleable cast iron		
VDI 3323	1	2	3	4	5	6	7	8	9	10	11	12	13	14	15	16	17	18	19	20
HRc	13	25	28	32	30	10	29	32	38	15	35	15	23	10	10	26	3	25	21	21
HB	125	190	250	270	300	180	275	300	350	200	325	200	240	180	180	260	160	250	130	230
Recommend	○										○		○		○					

ISO Material Description	N					S					H										
	Aluminum-wrought alloy		Aluminum-cast, alloyed		Copper and Copper Alloys (Bronze / Brass)	Non Metallic Materials		Heat Resistant Super Alloys			Titanium Alloys		Hardened steel	Chilled Cast Iron	Hardened Cast Iron						
VDI 3323	21	22	23	24	25	26	27	28	29	30	31	32	33	34	35	36	37	38	39	40	41
HRc	15	30	25	38	34						55	60	42	55				55	60	42	55
HB	60	100	75	90	130	110	90	100			200	280	250	350	320	400 Rm	1050 Rm	550	630	400	550
Recommend	◎		◎		◎		◎			◎		◎		◎		◎		◎		◎	

CARBIDE, 2 FLUTE STUB LENGTH BALL NOSE with EXTENDED NECK

● **VOLLHARTMETALL, 2 SCHNEIDEN EXTRA KURZ STIRNRADIUS mit ABGESETZTEM SCHAFTTEIL**
 (●) **Fraise carbure, 2 dents, hémisphérique, détalonnée, extra-courte**
 (●) **2 TAGLIENTI, SEMISFERICA TAGLIENTE CORTO CON SCARICO ESTESO**

- ▶ Designed to machine high hardened materials.
- ▶ Suitable for dry cutting, high speed cutting thanks to newly developed raw-material and new coating.
- ▶ Excellent workpiece finish.
- ▶ Designed for high precision milling operation.
- ▶ Higher wear-resistance.

- ▶ Geeignet zum Fräsen hochgehärteter Stähle.
- ▶ Geeignet zum Trockenfräsen und HSC-Fräsen dank neuentwickeltem Material und Beschichtung.
- ▶ Excellente Werkstückoberflächen.
- ▶ Geeignet für hochpräzises Fräsen.
- ▶ Höhere Verschleißfestigkeit.

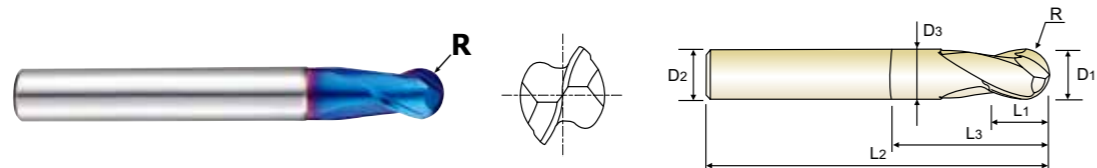

CARBIDE 2 30° ±0.005 ±0.010 PLAIN BLUE p.C126-127

Plain Shank	Page
HYDRAULIC CHUCK SHRINK FIT HOLDER	D15-46 D47-72
POWER MILLING CHUCK	D161-176
ER COLLET CHUCK SK SLIM CHUCK	D73-116 D183-201

R0.5-R3 R3.5-R12.5

Unit : mm

EDP No.	Radius of Ball Nose	Mill Diameter	Shank Diameter	Length of Cut	Length Below Shank	Overall Length	Neck Diameter
	R	D1	D2	L1	L3	L2	D3
G8A38010	R0.5	1.0	4	1	2.2	50	0.95
G8A38012	R0.6	1.2	4	1.2	2.6	50	1.15
G8A38015	R0.75	1.5	4	1.5	3	50	1.45
G8A380204S	R1.0	2.0	4	2	4	50	1.95
G8A38020	R1.0	2.0	6	2	4	50	1.95
G8A38030	R1.5	3.0	6	3	6	60	2.85
G8A38040	R2.0	4.0	6	4	8	70	3.85
G8A38050	R2.5	5.0	6	5	10	80	4.85
G8A38060	R3.0	6.0	6	6	12	90	5.85
G8A38070	R3.5	7.0	8	7	14	90	6.7
G8A38080	R4.0	8.0	8	8	16	100	7.7
G8A38090	R4.5	9.0	10	9	18	100	8.7
G8A38100	R5.0	10.0	10	10	20	100	9.7
G8A38120	R6.0	12.0	12	12	24	110	11.7
G8A38140	R7.0	14.0	14	14	28	110	13.7
G8A38160	R8.0	16.0	16	16	32	140	15.7
G8A38180	R9.0	18.0	18	18	36	140	17.7
G8A38200	R10.0	20.0	20	20	40	160	19.7
G8A38250	R12.5	25.0	25	25	50	180	24.7

Due to the characteristics of the blue decoration layer, it might be erased during short term use and the color layer might not be uniformed. However, it doesn't affect the performance of the tool.

Size	Radius Tolerance (mm)	Mill Dia. Tolerance (mm)	Shank Dia. Tolerance
up to R3	± 0.005	0 ~ - 0.012	h5
over R3	± 0.010	0 ~ - 0.015	

◎ : Excellent ○ : Good

ISO Material Description	P									M						K				
	Non-alloy steel			Low alloy steel			High alloyed steel, and tool steel			Stainless steel			Grey cast iron		Nodular cast iron		Malleable cast iron			
VDI 3323	1	2	3	4	5	6	7	8	9	10	11	12	13	14	15	16	17	18	19	20
HRc	13	25	28	32	30	10	29	32	38	15	35	15	23	10	10	26	3	25	21	
HB	125	190	250	270	300	180	275	300	350	200	325	200	240	180	180	260	160	250	130	230
Recommend	○									○						○				

ISO Material Description	N						S						H								
	Aluminum-wrought alloy		Aluminum-cast, alloyed		Copper and Copper Alloys (Bronze / Brass)		Heat Resistant Super Alloys			Titanium Alloys			Hardened steel	Chilled Cast Iron	Hardened Cast Iron						
VDI 3323	21	22	23	24	25	26	27	28	29	30	31	32	33	34	35	36	37	38	39	40	41
HRc											15	30	25	38	34			55	60	42	55
HB	60	100	75	90	130	110	90	100			200	280	250	350	320	400 Rm	1050 Rm	550	630	400	550
Recommend	◎						◎						◎								

CARBIDE, 2 FLUTE MINIATURE BALL NOSE

● **VOLLHARTMETALL, 2 SCHNEIDEN MINI STIRNRADIUS**
 (●) **Fraise carbure, 2 dents, hémisphérique, micro-fraise**
 (●) **2 TAGLIENTI, SEMISFERICA MINI**

- ▶ Designed to machine high hardened materials.
- ▶ Suitable for dry cutting, high speed cutting thanks to newly developed raw-material and new coating.
- ▶ Excellent workpiece finish.
- ▶ Designed for high precision milling operation.
- ▶ Higher wear-resistance.

- ▶ Geeignet zum Fräsen hochgehärteter Stähle.
- ▶ Geeignet zum Trockenfräsen und HSC-Fräsen dank neuentwickeltem Material und Beschichtung.
- ▶ Excellente Werkstückoberflächen.
- ▶ Geeignet für hochpräzises Fräsen.
- ▶ Höhere Verschleißfestigkeit.

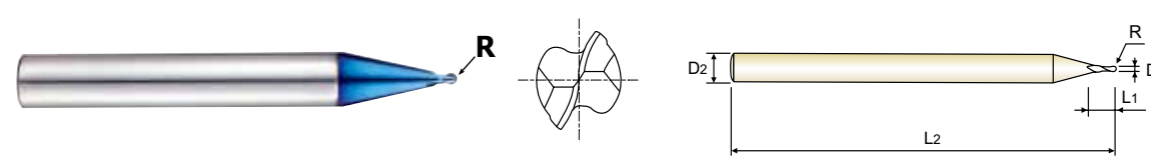

CARBIDE 2 30° ±0.005 PLAIN BLUE p.C126-127

Plain Shank	Page
HYDRAULIC CHUCK SHRINK FIT HOLDER	D15-46 D47-72
POWER MILLING CHUCK	D161-176
ER COLLET CHUCK SK SLIM CHUCK	D73-116 D183-201

Unit : mm

EDP No.	Radius of Ball Nose	Mill Diameter	Shank Diameter	Length of Cut	Overall Length
	R (±0.005)	D1	D2	L1	L2
G8A53004	R0.2	0.4	6	0.4	50
G8A53005	R0.25	0.5	6	0.5	50
G8A53006	R0.3	0.6	6	0.6	50
G8A53008	R0.4	0.8	6	0.8	50
G8A53010	R0.5	1.0	6	1.0	50
G8A53012	R0.6	1.2	6	1.2	50
G8A53015	R0.75	1.5	6	1.5	50
G8A53020	R1.0	2.0	6	2.0	50

Due to the characteristics of the blue decoration layer, it might be erased during short term use and the color layer might not be uniformed. However, it doesn't affect the performance of the tool.

Mill Dia. Tolerance (mm)	Shank Dia. Tolerance
0 ~ - 0.012	h5

◎ : Excellent ○ : Good

ISO Material Description	P									M						K				
	Non-alloy steel			Low alloy steel			High alloyed steel, and tool steel			Stainless steel			Grey cast iron		Nodular cast iron		Malleable cast iron			
VDI 3323	1	2	3	4	5	6	7	8	9	10	11	12	13	14	15	16	17	18	19	20
HRc	13	25	28	32	30	10	29	32	38	15	35	15	23	10	10	26	3	25	21	
HB	125	190	250	270	300	180	275	300	350	200	325	200	240	180	180	260	160	250	130	230
Recommend	○									○						○				

ISO Material Description	N						S						H								
	Aluminum-wrought alloy		Aluminum-cast, alloyed		Copper and Copper Alloys (Bronze / Brass)		Heat Resistant Super Alloys			Titanium Alloys			Hardened steel	Chilled Cast Iron	Hardened Cast Iron						
VDI 3323	21	22	23	24	25	26	27	28	29	30	31	32	33	34	35	36	37	38	39	40	41
HRc											15	30	25	38	34			55	60	42	55
HB	60	100	75	90	130	110	90	100			200	280	250	350	320	400 Rm	1050 Rm	550	630	400	550
Recommend	◎						◎						◎								



PLAIN SHANK **G8A59** SERIES

CARBIDE, 3 FLUTE BALL NOSE - Center Match

- VOLLHARTMETALL, 3 SCHNEIDEN STIRNRADIUS - Schneiden Mittelpunkt
- Fraise carbure, 3 dents, hémisphérique, coupe au centre
- 3 TAGLIENTI, SEMISFERICA

- ▶ Designed to machine high hardened materials.
- ▶ Suitable for dry cutting, high speed cutting thanks to newly developed raw-material and new coating.
- ▶ Excellent workpiece finish.
- ▶ Designed for high precision milling operation.
- ▶ Higher wear-resistance.

- ▶ Geeignet zum Fräsen hochgehärteter Stähle.
- ▶ Geeignet zum Trockenfräsen und HSC-Fräsen dank neuentwickeltem Material und Beschichtung.
- ▶ Excellente Werkstückoberflächen.
- ▶ Geeignet für hochpräzises Fräsen.
- ▶ Höhere Verschleißfestigkeit.

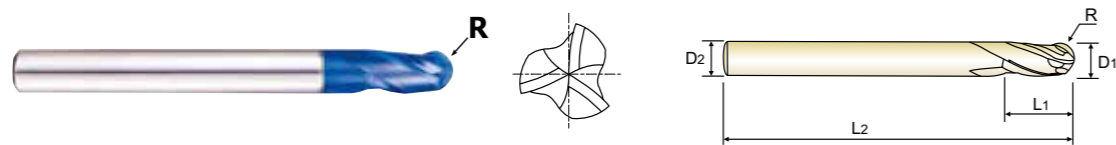

CARBIDE 3 30° ±0.005 ±0.010 PLAIN BLUE p.C128

Recommended ToolHolder

Plain Shank	Page
HYDRAULIC CHUCK	D15-46
SHRINK FIT HOLDER	D47-72
POWER MILLING CHUCK	D161-176
ER COLLET CHUCK	D73-116
SK SLIM CHUCK	D183-201

Unit : mm

EDP No.	Radius of Ball Nose	Mill Diameter	Shank Diameter	Length of Cut	Overall Length
	R	D1	D2	L1	L2
G8A59030	R1.5	3.0	6	8	60
G8A59040	R2.0	4.0	6	8	70
G8A59050	R2.5	5.0	6	10	80
G8A59060	R3.0	6.0	6	12	90
G8A59080	R4.0	8.0	8	14	100
G8A59100	R5.0	10.0	10	18	100
G8A59120	R6.0	12.0	12	22	110
G8A59160	R8.0	16.0	16	30	140
G8A59200	R10.0	20.0	20	38	160

Due to the characteristics of the blue decoration layer, it might be erased during short term use and the color layer might not be uniformed. However, it doesn't affect the performance of the tool.

Size	Radius Tolerance (mm)	Mill Dia. Tolerance (mm)	Shank Dia. Tolerance
up to R3	± 0.005	0 ~ - 0.012	h5
over R3	± 0.010	0 ~ - 0.015	

◎ : Excellent ○ : Good

ISO	P										M				K					
	Non-alloy steel					Low alloy steel					High alloyed steel, and tool steel		Stainless steel		Grey cast iron		Nodular cast iron		Malleable cast iron	
Material Description	1	2	3	4	5	6	7	8	9	10	11	12	13	14	15	16	17	18	19	20
VDI 3323	1	2	3	4	5	6	7	8	9	10	11	12	13	14	15	16	17	18	19	20
HRc	13	25	28	32	30	29	32	38	35	35	35	15	23	10	10	26	3	25	21	21
HB	125	190	250	270	300	180	275	300	350	200	325	200	240	180	180	260	160	250	130	230
Recommend	○										○				○					

ISO	N					S					H										
	Aluminum-wrought alloy		Aluminum-cast, alloyed		Copper and Copper Alloys (Bronze / Brass)	Non Metallic Materials	Heat Resistant Super Alloys				Titanium Alloys		Hardened steel	Chilled Cast Iron	Hardened Cast Iron						
Material Description	21	22	23	24	25	26	27	28	29	30	31	32	33	34	35	36	37	38	39	40	41
VDI 3323	21	22	23	24	25	26	27	28	29	30	31	32	33	34	35	36	37	38	39	40	41
HRc	21	22	23	24	25	26	27	28	29	30	15	30	25	38	34	55	60	42	55	55	55
HB	60	100	75	90	130	110	90	100			200	280	250	350	320	400 Rm	1050 Rm	550	630	400	550
Recommend	◎					◎					◎				◎						



PLAIN SHANK **G8D62** SERIES

CARBIDE, 4 FLUTE BALL NOSE - Center Match

- VOLLHARTMETALL, 4 SCHNEIDEN STIRNRADIUS - Schneiden Mittelpunkt
- Fraise carbure, 4 dents, hémisphérique - coupe au centre
- 4 TAGLIENTI, SEMISFERICA - 4 TAGLIENTI A CENTRO FRESA

- ▶ Applied center match type & special new design on ball center shape.
- ▶ Excellent high wear resistance and high performance.
- ▶ Applied for high speed and feed.
- ▶ Increased the surface roughness.

- ▶ Neues Design der Kugelschneidengeometrie
- ▶ Hohe Verschleißfestigkeit, hohe Leistung.
- ▶ Geeignet für hohe Schnittgeschwindigkeiten und hohe Vorschübe
- ▶ verbessert deutlich die Oberflächenrauigkeit

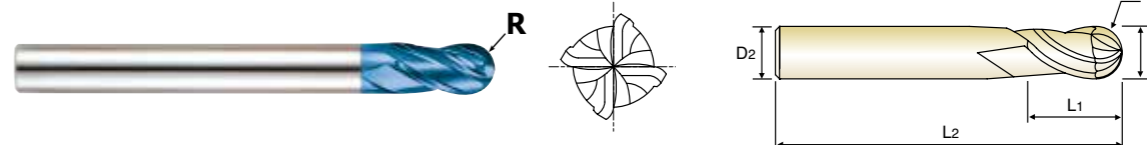

CARBIDE 4 30° ±0.005 ±0.010 PLAIN BLUE p.C129

Recommended ToolHolder

Plain Shank	Page
HYDRAULIC CHUCK	D15-46
SHRINK FIT HOLDER	D47-72
POWER MILLING CHUCK	D161-176
ER COLLET CHUCK	D73-116
SK SLIM CHUCK	D183-201

Unit : mm

EDP No.	Radius of Ball Nose	Mill Diameter	Shank Diameter	Length of Cut	Overall Length
	R	D1	D2	L1	L2
G8D62030	R1.5	3.0	6	8	60
G8D62040	R2.0	4.0	6	8	70
G8D62050	R2.5	5.0	6	10	80
G8D62060	R3.0	6.0	6	12	90
G8D62080	R4.0	8.0	8	14	100
G8D62100	R5.0	10.0	10	18	100
G8D62120	R6.0	12.0	12	22	110
G8D62160	R8.0	16.0	16	30	140
G8D62200	R10.0	20.0	20	38	160

Due to the characteristics of the blue decoration layer, it might be erased during short term use and the color layer might not be uniformed. However, it doesn't affect the performance of the tool.

Size	Radius Tolerance (mm)	Mill Dia. Tolerance (mm)	Shank Dia. Tolerance
up to R3	± 0.005	0 ~ - 0.012	h5
over R3	± 0.010	0 ~ - 0.015	

◎ : Excellent ○ : Good

ISO	P										M				K					
	Non-alloy steel					Low alloy steel					High alloyed steel, and tool steel		Stainless steel		Grey cast iron		Nodular cast iron		Malleable cast iron	
Material Description	1	2	3	4	5	6	7	8	9	10	11	12	13	14	15	16	17	18	19	20
VDI 3323	1	2	3	4	5	6	7	8	9	10	11	12	13	14	15	16	17	18	19	20
HRc	13	25	28	32	30	29	32	38	35	35	35	15	23	10	10	26	3	25	21	21
HB	125	190	250	270	300	180	275	300	350	200	325	200	240	180	180	260	160	250	130	230
Recommend	○										○				○					

ISO	N					S					H										
	Aluminum-wrought alloy		Aluminum-cast, alloyed		Copper and Copper Alloys (Bronze / Brass)	Non Metallic Materials	Heat Resistant Super Alloys				Titanium Alloys		Hardened steel	Chilled Cast Iron	Hardened Cast Iron						
Material Description	21	22	23	24	25	26	27	28	29	30	31	32	33	34	35	36	37	38	39	40	41
VDI 3323	21	22	23	24	25	26	27	28	29	30	31	32	33	34	35	36	37	38	39	40	41
HRc	21	22	23	24	25	26	27	28	29	30	15	30	25	38	34	55	60	42	55	55	55
HB	60	100	75	90	130	110	90	100			200	280	250	350	320	400 Rm	1050 Rm	550	630	400	550
Recommend	◎					◎					◎				◎						



PLAIN SHANK **G8A60** SERIES

CARBIDE, 2 FLUTE CORNER RADIUS for RIB PROCESSING

- **VOLLHARTMETALL, 2 SCHNEIDEN ECKENRADIUS für SCHMALE RIPPEN**
- **Fraise carbure, 2 dents, torique pour usinage de rainure**
- **2 TAGLIENTI, TORICA, SCARICATA PER ENRVATURE**

- ▶ Designed to machine high hardened materials.
- ▶ Suitable for dry cutting, high speed cutting thanks to newly developed raw-material and new coating.
- ▶ Excellent workpiece finish.
- ▶ Deep slotting is possible by reduced neck.
- ▶ Corner radius for preventing the chipping in high speed machining.
- ▶ Higher wear-resistance.

- ▶ Geeignet zum Fräsen hochgehärteter Stähle.
- ▶ Geeignet zum Trockenfräsen und HSC-Fräsen dank neuentwickeltem Material und Beschichtung.
- ▶ Excellente Werkstückoberflächen.
- ▶ Abgesetzter Schaft für größere Reichweite.
- ▶ Schneidkantenschutz durch definierten Radius.
- ▶ Höhere Verschleißfestigkeit.



Plain Shank	Page
HYDRAULIC CHUCK SHRINK FIT HOLDER	D15-46 D47-72
POWER MILLING CHUCK	D161-176
ER COLLET CHUCK SK SLIM CHUCK	D73-116 D183-201



Unit : mm

EDP No.	Corner Radius	Mill Diameter	Shank Diameter	Length of Cut	Length Below Shank	Overall Length	Neck Diameter
	R	D1	D2	L1	L3	L2	D3
G8A60936	R0.05	0.5	4	0.7	1.5	45	0.45
G8A60932	R0.05	0.5	4	0.7	2.5	45	0.45
G8A60935	R0.05	0.5	4	0.7	4	45	0.45
G8A60931	R0.05	0.6	4	0.9	2	45	0.55
G8A60933	R0.05	0.6	4	0.9	3	45	0.55
G8A60934	R0.05	0.6	4	0.9	4	45	0.55
G8A600060102	R0.1	0.6	4	0.9	2	45	0.55
G8A600070104	R0.1	0.7	4	1	4	45	0.65
G8A600080102	R0.1	0.8	4	1.2	2	45	0.75
G8A60008	R0.1	0.8	4	1.2	4	45	0.75
G8A60924	R0.1	0.8	4	1.2	6	45	0.75
G8A609254S	R0.1	1.0	4	1.5	4	50	0.95
G8A609264S	R0.1	1.0	4	1.5	6	50	0.95
G8A600100204	R0.2	1.0	4	1.5	4	50	0.95
G8A600100206	R0.2	1.0	4	1.5	6	50	0.95
G8A609114S	R0.2	1.0	4	1.5	8	50	0.95
G8A600100304	R0.3	1.0	4	1.5	4	50	0.95
G8A600100306	R0.3	1.0	4	1.5	6	50	0.95
G8A60980	R0.3	1.0	4	1.5	8	50	0.95
G8A60925	R0.1	1.0	6	1.5	4	50	0.95
G8A60926	R0.1	1.0	6	1.5	6	50	0.95
G8A60010	R0.2	1.0	6	1.5	4	50	0.95

Due to the characteristics of the blue decoration layer, it might be erased during short term use and the color layer might not be uniformed. However, it doesn't affect the performance of the tool. ▶ NEXT PAGE

Size	Corner Radius Tolerance (mm)	Mill Dia. Tolerance (mm)	Shank Dia. Tolerance
up to Ø6	± 0.010	0 ~ - 0.012	h5
over Ø6	± 0.015	0 ~ - 0.015	

◎ : Excellent ○ : Good

ISO	P										M				K					
	Non-alloy steel					Low alloy steel					High alloyed steel, and tool steel		Stainless steel		Grey cast iron	Nodular cast iron		Malleable cast iron		
Material Description	1	2	3	4	5	6	7	8	9	10	11	12	13	14	15	16	17	18	19	20
VDI 3323	1	2	3	4	5	6	7	8	9	10	11	12	13	14	15	16	17	18	19	20
HRc	125	13	25	28	32	10	29	32	38	15	35	15	23	10	10	26	3	25	21	21
HB	125	190	250	270	300	180	275	300	350	200	325	200	240	180	180	260	160	250	130	230
Recommend	○										○		○			○				

ISO	N					S					H										
	Aluminum-wrought alloy		Aluminum-cast, alloyed		Copper and Copper Alloys (Bronze / Brass)	Non Metallic Materials		Heat Resistant Super Alloys			Titanium Alloys		Hardened steel	Chilled Cast Iron	Hardened Cast Iron						
Material Description	21	22	23	24	25	26	27	28	29	30	31	32	33	34	35	36	37	38	39	40	41
VDI 3323	21	22	23	24	25	26	27	28	29	30	31	32	33	34	35	36	37	38	39	40	41
HRc	60	100	75	90	130	110	90	100			15	30	25	38	34			55	60	42	55
HB	60	100	75	90	130	110	90	100			200	280	250	350	320	400 Rm	1050 Rm	550	630	400	550
Recommend	◎		◎		◎		◎		◎			◎		◎		◎		◎		◎	



PLAIN SHANK **G8A60** SERIES

CARBIDE, 2 FLUTE CORNER RADIUS for RIB PROCESSING

- **VOLLHARTMETALL, 2 SCHNEIDEN ECKENRADIUS für SCHMALE RIPPEN**
- **Fraise carbure, 2 dents, torique pour usinage de rainure**
- **2 TAGLIENTI, TORICA, SCARICATA PER ENRVATURE**

- ▶ Designed to machine high hardened materials.
- ▶ Suitable for dry cutting, high speed cutting thanks to newly developed raw-material and new coating.
- ▶ Excellent workpiece finish.
- ▶ Deep slotting is possible by reduced neck.
- ▶ Corner radius for preventing the chipping in high speed machining.
- ▶ Higher wear-resistance.

- ▶ Geeignet zum Fräsen hochgehärteter Stähle.
- ▶ Geeignet zum Trockenfräsen und HSC-Fräsen dank neuentwickeltem Material und Beschichtung.
- ▶ Excellente Werkstückoberflächen.
- ▶ Abgesetzter Schaft für größere Reichweite.
- ▶ Schneidkantenschutz durch definierten Radius.
- ▶ Höhere Verschleißfestigkeit.

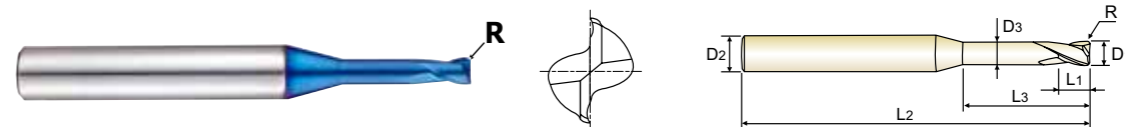

Plain Shank	Page
HYDRAULIC CHUCK SHRINK FIT HOLDER	D15-46 D47-72
POWER MILLING CHUCK	D161-176
ER COLLET CHUCK SK SLIM CHUCK	D73-116 D183-201



Unit : mm

EDP No.	Corner Radius	Mill Diameter	Shank Diameter	Length of Cut	Length Below Shank	Overall Length	Neck Diameter
	R	D1	D2	L1	L3	L2	D3
G8A60910	R0.2	1.0	6	1.5	6	50	0.95
G8A60911	R0.2	1.0	6	1.5	8	50	0.95
G8A60912	R0.3	1.0	6	1.5	4	50	0.95
G8A60930	R0.3	1.0	6	1.5	6	50	0.95
G8A600100308	R0.3	1.0	6	1.5	8	50	0.95
G8A600154S	R0.2	1.5	4	2.5	4	50	1.45
G8A6001502064S	R0.2	1.5	4	2.5	6	50	1.45
G8A6001502084S	R0.2	1.5	4	2.5	8	50	1.45
G8A609134S	R0.2	1.5	4	2.5	10	50	1.45
G8A609144S	R0.2	1.5	4	2.5	12	50	1.45
G8A609154S	R0.3	1.5	4	2.5	4	50	1.45
G8A6001503064S	R0.3	1.5	4	2.5	6	50	1.45
G8A6001503084S	R0.3	1.5	4	2.5	8	50	1.45
G8A60015	R0.2	1.5	6	2.5	4	50	1.45
G8A600150206	R0.2	1.5	6	2.5	6	50	1.45
G8A600150208	R0.2	1.5	6	2.5	8	50	1.45
G8A60913	R0.2	1.5	6	2.5	10	50	1.45
G8A60914	R0.2	1.5	6	2.5	12	50	1.45
G8A60915	R0.3	1.5	6	2.5	4	50	1.45
G8A600150306	R0.3	1.5	6	2.5	6	50	1.45
G8A600150308	R0.3	1.5	6	2.5	8	50	1.45
G8A609274S	R0.2	2.0	4	3	6	50	1.95

Due to the characteristics of the blue decoration layer, it might be erased during short term use and the color layer might not be uniformed. However, it doesn't affect the performance of the tool. ▶ NEXT PAGE

Size	Corner Radius Tolerance (mm)	Mill Dia. Tolerance (mm)	Shank Dia. Tolerance
up to Ø6	± 0.010	0 ~ - 0.012	h5
over Ø6	± 0.015	0 ~ - 0.015	

◎ : Excellent ○ : Good

ISO	P										M				K					
	Non-alloy steel					Low alloy steel					High alloyed steel, and tool steel		Stainless steel		Grey cast iron	Nodular cast iron		Malleable cast iron		
Material Description	1	2	3	4	5	6	7	8	9	10	11	12	13	14	15	16	17	18	19	20
VDI 3323	1	2	3	4	5	6	7	8	9	10	11	12	13	14	15	16	17	18	19	20
HRc	125	13	25	28	32	10	29	32	38	15	35	15	23	10	10	26	3	25	21	21
HB	125	190	250	270	300	180	275	300	350	200	325	200	240	180	180	260	160	250	130	230
Recommend	○										○		○			○				

ISO	N					S					H										
	Aluminum-wrought alloy		Aluminum-cast, alloyed		Copper and Copper Alloys (Bronze / Brass)	Non Metallic Materials		Heat Resistant Super Alloys			Titanium Alloys		Hardened steel	Chilled Cast Iron	Hardened Cast Iron						
Material Description	21	22	23	24	25	26	27	28	29	30	31	32	33	34	35	36	37	38	39	40	41
VDI 3323	21	22	23	24	25	26	27	28	29	30	31	32	33	34	35	36	37	38	39	40	41
HRc	60	100	75	90	130	110	90	100			15	30	25	38	34			55	60	42	55
HB	60	100	75	90	130	110	90	100			200	280	250	350	320	400 Rm	1050 Rm	550	630	400	550
Recommend	◎		◎		◎		◎		◎			◎		◎		◎		◎		◎	

CARBIDE, 2 FLUTE CORNER RADIUS for RIB PROCESSING

- **VOLLHARTMETALL, 2 SCHNEIDEN ECKENRADIUS für SCHMALE RIPPEN**
- **Fraise carbure, 2 dents, torique pour usinage de rainure**
- **2 TAGLIENTI, TORICA, SCARICATA PER ENRVATURE**

- ▶ Designed to machine high hardened materials.
- ▶ Suitable for dry cutting, high speed cutting thanks to newly developed raw-material and new coating.
- ▶ Excellent workpiece finish.
- ▶ Deep slotting is possible by reduced neck.
- ▶ Corner radius for preventing the chipping in high speed machining.
- ▶ Higher wear-resistance.

- ▶ Geeignet zum Fräsen hochgehärteter Stähle.
- ▶ Geeignet zum Trockenfräsen und HSC-Fräsen dank neuentwickeltem Material und Beschichtung.
- ▶ Excellente Werkstückoberflächen.
- ▶ Abgesetzter Schaft für größere Reichweite.
- ▶ Schneidkantenschutz durch definierten Radius.
- ▶ Höhere Verschleißfestigkeit.



CARBIDE 2 30° ±0.010 ±0.015 PLAIN BLUE p.C130-131

Plain Shank	Page
HYDRAULIC CHUCK SHRINK FIT HOLDER	D15-46 D47-72
POWER MILLING CHUCK	D161-176
ER COLLET CHUCK SK SLIM CHUCK	D73-116 D183-201

Unit : mm

EDP No.	Corner Radius	Mill Diameter	Shank Diameter	Length of Cut	Length Below Shank	Overall Length	Neck Diameter
	R	D1	D2	L1	L3	L2	D3
G8A6002002084S	R0.2	2.0	4	3	8	50	1.95
G8A6002002104S	R0.2	2.0	4	3	10	55	1.95
G8A6002002124S	R0.2	2.0	4	3	12	55	1.95
G8A609164S	R0.3	2.0	4	3	6	50	1.95
G8A6002003084S	R0.3	2.0	4	3	8	50	1.95
G8A6002003104S	R0.3	2.0	4	3	10	55	1.95
G8A6002003124S	R0.3	2.0	4	3	12	55	1.95
G8A6002003164S	R0.3	2.0	4	3	16	55	1.95
G8A609174S	R0.5	2.0	4	3	6	50	1.95
G8A600204S	R0.5	2.0	4	3	10	55	1.95
G8A609184S	R0.5	2.0	4	3	12	55	1.95
G8A60927	R0.2	2.0	6	3	6	50	1.95
G8A600200208	R0.2	2.0	6	3	8	50	1.95
G8A600200210	R0.2	2.0	6	3	10	55	1.95
G8A600200212	R0.2	2.0	6	3	12	55	1.95
G8A60916	R0.3	2.0	6	3	6	50	1.95
G8A600200308	R0.3	2.0	6	3	8	50	1.95
G8A600200310	R0.3	2.0	6	3	10	55	1.95
G8A600200312	R0.3	2.0	6	3	12	55	1.95
G8A600200316	R0.3	2.0	6	3	16	55	1.95
G8A60917	R0.5	2.0	6	3	6	50	1.95
G8A60020	R0.5	2.0	6	3	10	55	1.95

Due to the characteristics of the blue decoration layer, it might be erased during short term use and the color layer might not be uniformed. However, it doesn't affect the performance of the tool. ▶ NEXT PAGE

Size	Corner Radius Tolerance (mm)	Mill Dia. Tolerance (mm)	Shank Dia. Tolerance
up to Ø6	± 0.010	0 ~ - 0.012	h5
over Ø6	± 0.015	0 ~ - 0.015	

◎ : Excellent ○ : Good

ISO	P										M				K						
	Non-alloy steel					Low alloy steel					High alloyed steel, and tool steel		Stainless steel		Grey cast iron	Nodular cast iron		Malleable cast iron			
Material Description	1	2	3	4	5	6	7	8	9	10	11	12	13	14	15	16	17	18	19	20	
VDI 3323	1	2	3	4	5	6	7	8	9	10	11	12	13	14	15	16	17	18	19	20	
HRc	13	25	28	32	32	10	29	32	38	15	35	15	23	10	10	26	3	25	21	21	
HB	125	190	250	270	300	180	275	300	350	200	325	200	240	180	180	260	160	250	130	230	
Recommend					○				○												

ISO	N					S					H										
	Aluminum-wrought alloy		Aluminum-cast, alloyed		Copper and Copper Alloys (Bronze / Brass)	Non Metallic Materials		Heat Resistant Super Alloys			Titanium Alloys		Hardened steel	Chilled Cast Iron	Hardened Cast Iron						
Material Description	21	22	23	24	25	26	27	28	29	30	31	32	33	34	35	36	37	38	39	40	41
VDI 3323	21	22	23	24	25	26	27	28	29	30	31	32	33	34	35	36	37	38	39	40	41
HRc	21	22	23	24	25	26	27	28	29	30	31	32	33	34	35	36	37	38	39	40	41
HB	60	100	75	90	130	110	90	100			200	280	250	350	320	400 Rm	1050 Rm	550	630	400	550
Recommend																		◎	◎	○	◎

CARBIDE, 2 FLUTE CORNER RADIUS for RIB PROCESSING

- **VOLLHARTMETALL, 2 SCHNEIDEN ECKENRADIUS für SCHMALE RIPPEN**
- **Fraise carbure, 2 dents, torique pour usinage de rainure**
- **2 TAGLIENTI, TORICA, SCARICATA PER ENRVATURE**

- ▶ Designed to machine high hardened materials.
- ▶ Suitable for dry cutting, high speed cutting thanks to newly developed raw-material and new coating.
- ▶ Excellent workpiece finish.
- ▶ Deep slotting is possible by reduced neck.
- ▶ Corner radius for preventing the chipping in high speed machining.
- ▶ Higher wear-resistance.

- ▶ Geeignet zum Fräsen hochgehärteter Stähle.
- ▶ Geeignet zum Trockenfräsen und HSC-Fräsen dank neuentwickeltem Material und Beschichtung.
- ▶ Excellente Werkstückoberflächen.
- ▶ Abgesetzter Schaft für größere Reichweite.
- ▶ Schneidkantenschutz durch definierten Radius.
- ▶ Höhere Verschleißfestigkeit.



CARBIDE 2 30° ±0.010 ±0.015 PLAIN BLUE p.C130-131

Plain Shank	Page
HYDRAULIC CHUCK SHRINK FIT HOLDER	D15-46 D47-72
POWER MILLING CHUCK	D161-176
ER COLLET CHUCK SK SLIM CHUCK	D73-116 D183-201

Unit : mm

EDP No.	Corner Radius	Mill Diameter	Shank Diameter	Length of Cut	Length Below Shank	Overall Length	Neck Diameter
	R	D1	D2	L1	L3	L2	D3
G8A60918	R0.5	2.0	6	3	12	55	1.95
G8A600300208	R0.2	3.0	6	4	8	55	2.85
G8A600300210	R0.2	3.0	6	4	10	55	2.85
G8A600300212	R0.2	3.0	6	4	12	55	2.85
G8A600300216	R0.2	3.0	6	4	16	55	2.85
G8A600300308	R0.3	3.0	6	4	8	55	2.85
G8A60919	R0.3	3.0	6	4	10	55	2.85
G8A600300312	R0.3	3.0	6	4	12	55	2.85
G8A600300316	R0.3	3.0	6	4	16	55	2.85
G8A60030	R0.5	3.0	6	4	10	55	2.85
G8A600300512	R0.5	3.0	6	4	12	55	2.85
G8A60901	R0.5	3.0	6	4	16	55	2.85
G8A60902	R0.5	3.0	6	4	20	55	2.85
G8A600400212	R0.2	4.0	6	5	12	55	3.85
G8A600400216	R0.2	4.0	6	5	16	55	3.85
G8A600400220	R0.2	4.0	6	5	20	55	3.85
G8A600400310	R0.3	4.0	6	5	10	55	3.85
G8A60920	R0.3	4.0	6	5	12	55	3.85
G8A600400316	R0.3	4.0	6	5	16	55	3.85
G8A600400320	R0.3	4.0	6	5	20	55	3.85
G8A60040	R0.5	4.0	6	5	12	55	3.85
G8A60903	R0.5	4.0	6	5	16	55	3.85

Due to the characteristics of the blue decoration layer, it might be erased during short term use and the color layer might not be uniformed. However, it doesn't affect the performance of the tool. ▶ NEXT PAGE

Size	Corner Radius Tolerance (mm)	Mill Dia. Tolerance (mm)	Shank Dia. Tolerance
up to Ø6	± 0.010	0 ~ - 0.012	h5
over Ø6	± 0.015	0 ~ - 0.015	

◎ : Excellent ○ : Good

ISO	P										M				K						
	Non-alloy steel					Low alloy steel					High alloyed steel, and tool steel		Stainless steel		Grey cast iron	Nodular cast iron		Malleable cast iron			
Material Description	1	2	3	4	5	6	7	8	9	10	11	12	13	14	15	16	17	18	19	20	
VDI 3323	1	2	3	4	5	6	7	8	9	10	11	12	13	14	15	16	17	18	19	20	
HRc	13	25	28	32	32	10	29	32	38	15	35	15	23	10	10	26	3	25	21	21	
HB	125	190	250	270	300	180	275	300	350	200	325	200	240	180	180	260	160	250	130	230	
Recommend					○				○												

ISO	N					S					H										
	Aluminum-wrought alloy		Aluminum-cast, alloyed		Copper and Copper Alloys (Bronze / Brass)	Non Metallic Materials		Heat Resistant Super Alloys			Titanium Alloys		Hardened steel	Chilled Cast Iron	Hardened Cast Iron						
Material Description	21	22	23	24	25	26	27	28	29	30	31	32	33	34	35	36	37	38	39	40	41
VDI 3323	21	22	23	24	25	26	27	28	29	30	31	32	33	34	35	36	37	38	39	40	41
HRc	21	22	23	24	25	26	27	28	29	30	31	32	33	34	35	36	37	38	39	40	41
HB	60	100	75	90	130	110	90	100			200	280	250	350	320	400 Rm	1050 Rm	550	630	400	550
Recommend																		◎	◎	○	◎



PLAIN SHANK **G8A60** SERIES

CARBIDE, 2 FLUTE CORNER RADIUS for RIB PROCESSING

- VOLLHARTMETALL, 2 SCHNEIDEN ECKENRADIUS für SCHMALE RIPPEN
- ① Fraise carbure, 2 dents, torique pour usinage de rainure
- ② 2 TAGLIENTI, TORICA, SCARICATA PER ENRVATURE

- ▶ Designed to machine high hardened materials.
- ▶ Suitable for dry cutting, high speed cutting thanks to newly developed raw-material and new coating.
- ▶ Excellent workpiece finish.
- ▶ Deep slotting is possible by reduced neck.
- ▶ Corner radius for preventing the chipping in high speed machining.
- ▶ Higher wear-resistance.

- ▶ Geeignet zum Fräsen hochgehärteter Stähle.
- ▶ Geeignet zum Trockenfräsen und HSC-Fräsen dank neuentwickeltem Material und Beschichtung.
- ▶ Excellente Werkstückoberflächen.
- ▶ Abgesetzter Schaft für größere Reichweite.
- ▶ Schneidkantenschutz durch definierten Radius.
- ▶ Höhere Verschleißfestigkeit.

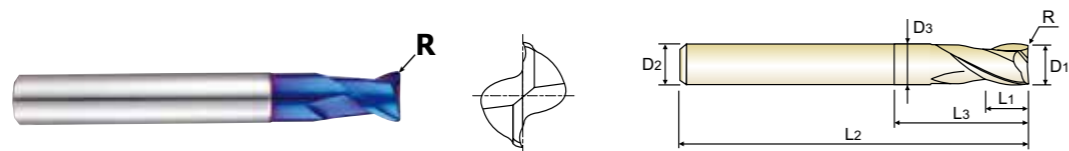

CARBIDE 2 30° ±0.010 ±0.015 PLAIN BLUE p.C130-131

EDP No.	Corner Radius	Mill Diameter	Shank Diameter	Length of Cut	Length Below Shank	Overall Length	Neck Diameter
	R	D1	D2	L1	L3	L2	D3
G8A60904	R0.5	4.0	6	5	20	55	3.85
G8A600401012	R1.0	4.0	6	5	12	55	3.85
G8A600401016	R1.0	4.0	6	5	16	55	3.85
G8A60921	R0.3	6.0	6	7	20	60	5.85
G8A60060	R0.5	6.0	6	7	20	60	5.85
G8A60905	R1.0	6.0	6	7	20	60	5.85
G8A60906	R1.5	6.0	6	7	20	60	5.85
G8A600602020	R2.0	6.0	6	7	20	60	5.85
G8A60922	R0.3	8.0	8	9	25	60	7.7
G8A60929	R0.5	8.0	8	9	25	60	7.7
G8A60080	R1.0	8.0	8	9	25	60	7.7
G8A60907	R1.5	8.0	8	9	25	60	7.7
G8A600802025	R2.0	8.0	8	9	25	60	7.7
G8A60923	R0.3	10.0	10	11	32	70	9.7
G8A601000532	R0.5	10.0	10	11	32	70	9.7
G8A60100	R1.0	10.0	10	11	32	70	9.7
G8A60908	R1.5	10.0	10	11	32	70	9.7
G8A601002032	R2.0	10.0	10	11	32	70	9.7
G8A601200538	R0.5	12.0	12	12	38	80	11.7
G8A60120	R1.0	12.0	12	12	38	80	11.7
G8A60909	R1.5	12.0	12	12	38	80	11.7
G8A601202038	R2.0	12.0	12	12	38	80	11.7

Due to the characteristics of the blue decoration layer, it might be erased during short term use and the color layer might not be uniformed. However, it doesn't affect the performance of the tool.

Size	Corner Radius Tolerance (mm)	Mill Dia. Tolerance (mm)	Shank Dia. Tolerance
up to Ø6	± 0.010	0 ~ - 0.012	h5
over Ø6	± 0.015	0 ~ - 0.015	

◎ : Excellent ○ : Good

ISO	P										M				K					
	Non-alloy steel					Low alloy steel					High alloyed steel, and tool steel		Stainless steel		Grey cast iron	Nodular cast iron		Malleable cast iron		
Material Description	1	2	3	4	5	6	7	8	9	10	11	12	13	14	15	16	17	18	19	20
VDI 3323	1	2	3	4	5	6	7	8	9	10	11	12	13	14	15	16	17	18	19	20
HRc	125	13	25	28	32	10	29	32	38	15	35	15	23	10	10	26	3	25	21	21
HB	125	190	250	270	300	180	275	300	350	200	325	200	240	180	180	260	160	250	130	230
Recommend	○										○				○					

ISO	N					S					H											
	Aluminum-wrought alloy		Aluminum-cast, alloyed		Copper and Copper Alloys (Bronze / Brass)	Heat Resistant Super Alloys		Titanium Alloys		Hardened steel	Chilled Cast Iron	Hardened Cast Iron										
Material Description	21	22	23	24	25	26	27	28	29	30	31	32	33	34	35	36	37	38	39	40	41	
VDI 3323	21	22	23	24	25	26	27	28	29	30	31	32	33	34	35	36	37	38	39	40	41	
HRc	60	100	75	90	130	110	90	100			15	30	25	38	34	400 Rm	1050 Rm	550	630	400	550	
HB	60	100	75	90	130	110	90	100			200	280	250	350	320	400 Rm	1050 Rm	550	630	400	550	
Recommend	◎		◎		◎	◎		◎		◎	◎	◎	◎	◎	◎	◎	◎	◎	◎	◎	◎	◎



PLAIN SHANK **G8A36** SERIES

CARBIDE, 2 FLUTE STUB LENGTH CORNER RADIUS with EXTENDED NECK

- VOLLHARTMETALL, 2 SCHNEIDEN EXTRA KURZ ECKENRADIUS mit ABGESETZTEM SCHAFTTEIL
- ① Fraise carbure, 2 dents, torique, détalonnée, extra-courte
- ② 2 TAGLIENTI, TORICA, TAGLIENTE CORTO CON SARICO ESTESO

- ▶ Designed to machine high hardened materials.
- ▶ Suitable for dry cutting, high speed cutting thanks to newly developed raw-material and new coating.
- ▶ Excellent workpiece finish.
- ▶ Deep slotting is possible by reduced neck.
- ▶ Corner radius for preventing the chipping in high speed machining.
- ▶ Higher wear-resistance.

- ▶ Geeignet zum Fräsen hochgehärteter Stähle.
- ▶ Geeignet zum Trockenfräsen und HSC-Fräsen dank neuentwickeltem Material und Beschichtung.
- ▶ Excellente Werkstückoberflächen.
- ▶ Abgesetzter Schaft für größere Reichweite.
- ▶ Schneidkantenschutz durch definierten Radius.
- ▶ Höhere Verschleißfestigkeit.

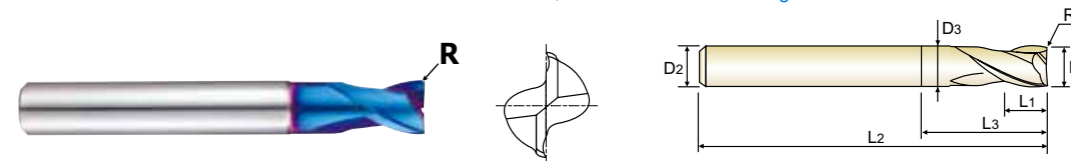

CARBIDE 2 30° ±0.010 ±0.015 PLAIN BLUE p.C137-139

EDP No.	Corner Radius	Mill Diameter	Shank Diameter	Length of Cut	Length Below Shank	Overall Length	Neck Diameter
	R	D1	D2	L1	L3	L2	D3
G8A36003	-	0.3	3	0.45	-	40	-
G8A36004	-	0.4	3	0.6	-	40	-
G8A36005	R0.05	0.5	3	0.7	-	40	-
G8A36907	R0.05	0.5	4	1	-	40	-
G8A36006	R0.05	0.6	3	0.9	-	40	-
G8A36908	R0.05	0.6	4	1.2	-	40	-
G8A36909	R0.05	0.7	4	1.4	-	40	-
G8A36008	R0.05	0.8	3	1.2	-	40	-
G8A36910	R0.05	0.8	4	1.6	-	40	-
G8A36911	R0.05	0.9	4	2	-	40	-
G8A36010	R0.1	1.0	3	1.5	-	40	-
G8A36901	R0.1	1.0	4	1.5	-	40	-
G8A36903	R0.1	1.0	6	1.5	-	40	-
G8A36015	R0.1	1.5	3	2.2	-	40	-
G8A36904	R0.1	1.5	6	2.2	-	40	-
G8A36020	R0.1	2.0	3	3	6	40	1.95
G8A36902	R0.1	2.0	4	3	6	40	1.95
G8A36905	R0.1	2.0	6	3	6	40	1.95
G8A36025	R0.1	2.5	3	4	6	40	2.4
G8A36906	R0.1	2.5	6	4	6	40	2.4
G8A36030	R0.1	3.0	6	4	7	45	2.85
G8A36035	R0.1	3.5	6	5	9	45	3.35

Due to the characteristics of the blue decoration layer, it might be erased during short term use and the color layer might not be uniformed. However, it doesn't affect the performance of the tool. ▶ NEXT PAGE

Size	Corner Radius Tolerance (mm)	Mill Dia. Tolerance (mm)	Shank Dia. Tolerance
up to Ø6	± 0.010	0 ~ - 0.012	h5
over Ø6	± 0.015	0 ~ - 0.015	

◎ : Excellent ○ : Good

ISO	P										M				K					
	Non-alloy steel					Low alloy steel					High alloyed steel, and tool steel		Stainless steel		Grey cast iron	Nodular cast iron		Malleable cast iron		
Material Description	1	2	3	4	5	6	7	8	9	10	11	12	13	14	15	16	17	18	19	20
VDI 3323	1	2	3	4	5	6	7	8	9	10	11	12	13	14	15	16	17	18	19	20
HRc	125	13	25	28	32	10	29	32	38	15	35	15	23	10	10	26	3	25	21	21
HB	125	190	250	270	300	180	275	300	350	200	325	200	240	180	180	260	160	250	130	230
Recommend	○										○				○					

ISO	N					S					H											
	Aluminum-wrought alloy		Aluminum-cast, alloyed		Copper and Copper Alloys (Bronze / Brass)	Heat Resistant Super Alloys		Titanium Alloys		Hardened steel	Chilled Cast Iron	Hardened Cast Iron										
Material Description	21	22	23	24	25	26	27	28	29	30	31	32	33	34	35	36	37	38	39	40	41	
VDI 3323	21	22	23	24	25	26	27	28	29	30	31	32	33	34	35	36	37	38	39	40	41	
HRc	60	100	75	90	130	110	90	100			15	30	25	38	34	400 Rm	1050 Rm	550	630	400	550	
HB	60	100	75	90	130	110	90	100			200	280	250	350	320	400 Rm	1050 Rm	550	630	400	550	
Recommend	◎		◎		◎	◎		◎		◎	◎	◎	◎	◎	◎	◎	◎	◎	◎	◎	◎	◎



PLAIN SHANK **G8A36** SERIES

CARBIDE, 2 FLUTE STUB LENGTH CORNER RADIUS with EXTENDED NECK

- VOLLHARTMETALL, 2 SCHNEIDEN EXTRA KURZ ECKENRADIUS mit ABGESETZTEM SCHAFTTEIL
- ① Fraise carbure, 2 dents, torique, détalonnée, extra-courte
- ② 2 TAGLIENTI, TORICA, TAGLIENTE CORTO CON SARICO ESTESO

- ▶ Designed to machine high hardened materials.
- ▶ Suitable for dry cutting, high speed cutting thanks to newly developed raw-material and new coating.
- ▶ Excellent workpiece finish.
- ▶ Deep slotting is possible by reduced neck.
- ▶ Corner radius for preventing the chipping in high speed machining.
- ▶ Higher wear-resistance.

- ▶ Geeignet zum Fräsen hochgehärteter Stähle.
- ▶ Geeignet zum Trockenfräsen und HSC-Fräsen dank neuentwickeltem Material und Beschichtung.
- ▶ Excellente Werkstückoberflächen.
- ▶ Abgesetzter Schaft für größere Reichweite.
- ▶ Schneidkantenschutz durch definierten Radius.
- ▶ Höhere Verschleißfestigkeit.

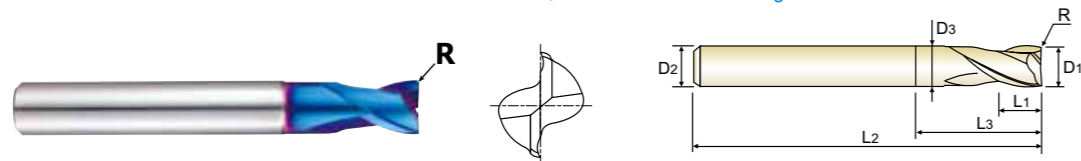

CARBIDE 2 30° ±0.010 ±0.015 PLAIN BLUE p.C137-139

EDP No.	Corner Radius	Mill Diameter	Shank Diameter	Length of Cut	Length Below Shank	Overall Length	Neck Diameter
	R	D1	D2	L1	L3	L2	D3
G8A36040	R0.1	4.0	6	5	9	45	3.85
G8A36045	R0.1	4.5	6	6	10	45	4.35
G8A36050	R0.2	5.0	6	6	11	50	4.85
G8A36060	R0.2	6.0	6	7	14	50	5.85
G8A36080	R0.2	8.0	8	9	18	60	7.7
G8A36100	R0.2	10.0	10	12	25	75	9.7
G8A36120	R0.3	12.0	12	15	30	75	11.7
G8A36160	R0.3	16.0	16	18	38	90	15.7
G8A36200	R0.3	20.0	20	24	45	100	19.7

Due to the characteristics of the blue decoration layer, it might be erased during short term use and the color layer might not be uniformed. However, it doesn't affect the performance of the tool.

Size	Corner Radius Tolerance (mm)	Mill Dia. Tolerance (mm)	Shank Dia. Tolerance
up to Ø6	± 0.010	0 ~ - 0.012	h5
over Ø6	± 0.015	0 ~ - 0.015	

◎ : Excellent ○ : Good

ISO Material Description	P										M				K					
	Non-alloy steel					Low alloy steel					High alloyed steel, and tool steel		Stainless steel		Grey cast iron		Nodular cast iron		Malleable cast iron	
VDI 3323	1	2	3	4	5	6	7	8	9	10	11	12	13	14	15	16	17	18	19	20
HRc	13	25	28	32	32	10	29	32	38	15	35	15	23	10	10	26	3	25	21	23
HB	125	190	250	270	300	180	275	300	350	200	325	200	240	180	180	260	160	250	130	230
Recommend	○										○		○		○		○		○	

ISO Material Description	N										S						H				
	Aluminum-wrought alloy		Aluminum-cast, alloyed			Copper and Copper Alloys (Bronze / Brass)			Non Metallic Materials		Heat Resistant Super Alloys				Titanium Alloys		Hardened steel	Chilled Cast Iron	Hardened Cast Iron		
VDI 3323	21	22	23	24	25	26	27	28	29	30	31	32	33	34	35	36	37	38	39	40	41
HRc	15	30	25	38	34						15	30	25	38	34			55	60	42	55
HB	60	100	75	90	130	110	90	100			200	280	250	350	320	400 Rm	1050 Rm	550	630	400	550
Recommend	◎										◎						◎				



PLAIN SHANK **G8A52** SERIES

CARBIDE, 2 FLUTE CORNER RADIUS for RIB PROCESSING

- VOLLHARTMETALL, 2 SCHNEIDEN ECKENRADIUS für SCHMALE RIPPEN
- ① Fraise carbure, 2 dents, torique pour usinage de rainure
- ② 2 TAGLIENTI, TORICA, SCARIATA PER NERVATURE

- ▶ Designed to machine high hardened materials.
- ▶ Suitable for dry cutting, high speed cutting thanks to newly developed raw-material and new coating.
- ▶ Excellent workpiece finish.
- ▶ Deep slotting is possible by reduced neck.
- ▶ Corner radius for preventing the chipping in high speed machining.
- ▶ Higher wear-resistance.

- ▶ Geeignet zum Fräsen hochgehärteter Stähle.
- ▶ Geeignet zum Trockenfräsen und HSC-Fräsen dank neuentwickeltem Material und Beschichtung.
- ▶ Excellente Werkstückoberflächen.
- ▶ Abgesetzter Schaft für größere Reichweite.
- ▶ Schneidkantenschutz durch definierten Radius.
- ▶ Höhere Verschleißfestigkeit.

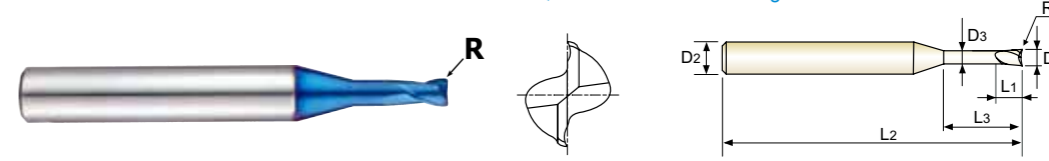

CARBIDE 2 30° ±0.010 PLAIN BLUE p.C132

EDP No.	Corner Radius	Mill Diameter	Shank Diameter	Length of Cut	Length Below Shank	Overall Length	Neck Diameter
	R (±0.010)	D1	D2	L1	L3	L2	D3
G8A52005	R0.05	0.5	6	0.7	1.5	50	0.45
G8A52901	R0.05	0.5	6	0.7	3.3	50	0.45
G8A52006	R0.05	0.6	6	0.9	2	50	0.55
G8A52902	R0.05	0.6	6	0.9	4	50	0.55
G8A52008	R0.05	0.8	6	1.2	2.5	50	0.75
G8A52903	R0.05	0.8	6	1.2	5.5	50	0.75
G8A52010	R0.10	1.0	6	1.5	3.3	50	0.95
G8A52904	R0.10	1.0	6	1.5	6.7	50	0.95
G8A52012	R0.10	1.2	6	1.8	4.4	50	1.15
G8A52905	R0.10	1.2	6	1.8	8	50	1.15
G8A52015	R0.15	1.5	6	2.2	5	50	1.45
G8A52906	R0.15	1.5	6	2.2	9.7	50	1.45
G8A52020	R0.15	2.0	6	2.2	6	50	1.95
G8A52907	R0.15	2.0	6	2.2	13	50	1.95

Due to the characteristics of the blue decoration layer, it might be erased during short term use and the color layer might not be uniformed. However, it doesn't affect the performance of the tool.

Mill Dia. Tolerance (mm)	Shank Dia. Tolerance
0 ~ - 0.012	h5

◎ : Excellent ○ : Good

ISO Material Description	P										M				K					
	Non-alloy steel					Low alloy steel					High alloyed steel, and tool steel		Stainless steel		Grey cast iron		Nodular cast iron		Malleable cast iron	
VDI 3323	1	2	3	4	5	6	7	8	9	10	11	12	13	14	15	16	17	18	19	20
HRc	13	25	28	32	32	10	29	32	38	15	35	15	23	10	10	26	3	25	21	23
HB	125	190	250	270	300	180	275	300	350	200	325	200	240	180	180	260	160	250	130	230
Recommend	○										○		○		○		○		○	

ISO Material Description	N										S						H				
	Aluminum-wrought alloy		Aluminum-cast, alloyed			Copper and Copper Alloys (Bronze / Brass)			Non Metallic Materials		Heat Resistant Super Alloys				Titanium Alloys		Hardened steel	Chilled Cast Iron	Hardened Cast Iron		
VDI 3323	21	22	23	24	25	26	27	28	29	30	31	32	33	34	35	36	37	38	39	40	41
HRc	15	30	25	38	34						15	30	25	38	34			55	60	42	55
HB	60	100	75	90	130	110	90	100			200	280	250	350	320	400 Rm	1050 Rm	550	630	400	550
Recommend	◎										◎						◎				



PLAIN SHANK **G8A50** SERIES

CARBIDE, 2 FLUTE MINIATURE CORNER RADIUS

- VOLLHARTMETALL, 2 SCHNEIDEN MINI ECKENRADIUS
- () Fraise carbure, 2 dents, torique, micro-fraise
- () 2 TAGLIENTI, TORICA MINI

- ▶ Designed to machine high hardened materials.
- ▶ Suitable for dry cutting, high speed cutting thanks to newly developed raw-material and new coating.
- ▶ Excellent workpiece finish.
- ▶ Deep slotting is possible by reduced neck.
- ▶ Corner radius for preventing the chipping in high speed machining.
- ▶ Higher wear-resistance.

- ▶ Geeignet zum Fräsen hochgehärteter Stähle.
- ▶ Geeignet zum Trockenfräsen und HSC-Fräsen dank neuentwickeltem Material und Beschichtung.
- ▶ Excellente Werkstückoberflächen.
- ▶ Abgesetzter Schaft für größere Reichweite.
- ▶ Schneidkantenschutz durch definierten Radius.
- ▶ Höhere Verschleißfestigkeit.

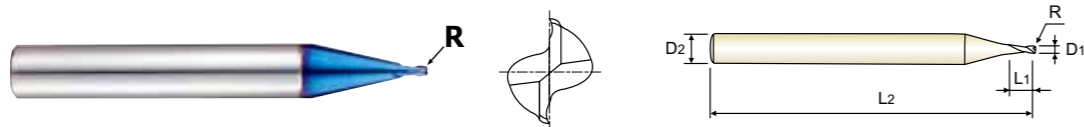

Icons: CARBIDE, 2, 30°, ±0.010, PLAIN, BLUE, p.C133

Recommended ToolHolder: HYDRAULIC CHUCK SHRINK FIT HOLDER (D15-46, D47-72), POWER MILLING CHUCK (D161-176), ER COLLET CHUCK (D73-116, D183-201), SK SLIM CHUCK

EDP No.	Corner Radius	Mill Diameter	Shank Diameter	Length of Cut	Overall Length
	R	D1	D2	L1	L2
G8A50003	-	0.3	6	0.45	50
G8A50004	-	0.4	6	0.6	50
G8A50005	R0.05	0.5	6	0.7	50
G8A50006	R0.05	0.6	6	0.9	50
G8A50008	R0.05	0.8	6	1.2	50
G8A50010	R0.10	1.0	6	1.5	50
G8A50012	R0.10	1.2	6	1.8	50
G8A50015	R0.15	1.5	6	2.2	50
G8A50020	R0.15	2.0	6	2.2	50

Due to the characteristics of the blue decoration layer, it might be erased during short term use and the color layer might not be uniformed. However, it doesn't affect the performance of the tool.

Mill Dia. Tolerance (mm)	Shank Dia. Tolerance
0 ~ - 0.012	h5

◎ : Excellent ○ : Good

ISO Material Description	P										M				K					
	Non-alloy steel					Low alloy steel					High alloyed steel, and tool steel		Stainless steel		Grey cast iron	Nodular cast iron		Malleable cast iron		
VDI 3323	1	2	3	4	5	6	7	8	9	10	11	12	13	14	15	16	17	18	19	20
HRc	13	25	28	32	35	10	29	32	38	15	35	15	23	10	10	26	3	25	21	21
HB	125	190	250	270	300	180	275	300	350	200	325	200	240	180	180	260	160	250	130	230
Recommend	○										○				○					

ISO Material Description	N					S					H										
	Aluminum-wrought alloy		Aluminum-cast, alloyed		Copper and Copper Alloys (Bronze / Brass)	Heat Resistant Super Alloys		Titanium Alloys		Hardened steel	Chilled Cast Iron	Hardened Cast Iron									
VDI 3323	21	22	23	24	25	26	27	28	29	30	31	32	33	34	35	36	37	38	39	40	41
HRc	15	30	25	38	34						15	30	25	38	34			55	60	42	55
HB	60	100	75	90	130	110	90	100			200	280	250	350	320	400 Rm	1050 Rm	550	630	400	550
Recommend	◎		◎		◎	◎					◎		◎								



PLAIN SHANK **G8A47** SERIES

CARBIDE, 4 FLUTE CORNER RADIUS with EXTENDED NECK

- VOLLHARTMETALL, 4 SCHNEIDEN ECKENRADIUS mit ABGESETZTEM SCHAFTTEIL
- () Fraise carbure, 2 dents, torique, micro-fraise
- () 4 TAGLIENTI, TORICA

- ▶ Designed to machine high hardened materials.
- ▶ Suitable for dry cutting, high speed cutting thanks to newly developed raw-material and new coating.
- ▶ Excellent workpiece finish.
- ▶ Deep slotting is possible by reduced neck.
- ▶ Corner radius for preventing the chipping in high speed machining.
- ▶ Higher wear-resistance.

- ▶ Geeignet zum Fräsen hochgehärteter Stähle.
- ▶ Geeignet zum Trockenfräsen und HSC-Fräsen dank neuentwickeltem Material und Beschichtung.
- ▶ Excellente Werkstückoberflächen.
- ▶ Abgesetzter Schaft für größere Reichweite.
- ▶ Schneidkantenschutz durch definierten Radius.
- ▶ Höhere Verschleißfestigkeit.

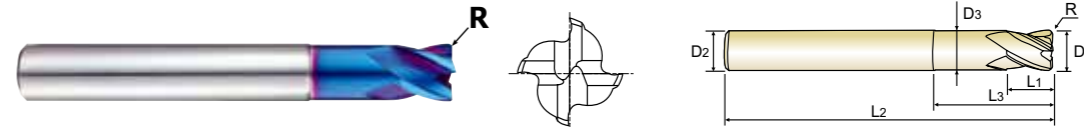

Icons: CARBIDE, 4, 30°, ±0.010, ±0.015, PLAIN, BLUE, p.C134

Recommended ToolHolder: HYDRAULIC CHUCK SHRINK FIT HOLDER (D15-46, D47-72), POWER MILLING CHUCK (D161-176), ER COLLET CHUCK (D73-116, D183-201), SK SLIM CHUCK

Unit : mm

EDP No.	Corner Radius	Mill Diameter	Shank Diameter	Length of Cut	Length Below Shank	Overall Length	Neck Diameter
	R (±0.010)	D1	D2	L1	L3	L2	D3
G8A47916	R0.3	3.0	6	4	12	55	2.85
G8A47917	R0.3	3.0	6	4	16	55	2.85
G8A47918	R0.3	3.0	6	4	20	55	2.85
G8A47030	R0.5	3.0	6	4	10	55	2.85
G8A47901	R0.5	3.0	6	4	16	55	2.85
G8A47902	R0.5	3.0	6	4	20	55	2.85
G8A47919	R0.3	4.0	6	5	12	55	3.85
G8A47920	R0.3	4.0	6	5	16	55	3.85
G8A47921	R0.3	4.0	6	5	20	55	3.85
G8A47040	R0.5	4.0	6	5	12	55	3.85
G8A47903	R0.5	4.0	6	5	16	55	3.85
G8A47904	R0.5	4.0	6	5	20	55	3.85
G8A47922	R1.0	4.0	6	5	12	55	3.85
G8A47060	R0.5	6.0	6	7	20	60	5.85
G8A47905	R1.0	6.0	6	7	20	60	5.85
G8A47906	R1.5	6.0	6	7	20	60	5.85
G8A47910	R0.5	8.0	8	9	25	60	7.7
G8A47080	R1.0	8.0	8	9	25	60	7.7
G8A47907	R1.5	8.0	8	9	25	60	7.7
G8A47913	R2.0	8.0	8	9	25	60	7.7
G8A47911	R0.5	10.0	10	11	32	70	9.7
G8A47100	R1.0	10.0	10	11	32	70	9.7
G8A47908	R1.5	10.0	10	11	32	70	9.7
G8A47914	R2.0	10.0	10	11	32	70	9.7
G8A47912	R0.5	12.0	12	12	38	80	11.7
G8A47120	R1.0	12.0	12	12	38	80	11.7
G8A47909	R1.5	12.0	12	12	38	80	11.7
G8A47915	R2.0	12.0	12	12	38	80	11.7

Due to the characteristics of the blue decoration layer, it might be erased during short term use and the color layer might not be uniformed. However, it doesn't affect the performance of the tool.

Size	Corner Radius Tolerance (mm)	Mill Dia. Tolerance (mm)	Shank Dia. Tolerance
up to Ø6	± 0.010	0 ~ - 0.012	h5
over Ø6	± 0.015	0 ~ - 0.015	

◎ : Excellent ○ : Good

ISO Material Description	P										M				K					
	Non-alloy steel					Low alloy steel					High alloyed steel, and tool steel		Stainless steel		Grey cast iron	Nodular cast iron		Malleable cast iron		
VDI 3323	1	2	3	4	5	6	7	8	9	10	11	12	13	14	15	16	17	18	19	20
HRc	13	25	28	32	35	10	29	32	38	15	35	15	23	10	10	26	3	25	21	21
HB	125	190	250	270	300	180	275	300	350	200	325	200	240	180	180	260	160	250	130	230
Recommend	○										○				○					

ISO Material Description	N					S					H										
	Aluminum-wrought alloy		Aluminum-cast, alloyed		Copper and Copper Alloys (Bronze / Brass)	Heat Resistant Super Alloys		Titanium Alloys		Hardened steel	Chilled Cast Iron	Hardened Cast Iron									
VDI 3323	21	22	23	24	25	26	27	28	29	30	31	32	33	34	35	36	37	38	39	40	41
HRc	15	30	25	38	34						15	30	25	38	34			55	60	42	55
HB	60	100	75	90	130	110	90	100			200	280	250	350	320	400 Rm	1050 Rm	550	630	400	550
Recommend	◎		◎		◎	◎					◎		◎								



PLAIN SHANK **G8A37** SERIES

CARBIDE, 4 FLUTE STUB LENGTH CORNER RADIUS with EXTENDED NECK

● **VOLLHARTMETALL, 4 SCHNEIDEN EXTRA KURZ ECKENRADIUS mit ABGESETZTEM SCHAFTTEIL**
 () **Fraise carbure, 4 dents, torique, détalonnée, extra-courte**
 () **4 TAGLIENTI, TORICA, TAGLIENTE CORTO CON SCARICO ESTESO**

- ▶ Designed to machine high hardened materials.
- ▶ Suitable for dry cutting, high speed cutting thanks to newly developed raw-material and new coating.
- ▶ Excellent workpiece finish.
- ▶ Deep slotting is possible by reduced neck.
- ▶ Corner radius for preventing the chipping in high speed machining.
- ▶ Higher wear-resistance.

- ▶ Geeignet zum Fräsen hochgehärteter Stähle.
- ▶ Geeignet zum Trockenfräsen und HSC-Fräsen dank neuentwickeltem Material und Beschichtung.
- ▶ Excellente Werkstückoberflächen.
- ▶ Abgesetzter Schaft für größere Reichweite.
- ▶ Schneidkantenschutz durch definierten Radius.
- ▶ Höhere Verschleißfestigkeit.

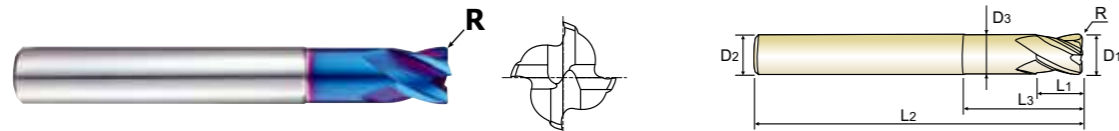

CARBIDE 4 30° ±0.010 ±0.015 PLAIN BLUE p.C140

Recommended ToolHolder: HYDRAULIC CHUCK SHRINK FIT HOLDER (D15-46, D47-72), POWER MILLING CHUCK (D161-176), ER COLLET CHUCK SK SLIM CHUCK (D73-116, D183-201)

EDP No.	Corner Radius	Mill Diameter	Shank Diameter	Length of Cut	Length Below Shank	Overall Length	Neck Diameter
	R (±0.010)	D1	D2	L1	L3	L2	D3
G8A37010	R0.1	1.0	3	1.5	-	40	-
G8A37901	R0.1	1.0	6	1.5	-	40	-
G8A37015	R0.1	1.5	3	2.2	-	40	-
G8A37902	R0.1	1.5	6	2.2	-	40	-
G8A37020	R0.1	2.0	3	3	6	40	1.95
G8A37903	R0.1	2.0	6	3	6	40	1.95
G8A37025	R0.1	2.5	3	4	6	40	2.4
G8A37904	R0.1	2.5	6	4	6	40	2.4
G8A37030	R0.1	3.0	6	4	7	45	2.85
G8A37035	R0.1	3.5	6	5	9	45	3.35
G8A37040	R0.1	4.0	6	5	9	45	3.85
G8A37045	R0.1	4.5	6	6	10	45	4.35
G8A37050	R0.2	5.0	6	6	11	50	4.85
G8A37060	R0.2	6.0	6	7	14	50	5.85
G8A37080	R0.2	8.0	8	9	18	60	7.7
G8A37100	R0.2	10.0	10	12	25	75	9.7
G8A37120	R0.3	12.0	12	15	30	75	11.7
G8A37160	R0.3	16.0	16	18	38	90	15.7
G8A37200	R0.3	20.0	20	24	45	100	19.7

Due to the characteristics of the blue decoration layer, it might be erased during short term use and the color layer might not be uniformed. However, it doesn't affect the performance of the tool.

Size	Corner Radius Tolerance (mm)	Mill Dia. Tolerance (mm)	Shank Dia. Tolerance
up to Ø6	± 0.010	0 ~ - 0.012	h5
over Ø6	± 0.015	0 ~ - 0.015	

◎ : Excellent ○ : Good

ISO	P										M				K					
	Non-alloy steel					Low alloy steel					High alloyed steel, and tool steel		Stainless steel		Grey cast iron	Nodular cast iron		Malleable cast iron		
Material Description	1	2	3	4	5	6	7	8	9	10	11	12	13	14	15	16	17	18	19	20
VDI 3323	1	2	3	4	5	6	7	8	9	10	11	12	13	14	15	16	17	18	19	20
HRc	13	25	28	32	32	10	29	32	38	15	35	15	23	10	10	26	3	25	21	21
HB	125	190	250	270	300	180	275	300	350	200	325	200	240	180	180	260	160	250	130	230
Recommend	○										○		○		○					

ISO	N					S					H										
	Aluminum-wrought alloy		Aluminum-cast, alloyed			Copper and Copper Alloys (Bronze / Brass)			Non Metallic Materials		Heat Resistant Super Alloys			Titanium Alloys	Hardened steel	Chilled Cast Iron	Hardened Cast Iron				
Material Description	21	22	23	24	25	26	27	28	29	30	31	32	33	34	35	36	37	38	39	40	41
VDI 3323	21	22	23	24	25	26	27	28	29	30	31	32	33	34	35	36	37	38	39	40	41
HRc	21	22	23	24	25	26	27	28	29	30	31	32	33	34	35	36	37	38	39	40	41
HB	60	100	75	90	130	110	90	100			200	280	250	350	320	400 Rm	1050 Rm	550	630	400	550
Recommend	◎		◎			◎			◎		◎			◎			◎				



PLAIN SHANK **G8B08** SERIES

CARBIDE, 4 FLUTE CORNER RADIUS with EXTENDED NECK

● **VOLLHARTMETALL, 4 SCHNEIDEN ECKENRADIUS mit ABGESETZTEM SCHAFTTEIL**
 () **Fraise carbure, 4 dents, torique, détalonnée**
 () **4 TAGLIENTI, TORICA, TAGLIENTE CORTO CON SCARICO ESTESO**

- ▶ Designed to machine high hardened materials.
- ▶ Suitable for dry cutting, high speed cutting thanks to newly developed raw-material and new coating.
- ▶ Excellent workpiece finish.
- ▶ Deep slotting is possible by reduced neck.
- ▶ Corner radius for preventing the chipping in high speed machining.
- ▶ Higher wear-resistance.

- ▶ Geeignet zum Fräsen hochgehärteter Stähle.
- ▶ Geeignet zum Trockenfräsen und HSC-Fräsen dank neuentwickeltem Material und Beschichtung.
- ▶ Excellente Werkstückoberflächen.
- ▶ Abgesetzter Schaft für größere Reichweite.
- ▶ Schneidkantenschutz durch definierten Radius.
- ▶ Höhere Verschleißfestigkeit.

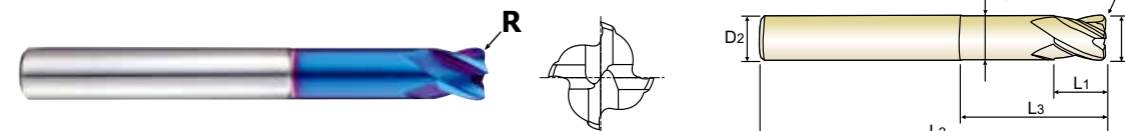

CARBIDE 4 30° ±0.010 ±0.015 PLAIN BLUE p.C134

Recommended ToolHolder: HYDRAULIC CHUCK SHRINK FIT HOLDER (D15-46, D47-72), POWER MILLING CHUCK (D161-176), ER COLLET CHUCK SK SLIM CHUCK (D73-116, D183-201)

EDP No.	Corner Radius	Mill Diameter	Shank Diameter	Length of Cut	Length Below Shank	Overall Length	Neck Diameter
	R (±0.010)	D1	D2	L1	L3	L2	D3
G8B0806005090	R0.5	6.0	6	9	20	90	5.85
G8B0806010090	R1.0	6.0	6	9	20	90	5.85
G8B0808005100	R0.5	8.0	8	12	25	100	7.7
G8B0808010100	R1.0	8.0	8	12	25	100	7.7
G8B0810005100	R0.5	10.0	10	15	32	100	9.7
G8B0810010100	R1.0	10.0	10	15	32	100	9.7
G8B0810020100	R2.0	10.0	10	15	32	100	9.7
G8B0812005110	R0.5	12.0	12	18	38	110	11.7
G8B0812010110	R1.0	12.0	12	18	38	110	11.7
G8B0812020110	R2.0	12.0	12	18	38	110	11.7

Due to the characteristics of the blue decoration layer, it might be erased during short term use and the color layer might not be uniformed. However, it doesn't affect the performance of the tool.

Size	Corner Radius Tolerance (mm)	Mill Dia. Tolerance (mm)	Shank Dia. Tolerance
up to Ø6	± 0.010	0 ~ - 0.012	h5
over Ø6	± 0.015	0 ~ - 0.015	

◎ : Excellent ○ : Good

ISO	P										M				K					
	Non-alloy steel					Low alloy steel					High alloyed steel, and tool steel		Stainless steel		Grey cast iron	Nodular cast iron		Malleable cast iron		
Material Description	1	2	3	4	5	6	7	8	9	10	11	12	13	14	15	16	17	18	19	20
VDI 3323	1	2	3	4	5	6	7	8	9	10	11	12	13	14	15	16	17	18	19	20
HRc	13	25	28	32	32	10	29	32	38	15	35	15	23	10	10	26	3	25	21	21
HB	125	190	250	270	300	180	275	300	350	200	325	200	240	180	180	260	160	250	130	230
Recommend	○										○		○		○					

ISO	N					S					H										
	Aluminum-wrought alloy		Aluminum-cast, alloyed			Copper and Copper Alloys (Bronze / Brass)			Non Metallic Materials		Heat Resistant Super Alloys			Titanium Alloys	Hardened steel	Chilled Cast Iron	Hardened Cast Iron				
Material Description	21	22	23	24	25	26	27	28	29	30	31	32	33	34	35	36	37	38	39	40	41
VDI 3323	21	22	23	24	25	26	27	28	29	30	31	32	33	34	35	36	37	38	39	40	41
HRc	21	22	23	24	25	26	27	28	29	30	31	32	33	34	35	36	37	38	39	40	41
HB	60	100	75	90	130	110	90	100			200	280	250	350	320	400 Rm	1050 Rm	550	630	400	550
Recommend	◎		◎			◎			◎		◎			◎			◎				

CARBIDE, 6 FLUTE 45° HELIX CORNER RADIUS with EXTENDED NECK

● **VOLLHARTMETALL, 6 SCHNEIDEN 45° RECHTSSPIRALE ECKENRADIUS mit ABGESETZTEM SCHAFTTEIL**
 (●) **Fraise carbure, 6 dents, torique, hélice 45°, détalonnée**
 (●) **6 TAGLIENTI, TORICA, ELICA 45°, SCARICATA**

- ▶ Designed to machine high hardened materials.
- ▶ Suitable for dry cutting, high speed cutting thanks to newly developed raw-material and new coating.
- ▶ Excellent workpiece finish.
- ▶ Deep slotting is possible by reduced neck.
- ▶ Corner radius for preventing the chipping in high speed machining.
- ▶ Higher wear-resistance.

- ▶ Geeignet zum Fräsen hochgehärteter Stähle.
- ▶ Geeignet zum Trockenfräsen und HSC-Fräsen dank neuentwickeltem Material und Beschichtung.
- ▶ Excellente Werkstückoberflächen.
- ▶ Abgesetzter Schaft für größere Reichweite.
- ▶ Schneidkantenschutz durch definierten Radius.
- ▶ Höhere Verschleißfestigkeit.

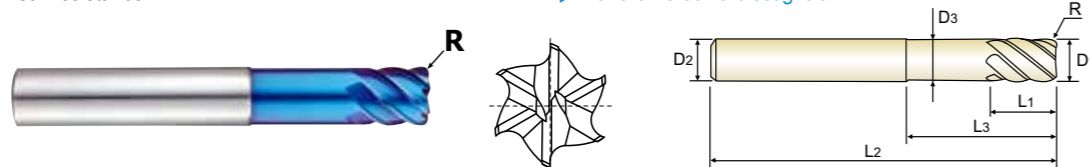

Plain Shank	Page
HYDRAULIC CHUCK SHRINK FIT HOLDER	D15-46 D47-72
POWER MILLING CHUCK	D161-176
ER COLLET CHUCK SK SLIM CHUCK	D73-116 D183-201

Unit : mm

EDP No.	Corner Radius	Mill Diameter	Shank Diameter	Length of Cut	Length Below Shank	Overall Length	Neck Diameter
	R (±0.010)	D1	D2	L1	L3	L2	D3
G8A39916	R0.25	6.0	6	6	14	50	5.85
G8A39060	R0.5	6.0	6	6	14	50	5.85
G8A39901	R0.5	6.0	6	13	-	70	-
* G8A39910	R0.5	6.0	6	26	-	70	-
G8A39080	R0.5	8.0	8	8	24	60	7.7
G8A39902	R0.5	8.0	8	19	-	90	-
* G8A39911	R0.5	8.0	8	36	-	90	-
G8A39903	R0.5	10.0	10	22	-	100	-
G8A39100	R1.0	10.0	10	10	30	70	9.7
G8A39904	R1.0	10.0	10	22	-	100	-
* G8A39912	R1.0	10.0	10	46	-	100	-
G8A39905	R0.5	12.0	12	26	-	110	-
G8A39120	R1.0	12.0	12	12	30	75	11.7
G8A39906	R1.0	12.0	12	26	-	110	-
* G8A39913	R1.0	12.0	12	56	-	110	-
G8A39160	R1.0	16.0	16	32	-	130	-
G8A39907	R1.5	16.0	16	32	-	130	-
* G8A39914	R1.5	16.0	16	66	-	130	-
G8A39200	R1.0	20.0	20	38	-	140	-
G8A39908	R1.5	20.0	20	38	-	140	-
G8A39909	R2.0	20.0	20	38	-	140	-
* G8A39915	R2.0	20.0	20	76	-	140	-

Due to the characteristics of the blue decoration layer, it might be erased during short term use and the color layer might not be uniformed. However, it doesn't affect the performance of the tool.

Size	Corner Radius Tolerance (mm)	Mill Dia. Tolerance (mm)	Shank Dia. Tolerance
up to Ø6	± 0.010	0 ~ - 0.012	h5
over Ø6	± 0.015	0 ~ - 0.015	

* Mill Dia. Tolerance(mm) for Extra Long Type : 0~-0.03

◎ : Excellent ○ : Good

ISO	P										M				K					
	Non-alloy steel					Low alloy steel					High alloyed steel, and tool steel		Stainless steel		Grey cast iron	Nodular cast iron		Malleable cast iron		
Material Description	1	2	3	4	5	6	7	8	9	10	11	12	13	14	15	16	17	18	19	20
VDI 3323	1	2	3	4	5	6	7	8	9	10	11	12	13	14	15	16	17	18	19	20
HRc	13	25	28	32	38	10	29	32	38	15	35	15	23	10	10	26	3	25	21	21
HB	125	190	250	270	300	180	275	300	350	200	325	200	240	180	180	260	160	250	130	230
Recommend	○										○				○					

ISO	N										S				H							
	Aluminum-wrought alloy		Aluminum-cast, alloyed			Copper and Copper Alloys (Bronze / Brass)					Non Metallic Materials		Heat Resistant Super Alloys				Titanium Alloys		Hardened steel	Chilled Cast Iron	Hardened Cast Iron	
Material Description	21	22	23	24	25	26	27	28	29	30	31	32	33	34	35	36	37	38	39	40	41	
VDI 3323	21	22	23	24	25	26	27	28	29	30	31	32	33	34	35	36	37	38	39	40	41	
HRc	21	22	23	24	25	26	27	28	29	30	15	30	25	38	34	55	60	42	42	55	55	
HB	60	100	75	90	130	110	90	100			200	280	250	350	320	400 Rm	1050 Rm	550	630	400	550	
Recommend	◎										◎				◎		◎	◎	◎	◎	◎	◎

CARBIDE, 2 FLUTE for RIB PROCESSING

● **VOLLHARTMETALL, 2 SCHNEIDEN für SCHMALE RIPPEN**
 (●) **Fraise carbure, 2 dents pour usinage de rainure**
 (●) **2 TAGLIENTI PER NERVATURE**

- ▶ Designed to machine high hardened materials.
- ▶ Suitable for dry cutting, high speed cutting thanks to newly developed raw-material and new coating.
- ▶ Excellent workpiece finish.
- ▶ Designed for high precision milling operation.
- ▶ Higher wear-resistance.

- ▶ Geeignet zum Fräsen hochgehärteter Stähle.
- ▶ Geeignet zum Trockenfräsen und HSC-Fräsen dank neuentwickeltem Material und Beschichtung.
- ▶ Excellente Werkstückoberflächen.
- ▶ Geeignet für hochpräzises Fräsen.
- ▶ Höhere Verschleißfestigkeit.

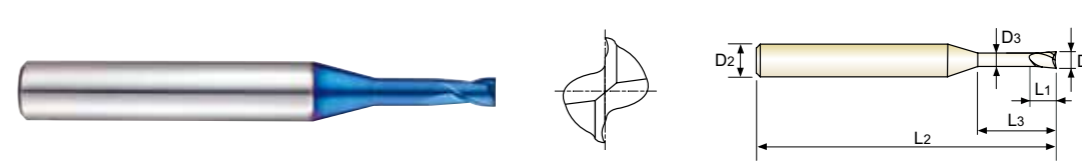

Plain Shank	Page
HYDRAULIC CHUCK SHRINK FIT HOLDER	D15-46 D47-72
POWER MILLING CHUCK	D161-176
ER COLLET CHUCK SK SLIM CHUCK	D73-116 D183-201

Unit : mm

EDP No.	Mill Diameter	Shank Diameter	Length of Cut	Length Below Shank	Overall Length	Neck Diameter
	D1	D2	L1	L3	L2	D3
G8A45863	0.1	4	0.15	0.3	45	0.085
G8A45864	0.1	4	0.15	0.5	45	0.085
G8A45002	0.2	4	0.3	0.5	45	0.17
G8A45815	0.2	4	0.3	1	45	0.17
G8A45816	0.2	4	0.3	1.5	45	0.17
G8A45003	0.3	4	0.45	1	45	0.27
G8A45844	0.3	4	0.45	1.5	45	0.27
G8A45817	0.3	4	0.45	2	45	0.27
G8A45818	0.3	4	0.45	3	45	0.27
G8A45842	0.3	4	0.45	4	45	0.27
G8A45843	0.4	4	0.6	1	45	0.37
G8A45004	0.4	4	0.6	2	45	0.37
G8A45984	0.4	4	0.6	3	45	0.37
G8A45985	0.4	4	0.6	4	45	0.37
G8A45986	0.4	4	0.6	5	45	0.37
G8A45005	0.5	4	0.7	2	45	0.45
G8A45861	0.5	4	0.7	2.5	45	0.45
G8A45988	0.5	4	0.7	4	45	0.45
G8A45989	0.5	4	0.7	6	45	0.45
G8A45990	0.5	4	0.7	8	45	0.45
G8A45006	0.6	4	0.9	2	45	0.55
G8A45860	0.6	4	0.9	3	45	0.55

Due to the characteristics of the blue decoration layer, it might be erased during short term use and the color layer might not be uniformed. However, it doesn't affect the performance of the tool. ▶ NEXT PAGE

Mill Dia. Tolerance (mm)	Shank Dia. Tolerance
0 ~ - 0.012	h5

◎ : Excellent ○ : Good

ISO	P										M				K					
	Non-alloy steel					Low alloy steel					High alloyed steel, and tool steel		Stainless steel		Grey cast iron	Nodular cast iron		Malleable cast iron		
Material Description	1	2	3	4	5	6	7	8	9	10	11	12	13	14	15	16	17	18	19	20
VDI 3323	1	2	3	4	5	6	7	8	9	10	11	12	13	14	15	16	17	18	19	20
HRc	13	25	28	32	38	10	29	32	38	15	35	15	23	10	10	26	3	25	21	21
HB	125	190	250	270	300	180	275	300	350	200	325	200	240	180	180	260	160	250	130	230
Recommend	○										○				○					

ISO	N										S				H							
	Aluminum-wrought alloy		Aluminum-cast, alloyed			Copper and Copper Alloys (Bronze / Brass)					Non Metallic Materials		Heat Resistant Super Alloys				Titanium Alloys		Hardened steel	Chilled Cast Iron	Hardened Cast Iron	
Material Description	21	22	23	24	25	26	27	28	29	30	31	32	33	34	35	36	37	38	39	40	41	
VDI 3323	21	22	23	24	25	26	27	28	29	30	31	32	33	34	35	36	37	38	39	40	41	
HRc	21	22	23	24	25	26	27	28	29	30	15	30	25	38	34	55	60	42	42	55	55	
HB	60	100	75	90	130	110	90	100			200	280	250	350	320	400 Rm	1050 Rm	550	630	400	550	
Recommend	◎										◎				◎		◎	◎	◎	◎	◎	◎

CARBIDE, 2 FLUTE for RIB PROCESSING

● **VOLLHARTMETALL, 2 SCHNEIDEN für SCHMALE RIPPEN**
 (●) **Fraise carbure, 2 dents pour usinage de rainure**
 (●) **2 TAGLIANTI PER NERVATURE**

- ▶ Designed to machine high hardened materials.
- ▶ Suitable for dry cutting, high speed cutting thanks to newly developed raw-material and new coating.
- ▶ Excellent workpiece finish.
- ▶ Designed for high precision milling operation.
- ▶ Higher wear-resistance.

- ▶ Geeignet zum Fräsen hochgehärteter Stähle.
- ▶ Geeignet zum Trockenfräsen und HSC-Fräsen dank neuentwickeltem Material und Beschichtung.
- ▶ Excellente Werkstückoberflächen.
- ▶ Geeignet für hochpräzises Fräsen.
- ▶ Höhere Verschleißfestigkeit.

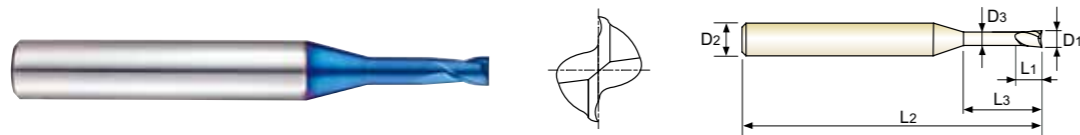

p.C135-136

Recommended ToolHolder	Plain Shank	Page
HYDRAULIC CHUCK	D15-46	D15-46
SHRINK FIT HOLDER	D47-72	D47-72
POWER MILLING CHUCK	D161-176	D161-176
ER COLLET CHUCK	D73-116	D73-116
SK SLIM CHUCK	D183-201	D183-201

Unit : mm

EDP No.	Mill Diameter	Shank Diameter	Length of Cut	Length Below Shank	Overall Length	Neck Diameter
	D1	D2	L1	L3	L2	D3
G8A45991	0.6	4	0.9	4	45	0.55
G8A45992	0.6	4	0.9	6	45	0.55
G8A45993	0.6	4	0.9	8	45	0.55
G8A45819	0.6	4	0.9	10	45	0.55
G8A45862	0.8	4	1.2	2	45	0.75
G8A45008	0.8	4	1.2	4	45	0.75
G8A45908	0.8	4	1.2	6	45	0.75
G8A45909	0.8	4	1.2	8	45	0.75
G8A45994	0.8	4	1.2	10	45	0.75
G8A45995	0.8	4	1.2	12	45	0.75
G8A45996	1.0	4	1.5	4	45	0.95
G8A45010	1.0	4	1.5	6	45	0.95
G8A45912	1.0	4	1.5	8	45	0.95
G8A45913	1.0	4	1.5	10	45	0.95
G8A45914	1.0	4	1.5	12	45	0.95
G8A45997	1.0	4	1.5	16	50	0.95
G8A45998	1.0	4	1.5	20	55	0.95
G8A45012	1.2	4	1.8	6	45	1.15
G8A45915	1.2	4	1.8	8	45	1.15
G8A45916	1.2	4	1.8	10	45	1.15
G8A45917	1.2	4	1.8	12	45	1.15
G8A45999	1.2	4	1.8	16	50	1.15

Due to the characteristics of the blue decoration layer, it might be erased during short term use and the color layer might not be uniformed. However, it doesn't affect the performance of the tool. ▶ NEXT PAGE

Mill Dia. Tolerance (mm)	Shank Dia. Tolerance
0 ~ - 0.012	h5

◎ : Excellent ○ : Good

ISO	P										M				K					
	Non-alloy steel					Low alloy steel					High alloyed steel, and tool steel		Stainless steel		Grey cast iron	Nodular cast iron		Malleable cast iron		
Material Description	1	2	3	4	5	6	7	8	9	10	11	12	13	14	15	16	17	18	19	20
VDI 3323	1	2	3	4	5	6	7	8	9	10	11	12	13	14	15	16	17	18	19	20
HRc	13	25	28	32	30	10	29	32	38	15	35	15	23	10	10	26	3	25	21	21
HB	125	190	250	270	300	180	275	300	350	200	325	200	240	180	180	260	160	250	130	230
Recommend					○				○	○										

ISO	N					S					H										
	Aluminum-wrought alloy		Aluminum-cast, alloyed		Copper and Copper Alloys (Bronze / Brass)	Non Metallic Materials		Heat Resistant Super Alloys			Titanium Alloys		Hardened steel	Chilled Cast Iron	Hardened Cast Iron						
Material Description	21	22	23	24	25	26	27	28	29	30	31	32	33	34	35	36	37	38	39	40	41
VDI 3323	21	22	23	24	25	26	27	28	29	30	31	32	33	34	35	36	37	38	39	40	41
HRc											15	30	25	38	34			55	60	42	55
HB	60	100	75	90	130	110	90	100			200	280	250	350	320	400 Rm	1050 Rm	550	630	400	550
Recommend																		◎	◎	○	◎

CARBIDE, 2 FLUTE for RIB PROCESSING

● **VOLLHARTMETALL, 2 SCHNEIDEN für SCHMALE RIPPEN**
 (●) **Fraise carbure, 2 dents pour usinage de rainure**
 (●) **2 TAGLIANTI PER NERVATURE**

- ▶ Designed to machine high hardened materials.
- ▶ Suitable for dry cutting, high speed cutting thanks to newly developed raw-material and new coating.
- ▶ Excellent workpiece finish.
- ▶ Designed for high precision milling operation.
- ▶ Higher wear-resistance.

- ▶ Geeignet zum Fräsen hochgehärteter Stähle.
- ▶ Geeignet zum Trockenfräsen und HSC-Fräsen dank neuentwickeltem Material und Beschichtung.
- ▶ Excellente Werkstückoberflächen.
- ▶ Geeignet für hochpräzises Fräsen.
- ▶ Höhere Verschleißfestigkeit.

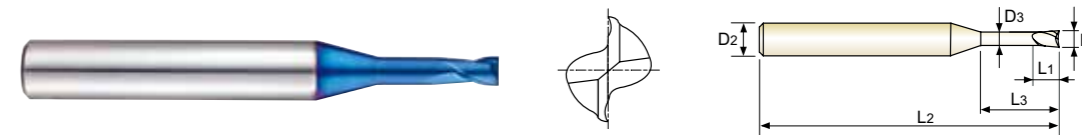

p.C135-136

Recommended ToolHolder	Plain Shank	Page
HYDRAULIC CHUCK	D15-46	D15-46
SHRINK FIT HOLDER	D47-72	D47-72
POWER MILLING CHUCK	D161-176	D161-176
ER COLLET CHUCK	D73-116	D73-116
SK SLIM CHUCK	D183-201	D183-201

Unit : mm

EDP No.	Mill Diameter	Shank Diameter	Length of Cut	Length Below Shank	Overall Length	Neck Diameter
	D1	D2	L1	L3	L2	D3
G8A45015	1.5	4	2.3	6	45	1.45
G8A45923	1.5	4	2.3	8	45	1.45
G8A45924	1.5	4	2.3	10	45	1.45
G8A45925	1.5	4	2.3	12	45	1.45
G8A45926	1.5	4	2.3	14	50	1.45
G8A45927	1.5	4	2.3	16	50	1.45
G8A45928	1.5	4	2.3	18	55	1.45
G8A45810	1.5	4	2.3	20	55	1.45
G8A45958	2.0	4	3.0	6	45	1.95
G8A45020	2.0	4	3.0	8	45	1.95
G8A45959	2.0	4	3.0	10	45	1.95
G8A45960	2.0	4	3.0	12	45	1.95
G8A45961	2.0	4	3.0	14	50	1.95
G8A45962	2.0	4	3.0	16	50	1.95
G8A45963	2.0	4	3.0	18	55	1.95
G8A45964	2.0	4	3.0	20	55	1.95
G8A45966	2.0	4	3.0	25	60	1.95
G8A45814	2.0	4	3.0	30	70	1.95
G8A45975	3.0	6	4.5	10	45	2.85
G8A45976	3.0	6	4.5	12	45	2.85
G8A45977	3.0	6	4.5	14	50	2.85
G8A45978	3.0	6	4.5	16	55	2.85

Due to the characteristics of the blue decoration layer, it might be erased during short term use and the color layer might not be uniformed. However, it doesn't affect the performance of the tool. ▶ NEXT PAGE

Mill Dia. Tolerance (mm)	Shank Dia. Tolerance
0 ~ - 0.012	h5

◎ : Excellent ○ : Good

ISO	P										M				K					
	Non-alloy steel					Low alloy steel					High alloyed steel, and tool steel		Stainless steel		Grey cast iron	Nodular cast iron		Malleable cast iron		
Material Description	1	2	3	4	5	6	7	8	9	10	11	12	13	14	15	16	17	18	19	20
VDI 3323	1	2	3	4	5	6	7	8	9	10	11	12	13	14	15	16	17	18	19	20
HRc	13	25	28	32	30	10	29	32	38	15	35	15	23	10	10	26	3	25	21	21
HB	125	190	250	270	300	180	275	300	350	200	325	200	240	180	180	260	160	250	130	230
Recommend					○				○	○										

ISO	N					S					H										
	Aluminum-wrought alloy		Aluminum-cast, alloyed		Copper and Copper Alloys (Bronze / Brass)	Non Metallic Materials		Heat Resistant Super Alloys			Titanium Alloys		Hardened steel	Chilled Cast Iron	Hardened Cast Iron						
Material Description	21	22	23	24	25	26	27	28	29	30	31	32	33	34	35	36	37	38	39	40	41
VDI 3323	21	22	23	24	25	26	27	28	29	30	31	32	33	34	35	36	37	38	39	40	41
HRc											15	30	25	38	34			55	60	42	55
HB	60	100	75	90	130	110	90	100			200	280	250	350	320	400 Rm	1050 Rm	550	630	400	550
Recommend																		◎	◎	○	◎



PLAIN SHANK **G8A45** SERIES

CARBIDE, 2 FLUTE for RIB PROCESSING

- VOLLHARTMETALL, 2 SCHNEIDEN für SCHMALE RIPPEN
- ① Fraise carbure, 2 dents pour usinage de rainure
- ② 2 TAGLIENTI PER NERVATURE

- ▶ Designed to machine high hardened materials.
- ▶ Suitable for dry cutting, high speed cutting thanks to newly developed raw-material and new coating.
- ▶ Excellent workpiece finish.
- ▶ Designed for high precision milling operation.
- ▶ Higher wear-resistance.

- ▶ Geeignet zum Fräsen hochgehärteter Stähle.
- ▶ Geeignet zum Trockenfräsen und HSC-Fräsen dank neuentwickeltem Material und Beschichtung.
- ▶ Excellente Werkstückoberflächen.
- ▶ Geeignet für hochpräzises Fräsen.
- ▶ Höhere Verschleißfestigkeit.

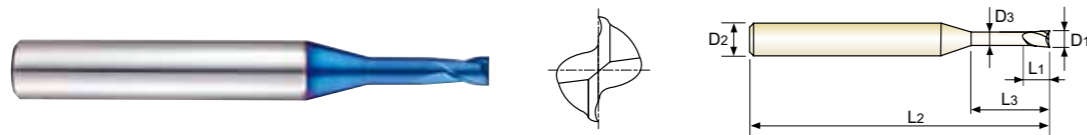

Recommended ToolHolder	Plain Shank	Page
①	HYDRAULIC CHUCK SHRINK FIT HOLDER	D15-46 D47-72
②	POWER MILLING CHUCK	D161-176
③	ER COLLET CHUCK SK SLIM CHUCK	D73-116 D183-201

Unit : mm

EDP No.	Mill Diameter	Shank Diameter	Length of Cut	Length Below Shank	Overall Length	Neck Diameter
	D1	D2	L1	L3	L2	D3
G8A45979	3.0	6	4.5	18	55	2.85
G8A45980	3.0	6	4.5	20	60	2.85
G8A45981	3.0	6	4.5	25	65	2.85
G8A45832	3.0	6	4.5	30	70	2.85
G8A45833	3.0	6	4.5	35	80	2.85
G8A45983	3.0	6	4.5	40	90	2.85
G8A45040	4.0	6	6	12	50	3.85
G8A45801	4.0	6	6	16	60	3.85
G8A45802	4.0	6	6	20	60	3.85
G8A45803	4.0	6	6	25	70	3.85
G8A45834	4.0	6	6	30	70	3.85
G8A45835	4.0	6	6	35	80	3.85
G8A45836	4.0	6	6	40	90	3.85
G8A45837	4.0	6	6	45	90	3.85
G8A45838	4.0	6	6	50	100	3.85

Due to the characteristics of the blue decoration layer, it might be erased during short term use and the color layer might not be uniformed. However, it doesn't affect the performance of the tool.

Mill Dia. Tolerance (mm)	Shank Dia. Tolerance
0 ~ - 0.012	h5

◎ : Excellent ○ : Good

ISO Material Description	P										M				K					
	Non-alloy steel					Low alloy steel					High alloyed steel, and tool steel		Stainless steel		Grey cast iron		Nodular cast iron		Malleable cast iron	
VDI 3323	1	2	3	4	5	6	7	8	9	10	11	12	13	14	15	16	17	18	19	20
HRc	13	25	28	32	38	10	29	32	38	15	35	15	23	10	10	26	3	25	21	21
HB	125	190	250	270	300	180	275	300	350	200	325	200	240	180	180	260	160	250	130	230
Recommend	○										○		○		○		○		○	

ISO Material Description	N					S					H										
	Aluminum-wrought alloy		Aluminum-cast, alloyed			Copper and Copper Alloys (Bronze / Brass)			Non Metallic Materials		Heat Resistant Super Alloys			Titanium Alloys	Hardened steel	Chilled Cast Iron	Hardened Cast Iron				
VDI 3323	21	22	23	24	25	26	27	28	29	30	31	32	33	34	35	36	37	38	39	40	41
HRc	21	22	23	24	25	26	27	28	29	30	15	30	25	38	34	34	34	55	60	42	55
HB	60	100	75	90	130	110	90	100			200	280	250	350	320	400 Rm	1050 Rm	550	630	400	550
Recommend	◎					◎					◎			◎	◎	◎	◎	◎	◎	◎	◎



PLAIN SHANK **G8A01** SERIES

CARBIDE, 2 FLUTE with EXTENDED NECK

- VOLLHARTMETALL, 2 SCHNEIDEN mit ABGESETZTEM SCHAFTTEIL
- ① Fraise carbure, 2 dents, détalonnée
- ② 2 TAGLIENTI CON SCARICO ESTESO

- ▶ Designed to machine high hardened materials.
- ▶ Suitable for dry cutting, high speed cutting thanks to newly developed raw-material and new coating.
- ▶ Excellent workpiece finish.
- ▶ Designed for high precision milling operation.
- ▶ Higher wear-resistance.

- ▶ Geeignet zum Fräsen hochgehärteter Stähle.
- ▶ Geeignet zum Trockenfräsen und HSC-Fräsen dank neuentwickeltem Material und Beschichtung.
- ▶ Excellente Werkstückoberflächen.
- ▶ Geeignet für hochpräzises Fräsen.
- ▶ Höhere Verschleißfestigkeit.

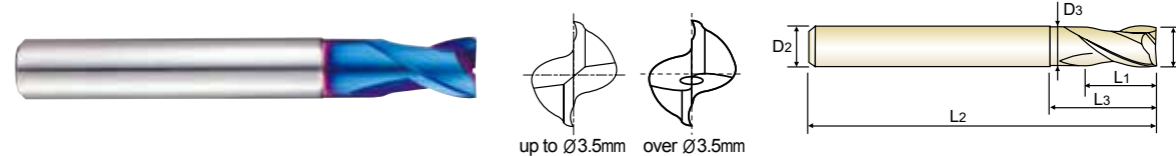

Recommended ToolHolder	Plain Shank	Page
①	HYDRAULIC CHUCK SHRINK FIT HOLDER	D15-46 D47-72
②	POWER MILLING CHUCK	D161-176
③	ER COLLET CHUCK SK SLIM CHUCK	D73-116 D183-201

Unit : mm

EDP No.	Mill Diameter	Shank Diameter	Length of Cut	Length Below Shank	Overall Length	Neck Diameter
	D1	D2	L1	L3	L2	D3
G8A01001	0.1	4	0.2	-	40	-
G8A01002	0.2	4	0.4	-	40	-
G8A01003	0.3	4	0.6	-	40	-
G8A01004	0.4	4	0.8	-	40	-
G8A01005	0.5	4	1	-	40	-
G8A01006	0.6	4	1.2	-	40	-
G8A01007	0.7	4	1.4	-	40	-
G8A01008	0.8	4	1.6	-	40	-
G8A01009	0.9	4	2	-	40	-
G8A010104S	1.0	4	1.5	3	50	0.95
G8A01010	1.0	6	1.5	3	50	0.95
G8A010154S	1.5	4	1.7	4	50	1.45
G8A01015	1.5	6	1.7	4	50	1.45
G8A010204S	2.0	4	2	5	50	1.95
G8A01020	2.0	6	2	5	50	1.95
G8A010254S	2.5	4	2.5	6	55	2.4
G8A01025	2.5	6	2.5	6	55	2.4
G8A01030	3.0	6	3	8	55	2.85
G8A01035	3.5	6	3.5	9	55	3.35
G8A01040	4.0	6	4	10	55	3.85
G8A01050	5.0	6	5	13	55	4.85
G8A01060	6.0	6	6	15	55	5.85
G8A01080	8.0	8	8	20	65	7.7
G8A01100	10.0	10	10	25	75	9.7
G8A01120	12.0	12	12	28	85	11.7
G8A01160	16.0	16	16	32	90	15.7
G8A01200	20.0	20	20	40	105	19.7

Due to the characteristics of the blue decoration layer, it might be erased during short term use and the color layer might not be uniformed. However, it doesn't affect the performance of the tool.

Size	Mill Dia. Tolerance (mm)	Shank Dia. Tolerance
up to Ø6	0 ~ - 0.012	h5
over Ø6	0 ~ - 0.015	

◎ : Excellent ○ : Good

ISO Material Description	P										M				K					
	Non-alloy steel					Low alloy steel					High alloyed steel, and tool steel		Stainless steel		Grey cast iron		Nodular cast iron		Malleable cast iron	
VDI 3323	1	2	3	4	5	6	7	8	9	10	11	12	13	14	15	16	17	18	19	20
HRc	13	25	28	32	38	10	29	32	38	15	35	15	23	10	10	26	3	25	21	21
HB	125	190	250	270	300	180	275	300	350	200	325	200	240	180	180	260	160	250	130	230
Recommend	○										○		○		○		○		○	

ISO Material Description	N					S					H										
	Aluminum-wrought alloy		Aluminum-cast, alloyed			Copper and Copper Alloys (Bronze / Brass)			Non Metallic Materials		Heat Resistant Super Alloys			Titanium Alloys	Hardened steel	Chilled Cast Iron	Hardened Cast Iron				
VDI 3323	21	22	23	24	25	26	27	28	29	30	31	32	33	34	35	36	37	38	39	40	41
HRc	21	22	23	24	25	26	27	28	29	30	15	30	25	38	34	34	34	55	60	42	55
HB	60	100	75	90	130	110	90	100			200	280	250	350	320	400 Rm	1050 Rm	550	630	400	550
Recommend	◎					◎					◎			◎	◎	◎	◎	◎	◎	◎	◎



PLAIN SHANK **G8A02** SERIES

CARBIDE, 4 FLUTE with EXTENDED NECK

- VOLLHARTMETALL, 4 SCHNEIDEN mit ABGESETZTEM SCHAFTTEIL
- Fraise carbure, 4 dents, détalonnée
- 4 TAGLIENTI CON SCARICO ESTESO

- ▶ Designed to machine high hardened materials.
- ▶ Suitable for dry cutting, high speed cutting thanks to newly developed raw-material and new coating.
- ▶ Excellent workpiece finish.
- ▶ Designed for high precision milling operation.
- ▶ Higher wear-resistance.

- ▶ Geeignet zum Fräsen hochgehärteter Stähle.
- ▶ Geeignet zum Trockenfräsen und HSC-Fräsen dank neuentwickeltem Material und Beschichtung.
- ▶ Excellente Werkstückoberflächen.
- ▶ Geeignet für hochpräzises Fräsen.
- ▶ Höhere Verschleißfestigkeit.

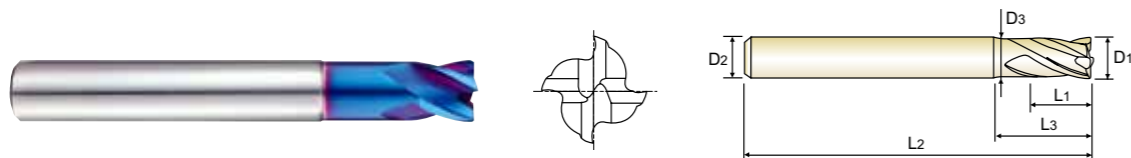

Plain Shank	Page
HYDRAULIC CHUCK SHRINK FIT HOLDER	D15-46 D47-72
POWER MILLING CHUCK	D161-176
ER COLLET CHUCK SK SLIM CHUCK	D73-116 D183-201

Unit : mm

EDP No.	Mill Diameter	Shank Diameter	Length of Cut	Length Below Shank	Overall Length	Neck Diameter
	D1	D2	L1	L3	L2	D3
G8A02010	1.0	6	1.5	3	50	0.95
G8A02020	2.0	6	2	5	50	1.95
G8A02030	3.0	6	3	8	55	2.85
G8A02040	4.0	6	4	10	55	3.85
G8A02050	5.0	6	5	13	55	4.85
G8A02060	6.0	6	6	15	55	5.85
G8A02080	8.0	8	8	20	65	7.7
G8A02100	10.0	10	10	25	75	9.7
G8A02120	12.0	12	12	28	85	11.7
G8A02160	16.0	16	16	32	90	15.7
G8A02200	20.0	20	20	40	105	19.7

Due to the characteristics of the blue decoration layer, it might be erased during short term use and the color layer might not be uniformed. However, it doesn't affect the performance of the tool.

Size	Mill Dia. Tolerance (mm)	Shank Dia. Tolerance
up to Ø6	0 ~ - 0.012	h5
over Ø6	0 ~ - 0.015	

◎ : Excellent ○ : Good

ISO	P										M				K					
	Non-alloy steel					Low alloy steel					High alloyed steel, and tool steel				Stainless steel		Grey cast iron	Nodular cast iron		Malleable cast iron
VDI 3323	1	2	3	4	5	6	7	8	9	10	11	12	13	14	15	16	17	18	19	20
HRc	13	25	28	32	38	10	29	32	38	15	35	15	23	10	10	26	3	25	21	
HB	125	190	250	270	300	180	275	300	350	200	325	200	240	180	180	260	160	250	130	230
Recommend	○										○				○					

ISO	N					S					H											
	Aluminum-wrought alloy		Aluminum-cast, alloyed			Copper and Copper Alloys (Bronze / Brass)			Non Metallic Materials		Heat Resistant Super Alloys			Titanium Alloys	Hardened steel	Chilled Cast Iron	Hardened Cast Iron					
VDI 3323	21	22	23	24	25	26	27	28	29	30	31	32	33	34	35	36	37	38	39	40	41	
HRc	21	22	23	24	25	26	27	28	29	30	15	30	25	38	34	55	60	42	55			
HB	60	100	75	90	130	110	90	100			200	280	250	350	320	400 Rm	1050 Rm	550	630	400	550	
Recommend	◎		◎			◎			◎		◎			◎			◎		◎		◎	



PLAIN SHANK **G8D63** SERIES

CARBIDE, 6&8 FLUTE 45° HELIX LONG LENGTH

- VOLLHARTMETALL, 6&8 SCHNEIDEN 45° RECHTSSPIRALE LANG
- Fraise carbure, 6&8 dents, hélice 45°, longue
- 6&8 TAGLIENTI, ELICA 45°, TAGLIENTE LUNGO

- ▶ Designed to machine high hardened materials.
- ▶ Designed for high abrasion resistance thanks to negative rake angle.
- ▶ Excellent side-cutting of press mold field.

- ▶ Speziell ausgelegt für die Hartbearbeitung
- ▶ Ausgelegt für hohe Abriebfestigkeit dank der negativen Spanwinkel.
- ▶ hervorragend geeignet für die Seitenbearbeitung im Formenbau

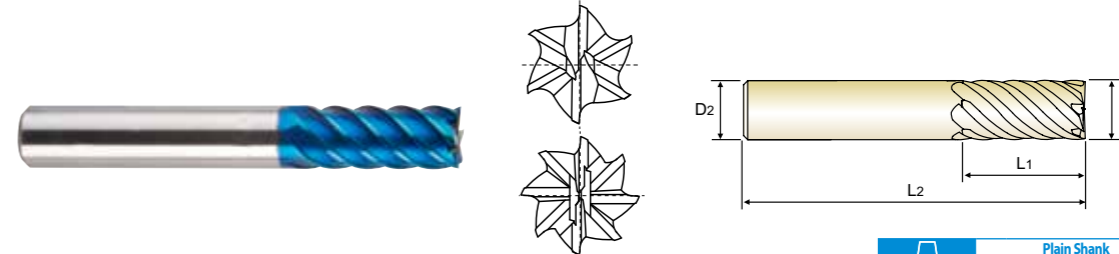

Plain Shank	Page
HYDRAULIC CHUCK SHRINK FIT HOLDER	D15-46 D47-72
POWER MILLING CHUCK	D161-176
ER COLLET CHUCK SK SLIM CHUCK	D73-116 D183-201

Unit : mm

EDP No.	Mill Diameter	Shank Diameter	Length of Cut	Overall Length	No. of Flute
	D1	D2	L1	L2	
G8D63060	6.0	6	13	57	6
G8D63080	8.0	8	19	63	6
G8D63100	10.0	10	22	72	6
G8D63120	12.0	12	26	83	6
G8D63140	14.0	14	26	83	6
G8D63160	16.0	16	32	92	6
G8D63180	18.0	18	32	92	8
G8D63200	20.0	20	38	104	8
G8D63250	25.0	25	44	104	8

Due to the characteristics of the blue decoration layer, it might be erased during short term use and the color layer might not be uniformed. However, it doesn't affect the performance of the tool.

Mill Dia. Tolerance (mm)	Shank Dia. Tolerance
0 ~ - 0.02	h5

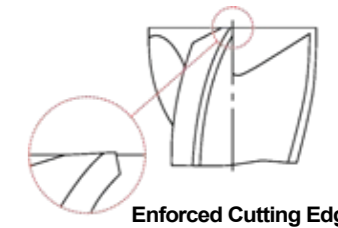

◎ : Excellent ○ : Good

ISO	P										M				K					
	Non-alloy steel					Low alloy steel					High alloyed steel, and tool steel				Stainless steel		Grey cast iron	Nodular cast iron		Malleable cast iron
VDI 3323	1	2	3	4	5	6	7	8	9	10	11	12	13	14	15	16	17	18	19	20
HRc	13	25	28	32	38	10	29	32	38	15	35	15	23	10	10	26	3	25	21	
HB	125	190	250	270	300	180	275	300	350	200	325	200	240	180	180	260	160	250	130	230
Recommend	○										○				○					

ISO	N					S					H											
	Aluminum-wrought alloy		Aluminum-cast, alloyed			Copper and Copper Alloys (Bronze / Brass)			Non Metallic Materials		Heat Resistant Super Alloys			Titanium Alloys	Hardened steel	Chilled Cast Iron	Hardened Cast Iron					
VDI 3323	21	22	23	24	25	26	27	28	29	30	31	32	33	34	35	36	37	38	39	40	41	
HRc	21	22	23	24	25	26	27	28	29	30	15	30	25	38	34	55	60	42	55			
HB	60	100	75	90	130	110	90	100			200	280	250	350	320	400 Rm	1050 Rm	550	630	400	550	
Recommend	◎		◎			◎			◎		◎			◎			◎		◎		◎	

HSS



PLAIN SHANK G8D64 SERIES

CARBIDE, 6&8 FLUTE 45° HELIX EXTRA LONG LENGTH
VOLLHARTMETALL, 6&8 SCHNEIDEN 45° RECHTSSPIRALE EXTRA LANG
Fraise carbure, 6&8 dents, hélice 45°, extra-longue
6&8 TAGLIENTI, ELICA 45°, TAGLIENTE EXTRA LUNGO

- Designed to machine high hardened materials.
Designed for high abrasion resistance thanks to negative rake angle.
Excellent side-cutting of press mold field.
Speziell ausgelegt für die Hartbearbeitung
Ausgelegt für hohe Abriebfestigkeit dank der negativen Spanwinkel.
Hervorragend geeignet für die Seitenbearbeitung im Formenbau

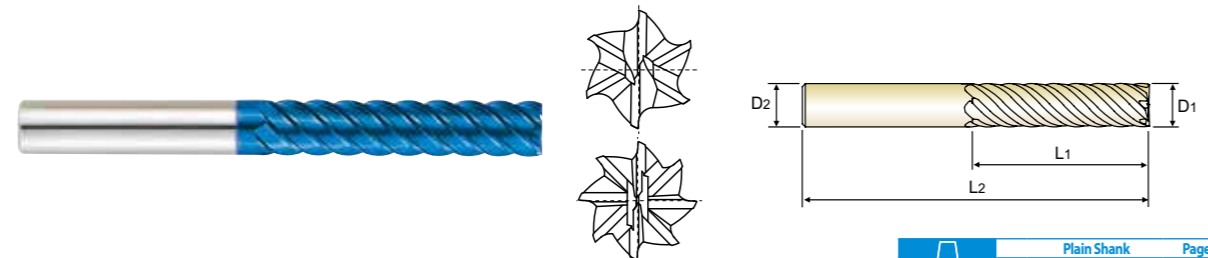

Icons for Carbide, 6&8, 45°, Plain, Blue, and p.C143. Includes Recommended Tool Holder section with hydraulic, power, ER collet, and SK collets.

Table with columns: EDP No., Mill Diameter (D1), Shank Diameter (D2), Length of Cut (L1), Overall Length (L2), No. of Flute. Lists models G8D64060 to G8D64250.

Due to the characteristics of the blue decoration layer, it might be erased during short term use and the color layer might not be uniformed. However, it doesn't affect the performance of the tool.

Table for Mill Dia. Tolerance (mm) and Shank Dia. Tolerance (h5). Mill Dia. tolerance: 0 ~ -0.03.

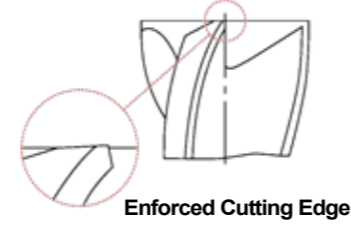

ISO Material Recommendation table. Columns include ISO, Material Description, and various material groups (Non-alloy steel, Low alloy steel, etc.) with numerical recommendations.

HSS



RECOMMENDED CUTTING CONDITIONS
EMPFOHLENE SCHNEIDPARAMETER

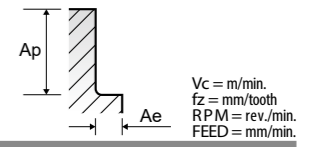

G8B59, G8B54 SERIES 4 FLUTE CORNER RADIUS - SIDE CUTTING

Large data table for High Speed side cutting. Columns: ISO, VDI 3323, Material Description, Ae, Ap, Parameter, and Diameter (Ø) from 2.0 to 16.0 mm.

NORMAL SPEED

Large data table for Normal Speed side cutting. Columns: ISO, VDI 3323, Material Description, Ae, Ap, Parameter, and Diameter (Ø) from 2.0 to 16.0 mm.



RECOMMENDED CUTTING CONDITIONS
EMPFOHLENE SCHNEIDPARAMETER

G8A46, G8A54 SERIES 2 FLUTE BALL NOSE FOR RIB PROCESSING

Vc = m/min.
fz = mm/tooth
RPM = rev./min.
FEED = mm/min.
Ap = mm

Table with columns: ISO, VDI 3323, Material Description, Parameter, Diameter (Ø) (0.2, 0.3, 0.4, 0.5, 0.6). Rows include ISO 5, 8-9, 11.1-11.2, 38.1-38.2, 39.1, 39.2, 40, 41 with various material descriptions and parameters.

▶ NEXT PAGE

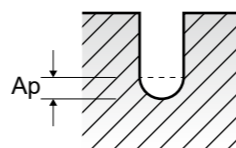

RECOMMENDED CUTTING CONDITIONS
EMPFOHLENE SCHNEIDPARAMETER

G8A46, G8A54 SERIES 2 FLUTE BALL NOSE FOR RIB PROCESSING

Vc = m/min.
fz = mm/tooth
RPM = rev./min.
FEED = mm/min.
Ap = mm

Table with columns: VDI 3323, Parameter, Diameter (Ø) (0.8, 1.0, 1.2, 1.5, 2.0, 3.0, 4.0). Rows include VDI 5, 8-9, 11.1-11.2, 38.1-38.2, 39.1, 39.2, 40, 41 with various material descriptions and parameters.

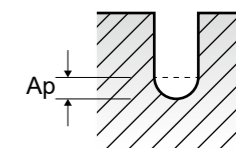



RECOMMENDED CUTTING CONDITIONS
EMPFOHLENE SCHNEIDPARAMETER

G8A28, G8A38, G8A53 SERIES 2 FLUTE BALL NOSE

Vc = m/min.
fz = mm/tooth
RPM = rev./min.
FEED = mm/min.

Table with columns for ISO, VDI 3323, Material Description, Ae, Ap, Parameter, and Diameter (Ø) with sub-columns for 0.2, 0.3, 0.4, 0.5, 0.6, 0.8, 1.0. Rows include material types like Non-alloy steel, Low alloy steel, High alloyed steel, Hardened steel, Chilled Cast Iron, and Hardened Cast Iron.

▶ NEXT PAGE

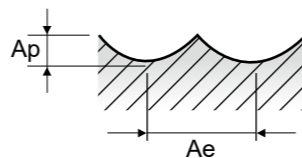

RECOMMENDED CUTTING CONDITIONS
EMPFOHLENE SCHNEIDPARAMETER

G8A28, G8A38, G8A53 SERIES 2 FLUTE BALL NOSE

Vc = m/min.
fz = mm/tooth
RPM = rev./min.
FEED = mm/min.

Table with columns for VDI 3323, Parameter, and Diameter (Ø) with sub-columns for 1.2, 1.5, 2.0, 3.0, 4.0, 5.0, 6.0, 8.0, 10.0, 12.0, 16.0, 20.0. Rows include material types like Non-alloy steel, Low alloy steel, High alloyed steel, Hardened steel, Chilled Cast Iron, and Hardened Cast Iron.

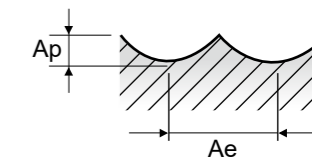

G8A59 SERIES 3 FLUTE BALL NOSE

Vc = m/min.
fz = mm/tooth
RPM = rev./min.
FEED = mm/min.

ISO	VDI 3323	Material Description	Ae	Ap	Parameter	Diameter (Ø)									
						3.0	4.0	5.0	6.0	8.0	10.0	12.0	16.0	20.0	
P	5	Non-alloy steel	0.05D	0.02D	Vc	300	305	315	340	340	340	340	335	340	
					fz	0.09	0.107	0.121	0.159	0.181	0.202	0.225	0.229	0.222	
					RPM	31831	24271	20054	18038	13528	10823	9019	6665	5411	
	8-9	Low alloy steel	0.05D	0.02D	Vc	300	305	315	340	340	340	340	335	340	
					fz	0.09	0.107	0.121	0.159	0.181	0.202	0.225	0.229	0.222	
					RPM	31831	24271	20054	18038	13528	10823	9019	6665	5411	
	11.1 - 11.2	High alloyed steel, and tool steel	0.05D	0.02D	Vc	300	305	315	340	340	340	340	335	340	
					fz	0.09	0.107	0.121	0.159	0.181	0.202	0.225	0.229	0.222	
					RPM	31831	24271	20054	18038	13528	10823	9019	6665	5411	
H	38.1 - 38.2	Hardened steel	0.05D	0.02D	Vc	255	255	265	285	285	285	285	285	285	
					fz	0.072	0.09	0.108	0.136	0.155	0.168	0.187	0.19	0.192	
					RPM	27056	20292	16870	15120	11340	9072	7560	5670	4536	
					FEED	5844	5479	5466	6169	5273	4572	4241	3232	2613	
					Vc	185	185	195	230	230	230	230	230	230	
					fz	0.072	0.087	0.099	0.123	0.144	0.156	0.173	0.18	0.18	
	39.1	Hardened steel	0.05D	0.02D	RPM	19629	14722	12414	12202	9151	7321	6101	4576	3661	
					FEED	4240	3842	3687	4502	3953	3426	3166	2471	1977	
					Vc	175	180	185	210	210	210	210	210	205	
					fz	0.072	0.086	0.099	0.115	0.134	0.144	0.145	0.144	0.145	
					RPM	18568	14324	11777	11141	8356	6685	5570	4178	3263	
					FEED	4011	3696	3498	3844	3359	2888	2423	1805	1419	
	39.2	Hardened steel	0.05D	0.02D	Vc	120	120	125	145	145	145	145	145	145	
					fz	0.072	0.087	0.099	0.108	0.125	0.144	0.144	0.144	0.143	
					RPM	12732	9549	7958	7692	5769	4615	3846	2885	2308	
					FEED	2750	2492	2363	2492	2164	1994	1662	1246	990	
					Vc	300	305	315	340	340	340	340	335	340	
					fz	0.09	0.107	0.121	0.159	0.181	0.202	0.225	0.229	0.222	
39.3	Hardened steel	0.05D	0.02D	RPM	31831	24271	20054	18038	13528	10823	9019	6665	5411		
				FEED	8594	7791	7279	8604	7346	6558	6088	4579	3604		
				Vc	255	255	265	285	285	285	285	285	285		
				fz	0.072	0.09	0.108	0.136	0.155	0.168	0.187	0.19	0.192		
				RPM	27056	20292	16870	15120	11340	9072	7560	5670	4536		
				FEED	5844	5479	5466	6169	5273	4572	4241	3232	2613		
40	Chilled Cast Iron	0.05D	0.02D	Vc	300	305	315	340	340	340	340	335	340		
				fz	0.09	0.107	0.121	0.159	0.181	0.202	0.225	0.229	0.222		
				RPM	31831	24271	20054	18038	13528	10823	9019	6665	5411		
				FEED	8594	7791	7279	8604	7346	6558	6088	4579	3604		
				Vc	255	255	265	285	285	285	285	285	285		
				fz	0.072	0.09	0.108	0.136	0.155	0.168	0.187	0.19	0.192		
41	Hardened Cast Iron	0.05D	0.02D	RPM	27056	20292	16870	15120	11340	9072	7560	5670	4536		
				FEED	5844	5479	5466	6169	5273	4572	4241	3232	2613		

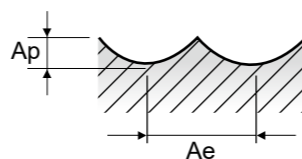

G8D62 SERIES 4 FLUTE BALL NOSE

Vc = m/min.
fz = mm/tooth
RPM = rev./min.
FEED = mm/min.

ISO	VDI 3323	Material Description	Ae	Ap	Parameter	Diameter (Ø)									
						3.0	4.0	5.0	6.0	8.0	10.0	12.0	16.0	20.0	
P	5	Non-alloy steel	0.05D	0.02D	Vc	340	340	340	340	340	340	340	340	340	
					fz	0.071	0.08	0.09	0.101	0.116	0.128	0.145	0.144	0.144	
					RPM	36075	27056	21645	18038	13528	10823	9019	6764	5411	
	8-9	Low alloy steel	0.05D	0.02D	Vc	340	340	340	340	340	340	340	340	340	
					fz	0.071	0.08	0.09	0.101	0.116	0.128	0.145	0.144	0.144	
					RPM	36075	27056	21645	18038	13528	10823	9019	6764	5411	
	11.1 - 11.2	High alloyed steel, and tool steel	0.05D	0.02D	Vc	340	340	340	340	340	340	340	340	340	
					fz	0.071	0.08	0.09	0.101	0.116	0.128	0.145	0.144	0.144	
					RPM	36075	27056	21645	18038	13528	10823	9019	6764	5411	
H	38.1 - 38.2	Hardened steel	0.05D	0.02D	Vc	285	285	280	285	285	285	285	285	285	
					fz	0.06	0.07	0.081	0.092	0.103	0.111	0.125	0.129	0.126	
					RPM	30239	22680	17825	15120	11340	9072	7560	5670	4536	
					FEED	7257	6350	5775	5564	4672	4028	3780	2926	2286	
					Vc	230	230	230	230	230	230	230	230	230	
					fz	0.05	0.06	0.071	0.082	0.096	0.104	0.115	0.119	0.119	
	39.1	Hardened steel	0.05D	0.02D	RPM	24404	18303	14642	12202	9151	7321	6101	4576	3661	
					FEED	4881	4393	4158	4002	3514	3046	2806	2178	1743	
					Vc	210	210	210	210	210	210	210	210	205	
					fz	0.045	0.055	0.067	0.077	0.089	0.095	0.097	0.096	0.096	
					RPM	22282	16711	13369	11141	8356	6685	5570	4178	3263	
					FEED	4011	3676	3583	3431	2975	2540	2161	1604	1253	
	39.2	Hardened steel	0.05D	0.02D	Vc	145	145	145	145	145	145	145	145	145	
					fz	0.04	0.05	0.062	0.072	0.082	0.096	0.094	0.096	0.097	
					RPM	15385	11539	9231	7692	5769	4615	3846	2885	2228	
					FEED	2462	2308	2289	2215	1892	1772	1446	1108	864	
					Vc	340	340	340	340	340	340	340	340	340	
					fz	0.071	0.08	0.09	0.101	0.116	0.128	0.145	0.144	0.144	
39.3	Hardened steel	0.05D	0.02D	RPM	36075	27056	21645	18038	13528	10823	9019	6764	5411		
				FEED	10245	8658	7792	7287	6277	5541	5231	3896	3117		
				Vc	285	285	280	285	285	285	285	285	285		
				fz	0.06	0.07	0.081	0.092	0.103	0.111	0.125	0.129	0.126		
				RPM	30239	22680	17825	15120	11340	9072	7560	5670	4536		
				FEED	7257	6350	5775	5564	4672	4028	3780	2926	2286		
40	Chilled Cast Iron	0.05D	0.02D	Vc	340	340	340	340	340	340	340	340	340		
				fz	0.071	0.08	0.09	0.101	0.116	0.128	0.145	0.144	0.144		
				RPM	36075	27056	21645	18038	13528	10823	9019	6764	5411		
				FEED	10245	8658	7792	7287	6277	5541	5231	3896	3117		
				Vc	285	285	280	285	285	285	285	285	285		
				fz	0.06	0.07	0.081	0.092	0.103	0.111	0.125	0.129	0.126		
41	Hardened Cast Iron	0.05D	0.02D	RPM	30239	22680	17825	15120	11340	9072	7560	5670	4536		
				FEED	7257	6350	5775	5564	4672	4028	3780	2926	2286		

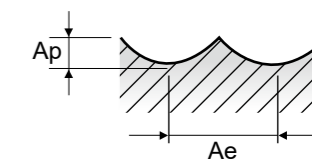

G8A60 SERIES 2 FLUTE CORNER RADIUS - SLOTTING

Vc = m/min, fz = mm/tooth, RPM = rev/min, FEED = mm/min.

Table with columns for ISO, VDI 3323, Material Description, Ae, Ap, Parameter (Vc, fz, RPM, FEED), and Diameter (Ø) from 0.5 to 12.0. Rows are categorized by P (5, 8-9, 11.1, 11.2) and H (38.1, 38.2, 39.1, 39.2, 39.3, 40, 41).

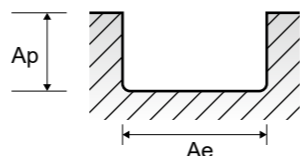

G8A60 SERIES 2 FLUTE CORNER RADIUS - SIDE CUTTING

Vc = m/min, fz = mm/tooth, RPM = rev/min, FEED = mm/min.

Table with columns for ISO, VDI 3323, Material Description, Ae, Ap, Parameter (Vc, fz, RPM, FEED), and Diameter (Ø) from 0.5 to 12.0. Rows are categorized by P (5, 8-9, 11.1, 11.2) and H (38.1, 38.2, 39.1, 39.2, 39.3, 40, 41).

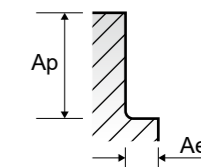

G8A47, G8B08 SERIES

4 FLUTE CORNER RADIUS - SIDE CUTTING

Vc = m/min.
fz = mm/tooth
RPM = rev./min.
FEED = mm/min.

ISO	VDI 3323	Material Description	Ae	Ap	Parameter	Diameter (Ø)																																																							
						1.0	2.0	3.0	4.0	5.0	6.0	8.0	10.0	12.0	16.0	20.0																																													
P	5	Non-alloy steel	0.03D	1.0D	Vc	150	210	205	210	245	245	250	245	250	245	245	fz	0.006	0.011	0.016	0.022	0.025	0.03	0.038	0.045	0.053	0.061	0.067	RPM	47746	33423	21751	16711	15597	12998	9947	7799	6631	4874	3899	FEED	1146	1471	1392	1471	1560	1560	1512	1404	1406	1189	1045									
					8-9	Low alloy steel	0.03D	1.0D	Vc	150	210	205	210	245	245	250	245	250	245	245	fz	0.006	0.011	0.016	0.022	0.025	0.03	0.038	0.045	0.053	0.061	0.067	RPM	47746	33423	21751	16711	15597	12998	9947	7799	6631	4874	3899	FEED	1146	1471	1392	1471	1560	1560	1512	1404	1406	1189	1045					
									11.1	High alloyed steel, and tool steel	0.03D	1.0D	Vc	150	210	205	210	245	245	250	245	250	245	245	fz	0.006	0.011	0.016	0.022	0.025	0.03	0.038	0.045	0.053	0.061	0.067	RPM	47746	33423	21751	16711	15597	12998	9947	7799	6631	4874	3899	FEED	1146	1471	1392	1471	1560	1560	1512	1404	1406	1189	1045	
													11.2	High alloyed steel, and tool steel	0.03D	1.0D	Vc	120	165	165	165	195	195	195	195	200	195	195	fz	0.006	0.01	0.014	0.02	0.024	0.027	0.035	0.041	0.048	0.056	0.063	RPM	38197	26261	17507	13130	12414	10345	7759	6207	5305	3879	3104	FEED	917	1050	980	1050	1192	1117	1086	1018
	H	38.1	Hardened steel	0.03D													1.0D	Vc	120	165	165	165	195	195	195	195	200	195	195	fz	0.006	0.01	0.014	0.02	0.024	0.027	0.035	0.041	0.048	0.056	0.063	RPM	38197	26261	17507	13130	12414	10345	7759	6207	5305	3879	3104	FEED	917	1050	980	1050	1192	1117	1086
					38.2	Hardened steel	0.03D	1.0D										Vc	80	110	110	110	130	130	130	130	130	130	130	fz	0.006	0.01	0.015	0.02	0.024	0.028	0.035	0.041	0.048	0.056	0.063	RPM	25465	17507	11671	8754	8276	6897	5173	4138	3448	2586	2069	FEED	611	700	700	700	794	772	724
									39.1	Hardened steel	0.03D	1.0D						Vc	65	90	90	90	100	100	100	100	100	100	100	fz	0.004	0.007	0.011	0.015	0.018	0.021	0.026	0.03	0.036	0.042	0.048	RPM	20690	14324	9549	7162	6366	5305	3979	3183	2653	1989	1592	FEED	331	401	420	430	458	446	414
													39.2	Hardened steel	0.03D	1.0D		Vc	50	70	70	70	80	80	80	80	80	80	80	fz	0.003	0.006	0.009	0.012	0.015	0.017	0.021	0.024	0.029	0.034	0.038	RPM	15915	11141	7427	5570	5093	4244	3183	2546	2122	1592	1273	FEED	191	267	267	267	306	289	267
		39.3	Hardened steel	0.03D													1.0D	Vc	40	60	60	60	70	70	70	70	70	70	70	fz	0.003	0.005	0.007	0.01	0.012	0.014	0.017	0.02	0.024	0.029	0.033	RPM	12732	9549	6366	4775	4456	3714	2785	2228	1857	1393	1114	FEED	153	191	178	191	214	208	189
					40	Chilled Cast Iron	0.03D	1.0D										Vc	120	165	165	165	195	195	195	195	200	195	195	fz	0.006	0.01	0.014	0.02	0.024	0.027	0.035	0.041	0.048	0.056	0.063	RPM	38197	26261	17507	13130	12414	10345	7759	6207	5305	3879	3104	FEED	917	1050	980	1050	1192	1117	1086
									41	Hardened Cast Iron	0.03D	1.0D						Vc	80	110	110	110	130	130	130	130	130	130	130	fz	0.006	0.01	0.015	0.02	0.024	0.028	0.035	0.041	0.048	0.056	0.063	RPM	25465	17507	11671	8754	8276	6897	5173	4138	3448	2586	2069	FEED	611	700	700	700	794	772	724

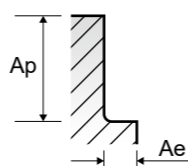

G8A45 SERIES

2 FLUTE for RIB PROCESSING - SLOTTING

Vc = m/min.
fz = mm/tooth
RPM = rev./min.
FEED = mm/min.

ISO	VDI 3323	Material Description	Parameter	Diameter (Ø)																														
				0.2	0.3	0.4	0.5	0.6	0.8																									
P	5	Non-alloy steel	Vc	31	41~47	39~63	40~52	39~66	41~66	fz	0.003~0.004	0.004~0.004	0.006~0.006	0.007~0.007	0.008~0.008	0.011~0.011	RPM	50000	43000~50000	31400~50000	25650~33000	20900~35200	16150~26400	FEED	300~350	330~420	350~590	370~470	330~560	360~590				
			8-9	Low alloy steel	Vc	31	41~47	39~63	40~52	39~66	41~66	fz	0.003~0.004	0.004~0.004	0.006~0.006	0.007~0.007	0.008~0.008	0.011~0.011	RPM	50000	43000~50000	31400~50000	25650~33000	20900~35200	16150~26400	FEED	300~350	330~420	350~590	370~470	330~560	360~590		
					11.1 - 11.2	High alloyed steel, and tool steel	Vc	31	41~47	39~63	40~52	39~66	41~66	fz	0.003~0.004	0.004~0.004	0.006~0.006	0.007~0.007	0.008~0.008	0.011~0.011	RPM	50000	43000~50000	31400~50000	25650~33000	20900~35200	16150~26400	FEED	300~350	330~420	350~590	370~470	330~560	360~590
							38.1 - 38.2	Hardened steel	Vc	31	38~44	38~44	37~41	38~41	38~42	fz	0.003~0.003	0.003~0.003	0.005~0.005	0.006~0.006	0.007~0.007	0.009~0.009	RPM	50000	39900~46200	30500~35200	23750~26000	19900~22000	15200~16700	FEED	265~310	265~310	295~340	285~315
	39.1 - 39.2	Hardened steel							Vc	31	23~30	23~31	22~28	22~29	23~29	fz	0.002~0.003	0.002~0.003	0.003~0.004	0.004~0.004	0.004~0.004	0.006~0.005	RPM	50000	23900~32300	18300~24600	14200~18000	11900~15500	9000~11700	FEED	225~265	105~185	120~200	115~130
			40	Chilled Cast Iron					Vc	31	41~47	39~63	40~52	39~66	41~66	fz	0.003~0.004	0.004~0.004	0.006~0.006	0.007~0.007	0.008~0.008	0.011~0.011	RPM	50000	43000~50000	31400~50000	25650~33000	20900~35200	16150~26400	FEED	300~350	330~420	350~590	370~470
					41	Hardened Cast Iron			Vc	31	38~44	38~44	37~41	38~41	38~42	fz	0.003~0.003	0.003~0.003	0.005~0.005	0.006~0.006	0.007~0.007	0.009~0.009	RPM	50000	39900~46200	30500~35200	23750~26000	19900~22000	15200~16700	FEED	265~310	265~310	295~340	285~315

▶ NEXT PAGE

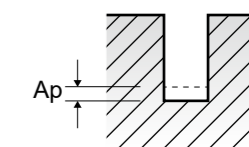



RECOMMENDED CUTTING CONDITIONS
EMPFOHLENE SCHNEIDPARAMETER

G8A02, G8A37 SERIES 4 FLUTE - SIDE CUTTING

Vc = m/min.
fz = mm/tooth
RPM = rev./min.
FEED = mm/min.

Table with columns: ISO, VDI 3323, Material Description, Ae, Ap, Parameter, Diameter (Ø) [1.0, 2.0, 3.0, 4.0, 5.0, 6.0, 8.0, 10.0, 12.0, 16.0, 20.0]. Rows include categories P and H with various material types like Non-alloy steel, Low alloy steel, High alloyed steel, Hardened steel, Chilled Cast Iron, and Hardened Cast Iron.

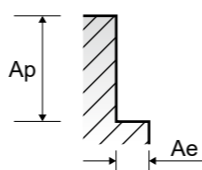

RECOMMENDED CUTTING CONDITIONS
EMPFOHLENE SCHNEIDPARAMETER

G8A39 SERIES 6 FLUTE - SIDE CUTTING

Vc = m/min.
fz = mm/tooth
RPM = rev./min.
FEED = mm/min.

Table with columns: ISO, VDI 3323, Material Description, Ae, Ap, Parameter, Diameter (Ø) [6.0, 8.0, 10.0, 12.0, 16.0, 20.0]. Rows include categories P and H with various material types like Non-alloy steel, Low alloy steel, High alloyed steel, Hardened steel, Chilled Cast Iron, and Hardened Cast Iron.

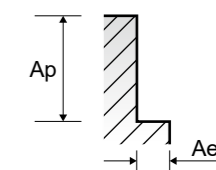

G8D63 SERIES 6&8 FLUTE LONG LENGTH - SIDE CUTTING

Vc = m/min.
fz = mm/tooth
RPM = rev./min.
FEED = mm/min.

ISO	VDI 3323	Material Description	Ae	Ap	Parameter	Diameter (Ø)								
						6.0	8.0	10.0	12.0	14.0	16.0	18.0	20.0	25.0
P	5	Non-alloy steel	0.04D	1.5D	Vc	120	120	120	120	120	120	120	120	125
					fz	0.039	0.052	0.063	0.07	0.081	0.09	0.095	0.08	0.11
					RPM	6366	4775	3820	3183	2728	2387	2122	1910	1592
					FEED	1490	1490	1444	1337	1326	1289	1613	1222	1401
	8-9	Low alloy steel	0.04D	1.5D	Vc	120	120	120	120	120	120	120	125	
					fz	0.039	0.052	0.063	0.07	0.081	0.09	0.095	0.08	0.11
					RPM	6366	4775	3820	3183	2728	2387	2122	1910	1592
					FEED	1490	1490	1444	1337	1326	1289	1613	1222	1401
	11.1	High alloyed steel, and tool steel	0.04D	1.5D	Vc	120	120	120	120	120	120	120	125	
					fz	0.039	0.052	0.063	0.07	0.081	0.09	0.095	0.08	0.11
					RPM	6366	4775	3820	3183	2728	2387	2122	1910	1592
					FEED	1490	1490	1444	1337	1326	1289	1613	1222	1401
11.2	High alloyed steel, and tool steel	0.04D	1.5D	Vc	95	95	95	95	95	95	100	95		
				fz	0.035	0.046	0.055	0.062	0.07	0.079	0.08	0.091	0.096	
				RPM	5040	3780	3024	2520	2160	1890	1680	1592	1210	
				FEED	1058	1043	998	937	907	896	1075	1159	929	
H	38.1 - 38.2	Hardened steel	0.04D	1.5D	Vc	95	95	95	95	95	95	100	95	
					fz	0.035	0.046	0.055	0.062	0.07	0.079	0.08	0.091	0.096
					RPM	5040	3780	3024	2520	2160	1890	1680	1592	1210
					FEED	1058	1043	998	937	907	896	1075	1159	929
	39.1 - 39.2	Hardened steel	0.04D	1.5D	Vc	70	70	70	70	70	70	75	75	
					fz	0.031	0.042	0.05	0.056	0.066	0.072	0.073	0.069	0.087
					RPM	3714	2785	2228	1857	1592	1393	1238	1194	955
					FEED	691	702	668	624	630	602	723	659	665
	39.3	Chilled Cast Iron	0.04D	1.5D	Vc	50	50	50	50	45	50	50	45	50
					fz	0.028	0.037	0.045	0.05	0.051	0.064	0.066	0.071	0.079
					RPM	2653	1989	1592	1326	1023	995	884	716	637
					FEED	446	442	430	398	313	382	467	407	403
40	Chilled Cast Iron	0.04D	1.5D	Vc	95	95	95	95	95	95	100	95		
				fz	0.035	0.046	0.055	0.062	0.07	0.079	0.08	0.091	0.096	
				RPM	5040	3780	3024	2520	2160	1890	1680	1592	1210	
				FEED	1058	1043	998	937	907	896	1075	1159	929	
41	Hardened Cast Iron	0.04D	1.5D	Vc	95	95	95	95	95	95	100	95		
				fz	0.035	0.046	0.055	0.062	0.07	0.079	0.08	0.091	0.096	
				RPM	5040	3780	3024	2520	2160	1890	1680	1592	1210	
				FEED	1058	1043	998	937	907	896	1075	1159	929	

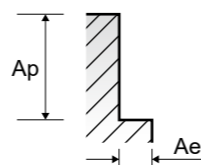

G8D64 SERIES 6&8 FLUTE EXTRA LONG LENGTH - SIDE CUTTING

Vc = m/min.
fz = mm/tooth
RPM = rev./min.
FEED = mm/min.

ISO	VDI 3323	Material Description	Ae	Ap	Parameter	Diameter (Ø)								
						6.0	8.0	10.0	12.0	14.0	16.0	18.0	20.0	25.0
P	5	Non-alloy steel	0.01D	3.0D	Vc	60	60	60	60	60	60	60	60	
					fz	0.04	0.05	0.06	0.07	0.075	0.081	0.085	0.086	0.089
					RPM	3183	2387	1910	1592	1364	1194	1061	955	764
					FEED	764	716	688	669	614	580	721	657	544
	8-9	Low alloy steel	0.01D	3.0D	Vc	60	60	60	60	60	60	60	60	
					fz	0.04	0.05	0.06	0.07	0.075	0.081	0.085	0.086	0.089
					RPM	3183	2387	1910	1592	1364	1194	1061	955	764
					FEED	764	716	688	669	614	580	721	657	544
	11.1	High alloyed steel, and tool steel	0.01D	3.0D	Vc	60	60	60	60	60	60	60	60	
					fz	0.04	0.05	0.06	0.07	0.075	0.081	0.085	0.086	0.089
					RPM	3183	2387	1910	1592	1364	1194	1061	955	764
					FEED	764	716	688	669	614	580	721	657	544
11.2	High alloyed steel, and tool steel	0.01D	3.0D	Vc	60	60	60	60	60	60	60	60		
				fz	0.03	0.04	0.05	0.061	0.066	0.071	0.08	0.09	0.08	
				RPM	3183	2387	1910	1592	1364	1194	1061	955	764	
				FEED	573	573	573	583	540	509	679	688	489	
H	38.1 - 38.2	Hardened steel	0.01D	3.0D	Vc	60	60	60	60	60	60	60	60	
					fz	0.03	0.04	0.05	0.061	0.066	0.071	0.08	0.09	0.08
					RPM	3183	2387	1910	1592	1364	1194	1061	955	764
					FEED	573	573	573	583	540	509	679	688	489
	39.1 - 39.2	Hardened steel	0.01D	3.0D	Vc	50	50	50	50	50	50	50	50	
					fz	0.03	0.04	0.05	0.06	0.066	0.071	0.081	0.091	0.081
					RPM	2653	1989	1592	1326	1137	995	884	796	637
					FEED	478	477	478	477	450	424	573	579	413
	40	Chilled Cast Iron	0.01D	3.0D	Vc	60	60	60	60	60	60	60	60	
					fz	0.03	0.04	0.05	0.061	0.066	0.071	0.08	0.09	0.08
					RPM	3183	2387	1910	1592	1364	1194	1061	955	764
					FEED	573	573	573	583	540	509	679	688	489
41	Hardened Cast Iron	0.01D	3.0D	Vc	60	60	60	60	60	60	60	60		
				fz	0.03	0.04	0.05	0.061	0.066	0.071	0.08	0.09	0.08	
				RPM	3183	2387	1910	1592	1364	1194	1061	955	764	
				FEED	573	573	573	583	540	509	679	688	489	

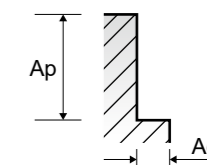



Global Cutting Tool Leader **YG-1**



MILLING



Leading Through Innovation



SOLID CARBIDE

4G Mill END MILLS

4G Mill VHM - FRÄSER

- High Speed Cutting for Pre-Hardened Steels up to HRc55
- Hochgeschwindigkeitsbearbeitung für vorvergehärtete Stähle bis HRc55

SELECTION GUIDE



SOLID CARBIDE
4G Mill
END MILLS

High Speed Cutting
for Pre-Hardened Steels up to HRC55

Please visit
globalyg1.com/mat
for material search

◎ : Excellent ○ : Good

Recommended cutting conditions : p. C260

ISO	VDI 3323	Material Description	Composition / Structure / Heat Treatment	HB	HRc	SEM98	SEM846	SEM846	SEM99
P	1	Non-alloy steel	About 0.15% C Annealed	125		○	○	○	○
	2		About 0.45% C Annealed	190	13	○	○	○	○
	3		About 0.45% C Quenched & Tempered	250	25	○	○	○	◎
	4		About 0.75% C Annealed	270	28	◎	◎	◎	◎
	5	About 0.75% C Quenched & Tempered	300	32	◎	◎	◎	◎	
	6	Low alloy steel	Annealed	180	10	○	○	○	○
	7		Quenched & Tempered	275	29	◎	◎	◎	◎
	8		Quenched & Tempered	300	32	◎	◎	◎	◎
	9		Quenched & Tempered	350	38	◎	◎	◎	◎
	10		High alloyed steel, and tool steel	Annealed	200	15	○	○	○
	11	Quenched & Tempered		325	35	◎	◎	◎	◎
M	12	Stainless steel	Ferritic / Martensitic Annealed	200	15				
	13		Martensitic Quenched & Tempered	240	23				
	14	Austenitic	180	10					
K	15	Grey cast iron	Pearlitic / ferritic	180	10	○	○	○	○
	16		Pearlitic (Martensitic)	260	26	○	○	○	○
	17	Nodular cast iron	Ferritic	160	3	○	○	○	○
	18		Pearlitic	250	25	○	○	○	○
	19		Ferritic	130		○	○	○	○
20	Malleable cast iron	Pearlitic	230	21	○	○	○	○	
N	21	Aluminum-wrought alloy	Not Curable	60					
	22		Curable Hardened	100					
	23	Aluminum-cast, alloyed	≤ 12% Si, Not Curable	75					
	24		≤ 12% Si, Curable Hardened	90					
	25		> 12% Si, Not Curable	130					
	26	Copper and Copper Alloys (PB>1%)	CuZn, CuSnZn (Brass)	110					
	27	Copper and Copper Alloys (Bronze / Brass)	CuSn, lead-free copper and electrolytic copper	100					
	28								
	29	Non Metallic Materials	Duroplastic, Fiber Reinforced Plastic						
30	Rubber, Wood, etc.								
S	31	Heat Resistant Super Alloys	Fe Based Annealed	200	15				
	32		Cured	280	30				
	33		Annealed	250	25				
	34		Ni or Co Based Cured	350	38				
	35		Cast	320	34				
	36	Titanium Alloys	Pure Titanium	400 Rm					
37	Alpha + Beta Alloys	Hardened	1050 Rm						
H	38	Hardened steel	Hardened	550	55	○	○	○	○
	39		Hardened	630	60	○	○	○	○
	40	Chilled Cast Iron	Cast	400	42	◎	◎	◎	◎
	41	Hardened Cast Iron	Hardened	550	55	○	○	○	○

SERIES	SEM98	SEM846	SEM846	SEM99
FLUTE	2	2	2	2
HELIX ANGLE	30°	30°	30°	30°
CUTTING EDGE SHAPE	BALL NOSE	BALL NOSE	BALL NOSE	CORNER RADIUS
SIZE MIN	R0.05	R0.05	R0.25	D0.2
SIZE MAX	R12.5	R6.0	R1.0	D20.0
PAGE	C150	C156	C166	C169

	SEM98	SEM846	SEM846	SEM99
EXTENDED NECK	-	EXTENDED NECK	EXTENDED NECK (6mm Shank)	-
Y-Coating	Y-Coating	Y-Coating	Y-Coating	Y-Coating

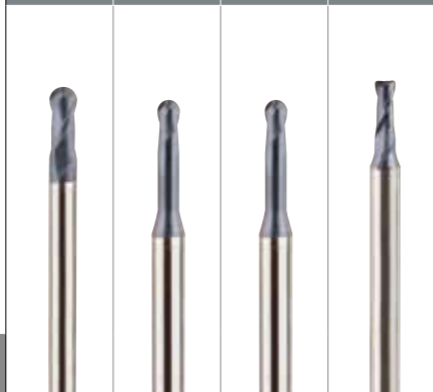

SEME61	SEME01	SEME64	SEME35	SEME35	SEME35	SEME70	SEM845	SEME36	SEME71	SEME72	SEME73	SEME75
2	4	4	2	2	2	2	2	4	4	4	4	6
30°	27°/30° (MULTIPLE HELIX)	27°/30° (MULTIPLE HELIX)	30°	30°	30°	30°	30°	27°/30° (MULTIPLE HELIX)	35°/38° (MULTIPLE HELIX)	30°	30°	45°
CORNER RADIUS	CORNER RADIUS	CORNER RADIUS	SQUARE	SQUARE	SQUARE	SQUARE	SQUARE	SQUARE	SQUARE	SQUARE	SQUARE	SQUARE
D0.2	D1.0	D1.0	D0.1	D0.1	D0.1	D1.0	D0.1	D0.8	D1.0	D1.0	D1.0	D6.0
D20.0	D20.0	D20.0	D25.0	D4.0	D3.0	D25.0	D12.0	D25.0	D20.0	D25.0	D12.0	D20.0
C177	C196	C203	C218	C221	C222	C223	C229	C238	C240	C244	C250	C255
EXTENDED NECK	-	EXTENDED NECK	-	4mm Shank	3mm Shank	LONG LENGTH	EXTENDED NECK	-	Sharp Corner Removal	LONG LENGTH	EXTENDED NECK	-
Y-Coating	Y-Coating	Y-Coating	Y-Coating	Y-Coating	Y-Coating	Y-Coating	Y-Coating	Y-Coating	Y-Coating	Y-Coating	Y-Coating	Y-Coating

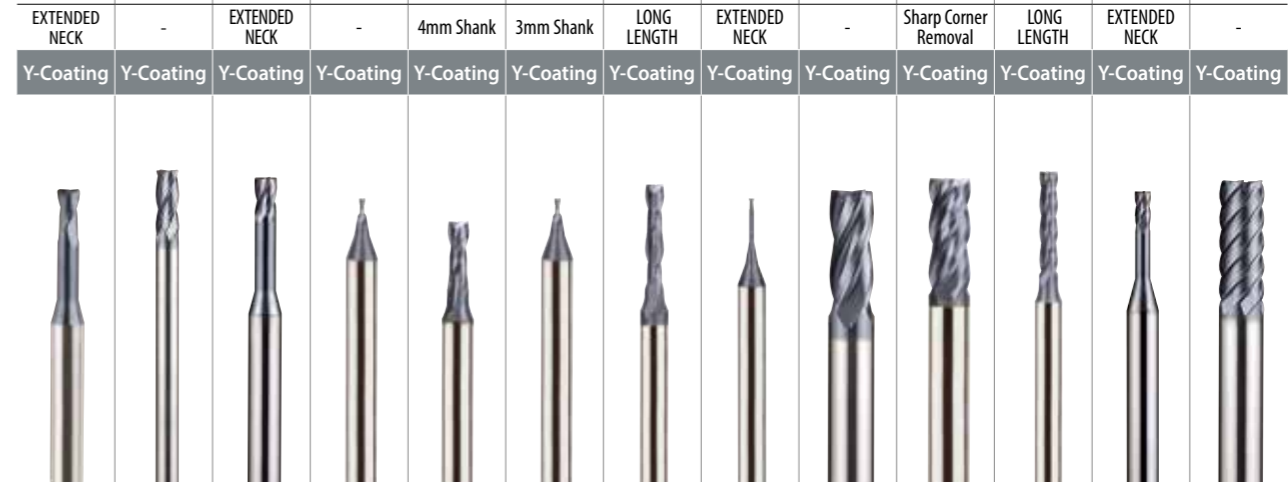

○	○	○	○	○	○	○	○	○	○	○	○	○	1
○	○	◎	○	○	○	○	○	○	○	○	○	○	2
◎	◎	◎	◎	◎	◎	◎	◎	◎	◎	◎	◎	◎	3
◎	◎	◎	◎	◎	◎	◎	◎	◎	◎	◎	◎	◎	4
◎	◎	◎	◎	◎	◎	◎	◎	◎	◎	◎	◎	◎	5
○	○	○	○	○	○	○	○	○	○	○	○	○	6 P
◎	◎	◎	◎	◎	◎	◎	◎	◎	◎	◎	◎	◎	7
◎	◎	◎	◎	◎	◎	◎	◎	◎	◎	◎	◎	◎	8
◎	◎	◎	◎	◎	◎	◎	◎	◎	◎	◎	◎	◎	9
○	○	○	○	○	○	○	○	○	○	○	○	○	10
◎	◎	◎	◎	◎	◎	◎	◎	◎	◎	◎	◎	◎	11
													12
													13 M
													14
○	○	○	○	○	○	○	○	○	○	○	○	○	15
○	○	○	○	○	○	○	○	○	○	○	○	○	16
○	○	○	○	○	○	○	○	○	○	○	○	○	17 K
○	○	○	○	○	○	○	○	○	○	○	○	○	18
○	○	○	○	○	○	○	○	○	○	○	○	○	19
○	○	○	○	○	○	○	○	○	○	○	○	○	20
													21
													22
													23
													24
													25
													26 N
													27
													28
													29
													30
													31
													32
													33
													34 S
													35
													36
													37
○	○	○	○	○	○	○	○	○	○	○	○	○	38
◎	◎	◎	◎	◎	◎	◎	◎	◎	◎	◎	◎	◎	39
◎	◎	◎	◎	◎	◎	◎	◎	◎	◎	◎	◎	◎	40
○	○	○	○	○	○	○	○	○	○	○	○	○	41

SELECTION GUIDE



SERIES	G9D75 G9D67	G9D76 G9D68	G9D77 G9D69
FLUTE	4&5	4&5	4&5
HELIX ANGLE	44°~45° (MULTIPLE HELIX)	44°~45° (MULTIPLE HELIX)	44°~45° (MULTIPLE HELIX)
CUTTING EDGE SHAPE	CORNER RADIUS ROUGHING	CORNER RADIUS ROUGHING	CORNER RADIUS ROUGHING
SIZE MIN	D6.0	D6.0	D6.0
SIZE MAX	D20.0	D20.0	D20.0
PAGE	C257	C258	C259

SOLID CARBIDE
4G Mill
END MILLS

X-SPEED ROUGHER

High Speed Cutting
for Pre-Hardened Steels up to HRc55

SHORT LENGTH	LONG LENGTH	LONG LENGTH
X-Coating	X-Coating	X-Coating



Please visit globalyg1.com/mat for material search

◎ : Excellent ○ : Good

Recommended cutting conditions : p. C260

ISO	VDI 3323	Material Description	Composition / Structure / Heat Treatment	HB	HRc			
P	1	Non-alloy steel	About 0.15% C Annealed	125		○	○	○
	2		About 0.45% C Annealed	190	13	○	○	○
	3		About 0.45% C Quenched & Tempered	250	25	◎	◎	◎
	4		About 0.75% C Annealed	270	28	◎	◎	◎
	5		About 0.75% C Quenched & Tempered	300	32	◎	◎	◎
	6	Low alloy steel	Annealed	180	10	○	○	○
	7		Quenched & Tempered	275	29	◎	◎	◎
	8		Quenched & Tempered	300	32	◎	◎	◎
	9		Quenched & Tempered	350	38	◎	◎	◎
	10		High alloyed steel, and tool steel	Annealed	200	15	○	○
	11	Quenched & Tempered	325	35	◎	◎	◎	
M	12	Stainless steel	Ferritic / Martensitic Annealed	200	15	○	○	○
	13		Martensitic Quenched & Tempered	240	23	○	○	○
	14		Austenitic	180	10	○	○	○
K	15	Grey cast iron	Pearlitic / ferritic	180	10	◎	◎	◎
	16		Pearlitic (Martensitic)	260	26	◎	◎	◎
	17	Nodular cast iron	Ferritic	160	3	◎	◎	◎
	18		Pearlitic	250	25	◎	◎	◎
	19		Ferritic	130		◎	◎	◎
20	Malleable cast iron	Pearlitic	230	21	◎	◎	◎	
N	21	Aluminum-wrought alloy	Not Curable	60				
	22		Curable Hardened	100				
	23	Aluminum-cast, alloyed	≤ 12% Si, Not Curable	75				
	24		≤ 12% Si, Curable Hardened	90				
	25		> 12% Si, Not Curable	130				
	26	Copper and Copper Alloys (Bronze / Brass)	Cutting Alloys, PB>1%	110		○	○	○
	27		CuZn, CuSnZn (Brass)	90		○	○	○
	28	Non Metallic Materials	CuSn, lead-free copper and electrolytic copper	100		○	○	○
	29		Duroplastic, Fiber Reinforced Plastic					
30	Rubber, Wood, etc.							
S	31	Heat Resistant Super Alloys	Fe Based Annealed	200	15			
	32		Cured	280	30			
	33		Annealed	250	25			
	34		Cured	350	38			
	35	Ni or Co Based Cast	320	34				
	36	Titanium Alloys	Pure Titanium	400 Rm				
37	Alpha + Beta Alloys Hardened		1050 Rm					
H	38	Hardened steel	Hardened	550	55			
	39		Hardened	630	60			
	40	Hardened Cast Iron	Cast	400	42			
	41		Hardened	550	55			

X-SPEED ROUGHER

CHARACTERISTICS

Unique flute design for excellent chip evacuation and vibration reduction.
Optimal roughing tooth profile to reduce cutting forces.
Special tool geometry for high feed rate and heavy cutting.
Strong end tooth design for plunge and pocket milling.
Custom engineered coating to allow long tool life and excellent chip evacuation.

▶ 4 FLUTE

▶ 5 FLUTE

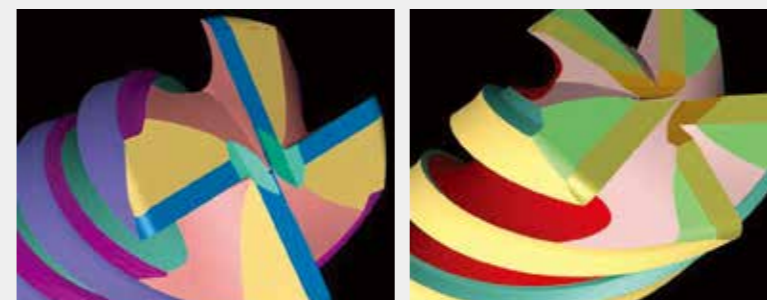

CHIP THICKNESS AND SHAPE

▶ Conventional Roughing End Mills

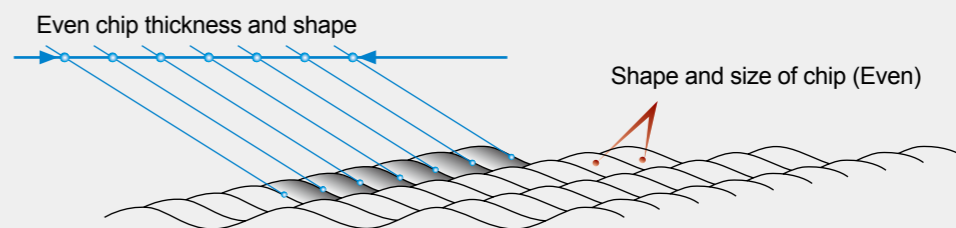

▶ X-SPEED Rougher

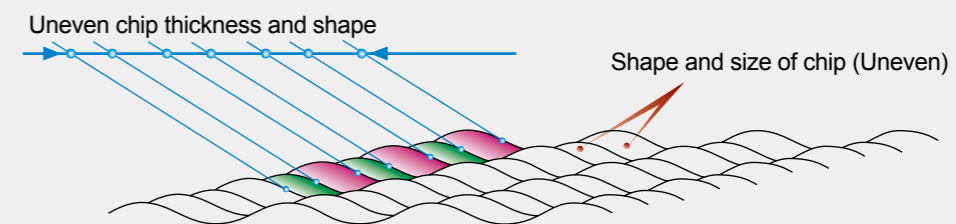

CARBIDE, 2 FLUTE BALL NOSE (Short, Regular, Long Shank)

- VOLLHARTMETALL, 2 SCHNEIDEN STIRNRADIUS
- () Fraise carbure, 2 dents, hémisphérique
- () MD, 2 TAGLIENTI, SEMISFERICA (Serie corta, media e lunga)

▶ New coating and tool geometry applied resulting outstanding cutting abilities and wear resistance.
 ▶ With its unique ball nose geometry and cutting edges the cutting force has decreased, also increasing wear resistance.
 ▶ Excellent performance when cutting prehardened steels, up to HRC55 which are used for molds & dies.

▶ Aufgrund einer neuartigen Beschichtung und neuer Werkzeuggeometrien hervorragende Schnittleistung und Verschleißfestigkeit.
 ▶ Aufgrund der einzigartigen Kugelgeometrie und Schneidkantenpräparation wird die Schnittkraft reduziert und die Verschleißfestigkeit erhöht.
 ▶ Hervorragende Leistung bei der Zerspaltung von vorvergüteten Stählen bis HRC55, welche im Werkzeug- und Formenbau Verwendung finden.

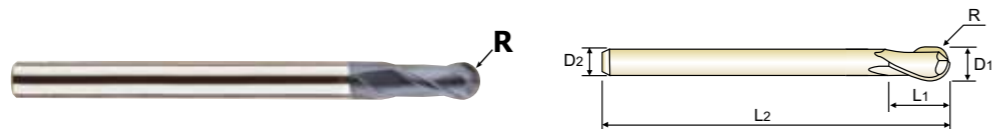

CARBIDE 2 30° R ±0.005 R ±0.010 PLAIN Coating Y p.C260-261

Flat Shank	Page	Plain Shank	Page
END MILL HOLDER	D118-137	HYDRAULIC CHUCK SHRINK FIT HOLDER	D15-46 D47-72
-	-	POWER MILLING CHUCK	D161-176
-	-	ER COLLET CHUCK SK SLIM CHUCK	D73-116 D183-201

R0.05-R3 R325-R125

Unit : mm

EDP No.	Radius of Ball Nose	Mill Diameter	Shank Diameter	Length of Cut	Overall Length	Remark
	R	D1	D2	L1	L2	
★ SEMD98001SE	R0.05	0.1	4	0.1	40	Short
★ SEMD98001E	R0.05	0.1	4	0.2	40	Regular
SEMD980013SE	R0.05	0.1	3	0.2	40	3mm Shank
SEMD980015SE	R0.075	0.15	4	0.15	40	Short
SEMD980015E	R0.075	0.15	4	0.3	40	Regular
SEMD9800153SE	R0.075	0.15	3	0.3	40	3mm Shank
★ SEMD98002SE	R0.1	0.2	4	0.2	40	Short
★ SEMD98002E	R0.1	0.2	4	0.4	40	Regular
SEMD980023SE	R0.1	0.2	3	0.4	40	3mm Shank
★ SEMD98003SE	R0.15	0.3	4	0.3	40	Short
★ SEMD98003E	R0.15	0.3	4	0.6	40	Regular
SEMD980033SE	R0.15	0.3	3	0.6	40	3mm Shank
SEMD98004SE	R0.2	0.4	4	0.4	40	Short
★ SEMD98004E	R0.2	0.4	4	0.8	40	Regular
SEMD980043SE	R0.2	0.4	3	0.8	40	3mm Shank
★ SEMD98005SE	R0.25	0.5	4	0.5	40	Short
SEMD98005S6SE	R0.25	0.5	6	0.8	40	-
★ SEMD98005E	R0.25	0.5	4	1.0	40	Regular
SEMD980053SE	R0.25	0.5	3	1.0	40	3mm Shank
SEMD98006SE	R0.3	0.6	4	0.6	40	Short
★ SEMD98006E	R0.3	0.6	4	1.2	40	Regular
SEMD980063SE	R0.3	0.6	3	1.2	40	3mm Shank
SEMD98007SE	R0.35	0.7	4	0.7	40	Short
★ SEMD98007E	R0.35	0.7	4	1.4	40	Regular

★ : Stock Item

▶ NEXT PAGE

Size	Radius Tolerance (mm)	Mill Dia. Tolerance (mm)	Shank Dia. Tolerance
up to R3	± 0.005	0 ~ - 0.012	h5
over R3	± 0.010	0 ~ - 0.015	

◎ : Excellent ○ : Good

ISO Material Description	P										M						K																								
	Non-alloy steel					Low alloy steel					High alloyed steel, and tool steel		Stainless steel				Grey cast iron		Nodular cast iron		Malleable cast iron																				
VDI 3323	1	2	3	4	5	6	7	8	9	10	11	12	13	14	15	16	17	18	19	20	21	22	23	24	25	26	27	28	29	30	31	32	33	34	35	36	37	38	39	40	41
HRC	13	25	28	32	30	29	32	38	35	35	35	15	23	10	10	26	3	25	21	21	15	30	25	38	34	200	325	200	240	180	10	26	3	25	250	130	230				
HB	125	190	250	270	300	180	275	300	350	200	325	200	240	180	180	260	160	250	130	230	180	260	160	250	130	230	200	325	200	240	180	10	26	3	25	250	130	230			
Recommend	○	○	○	◎	◎	○	◎	◎	◎	◎	◎	○	○	○	○	○	○	○	○	○	○	○	○	◎	◎	◎	◎	◎	◎	◎	◎	◎	◎	◎	◎	◎	◎	◎	◎	◎	

CARBIDE, 2 FLUTE BALL NOSE (Short, Regular, Long Shank)

- VOLLHARTMETALL, 2 SCHNEIDEN STIRNRADIUS
- () Fraise carbure, 2 dents, hémisphérique
- () MD, 2 TAGLIENTI, SEMISFERICA (Serie corta, media e lunga)

▶ New coating and tool geometry applied resulting outstanding cutting abilities and wear resistance.
 ▶ With its unique ball nose geometry and cutting edges the cutting force has decreased, also increasing wear resistance.
 ▶ Excellent performance when cutting prehardened steels, up to HRC55 which are used for molds & dies.

▶ Aufgrund einer neuartigen Beschichtung und neuer Werkzeuggeometrien hervorragende Schnittleistung und Verschleißfestigkeit.
 ▶ Aufgrund der einzigartigen Kugelgeometrie und Schneidkantenpräparation wird die Schnittkraft reduziert und die Verschleißfestigkeit erhöht.
 ▶ Hervorragende Leistung bei der Zerspaltung von vorvergüteten Stählen bis HRC55, welche im Werkzeug- und Formenbau Verwendung finden.

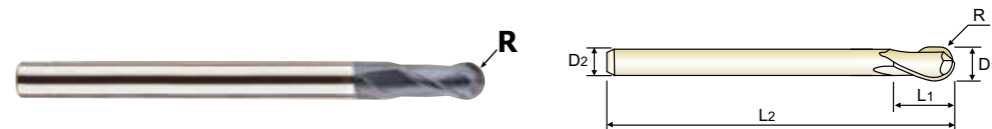

CARBIDE 2 30° R ±0.005 R ±0.010 PLAIN Coating Y p.C260-261

Flat Shank	Page	Plain Shank	Page
END MILL HOLDER	D118-137	HYDRAULIC CHUCK SHRINK FIT HOLDER	D15-46 D47-72
-	-	POWER MILLING CHUCK	D161-176
-	-	ER COLLET CHUCK SK SLIM CHUCK	D73-116 D183-201

R0.05-R3 R325-R125

Unit : mm

EDP No.	Radius of Ball Nose	Mill Diameter	Shank Diameter	Length of Cut	Overall Length	Remark
	R	D1	D2	L1	L2	
SEMD980073SE	R0.35	0.7	3	1.4	40	3mm Shank
SEMD98008SE	R0.4	0.8	4	0.8	40	Short
★ SEMD98008E	R0.4	0.8	4	1.6	40	Regular
SEMD980083SE	R0.4	0.8	3	1.6	40	3mm Shank
SEMD98009SE	R0.45	0.9	4	0.9	40	Short
★ SEMD98009E	R0.45	0.9	4	1.8	40	Regular
SEMD980093SE	R0.45	0.9	3	1.8	40	3mm Shank
SEMD98010040E	R0.5	1.0	6	1.5	40	Short
SEMD980103SE	R0.5	1.0	3	2.5	50	3mm Shank
SEMD98010S4SE	R0.5	1.0	4	1.5	40	-
★ SEMD980104SE	R0.5	1.0	4	2.5	50	Regular
★ SEMD98010E	R0.5	1.0	6	2.5	50	Regular
★ SEMD98010070E	R0.5	1.0	6	2.5	70	Long Shank
SEMD98010100E	R0.5	1.0	6	2.5	100	Long Shank
SEMD98012040E	R0.6	1.2	6	2	40	Short
SEMD980123SE	R0.6	1.2	3	3	50	3mm Shank
SEMD980124SE	R0.6	1.2	4	3	50	Regular
★ SEMD98012E	R0.6	1.2	6	3	50	Regular
SEMD98012070E	R0.6	1.2	6	3	70	Long Shank
SEMD98012100E	R0.6	1.2	6	3	100	Long Shank
SEMD98015040E	R0.75	1.5	6	2.5	40	Short
SEMD980153SE	R0.75	1.5	3	4	50	3mm Shank
★ SEMD980154SE	R0.75	1.5	4	4	50	Regular
★ SEMD98015E	R0.75	1.5	6	4	50	Regular

★ : Stock Item

▶ NEXT PAGE

Size	Radius Tolerance (mm)	Mill Dia. Tolerance (mm)	Shank Dia. Tolerance
up to R3	± 0.005	0 ~ - 0.012	h5
over R3	± 0.010	0 ~ - 0.015	

◎ : Excellent ○ : Good

ISO Material Description	P										M						K																								
	Non-alloy steel					Low alloy steel					High alloyed steel, and tool steel		Stainless steel				Grey cast iron		Nodular cast iron		Malleable cast iron																				
VDI 3323	1	2	3	4	5	6	7	8	9	10	11	12	13	14	15	16	17	18	19	20	21	22	23	24	25	26	27	28	29	30	31	32	33	34	35	36	37	38	39	40	41
HRC	13	25	28	32	30	29	32	38	35	35	35	15	23	10	10	26	3	25	21	21	15	30	25	38	34	200	325	200	240	180	10	26	3	25	250	130	230				
HB	125	190	250	270	300	180	275	300	350	200	325	200	240	180	180	260	160	250	130	230	180	260	160	250	130	230	200	325	200	240	180	10	26	3	25	250	130	230			
Recommend	○	○	○	◎	◎	○	◎	◎	◎	◎	◎	○	○	○	○	○	○	○	○	○	○	○	○	◎	◎	◎	◎	◎	◎	◎	◎	◎	◎	◎	◎	◎	◎	◎	◎	◎	



PLAIN SHANK SEMD98 SERIES

CARBIDE, 2 FLUTE BALL NOSE (Short, Regular, Long Shank)

- VOLLHARTMETALL, 2 SCHNEIDEN STIRNRADIUS
- (●) Fraise carbure, 2 dents, hémisphérique
- (●) MD, 2 TAGLIENTI, SEMISFERICA (Serie corta, media e lunga)

- ▶ New coating and tool geometry applied resulting outstanding cutting abilities and wear resistance.
- ▶ With its unique ball nose geometry and cutting edges the cutting force has decreased, also increasing wear resistance.
- ▶ Excellent performance when cutting prehardened steels, up to HRC55 which are used for molds & dies.

- ▶ Aufgrund einer neuartigen Beschichtung und neuer Werkzeuggeometrien hervorragende Schnittleistung und Verschleißfestigkeit.
- ▶ Aufgrund der einzigartigen Kugelgeometrie und Schneidkantenpräparation wird die Schnittkraft reduziert und die Verschleißfestigkeit erhöht.
- ▶ Hervorragende Leistung bei der Zerspaltung von vorvergüteten Stählen bis HRC55, welche im Werkzeug- und Formenbau Verwendung finden.

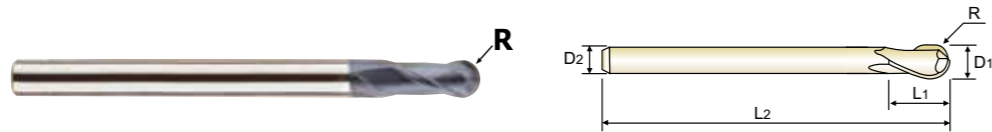

CARBIDE 2 30° R ±0.005 R ±0.010 PLAIN Coating Y p.C260-261 Recommended ToolHolder

Flat Shank	Page	Plain Shank	Page
END MILL HOLDER	D118-137	HYDRAULIC CHUCK SHRINK FIT HOLDER	D15-46 D47-72
-	-	POWER MILLING CHUCK	D161-176
-	-	ER COLLET CHUCK SK SLIM CHUCK	D73-116 D183-201

R0.05-R3 R325-R125

Unit : mm

EDP No.	Radius of Ball Nose	Mill Diameter	Shank Diameter	Length of Cut	Overall Length	Remark
	R	D1	D2	L1	L2	
★ SEMD98015070E	R0.75	1.5	6	4	70	Long Shank
SEMD98015100E	R0.75	1.5	6	4	100	Long Shank
★ SEMD98020040E	R1.0	2.0	6	3	40	Short
SEMD9802035E	R1.0	2.0	3	5	50	3mm Shank
★ SEMD9802045E	R1.0	2.0	4	5	50	Regular
★ SEMD98020E	R1.0	2.0	6	5	50	Regular
★ SEMD98020080E	R1.0	2.0	6	5	80	Long Shank
SEMD98020100E	R1.0	2.0	6	5	100	Long Shank
SEMD98025040E	R1.25	2.5	6	4	40	Short
SEMD9802535E	R1.25	2.5	3	6	60	3mm Shank
★ SEMD9802545E	R1.25	2.5	4	6	60	Regular
★ SEMD98025E	R1.25	2.5	6	6	60	Regular
★ SEMD98025080E	R1.25	2.5	6	6	80	Long Shank
SEMD98025100E	R1.25	2.5	6	6	100	Long Shank
★ SEMD98030040E	R1.5	3.0	6	4.5	40	Short
SEMD9803035E	R1.5	3.0	3	6	60	3mm Shank
★ SEMD9803045E	R1.5	3.0	4	6	60	Regular
★ SEMD98030E	R1.5	3.0	6	6	60	Regular
★ SEMD98030080E	R1.5	3.0	6	6	80	Long Shank
★ SEMD98030100E	R1.5	3.0	6	6	100	Long Shank
★ SEMD98035E	R1.75	3.5	6	8	70	-
★ SEMD98040050E	R2.0	4.0	6	6	50	Short
★ SEMD9804045E	R2.0	4.0	4	8	70	Regular
★ SEMD98040E	R2.0	4.0	6	8	70	Regular

★ : Stock Item

▶ NEXT PAGE

Size	Radius Tolerance (mm)	Mill Dia. Tolerance (mm)	Shank Dia. Tolerance
up to R3	± 0.005	0 ~ - 0.012	h5
over R3	± 0.010	0 ~ - 0.015	

◎ : Excellent ○ : Good

ISO Material Description	P										M						K					
	Non-alloy steel					Low alloy steel					High alloyed steel, and tool steel		Stainless steel				Grey cast iron		Nodular cast iron		Malleable cast iron	
VDI 3323	1	2	3	4	5	6	7	8	9	10	11	12	13	14	15	16	17	18	19	20		
HRC	13	25	28	32	30	29	32	38	35	35	15	23	10	10	26	3	25	21				
HB	125	190	250	270	300	180	275	300	350	200	325	200	240	180	180	260	160	250	130	230		
Recommend	○	○	○	◎	◎	○	◎	◎	◎	◎	◎	○	○	○	○	○	○	○	○	○	○	

ISO Material Description	N										S						H						
	Aluminum-wrought alloy		Aluminum-cast, alloyed				Copper and Copper Alloys (Bronze / Brass)				Non Metallic Materials		Heat Resistant Super Alloys				Titanium Alloys		Hardened steel		Chilled Cast Iron		Hardened Cast Iron
VDI 3323	21	22	23	24	25	26	27	28	29	30	31	32	33	34	35	36	37	38	39	40	41		
HRC											15	30	25	38	34			55	60	42	55		
HB	60	100	75	90	130	110	90	100			200	280	250	350	320	400 Rm	1050 Rm	550	630	400	550		
Recommend											○	○	○	○	○	○	○	○	○	◎	○		



PLAIN SHANK SEMD98 SERIES

CARBIDE, 2 FLUTE BALL NOSE (Short, Regular, Long Shank)

- VOLLHARTMETALL, 2 SCHNEIDEN STIRNRADIUS
- (●) Fraise carbure, 2 dents, hémisphérique
- (●) MD, 2 TAGLIENTI, SEMISFERICA (Serie corta, media e lunga)

- ▶ New coating and tool geometry applied resulting outstanding cutting abilities and wear resistance.
- ▶ With its unique ball nose geometry and cutting edges the cutting force has decreased, also increasing wear resistance.
- ▶ Excellent performance when cutting prehardened steels, up to HRC55 which are used for molds & dies.

- ▶ Aufgrund einer neuartigen Beschichtung und neuer Werkzeuggeometrien hervorragende Schnittleistung und Verschleißfestigkeit.
- ▶ Aufgrund der einzigartigen Kugelgeometrie und Schneidkantenpräparation wird die Schnittkraft reduziert und die Verschleißfestigkeit erhöht.
- ▶ Hervorragende Leistung bei der Zerspaltung von vorvergüteten Stählen bis HRC55, welche im Werkzeug- und Formenbau Verwendung finden.

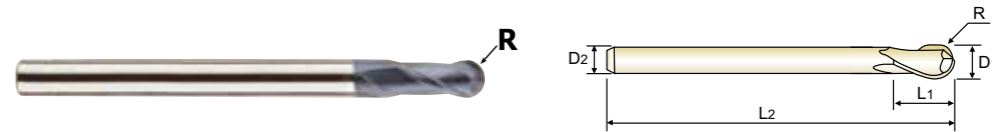

CARBIDE 2 30° R ±0.005 R ±0.010 PLAIN Coating Y p.C260-261 Recommended ToolHolder

Flat Shank	Page	Plain Shank	Page
END MILL HOLDER	D118-137	HYDRAULIC CHUCK SHRINK FIT HOLDER	D15-46 D47-72
-	-	POWER MILLING CHUCK	D161-176
-	-	ER COLLET CHUCK SK SLIM CHUCK	D73-116 D183-201

R0.05-R3 R325-R125

Unit : mm

EDP No.	Radius of Ball Nose	Mill Diameter	Shank Diameter	Length of Cut	Overall Length	Remark
	R	D1	D2	L1	L2	
★ SEMD980401004SE	R2.0	4.0	4	8	100	Long Shank
SEMD980401204SE	R2.0	4.0	4	8	120	Long Shank
★ SEMD98040100E	R2.0	4.0	6	8	100	Long Shank
★ SEMD98040120E	R2.0	4.0	6	8	120	Long Shank
★ SEMD98045E	R2.25	4.5	6	9	80	-
★ SEMD98050060E	R2.5	5.0	6	7.5	60	Short
★ SEMD98050E	R2.5	5.0	6	10	80	Regular
SEMD9805055E	R2.5	5.0	5	10	80	5mmShank
★ SEMD98055E	R2.75	5.5	6	11	90	-
★ SEMD98060050E	R3.0	6.0	6	9	50	Short
★ SEMD98060060E	R3.0	6.0	6	9	60	Short
★ SEMD98060080E	R3.0	6.0	6	9	80	Short
★ SEMD98060E	R3.0	6.0	6	12	90	Regular
★ SEMD98060110E	R3.0	6.0	6	12	110	Long Shank
★ SEMD98060130E	R3.0	6.0	6	12	130	Long Shank
★ SEMD98060150E	R3.0	6.0	6	12	150	Long Shank
★ SEMD98065E	R3.25	6.5	8	13	90	-
★ SEMD98070E	R3.5	7.0	8	14	90	-
★ SEMD98080050E	R4.0	8.0	8	12	50	Short
★ SEMD98080060E	R4.0	8.0	8	12	60	Short
★ SEMD98080080E	R4.0	8.0	8	12	80	Short
★ SEMD98080090E	R4.0	8.0	8	12	90	Short
★ SEMD98080E	R4.0	8.0	8	14	100	Regular
★ SEMD98080130E	R4.0	8.0	8	14	130	Long Shank

★ : Stock Item

▶ NEXT PAGE

Size	Radius Tolerance (mm)	Mill Dia. Tolerance (mm)	Shank Dia. Tolerance
up to R3	± 0.005	0 ~ - 0.012	h5
over R3	± 0.010	0 ~ - 0.015	

◎ : Excellent ○ : Good

ISO Material Description	P										M						K					
	Non-alloy steel					Low alloy steel					High alloyed steel, and tool steel		Stainless steel				Grey cast iron		Nodular cast iron		Malleable cast iron	
VDI 3323	1	2	3	4	5	6	7	8	9	10	11	12	13	14	15	16	17	18	19	20		
HRC	13	25	28	32	30	29	32	38	35	35	15	23	10	10	26	3	25	21				
HB	125	190	250	270	300	180	275	300	350	200	325	200	240	180	180	260	160	250	130	230		
Recommend	○	○	○	◎	◎	○	◎	◎	◎	◎	◎	○	○	○	○	○	○	○	○	○	○	

ISO Material Description	N										S						H						
	Aluminum-wrought alloy		Aluminum-cast, alloyed				Copper and Copper Alloys (Bronze / Brass)				Non Metallic Materials		Heat Resistant Super Alloys				Titanium Alloys		Hardened steel		Chilled Cast Iron		Hardened Cast Iron
VDI 3323	21	22	23	24	25	26	27	28	29	30	31	32	33	34	35	36	37	38	39	40	41		
HRC											15	30	25	38	34			55	60	42	55		
HB	60	100	75	90	130	110	90	100			200	280	250	350	320	400 Rm	1050 Rm	550	630	400	550		
Recommend											○	○	○	○	○	○	○	○	○	◎	○		



PLAIN SHANK SEMD98 SERIES

CARBIDE, 2 FLUTE BALL NOSE (Short, Regular, Long Shank)

- VOLLHARTMETALL, 2 SCHNEIDEN STIRNRADIUS
- Fraise carbure, 2 dents, hémisphérique
- MD, 2 TAGLIENTI, SEMISFERICA (Serie corta, media e lunga)

- ▶ New coating and tool geometry applied resulting outstanding cutting abilities and wear resistance.
- ▶ With its unique ball nose geometry and cutting edges the cutting force has decreased, also increasing wear resistance.
- ▶ Excellent performance when cutting prehardened steels, up to HRC55 which are used for molds & dies.

- ▶ Aufgrund einer neuartigen Beschichtung und neuer Werkzeuggeometrien hervorragende Schnittleistung und Verschleißfestigkeit.
- ▶ Aufgrund der einzigartigen Kugelgeometrie und Schneidkantenpräparation wird die Schnittkraft reduziert und die Verschleißfestigkeit erhöht.
- ▶ Hervorragende Leistung bei der Zerspaltung von vorvergüteten Stählen bis HRC55, welche im Werkzeug- und Formenbau Verwendung finden.

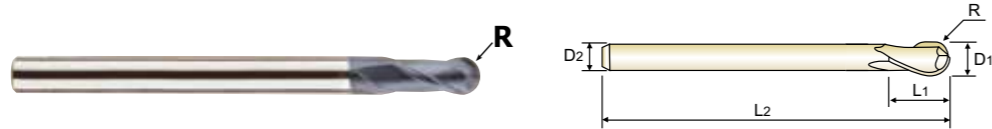

CARBIDE 2 30° R ±0.005 R ±0.010 PLAIN Coating Y p.C260-261 Recommended ToolHolder

Flat Shank	Page	Plain Shank	Page
END MILL HOLDER	D118-137	HYDRAULIC CHUCK SHRINK FIT HOLDER	D15-46 D47-72
-	-	POWER MILLING CHUCK	D161-176
-	-	ER COLLET CHUCK SK SLIM CHUCK	D73-116 D183-201

R0.05-R3 R325-R125

Unit : mm

EDP No.	Radius of Ball Nose	Mill Diameter	Shank Diameter	Length of Cut	Overall Length	Remark
	R	D1	D2	L1	L2	
★ SEMD98080150E	R4.0	8.0	8	14	150	Long Shank
★ SEMD98085E	R4.25	8.5	10	16	100	-
★ SEMD98090E	R4.5	9.0	10	18	100	-
SEMD98100050E	R5.0	10.0	10	15	50	Short
★ SEMD98100060E	R5.0	10.0	10	15	60	Short
★ SEMD98100080E	R5.0	10.0	10	15	80	Short
★ SEMD98100090E	R5.0	10.0	10	15	90	Short
★ SEMD98100E	R5.0	10.0	10	18	100	Regular
★ SEMD98100130E	R5.0	10.0	10	18	130	Long Shank
★ SEMD98100150E	R5.0	10.0	10	18	150	Long Shank
★ SEMD98100180E	R5.0	10.0	10	18	180	Long Shank
SEMD98100200E	R5.0	10.0	10	18	200	Long Shank
★ SEMD98110E	R5.5	11.0	12	20	100	-
SEMD98120060E	R6.0	12.0	12	18	60	Short
★ SEMD98120080E	R6.0	12.0	12	18	80	Short
SEMD98120090E	R6.0	12.0	12	18	90	Short
★ SEMD98120100E	R6.0	12.0	12	18	100	Short
★ SEMD98120E	R6.0	12.0	12	22	110	Regular
★ SEMD98120130E	R6.0	12.0	12	22	130	Long Shank
★ SEMD98120150E	R6.0	12.0	12	22	150	Long Shank
★ SEMD98120180E	R6.0	12.0	12	22	180	Long Shank
★ SEMD98120200E	R6.0	12.0	12	22	200	Long Shank
★ SEMD98130E	R6.5	13.0	12	24	100	-
★ SEMD98140E	R7.0	14.0	12	26	100	Regular

★ : Stock Item

▶ NEXT PAGE

Size	Radius Tolerance (mm)	Mill Dia. Tolerance (mm)	Shank Dia. Tolerance
up to R3	± 0.005	0 ~ - 0.012	h5
over R3	± 0.010	0 ~ - 0.015	

◎ : Excellent ○ : Good

ISO Material Description	P										M						K					
	Non-alloy steel					Low alloy steel					High alloyed steel, and tool steel		Stainless steel				Grey cast iron		Nodular cast iron		Malleable cast iron	
VDI 3323	1	2	3	4	5	6	7	8	9	10	11	12	13	14	15	16	17	18	19	20		
HRc	13	25	28	32	30	29	32	38	35	35	15	23	10	10	26	3	25	21	21			
HB	125	190	250	270	300	180	275	300	350	200	325	200	240	180	180	260	160	250	130	230		
Recommend	○	○	○	◎	◎	○	◎	◎	◎	◎	◎	○	○	○	○	○	○	○	○	○	○	

ISO Material Description	N										S						H						
	Aluminum-wrought alloy		Aluminum-cast, alloyed				Copper and Copper Alloys (Bronze / Brass)				Non Metallic Materials		Heat Resistant Super Alloys				Titanium Alloys		Hardened steel		Chilled Cast Iron		Hardened Cast Iron
VDI 3323	21	22	23	24	25	26	27	28	29	30	31	32	33	34	35	36	37	38	39	40	41		
HRc	15	30	25	38	34	15	30	25	38	34	15	30	25	38	34	55	60	42	42	55	55		
HB	60	100	75	90	130	110	90	100			200	280	250	350	320	400 Rm	1050 Rm	550	630	400	550		
Recommend											○	○	○	○	○	○	○	○	○	○	○	○	



PLAIN SHANK SEMD98 SERIES

CARBIDE, 2 FLUTE BALL NOSE (Short, Regular, Long Shank)

- VOLLHARTMETALL, 2 SCHNEIDEN STIRNRADIUS
- Fraise carbure, 2 dents, hémisphérique
- MD, 2 TAGLIENTI, SEMISFERICA (Serie corta, media e lunga)

- ▶ New coating and tool geometry applied resulting outstanding cutting abilities and wear resistance.
- ▶ With its unique ball nose geometry and cutting edges the cutting force has decreased, also increasing wear resistance.
- ▶ Excellent performance when cutting prehardened steels, up to HRC55 which are used for molds & dies.

- ▶ Aufgrund einer neuartigen Beschichtung und neuer Werkzeuggeometrien hervorragende Schnittleistung und Verschleißfestigkeit.
- ▶ Aufgrund der einzigartigen Kugelgeometrie und Schneidkantenpräparation wird die Schnittkraft reduziert und die Verschleißfestigkeit erhöht.
- ▶ Hervorragende Leistung bei der Zerspaltung von vorvergüteten Stählen bis HRC55, welche im Werkzeug- und Formenbau Verwendung finden.

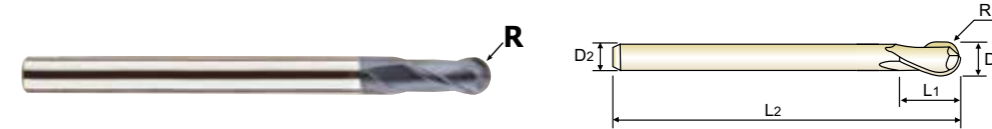

CARBIDE 2 30° R ±0.005 R ±0.010 PLAIN Coating Y p.C260-261 Recommended ToolHolder

Flat Shank	Page	Plain Shank	Page
END MILL HOLDER	D118-137	HYDRAULIC CHUCK SHRINK FIT HOLDER	D15-46 D47-72
-	-	POWER MILLING CHUCK	D161-176
-	-	ER COLLET CHUCK SK SLIM CHUCK	D73-116 D183-201

R0.05-R3 R325-R125

Unit : mm

EDP No.	Radius of Ball Nose	Mill Diameter	Shank Diameter	Length of Cut	Overall Length	Remark
	R	D1	D2	L1	L2	
★ SEMD9814014SE	R7.0	14.0	14	26	100	-
SEMD9814016SE	R7.0	14.0	16	26	100	-
SEMD98150E	R7.5	15.0	16	28	140	-
★ SEMD98160100E	R8.0	16.0	16	24	100	Short
SEMD98160130E	R8.0	16.0	16	24	130	Short
★ SEMD98160E	R8.0	16.0	16	30	150	Regular
SEMD98160180E	R8.0	16.0	16	30	180	Long Shank
★ SEMD98160200E	R8.0	16.0	16	30	200	Long Shank
★ SEMD98180E	R9.0	18.0	16	34	150	Regular
SEMD9818018SE	R9.0	18.0	18	34	150	-
★ SEMD98200100E	R10.0	20.0	20	30	100	Short
SEMD98200130E	R10.0	20.0	20	30	130	Short
★ SEMD98200E	R10.0	20.0	20	38	150	Regular
SEMD98200200E	R10.0	20.0	20	38	200	Long Shank
SEMD98250120E	R12.5	25.0	25	50	120	Short
SEMD98250E	R12.5	25.0	25	50	180	Regular

★ : Stock Item

Size	Radius Tolerance (mm)	Mill Dia. Tolerance (mm)	Shank Dia. Tolerance
up to R3	± 0.005	0 ~ - 0.012	h5
over R3	± 0.010	0 ~ - 0.015	

◎ : Excellent ○ : Good

ISO Material Description	P										M						K					
	Non-alloy steel					Low alloy steel					High alloyed steel, and tool steel		Stainless steel				Grey cast iron		Nodular cast iron		Malleable cast iron	
VDI 3323	1	2	3	4	5	6	7	8	9	10	11	12	13	14	15	16	17	18	19	20		
HRc	13	25	28	32	30	29	32	38	35	35	15	23	10	10	26	3	25	21	21			
HB	125	190	250	270	300	180	275	300	350	200	325	200	240	180	180	260	160	250	130	230		
Recommend	○	○	○	◎	◎	○	◎	◎	◎	◎	◎	○	○	○	○	○	○	○	○	○	○	

ISO Material Description	N										S						H						
	Aluminum-wrought alloy		Aluminum-cast, alloyed				Copper and Copper Alloys (Bronze / Brass)				Non Metallic Materials		Heat Resistant Super Alloys				Titanium Alloys		Hardened steel		Chilled Cast Iron		Hardened Cast Iron
VDI 3323	21	22	23	24	25	26	27	28	29	30	31	32	33	34	35	36	37	38	39	40	41		
HRc	15	30	25	38	34	15	30	25	38	34	15	30	25	38	34	55	60	42	42	55	55		
HB	60	100	75	90	130	110	90	100			200	280	250	350	320	400 Rm	1050 Rm	550	630	400	550		
Recommend											○	○	○	○	○	○	○	○	○	○	○	○	



PLAIN SHANK SEM846 SERIES

CARBIDE, 2 FLUTE BALL NOSE with EXTENDED NECK

- VOLLHARTMETALL, 2 SCHNEIDEN STIRNRADIUS mit LANG ABGESETZTEM SCHAFTTETL
Fraise carbure, 2 dents, hémisphérique, détalonnée
MD, 2 TAGLIENTI, SEMISFERICA, SCARICATA

- New coating and tool geometry applied resulting outstanding cutting abilities and wear resistance.
With its unique ball nose geometry and cutting edges the cutting force has decreased, also increasing wear resistance.
Excellent performance when cutting prehardened steels, up to HRc55 which are used for molds & dies.

- Aufgrund einer neuartigen Beschichtung und neuer Werkzeuggeometrien hervorragende Schnittleistung und Verschleißfestigkeit.
Aufgrund der einzigartigen Kugelgeometrie und Schneidkantenpräparation wird die Schnittkraft reduziert und die Verschleißfestigkeit erhöht.
Hervorragende Leistung bei der Zerspaltung von vorvergüteten Stählen bis HRc55, welche im Werkzeug- und Formenbau Verwendung finden.

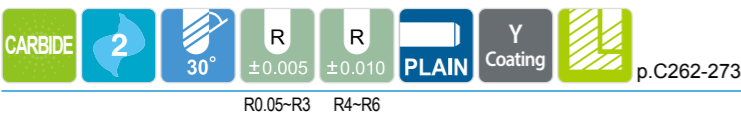
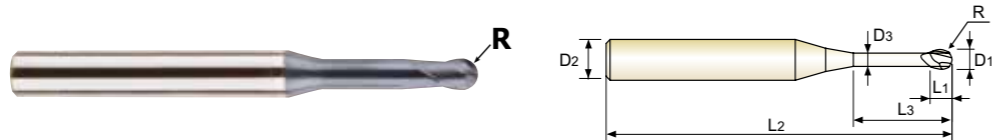

Table with 4 columns: Flat Shank, Page, Plain Shank, Page. Lists recommended tool holders like END MILL HOLDER, HYDRAULIC CHUCK, etc.

R0.05-R3 R4-R6

Unit : mm

Main product table with columns: EDP No., Radius of Ball Nose, Mill Diameter, Shank Diameter, Length of Cut, Length Below Shank, Overall Length, Neck Diameter. Lists various SEM84600 series end mills.

★ : Stock Item

▶ NEXT PAGE

Table with 4 columns: Size, Radius Tolerance (mm), Mill Dia. Tolerance (mm), Shank Dia. Tolerance. Shows tolerances for up to R3 and over R3.

◎ : Excellent ○ : Good

ISO material compatibility chart with columns for P (Non-alloy steel, Low alloy steel, High alloyed steel, Stainless steel), M (Grey cast iron, Nodular cast iron, Malleable cast iron), N (Aluminum-wrought alloy, Aluminum-cast, alloyed), S (Copper and Copper Alloys, Non Metallic Materials), H (Heat Resistant Super Alloys, Titanium Alloys, Hardened steel, Chilled Cast Iron, Hardened Cast Iron).



PLAIN SHANK SEM846 SERIES

CARBIDE, 2 FLUTE BALL NOSE with EXTENDED NECK

- VOLLHARTMETALL, 2 SCHNEIDEN STIRNRADIUS mit LANG ABGESETZTEM SCHAFTTETL
Fraise carbure, 2 dents, hémisphérique, détalonnée
MD, 2 TAGLIENTI, SEMISFERICA, SCARICATA

- New coating and tool geometry applied resulting outstanding cutting abilities and wear resistance.
With its unique ball nose geometry and cutting edges the cutting force has decreased, also increasing wear resistance.
Excellent performance when cutting prehardened steels, up to HRc55 which are used for molds & dies.

- Aufgrund einer neuartigen Beschichtung und neuer Werkzeuggeometrien hervorragende Schnittleistung und Verschleißfestigkeit.
Aufgrund der einzigartigen Kugelgeometrie und Schneidkantenpräparation wird die Schnittkraft reduziert und die Verschleißfestigkeit erhöht.
Hervorragende Leistung bei der Zerspaltung von vorvergüteten Stählen bis HRc55, welche im Werkzeug- und Formenbau Verwendung finden.

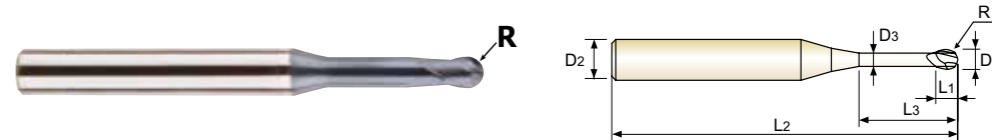

Table with 4 columns: Flat Shank, Page, Plain Shank, Page. Lists recommended tool holders like END MILL HOLDER, HYDRAULIC CHUCK, etc.

R0.05-R3 R4-R6

Unit : mm

Main product table with columns: EDP No., Radius of Ball Nose, Mill Diameter, Shank Diameter, Length of Cut, Length Below Shank, Overall Length, Neck Diameter. Lists various SEM84600 series end mills.

★ : Stock Item

▶ NEXT PAGE

Table with 4 columns: Size, Radius Tolerance (mm), Mill Dia. Tolerance (mm), Shank Dia. Tolerance. Shows tolerances for up to R3 and over R3.

◎ : Excellent ○ : Good

ISO material compatibility chart with columns for P (Non-alloy steel, Low alloy steel, High alloyed steel, Stainless steel), M (Grey cast iron, Nodular cast iron, Malleable cast iron), N (Aluminum-wrought alloy, Aluminum-cast, alloyed), S (Copper and Copper Alloys, Non Metallic Materials), H (Heat Resistant Super Alloys, Titanium Alloys, Hardened steel, Chilled Cast Iron, Hardened Cast Iron).



PLAIN SHANK SEM846 SERIES

CARBIDE, 2 FLUTE BALL NOSE with EXTENDED NECK

● VOLLHARTMETALL, 2 SCHNEIDEN STIRNRADIUS mit LANG ABGESETZTEM SCHAFTTETL
 (●) Fraise carbure, 2 dents, hémisphérique, détalonnée
 (●) MD, 2 TAGLIENTI, SEMISFERICA, SCARICATA

- ▶ New coating and tool geometry applied resulting outstanding cutting abilities and wear resistance.
- ▶ With its unique ball nose geometry and cutting edges the cutting force has decreased, also increasing wear resistance.
- ▶ Excellent performance when cutting prehardened steels, up to HRC55 which are used for molds & dies.

- ▶ Aufgrund einer neuartigen Beschichtung und neuer Werkzeuggeometrien hervorragende Schnittleistung und Verschleißfestigkeit.
- ▶ Aufgrund der einzigartigen Kugelgeometrie und Schneidkantenpräparation wird die Schnittkraft reduziert und die Verschleißfestigkeit erhöht.
- ▶ Hervorragende Leistung bei der Zerspaltung von vorvergüteten Stählen bis HRC55, welche im Werkzeug- und Formenbau Verwendung finden.

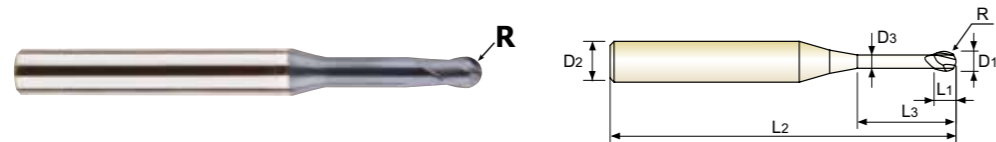

CARBIDE 2 30° R ±0.005 R ±0.010 PLAIN Coating Y p.C262-273

Flat Shank	Page	Plain Shank	Page
END MILL HOLDER	D118-137	HYDRAULIC CHUCK SHRINK FIT HOLDER	D15-46 D47-72
-	-	POWER MILLING CHUCK	D161-176
-	-	ER COLLET CHUCK SK SLIM CHUCK	D73-116 D183-201

EDP No.	Radius of Ball Nose	Mill Diameter	Shank Diameter	Length of Cut	Length Below Shank	Overall Length	Neck Diameter
	R	D1	D2	L1	L3	L2	D3
SEM84600614E	R0.3	0.6	4	0.6	14	45	0.55
SEM84600616E	R0.3	0.6	4	0.6	16	45	0.55
★ SEM84600702E	R0.35	0.7	4	0.7	2	45	0.65
★ SEM84600704E	R0.35	0.7	4	0.7	4	45	0.65
★ SEM84600706E	R0.35	0.7	4	0.7	6	45	0.65
SEM84600708E	R0.35	0.7	4	0.7	8	45	0.65
SEM84600710E	R0.35	0.7	4	0.7	10	45	0.65
SEM84600712E	R0.35	0.7	4	0.7	12	45	0.65
SEM84600801E	R0.4	0.8	4	0.8	1	45	0.75
★ SEM84600802E	R0.4	0.8	4	0.8	2	45	0.75
★ SEM84600803E	R0.4	0.8	4	0.8	3	45	0.75
★ SEM84600804E	R0.4	0.8	4	0.8	4	45	0.75
★ SEM84600805E	R0.4	0.8	4	0.8	5	45	0.75
★ SEM84600806E	R0.4	0.8	4	0.8	6	45	0.75
★ SEM84600808E	R0.4	0.8	4	0.8	8	45	0.75
★ SEM84600810E	R0.4	0.8	4	0.8	10	45	0.75
★ SEM84600812E	R0.4	0.8	4	0.8	12	45	0.75
SEM84600814E	R0.4	0.8	4	0.8	14	45	0.75
SEM84600816E	R0.4	0.8	4	0.8	16	45	0.75
SEM84600820E	R0.4	0.8	4	0.8	20	45	0.75
★ SEM84600904E	R0.45	0.9	4	0.9	4	45	0.85
SEM84600906E	R0.45	0.9	4	0.9	6	45	0.85
★ SEM84600908E	R0.45	0.9	4	0.9	8	45	0.85
SEM84600910E	R0.45	0.9	4	0.9	10	45	0.85

★ : Stock Item ▶ NEXT PAGE

Size	Radius Tolerance (mm)	Mill Dia. Tolerance (mm)	Shank Dia. Tolerance
up to R3	± 0.005	0 ~ - 0.012	h5
over R3	± 0.010	0 ~ - 0.015	

◎ : Excellent ○ : Good

ISO Material Description	P										M						K					
	Non-alloy steel					Low alloy steel					High alloyed steel, and tool steel		Stainless steel				Grey cast iron		Nodular cast iron		Malleable cast iron	
VDI 3323	1	2	3	4	5	6	7	8	9	10	11	12	13	14	15	16	17	18	19	20		
HRc	13	25	28	32	38	10	29	32	38	15	35	15	23	10	10	26	3	25	21	21		
HB	125	190	250	270	300	180	275	300	350	200	325	200	240	180	180	260	160	250	130	230		
Recommend	○	○	○	◎	◎	○	◎	◎	◎	◎	◎	○	○	○	○	○	○	○	○	○	○	



PLAIN SHANK SEM846 SERIES

CARBIDE, 2 FLUTE BALL NOSE with EXTENDED NECK

● VOLLHARTMETALL, 2 SCHNEIDEN STIRNRADIUS mit LANG ABGESETZTEM SCHAFTTETL
 (●) Fraise carbure, 2 dents, hémisphérique, détalonnée
 (●) MD, 2 TAGLIENTI, SEMISFERICA, SCARICATA

- ▶ New coating and tool geometry applied resulting outstanding cutting abilities and wear resistance.
- ▶ With its unique ball nose geometry and cutting edges the cutting force has decreased, also increasing wear resistance.
- ▶ Excellent performance when cutting prehardened steels, up to HRC55 which are used for molds & dies.

- ▶ Aufgrund einer neuartigen Beschichtung und neuer Werkzeuggeometrien hervorragende Schnittleistung und Verschleißfestigkeit.
- ▶ Aufgrund der einzigartigen Kugelgeometrie und Schneidkantenpräparation wird die Schnittkraft reduziert und die Verschleißfestigkeit erhöht.
- ▶ Hervorragende Leistung bei der Zerspaltung von vorvergüteten Stählen bis HRC55, welche im Werkzeug- und Formenbau Verwendung finden.

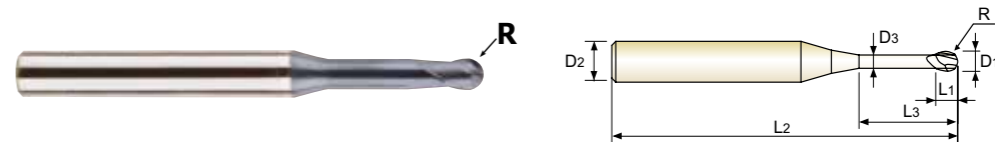

CARBIDE 2 30° R ±0.005 R ±0.010 PLAIN Coating Y p.C262-273

Flat Shank	Page	Plain Shank	Page
END MILL HOLDER	D118-137	HYDRAULIC CHUCK SHRINK FIT HOLDER	D15-46 D47-72
-	-	POWER MILLING CHUCK	D161-176
-	-	ER COLLET CHUCK SK SLIM CHUCK	D73-116 D183-201

EDP No.	Radius of Ball Nose	Mill Diameter	Shank Diameter	Length of Cut	Length Below Shank	Overall Length	Neck Diameter
	R	D1	D2	L1	L3	L2	D3
★ SEM84601002E	R0.5	1.0	4	1	2	50	0.95
★ SEM84601003E	R0.5	1.0	4	1	3	50	0.95
★ SEM84601004E	R0.5	1.0	4	1	4	50	0.95
★ SEM84601005E	R0.5	1.0	4	1	5	50	0.95
★ SEM84601006E	R0.5	1.0	4	1	6	50	0.95
★ SEM84601007E	R0.5	1.0	4	1	7	50	0.95
★ SEM84601008E	R0.5	1.0	4	1	8	50	0.95
SEM84601009E	R0.5	1.0	4	1	9	50	0.95
★ SEM84601010E	R0.5	1.0	4	1	10	50	0.95
★ SEM84601012E	R0.5	1.0	4	1	12	50	0.95
★ SEM84601014E	R0.5	1.0	4	1	14	50	0.95
★ SEM84601016E	R0.5	1.0	4	1	16	50	0.95
★ SEM84601018E	R0.5	1.0	4	1	18	50	0.95
★ SEM84601020E	R0.5	1.0	4	1	20	50	0.95
SEM84601022E	R0.5	1.0	4	1	22	60	0.95
★ SEM84601026E	R0.5	1.0	4	1	26	60	0.95
★ SEM84601030E	R0.5	1.0	4	1	30	70	0.95
SEM84601040E	R0.5	1.0	4	1	40	80	0.95
SEM84601050E	R0.5	1.0	4	1	50	100	0.95
★ SEM84601204E	R0.6	1.2	4	1.2	4	50	1.15
★ SEM84601206E	R0.6	1.2	4	1.2	6	50	1.15
★ SEM84601208E	R0.6	1.2	4	1.2	8	50	1.15
★ SEM84601210E	R0.6	1.2	4	1.2	10	50	1.15
★ SEM84601212E	R0.6	1.2	4	1.2	12	50	1.15

★ : Stock Item ▶ NEXT PAGE

Size	Radius Tolerance (mm)	Mill Dia. Tolerance (mm)	Shank Dia. Tolerance
up to R3	± 0.005	0 ~ - 0.012	h5
over R3	± 0.010	0 ~ - 0.015	

◎ : Excellent ○ : Good

ISO Material Description	P										M						K					
	Non-alloy steel					Low alloy steel					High alloyed steel, and tool steel		Stainless steel				Grey cast iron		Nodular cast iron		Malleable cast iron	
VDI 3323	1	2	3	4	5	6	7	8	9	10	11	12	13	14	15	16	17	18	19	20		
HRc	13	25	28	32	38	10	29	32	38	15	35	15	23	10	10	26	3	25	21	21		
HB	125	190	250	270	300	180	275	300	350	200	325	200	240	180	180	260	160	250	130	230		
Recommend	○	○	○	◎	◎	○	◎	◎	◎	◎	◎	○	○	○	○	○	○	○	○	○	○	



PLAIN SHANK SEM846 SERIES

CARBIDE, 2 FLUTE BALL NOSE with EXTENDED NECK

VOLLHARTMETALL, 2 SCHNEIDEN STIRNRADIUS mit LANG ABGESETZTEM SCHAFTTETL
 () Fraise carbure, 2 dents, hémisphérique, détalonnée
 () MD, 2 TAGLIENTI, SEMISFERICA, SCARICATA

- Due to new coating and new tool geometry, outstanding cutting ability and wear resistance.
 - Due to unique ball nose geometry and cutting edges, cutting force decreased, and so wear resistance increased.
 - Excellent performance when cutting prehardened steels, up to HRC55 which are used for molds & dies.
- Aufgrund einer neuartigen Beschichtung und neuer Werkzeuggeometrien hervorragende Schnittleistung und Verschleißfestigkeit.
 Aufgrund der einzigartigen Kugelgeometrie und Schneidkantenpräparation wird die Schnittkraft reduziert und die Verschleißfestigkeit erhöht.
 Hervorragende Leistung bei der Zerspaltung von vorvergüteten Stählen bis HRC55, welche im Werkzeug- und Formenbau Verwendung finden.

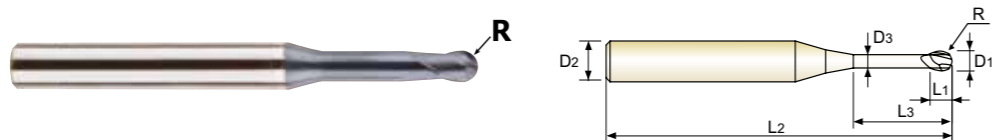

Flat Shank	Page	Plain Shank	Page
END MILL HOLDER	D118-137	HYDRAULIC CHUCK SHRINK FIT HOLDER	D15-46 D47-72
-	-	POWER MILLING CHUCK	D161-176
-	-	ER COLLET CHUCK SK SLIM CHUCK	D73-116 D183-201

R0.05-R3 R4-R6

Unit : mm

EDP No.	Radius of Ball Nose	Mill Diameter	Shank Diameter	Length of Cut	Length Below Shank	Overall Length	Neck Diameter
	R	D1	D2	L1	L3	L2	D3
★ SEM84601216E	R0.6	1.2	4	1.2	16	50	1.15
SEM84601220E	R0.6	1.2	4	1.2	20	50	1.15
SEM84601226E	R0.6	1.2	4	1.2	26	60	1.15
SEM84601406E	R0.7	1.4	4	1.4	6	50	1.35
SEM84601408E	R0.7	1.4	4	1.4	8	50	1.35
SEM84601410E	R0.7	1.4	4	1.4	10	50	1.35
SEM84601412E	R0.7	1.4	4	1.4	12	50	1.35
SEM84601416E	R0.7	1.4	4	1.4	16	50	1.35
★ SEM84601503E	R0.75	1.5	4	1.5	3	50	1.45
★ SEM84601504E	R0.75	1.5	4	1.5	4	50	1.45
★ SEM84601505E	R0.75	1.5	4	1.5	5	50	1.45
★ SEM84601506E	R0.75	1.5	4	1.5	6	50	1.45
SEM84601507E	R0.75	1.5	4	1.5	7	50	1.45
★ SEM84601508E	R0.75	1.5	4	1.5	8	50	1.45
★ SEM84601510E	R0.75	1.5	4	1.5	10	50	1.45
★ SEM84601512E	R0.75	1.5	4	1.5	12	50	1.45
★ SEM84601514E	R0.75	1.5	4	1.5	14	50	1.45
★ SEM84601516E	R0.75	1.5	4	1.5	16	50	1.45
★ SEM84601518E	R0.75	1.5	4	1.5	18	50	1.45
★ SEM84601520E	R0.75	1.5	4	1.5	20	50	1.45
SEM84601522E	R0.75	1.5	4	1.5	22	60	1.45
SEM84601526E	R0.75	1.5	4	1.5	26	60	1.45
SEM84601530E	R0.75	1.5	4	1.5	30	70	1.45
SEM84601535E	R0.75	1.5	4	1.5	35	70	1.45

★ : Stock Item

▶ NEXT PAGE

Size	Radius Tolerance (mm)	Mill Dia. Tolerance (mm)	Shank Dia. Tolerance
up to R3	± 0.005	0 ~ - 0.012	h5
over R3	± 0.010	0 ~ - 0.015	

◎ : Excellent ○ : Good

ISO Material Description	P										M				K						
	Non-alloy steel					Low alloy steel					High alloyed steel, and tool steel		Stainless steel		Grey cast iron		Nodular cast iron		Malleable cast iron		
VDI 3323	1	2	3	4	5	6	7	8	9	10	11	12	13	14	15	16	17	18	19	20	
HRc	13	25	28	32	38	42	48	52	58	62	68	72	78	82	88	92	98	102	108	112	
HB	125	190	250	270	300	180	275	300	350	200	325	200	240	180	180	260	160	250	130	230	
Recommend	○	○	○	◎	◎	○	◎	◎	◎	◎	◎	○	○	○	○	○	○	○	○	○	○



PLAIN SHANK SEM846 SERIES

CARBIDE, 2 FLUTE BALL NOSE with EXTENDED NECK

VOLLHARTMETALL, 2 SCHNEIDEN STIRNRADIUS mit LANG ABGESETZTEM SCHAFTTETL
 () Fraise carbure, 2 dents, hémisphérique, détalonnée
 () MD, 2 TAGLIENTI, SEMISFERICA, SCARICATA

- New coating and tool geometry applied resulting outstanding cutting abilities and wear resistance.
 - With its unique ball nose geometry and cutting edges the cutting force has decreased, also increasing wear resistance.
 - Excellent performance when cutting prehardened steels, up to HRC55 which are used for molds & dies.
- Aufgrund einer neuartigen Beschichtung und neuer Werkzeuggeometrien hervorragende Schnittleistung und Verschleißfestigkeit.
 Aufgrund der einzigartigen Kugelgeometrie und Schneidkantenpräparation wird die Schnittkraft reduziert und die Verschleißfestigkeit erhöht.
 Hervorragende Leistung bei der Zerspaltung von vorvergüteten Stählen bis HRC55, welche im Werkzeug- und Formenbau Verwendung finden.

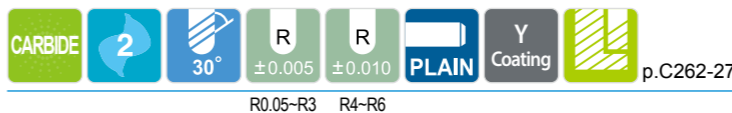
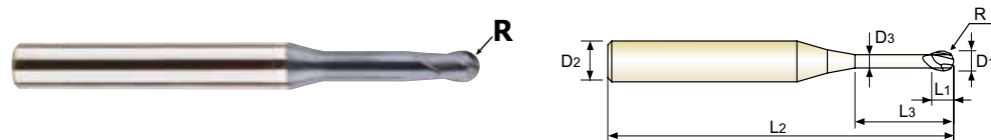

Flat Shank	Page	Plain Shank	Page
END MILL HOLDER	D118-137	HYDRAULIC CHUCK SHRINK FIT HOLDER	D15-46 D47-72
-	-	POWER MILLING CHUCK	D161-176
-	-	ER COLLET CHUCK SK SLIM CHUCK	D73-116 D183-201

R0.05-R3 R4-R6

Unit : mm

EDP No.	Radius of Ball Nose	Mill Diameter	Shank Diameter	Length of Cut	Length Below Shank	Overall Length	Neck Diameter
	R	D1	D2	L1	L3	L2	D3
SEM84601540E	R0.75	1.5	4	1.5	40	80	1.45
SEM84601604E	R0.8	1.6	4	1.6	4	50	1.55
SEM84601606E	R0.8	1.6	4	1.6	6	50	1.55
★ SEM84601608E	R0.8	1.6	4	1.6	8	50	1.55
SEM84601610E	R0.8	1.6	4	1.6	10	50	1.55
★ SEM84601612E	R0.8	1.6	4	1.6	12	50	1.55
★ SEM84601616E	R0.8	1.6	4	1.6	16	50	1.55
SEM84601620E	R0.8	1.6	4	1.6	20	50	1.55
★ SEM84601804E	R0.9	1.8	4	1.8	4	50	1.75
SEM84601806E	R0.9	1.8	4	1.8	6	50	1.75
★ SEM84601808E	R0.9	1.8	4	1.8	8	50	1.75
SEM84601810E	R0.9	1.8	4	1.8	10	50	1.75
★ SEM84601812E	R0.9	1.8	4	1.8	12	50	1.75
★ SEM84601816E	R0.9	1.8	4	1.8	16	50	1.75
SEM84601820E	R0.9	1.8	4	1.8	20	50	1.75
★ SEM84602004E	R1.0	2.0	4	2	4	50	1.95
★ SEM84602006E	R1.0	2.0	4	2	6	50	1.95
★ SEM84602008E	R1.0	2.0	4	2	8	50	1.95
★ SEM84602010E	R1.0	2.0	4	2	10	50	1.95
★ SEM84602012E	R1.0	2.0	4	2	12	50	1.95
★ SEM84602014E	R1.0	2.0	4	2	14	50	1.95
★ SEM84602016E	R1.0	2.0	4	2	16	50	1.95
★ SEM84602018E	R1.0	2.0	4	2	18	50	1.95
★ SEM84602020E	R1.0	2.0	4	2	20	50	1.95

★ : Stock Item

▶ NEXT PAGE

Size	Radius Tolerance (mm)	Mill Dia. Tolerance (mm)	Shank Dia. Tolerance
up to R3	± 0.005	0 ~ - 0.012	h5
over R3	± 0.010	0 ~ - 0.015	

◎ : Excellent ○ : Good

ISO Material Description	P										M				K						
	Non-alloy steel					Low alloy steel					High alloyed steel, and tool steel		Stainless steel		Grey cast iron		Nodular cast iron		Malleable cast iron		
VDI 3323	1	2	3	4	5	6	7	8	9	10	11	12	13	14	15	16	17	18	19	20	
HRc	13	25	28	32	38	42	48	52	58	62	68	72	78	82	88	92	98	102	108	112	
HB	125	190	250	270	300	180	275	300	350	200	325	200	240	180	180	260	160	250	130	230	
Recommend	○	○	○	◎	◎	○	◎	◎	◎	◎	◎	○	○	○	○	○	○	○	○	○	○

CARBIDE, 2 FLUTE BALL NOSE with EXTENDED NECK

● **VOLLHARTMETALL, 2 SCHNEIDEN STIRNRADIUS mit LANG ABGESETZTEM SCHAFTTETEL**
 (●) **Fraise carbure, 2 dents, hémisphérique, détalonnée**
 (●) **MD, 2 TAGLIENTI, SEMISFERICA, SCARICATA**

▶ New coating and tool geometry applied resulting outstanding cutting abilities and wear resistance.
 ▶ With its unique ball nose geometry and cutting edges the cutting force has decreased, also increasing wear resistance.
 ▶ Excellent performance when cutting prehardened steels, up to HRC55 which are used for molds & dies.

▶ Aufgrund einer neuartigen Beschichtung und neuer Werkzeuggeometrien hervorragende Schnittleistung und Verschleißfestigkeit.
 ▶ Aufgrund der einzigartigen Kugelgeometrie und Schneidkantenpräparation wird die Schnittkraft reduziert und die Verschleißfestigkeit erhöht.
 ▶ Hervorragende Leistung bei der Zerspaltung von vorvergüteten Stählen bis HRC55, welche im Werkzeug- und Formenbau Verwendung finden.

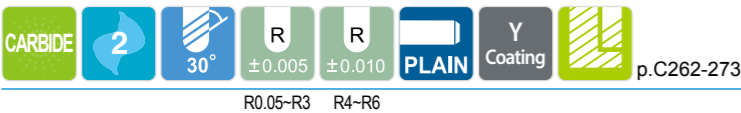
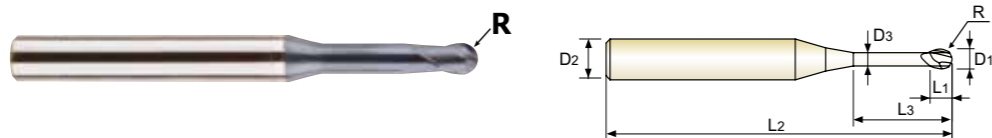

Flat Shank	Page	Plain Shank	Page
END MILL HOLDER	D118-137	HYDRAULIC CHUCK SHRINK FIT HOLDER	D15-46 D47-72
-	-	POWER MILLING CHUCK	D161-176
-	-	ER COLLET CHUCK SK SLIM CHUCK	D73-116 D183-201

R0.05-R3 R4-R6

Unit : mm

EDP No.	Radius of Ball Nose	Mill Diameter	Shank Diameter	Length of Cut	Length Below Shank	Overall Length	Neck Diameter
	R	D1	D2	L1	L3	L2	D3
SEM84602022E	R1.0	2.0	4	2	22	60	1.95
★ SEM84602026E	R1.0	2.0	4	2	26	60	1.95
★ SEM84602030E	R1.0	2.0	4	2	30	70	1.95
★ SEM84602035E	R1.0	2.0	4	2	35	70	1.95
SEM84602040E	R1.0	2.0	4	2	40	80	1.95
SEM84602045E	R1.0	2.0	4	2	45	90	1.95
SEM84602050E	R1.0	2.0	4	2	50	100	1.95
SEM84602060E	R1.0	2.0	4	2	60	110	1.95
★ SEM84602508E	R1.25	2.5	4	2.5	8	50	2.40
★ SEM84602510E	R1.25	2.5	4	2.5	10	50	2.40
★ SEM84602512E	R1.25	2.5	4	2.5	12	50	2.40
★ SEM84602516E	R1.25	2.5	4	2.5	16	50	2.40
★ SEM84602520E	R1.25	2.5	4	2.5	20	50	2.40
SEM84602522E	R1.25	2.5	4	2.5	22	60	2.40
SEM84602526E	R1.25	2.5	4	2.5	26	60	2.40
SEM84602530E	R1.25	2.5	4	2.5	30	70	2.40
SEM84602535E	R1.25	2.5	4	2.5	35	70	2.40
SEM84602540E	R1.25	2.5	4	2.5	40	80	2.40
SEM84602545E	R1.25	2.5	4	2.5	45	90	2.40
SEM84602550E	R1.25	2.5	4	2.5	50	100	2.40
★ SEM84603006E	R1.5	3.0	6	3	6	50	2.85
★ SEM84603008E	R1.5	3.0	6	3	8	50	2.85
★ SEM84603010E	R1.5	3.0	6	3	10	50	2.85
★ SEM84603012E	R1.5	3.0	6	3	12	50	2.85

★ : Stock Item

▶ NEXT PAGE

Size	Radius Tolerance (mm)	Mill Dia. Tolerance (mm)	Shank Dia. Tolerance
up to R3	± 0.005	0 ~ - 0.012	h5
over R3	± 0.010	0 ~ - 0.015	

◎ : Excellent ○ : Good

ISO Material Description	P										M					K					
	Non-alloy steel					Low alloy steel					High alloyed steel, and tool steel		Stainless steel			Grey cast iron		Nodular cast iron		Malleable cast iron	
VDI 3323	1	2	3	4	5	6	7	8	9	10	11	12	13	14	15	16	17	18	19	20	
HRc	13	25	28	32	38	40	45	50	55	60	65	70	75	80	85	90	95	100	105	110	
HB	125	190	250	270	300	180	275	300	350	200	325	200	240	180	180	260	160	250	130	230	
Recommend	○	○	○	◎	◎	◎	◎	◎	◎	◎	◎	◎	◎	◎	◎	◎	◎	◎	◎	◎	◎

CARBIDE, 2 FLUTE BALL NOSE with EXTENDED NECK

● **VOLLHARTMETALL, 2 SCHNEIDEN STIRNRADIUS mit LANG ABGESETZTEM SCHAFTTETEL**
 (●) **Fraise carbure, 2 dents, hémisphérique, détalonnée**
 (●) **MD, 2 TAGLIENTI, SEMISFERICA, SCARICATA**

▶ New coating and tool geometry applied resulting outstanding cutting abilities and wear resistance.
 ▶ With its unique ball nose geometry and cutting edges the cutting force has decreased, also increasing wear resistance.
 ▶ Excellent performance when cutting prehardened steels, up to HRC55 which are used for molds & dies.

▶ Aufgrund einer neuartigen Beschichtung und neuer Werkzeuggeometrien hervorragende Schnittleistung und Verschleißfestigkeit.
 ▶ Aufgrund der einzigartigen Kugelgeometrie und Schneidkantenpräparation wird die Schnittkraft reduziert und die Verschleißfestigkeit erhöht.
 ▶ Hervorragende Leistung bei der Zerspaltung von vorvergüteten Stählen bis HRC55, welche im Werkzeug- und Formenbau Verwendung finden.

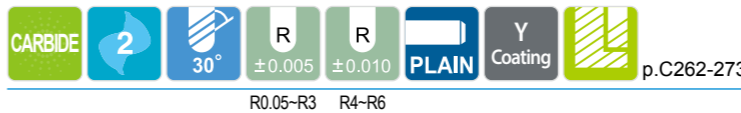
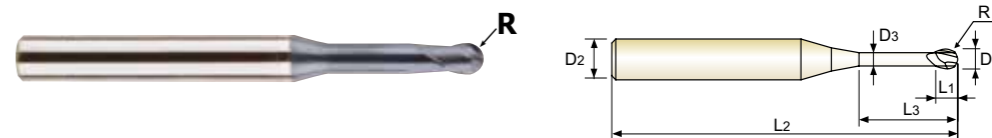

Flat Shank	Page	Plain Shank	Page
END MILL HOLDER	D118-137	HYDRAULIC CHUCK SHRINK FIT HOLDER	D15-46 D47-72
-	-	POWER MILLING CHUCK	D161-176
-	-	ER COLLET CHUCK SK SLIM CHUCK	D73-116 D183-201

R0.05-R3 R4-R6

Unit : mm

EDP No.	Radius of Ball Nose	Mill Diameter	Shank Diameter	Length of Cut	Length Below Shank	Overall Length	Neck Diameter
	R	D1	D2	L1	L3	L2	D3
★ SEM84603014E	R1.5	3.0	6	3	14	60	2.85
SEM84603015E	R1.5	3.0	6	3	15	60	2.85
★ SEM84603016E	R1.5	3.0	6	3	16	60	2.85
★ SEM84603018E	R1.5	3.0	6	3	18	60	2.85
★ SEM84603020E	R1.5	3.0	6	3	20	60	2.85
★ SEM84603022E	R1.5	3.0	6	3	22	65	2.85
★ SEM84603026E	R1.5	3.0	6	3	26	65	2.85
★ SEM84603030E	R1.5	3.0	6	3	30	70	2.85
★ SEM84603035E	R1.5	3.0	6	3	35	70	2.85
★ SEM84603040E	R1.5	3.0	6	3	40	80	2.85
★ SEM84603045E	R1.5	3.0	6	3	45	90	2.85
★ SEM84603050E	R1.5	3.0	6	3	50	100	2.85
SEM84603060E	R1.5	3.0	6	3	60	100	2.85
★ SEM84604008E	R2.0	4.0	6	4	8	50	3.85
★ SEM84604010E	R2.0	4.0	6	4	10	50	3.85
★ SEM84604012E	R2.0	4.0	6	4	12	50	3.85
★ SEM84604014E	R2.0	4.0	6	4	14	60	3.85
★ SEM84604016E	R2.0	4.0	6	4	16	60	3.85
★ SEM84604018E	R2.0	4.0	6	4	18	60	3.85
★ SEM84604020E	R2.0	4.0	6	4	20	60	3.85
★ SEM84604022E	R2.0	4.0	6	4	22	65	3.85
★ SEM84604026E	R2.0	4.0	6	4	26	65	3.85
★ SEM84604030E	R2.0	4.0	6	4	30	70	3.85
★ SEM84604035E	R2.0	4.0	6	4	35	70	3.85

★ : Stock Item

▶ NEXT PAGE

Size	Radius Tolerance (mm)	Mill Dia. Tolerance (mm)	Shank Dia. Tolerance
up to R3	± 0.005	0 ~ - 0.012	h5
over R3	± 0.010	0 ~ - 0.015	

◎ : Excellent ○ : Good

ISO Material Description	P										M					K					
	Non-alloy steel					Low alloy steel					High alloyed steel, and tool steel		Stainless steel			Grey cast iron		Nodular cast iron		Malleable cast iron	
VDI 3323	1	2	3	4	5	6	7	8	9	10	11	12	13	14	15	16	17	18	19	20	
HRc	13	25	28	32	38	40	45	50	55	60	65	70	75	80	85	90	95	100	105	110	
HB	125	190	250	270	300	180	275	300	350	200	325	200	240	180	180	260	160	250	130	230	
Recommend	○	○	○	◎	◎	◎	◎	◎	◎	◎	◎	◎	◎	◎	◎	◎	◎	◎	◎	◎	◎

CARBIDE, 2 FLUTE BALL NOSE with EXTENDED NECK

● VOLLHARTMETALL, 2 SCHNEIDEN STIRNRADIUS mit LANG ABGESETZTEM SCHAFTTETEL
 () Fraise carbure, 2 dents, hémisphérique, détalonnée
 () MD, 2 TAGLIENTI, SEMISFERICA, SCARICATA

- ▶ New coating and tool geometry applied resulting outstanding cutting abilities and wear resistance.
- ▶ With its unique ball nose geometry and cutting edges the cutting force has decreased, also increasing wear resistance.
- ▶ Excellent performance when cutting prehardened steels, up to HRc55 which are used for molds & dies.

- ▶ Aufgrund einer neuartigen Beschichtung und neuer Werkzeuggeometrien hervorragende Schnittleistung und Verschleißfestigkeit.
- ▶ Aufgrund der einzigartigen Kugelgeometrie und Schneidkantenpräparation wird die Schnittkraft reduziert und die Verschleißfestigkeit erhöht.
- ▶ Hervorragende Leistung bei der Zerspaltung von vorvergüteten Stählen bis HRc55, welche im Werkzeug- und Formenbau Verwendung finden.

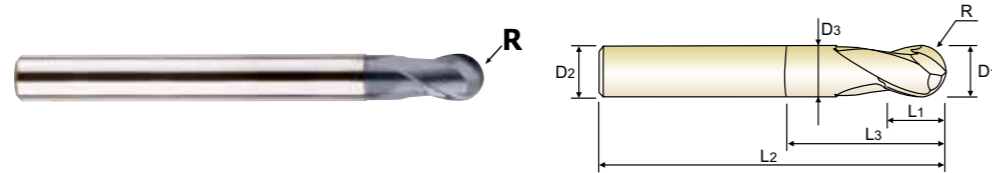

CARBIDE 2 30° R R PLAIN Coating Y p.C262-273 Recommended ToolHolder

Flat Shank	Page	Plain Shank	Page
END MILL HOLDER	D118-137	HYDRAULIC CHUCK SHRINK FIT HOLDER	D15-46 D47-72
-	-	POWER MILLING CHUCK	D161-176
-	-	ER COLLET CHUCK SK SLIM CHUCK	D73-116 D183-201

Unit : mm

EDP No.	Radius of Ball Nose	Mill Diameter	Shank Diameter	Length of Cut	Length Below Shank	Overall Length	Neck Diameter
	R	D1	D2	L1	L3	L2	D3
★ SEM84604040E	R2.0	4.0	6	4	40	80	3.85
SEM84604045E	R2.0	4.0	6	4	45	90	3.85
★ SEM84604050E	R2.0	4.0	6	4	50	100	3.85
SEM84604055E	R2.0	4.0	6	4	55	100	3.85
SEM84604060E	R2.0	4.0	6	4	60	100	3.85
SEM84605015E	R2.5	5.0	6	6	15	60	4.85
★ SEM84605020E	R2.5	5.0	6	6	20	60	4.85
★ SEM84605026E	R2.5	5.0	6	6	26	65	4.85
★ SEM84605030E	R2.5	5.0	6	6	30	70	4.85
★ SEM84605035E	R2.5	5.0	6	6	35	70	4.85
★ SEM84605040E	R2.5	5.0	6	6	40	80	4.85
SEM84605045E	R2.5	5.0	6	6	45	90	4.85
★ SEM84605050E	R2.5	5.0	6	6	50	100	4.85
SEM84605055E	R2.5	5.0	6	6	55	100	4.85
SEM84605060E	R2.5	5.0	6	6	60	100	4.85
★ SEM84606020E	R3.0	6.0	6	8	20	60	5.85
★ SEM84606030E	R3.0	6.0	6	8	30	60	5.85
★ SEM84606020090E	R3.0	6.0	6	12	20	90	5.85
★ SEM84606030090E	R3.0	6.0	6	12	30	90	5.85
★ SEM84608025E	R4.0	8.0	8	10	25	70	7.70
★ SEM84608035E	R4.0	8.0	8	10	35	70	7.70
SEM84608025100E	R4.0	8.0	8	14	25	100	7.70
★ SEM84608035100E	R4.0	8.0	8	14	35	100	7.70
★ SEM84610030E	R5.0	10.0	10	12	30	75	9.70

★ : Stock Item

Size	Radius Tolerance (mm)	Mill Dia. Tolerance (mm)	Shank Dia. Tolerance
up to R3	± 0.005	0 ~ - 0.012	h5
over R3	± 0.010	0 ~ - 0.015	

◎ : Excellent ○ : Good

ISO	P										M					K					
	Non-alloy steel					Low alloy steel					High alloyed steel, and tool steel		Stainless steel			Grey cast iron		Nodular cast iron			Malleable cast iron
Material Description	1	2	3	4	5	6	7	8	9	10	11	12	13	14	15	16	17	18	19	20	
VDI 3323	1	2	3	4	5	6	7	8	9	10	11	12	13	14	15	16	17	18	19	20	
HRc	13	25	28	32	30	29	32	38	35	35	15	23	10	10	26	3	25	21	21		
HB	125	190	250	270	300	180	275	300	350	200	325	200	240	180	180	260	160	250	130	230	
Recommend	○	○	○	◎	◎	◎	◎	◎	◎	◎	◎	○	○	○	○	○	○	○	○	○	○

CARBIDE, 2 FLUTE BALL NOSE with EXTENDED NECK

● VOLLHARTMETALL, 2 SCHNEIDEN STIRNRADIUS mit LANG ABGESETZTEM SCHAFTTETEL
 () Fraise carbure, 2 dents, hémisphérique, détalonnée
 () MD, 2 TAGLIENTI, SEMISFERICA, SCARICATA

- ▶ New coating and tool geometry applied resulting outstanding cutting abilities and wear resistance.
- ▶ With its unique ball nose geometry and cutting edges the cutting force has decreased, also increasing wear resistance.
- ▶ Excellent performance when cutting prehardened steels, up to HRc55 which are used for molds & dies.

- ▶ Aufgrund einer neuartigen Beschichtung und neuer Werkzeuggeometrien hervorragende Schnittleistung und Verschleißfestigkeit.
- ▶ Aufgrund der einzigartigen Kugelgeometrie und Schneidkantenpräparation wird die Schnittkraft reduziert und die Verschleißfestigkeit erhöht.
- ▶ Hervorragende Leistung bei der Zerspaltung von vorvergüteten Stählen bis HRc55, welche im Werkzeug- und Formenbau Verwendung finden.

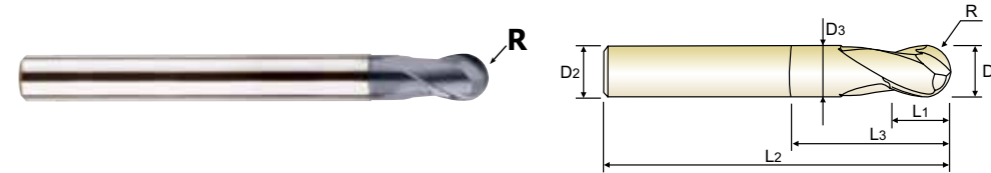

CARBIDE 2 30° R R PLAIN Coating Y p.C262-273 Recommended ToolHolder

Flat Shank	Page	Plain Shank	Page
END MILL HOLDER	D118-137	HYDRAULIC CHUCK SHRINK FIT HOLDER	D15-46 D47-72
-	-	POWER MILLING CHUCK	D161-176
-	-	ER COLLET CHUCK SK SLIM CHUCK	D73-116 D183-201

Unit : mm

EDP No.	Radius of Ball Nose	Mill Diameter	Shank Diameter	Length of Cut	Length Below Shank	Overall Length	Neck Diameter
	R	D1	D2	L1	L3	L2	D3
★ SEM84610040E	R5.0	10.0	10	12	40	75	9.70
★ SEM84610030100E	R5.0	10.0	10	18	30	100	9.70
★ SEM84610040100E	R5.0	10.0	10	18	40	100	9.70
★ SEM84612032E	R6.0	12.0	12	14	32	80	11.70
SEM84612045E	R6.0	12.0	12	14	45	80	11.70
★ SEM84612032110E	R6.0	12.0	12	22	32	110	11.70
★ SEM84612045110E	R6.0	12.0	12	22	45	110	11.70

★ : Stock Item

Size	Radius Tolerance (mm)	Mill Dia. Tolerance (mm)	Shank Dia. Tolerance
up to R3	± 0.005	0 ~ - 0.012	h5
over R3	± 0.010	0 ~ - 0.015	

◎ : Excellent ○ : Good

ISO	P										M					K					
	Non-alloy steel					Low alloy steel					High alloyed steel, and tool steel		Stainless steel			Grey cast iron		Nodular cast iron			Malleable cast iron
Material Description	1	2	3	4	5	6	7	8	9	10	11	12	13	14	15	16	17	18	19	20	
VDI 3323	1	2	3	4	5	6	7	8	9	10	11	12	13	14	15	16	17	18	19	20	
HRc	13	25	28	32	30	29	32	38	35	35	15	23	10	10	26	3	25	21	21		
HB	125	190	250	270	300	180	275	300	350	200	325	200	240	180	180	260	160	250	130	230	
Recommend	○	○	○	◎	◎	◎	◎	◎	◎	◎	◎	○	○	○	○	○	○	○	○	○	○

CARBIDE, 2 FLUTE BALL NOSE with EXTENDED NECK (6mm shank)

- VOLLHARTMETALL, 2 SCHNEIDEN STIRNRADIUS mit ABGESETZTEM SCHAFTTETL (6mm ZYLINDERSCHAFT)
Fraise carbure, 2 dents, hémisphérique, détalonnée (Ø queue 6mm)
MD, 2 TAGLIENTI, SEMISFERICA, SCARICATA (gambo 6mm)

New coating and tool geometry applied resulting outstanding cutting abilities and wear resistance.
With its unique ball nose geometry and cutting edges the cutting force has decreased, also increasing wear resistance.
Excellent performance when cutting prehardened steels, up to HRC55 which are used for molds & dies.

Aufgrund einer neuartigen Beschichtung und neuer Werkzeuggeometrien hervorragende Schnittleistung und Verschleißfestigkeit.
Aufgrund der einzigartigen Kugelgeometrie und Schneidkantenpräparation wird die Schnittkraft reduziert und die Verschleißfestigkeit erhöht.
Hervorragende Leistung bei der Zerspaltung von vorvergüteten Stählen bis HRC55, welche im Werkzeug- und Formenbau Verwendung finden.

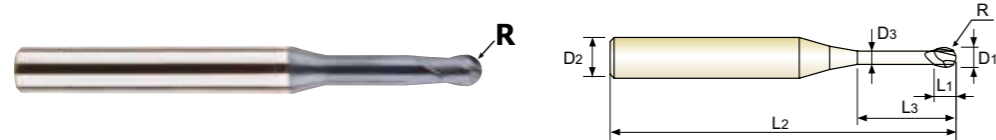

Product icons: CARBIDE, 2 flutes, 30 degree angle, R radius, PLAIN shank, Coating, Y chip formation, p.C262-273. Recommended Tool Holder table.

Table with 8 columns: EDP No., Radius of Ball Nose, Mill Diameter, Shank Diameter, Length of Cut, Length Below Shank, Overall Length, Neck Diameter. Lists various SEM846 series end mill models.

★ : Stock Item NEXT PAGE

Table with 3 columns: Radius Tolerance (mm), Mill Dia. Tolerance (mm), Shank Dia. Tolerance. Values: ± 0.005, 0 ~ - 0.012, h5.

◎ : Excellent ○ : Good

Material selection chart with columns for ISO, Material Description, and various material groups (P, M, K, N, S, H).

CARBIDE, 2 FLUTE BALL NOSE with EXTENDED NECK (6mm shank)

- VOLLHARTMETALL, 2 SCHNEIDEN STIRNRADIUS mit ABGESETZTEM SCHAFTTETL (6mm ZYLINDERSCHAFT)
Fraise carbure, 2 dents, hémisphérique, détalonnée (Ø queue 6mm)
MD, 2 TAGLIENTI, SEMISFERICA, SCARICATA (gambo 6mm)

New coating and tool geometry applied resulting outstanding cutting abilities and wear resistance.
With its unique ball nose geometry and cutting edges the cutting force has decreased, also increasing wear resistance.
Excellent performance when cutting prehardened steels, up to HRC55 which are used for molds & dies.

Aufgrund einer neuartigen Beschichtung und neuer Werkzeuggeometrien hervorragende Schnittleistung und Verschleißfestigkeit.
Aufgrund der einzigartigen Kugelgeometrie und Schneidkantenpräparation wird die Schnittkraft reduziert und die Verschleißfestigkeit erhöht.
Hervorragende Leistung bei der Zerspaltung von vorvergüteten Stählen bis HRC55, welche im Werkzeug- und Formenbau Verwendung finden.

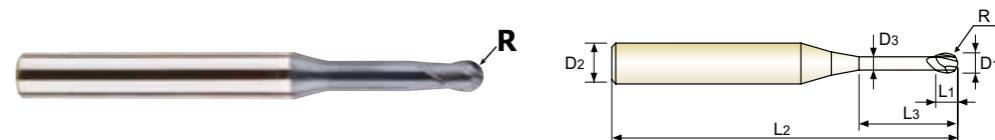

Product icons: CARBIDE, 2 flutes, 30 degree angle, R radius, PLAIN shank, Coating, Y chip formation, p.C262-273. Recommended Tool Holder table.

Table with 8 columns: EDP No., Radius of Ball Nose, Mill Diameter, Shank Diameter, Length of Cut, Length Below Shank, Overall Length, Neck Diameter. Lists various SEM846 series end mill models.

★ : Stock Item NEXT PAGE

Table with 3 columns: Radius Tolerance (mm), Mill Dia. Tolerance (mm), Shank Dia. Tolerance. Values: ± 0.005, 0 ~ - 0.012, h5.

◎ : Excellent ○ : Good

Material selection chart with columns for ISO, Material Description, and various material groups (P, M, K, N, S, H).

HSS

HSS



PLAIN SHANK SEM846 SERIES



PLAIN SHANK SEMD99 SERIES

CARBIDE, 2 FLUTE BALL NOSE with EXTENDED NECK (6mm shank)

● VOLLHARTMETALL, 2 SCHNEIDEN STIRNRADIUS mit ABGESETZTEM SCHAFTTETL (6mm ZYLINDERSCHAFT)
 () Fraise carbure, 2 dents, hémisphérique, détalonnée (Ø queue 6mm)
 () MD, 2 TAGLIENTI, SEMISFERICA, SCARICATA (gambo 6mm)

- ▶ New coating and tool geometry applied resulting outstanding cutting abilities and wear resistance.
- ▶ With its unique ball nose geometry and cutting edges the cutting force has decreased, also increasing wear resistance.
- ▶ Excellent performance when cutting prehardened steels, up to HRc55 which are used for molds & dies.

- ▶ Aufgrund einer neuartigen Beschichtung und neuer Werkzeuggeometrien hervorragende Schnittleistung und Verschleißfestigkeit.
- ▶ Aufgrund der einzigartigen Kugelgeometrie und Schneidkantenpräparation wird die Schnittkraft reduziert und die Verschleißfestigkeit erhöht.
- ▶ Hervorragende Leistung bei der Zerspaltung von vorvergüteten Stählen bis HRc55, welche im Werkzeug- und Formenbau Verwendung finden.

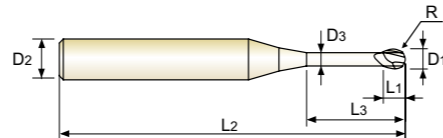

CARBIDE 2 30° ±0.005 PLAIN Coating Y p.C262-273

Flat Shank	Page	Plain Shank	Page
END MILL HOLDER	D118-137	HYDRAULIC CHUCK SHRINK FIT HOLDER	D15-46 D47-72
-	-	POWER MILLING CHUCK	D161-176
-	-	ER COLLET CHUCK SK SLIM CHUCK	D73-116 D183-201

Unit : mm

EDP No.	Radius of Ball Nose	Mill Diameter	Shank Diameter	Length of Cut	Length Below Shank	Overall Length	Neck Diameter
	R	D1	D2	L1	L3	L2	D3
★ SEM846015126SE	R0.75	1.5	6	1.5	12	50	1.45
SEM846015146SE	R0.75	1.5	6	1.5	14	50	1.45
SEM846015166SE	R0.75	1.5	6	1.5	16	50	1.45
SEM846015186SE	R0.75	1.5	6	1.5	18	50	1.45
SEM846015206SE	R0.75	1.5	6	1.5	20	50	1.45
SEM846015226SE	R0.75	1.5	6	1.5	22	60	1.45
SEM846015266SE	R0.75	1.5	6	1.5	26	60	1.45
SEM846015306SE	R0.75	1.5	6	1.5	30	70	1.45
SEM846015356SE	R0.75	1.5	6	1.5	35	70	1.45
SEM846015406SE	R0.75	1.5	6	1.5	40	80	1.45
SEM846020046SE	R1.0	2.0	6	2	4	50	1.95
★ SEM846020066SE	R1.0	2.0	6	2	6	50	1.95
★ SEM846020086SE	R1.0	2.0	6	2	8	50	1.95
★ SEM846020106SE	R1.0	2.0	6	2	10	50	1.95
★ SEM846020126SE	R1.0	2.0	6	2	12	50	1.95
SEM846020146SE	R1.0	2.0	6	2	14	50	1.95
★ SEM846020166SE	R1.0	2.0	6	2	16	50	1.95
SEM846020186SE	R1.0	2.0	6	2	18	50	1.95
★ SEM846020206SE	R1.0	2.0	6	2	20	50	1.95
SEM846020226SE	R1.0	2.0	6	2	22	60	1.95
SEM846020266SE	R1.0	2.0	6	2	26	60	1.95
SEM846020306SE	R1.0	2.0	6	2	30	70	1.95
SEM846020356SE	R1.0	2.0	6	2	35	70	1.95
SEM846020406SE	R1.0	2.0	6	2	40	80	1.95
SEM846020456SE	R1.0	2.0	6	2	45	90	1.95
SEM846020506SE	R1.0	2.0	6	2	50	100	1.95

★ : Stock Item

Radius Tolerance (mm)	Mill Dia. Tolerance (mm)	Shank Dia. Tolerance
± 0.005	0 ~ - 0.012	h5

◎ : Excellent ○ : Good

ISO Material Description	P										M						K					
	Non-alloy steel					Low alloy steel					High alloyed steel, and tool steel		Stainless steel				Grey cast iron		Nodular cast iron		Malleable cast iron	
VDI 3323	1	2	3	4	5	6	7	8	9	10	11	12	13	14	15	16	17	18	19	20		
HRc	13	25	28	32	35	38	42	48	52	58	62	68	72	78	82	88	92	98	102	108		
HB	125	190	250	270	300	180	275	300	350	200	325	200	240	180	180	260	160	250	130	230		
Recommend	○	○	◎	◎	◎	◎	◎	◎	◎	◎	◎	◎	◎	◎	◎	◎	◎	◎	◎	◎		

CARBIDE, 2 FLUTE CORNER RADIUS (Short, Regular, Long Shank)

● VOLLHARTMETALL, 2 SCHNEIDEN ECKENRADIUS
 () Fraise carbure, 2 dents, torique
 () MD, 2 TAGLIENTI, TORICA (Serie corta, media e lunga)

- ▶ New coating and tool geometry applied resulting outstanding cutting abilities and wear resistance.
- ▶ Excellent for cutting prehardened steels, carbon steels, alloy steels of molds and dies, up to HRc55 and machine parts.
- ▶ Available in short, regular and long shank end mills.
- ▶ Available with various corner radius end mills, from 0.02mm to 5.0mm corner radius.

- ▶ Aufgrund einer neuartigen Beschichtung und neuer Werkzeuggeometrien hervorragende Schnittleistung und Verschleißfestigkeit
- ▶ Ausgezeichnet geeignet für das Fräsen von vorvergütetem Stahl, kohlenstoff Stahl, legiertem Stahl für Formen, bis HRc55 und Maschinenbauteile.
- ▶ Erhältlich in den Schaft-Ausführungen: kurz, standard und lang
- ▶ Erhältlich in verschiedenen Eckradien-Ausführungen: von 0,02mm bis zu 5,0mm Eckradius.

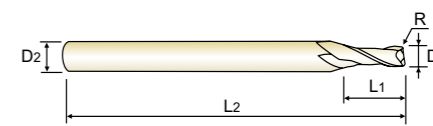

CARBIDE 2 30° ±0.010 ±0.015 PLAIN Coating Y p.C274-275

Flat Shank	Page	Plain Shank	Page
END MILL HOLDER	D118-137	HYDRAULIC CHUCK SHRINK FIT HOLDER	D15-46 D47-72
-	-	POWER MILLING CHUCK	D161-176
-	-	ER COLLET CHUCK SK SLIM CHUCK	D73-116 D183-201

00.2-06 07-020 Unit : mm

EDP No.	Corner Radius	Mill Diameter	Shank Diameter	Length of Cut	Overall Length	Remark
	R	D1	D2	L1	L2	
SEMD99002002E	R0.02	0.2	4	0.4	40	-
SEMD99002005E	R0.05	0.2	4	0.4	40	-
SEMD99003002E	R0.02	0.3	4	0.6	40	-
SEMD99003005E	R0.05	0.3	4	0.6	40	-
SEMD99004005E	R0.05	0.4	4	0.8	40	-
SEMD9900401E	R0.1	0.4	4	0.8	40	-
SEMD99005005E	R0.05	0.5	4	1	40	-
SEMD9900501E	R0.1	0.5	4	1	40	-
SEMD99006005E	R0.05	0.6	4	1.2	40	-
SEMD9900601E	R0.1	0.6	4	1.2	40	-
SEMD9900602E	R0.2	0.6	4	1.2	40	-
SEMD99007005E	R0.05	0.7	4	1.4	40	-
SEMD9900701E	R0.1	0.7	4	1.4	40	-
SEMD9900702E	R0.2	0.7	4	1.4	40	-
SEMD99008005E	R0.05	0.8	4	1.6	40	-
SEMD9900801E	R0.1	0.8	4	1.6	40	-
SEMD9900802E	R0.2	0.8	4	1.6	40	-
SEMD99009005E	R0.05	0.9	4	1.8	40	-
SEMD9900901E	R0.1	0.9	4	1.8	40	-
SEMD990100054SE	R0.05	1.0	4	2.5	50	4mm Shank
SEMD99010014SE	R0.1	1.0	4	2.5	50	4mm Shank
SEMD99010024SE	R0.2	1.0	4	2.5	50	4mm Shank
SEMD99010034SE	R0.3	1.0	4	2.5	50	4mm Shank
SEMD99010005E	R0.05	1.0	6	2.5	50	-

★ : Stock Item

Size	Corner Radius Tolerance (mm)	Mill Dia. Tolerance (mm)	Shank Dia. Tolerance
up to Ø6	± 0.010	0 ~ - 0.012	h5
over Ø6	± 0.015	0 ~ - 0.015	

◎ : Excellent ○ : Good

ISO Material Description	P										M						K					
	Non-alloy steel					Low alloy steel					High alloyed steel, and tool steel		Stainless steel				Grey cast iron		Nodular cast iron		Malleable cast iron	
VDI 3323	1	2	3	4	5	6	7	8	9	10	11	12	13	14	15	16	17	18	19	20		
HRc	13	25	28	32	35	38	42	48	52	58	62	68	72	78	82	88	92	98	102	108		
HB	125	190	250	270	300	180	275	300	350	200	325	200	240	180	180	260	160	250	130	230		
Recommend	○	○	◎	◎	◎	◎	◎	◎	◎	◎	◎	◎	◎	◎	◎	◎	◎	◎	◎	◎		



PLAIN SHANK SEMD99 SERIES

CARBIDE, 2 FLUTE CORNER RADIUS (Short, Regular, Long Shank)

- VOLLHARTMETALL, 2 SCHNEIDEN ECKENRADIUS
- () Fraise carbure, 2 dents, torique
- () MD, 2 TAGLIENTI, TORICA (Serie corta, media e lunga)

▶ New coating and tool geometry applied resulting outstanding cutting abilities and wear resistance.
 ▶ Excellent for cutting prehardened steels, carbon steels, alloy steels of molds and dies, up to HRC55 and machine parts.
 ▶ Available in short, regular and long shank end mills.
 ▶ Available with various corner radius end mills, from 0.02mm to 5.0mm corner radius.

▶ Aufgrund einer neuartigen Beschichtung und neuer Werkzeuggeometrien hervorragende Schnittleistung und Verschleißfestigkeit
 ▶ Ausgezeichnet geeignet für das Fräsen von vorvergütetem Stahl, kohlenstoff Stahl, legiertem Stahl für Formen, bis HRC55 und Maschinenbauteile.
 ▶ Erhältlich in den Schaft-Ausführungen: kurz, standard und lang
 ▶ Erhältlich in verschiedenen Eckradien-Ausführungen: von 0,02mm bis zu 5,0mm Eckradius.

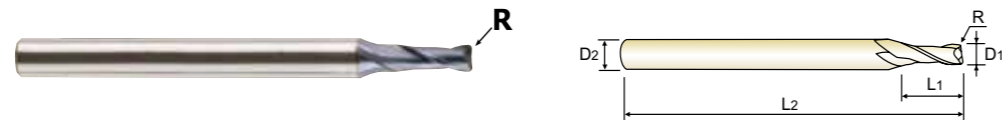

Flat Shank	Page	Plain Shank	Page
END MILL HOLDER	D118-137	HYDRAULIC CHUCK SHRINK FIT HOLDER	D15-46 D47-72
-	-	POWER MILLING CHUCK	D161-176
-	-	ER COLLET CHUCK SK SLIM CHUCK	D73-116 D183-201



00.2-06 07-020

Unit : mm

EDP No.	Corner Radius	Mill Diameter	Shank Diameter	Length of Cut	Overall Length	Remark
	R	D1	D2	L1	L2	
SEMD9901001E	R0.1	1.0	6	2.5	50	-
★ SEMD9901002E	R0.2	1.0	6	2.5	50	-
★ SEMD9901003E	R0.3	1.0	6	2.5	50	-
SEMD990120054SE	R0.05	1.2	4	3	50	4mm Shank
SEMD99012014SE	R0.1	1.2	4	3	50	4mm Shank
SEMD99012024SE	R0.2	1.2	4	3	50	4mm Shank
SEMD99012034SE	R0.3	1.2	4	3	50	4mm Shank
SEMD99012005E	R0.05	1.2	6	3	50	-
SEMD9901201E	R0.1	1.2	6	3	50	-
SEMD9901202E	R0.2	1.2	6	3	50	-
SEMD9901203E	R0.3	1.2	6	3	50	-
SEMD990150054SE	R0.05	1.5	4	4	50	-
SEMD99015014SE	R0.1	1.5	4	4	50	4mm Shank
SEMD99015024SE	R0.2	1.5	4	4	50	4mm Shank
SEMD99015034SE	R0.3	1.5	4	4	50	4mm Shank
SEMD99015054SE	R0.5	1.5	4	4	50	4mm Shank
SEMD99015005E	R0.05	1.5	6	4	50	-
SEMD9901501E	R0.1	1.5	6	4	50	-
★ SEMD9901502E	R0.2	1.5	6	4	50	-
★ SEMD9901503E	R0.3	1.5	6	4	50	-
★ SEMD9901505E	R0.5	1.5	6	4	50	-
SEMD99020014SE	R0.1	2.0	4	6	50	4mm Shank
SEMD99020024SE	R0.2	2.0	4	6	50	4mm Shank
SEMD99020034SE	R0.3	2.0	4	6	50	4mm Shank

★ : Stock Item

▶ NEXT PAGE

Size	Corner Radius Tolerance (mm)	Mill Dia. Tolerance (mm)	Shank Dia. Tolerance
up to Ø6	± 0.010	0 ~ - 0.012	h5
over Ø6	± 0.015	0 ~ - 0.015	

◎ : Excellent ○ : Good

ISO Material Description	P										M						K					
	Non-alloy steel					Low alloy steel					High alloyed steel, and tool steel		Stainless steel				Grey cast iron		Nodular cast iron		Malleable cast iron	
VDI 3323	1	2	3	4	5	6	7	8	9	10	11	12	13	14	15	16	17	18	19	20		
HRc	13	25	28	32	30	29	32	38	35	35	15	23	10	10	26	3	25	21	21			
HB	125	190	250	270	300	180	275	300	350	200	325	200	240	180	180	260	160	250	130	230		
Recommend	○	○	◎	◎	◎	○	◎	◎	◎	◎	◎	○	○	○	○	○	○	○	○	○	○	



PLAIN SHANK SEMD99 SERIES

CARBIDE, 2 FLUTE CORNER RADIUS (Short, Regular, Long Shank)

- VOLLHARTMETALL, 2 SCHNEIDEN ECKENRADIUS
- () Fraise carbure, 2 dents, torique
- () MD, 2 TAGLIENTI, TORICA (Serie corta, media e lunga)

▶ New coating and tool geometry applied resulting outstanding cutting abilities and wear resistance.
 ▶ Excellent for cutting prehardened steels, carbon steels, alloy steels of molds and dies, up to HRC55 and machine parts.
 ▶ Available in short, regular and long shank end mills.
 ▶ Available with various corner radius end mills, from 0.02mm to 5.0mm corner radius.

▶ Aufgrund einer neuartigen Beschichtung und neuer Werkzeuggeometrien hervorragende Schnittleistung und Verschleißfestigkeit
 ▶ Ausgezeichnet geeignet für das Fräsen von vorvergütetem Stahl, kohlenstoff Stahl, legiertem Stahl für Formen, bis HRC55 und Maschinenbauteile.
 ▶ Erhältlich in den Schaft-Ausführungen: kurz, standard und lang
 ▶ Erhältlich in verschiedenen Eckradien-Ausführungen: von 0,02mm bis zu 5,0mm Eckradius.

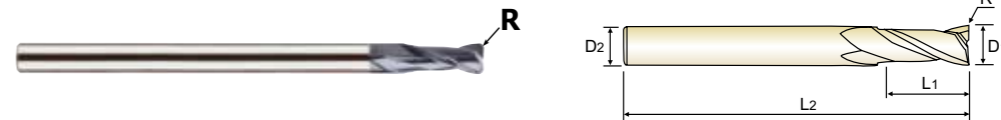

Flat Shank	Page	Plain Shank	Page
END MILL HOLDER	D118-137	HYDRAULIC CHUCK SHRINK FIT HOLDER	D15-46 D47-72
-	-	POWER MILLING CHUCK	D161-176
-	-	ER COLLET CHUCK SK SLIM CHUCK	D73-116 D183-201



00.2-06 07-020

Unit : mm

EDP No.	Corner Radius	Mill Diameter	Shank Diameter	Length of Cut	Overall Length	Remark
	R	D1	D2	L1	L2	
SEMD99020054SE	R0.5	2.0	4	6	50	4mm Shank
SEMD9902001E	R0.1	2.0	6	6	50	-
★ SEMD9902002E	R0.2	2.0	6	6	50	-
★ SEMD9902003E	R0.3	2.0	6	6	50	-
★ SEMD9902005E	R0.5	2.0	6	6	50	-
SEMD99025014SE	R0.1	2.5	4	7	60	4mm Shank
SEMD99025024SE	R0.2	2.5	4	7	60	4mm Shank
SEMD99025034SE	R0.3	2.5	4	7	60	4mm Shank
SEMD99025054SE	R0.5	2.5	4	7	60	4mm Shank
SEMD9902501E	R0.1	2.5	6	7	60	-
SEMD9902502E	R0.2	2.5	6	7	60	-
SEMD9902503E	R0.3	2.5	6	7	60	-
SEMD9902505E	R0.5	2.5	6	7	60	-
SEMD9903001E	R0.1	3.0	6	8	60	-
★ SEMD9903002E	R0.2	3.0	6	8	60	-
★ SEMD9903003E	R0.3	3.0	6	8	60	-
★ SEMD9903005E	R0.5	3.0	6	8	60	-
SEMD9903010E	R1.0	3.0	6	8	60	-
SEMD9903501E	R0.1	3.5	6	10	70	-
SEMD9903502E	R0.2	3.5	6	10	70	-
SEMD9903503E	R0.3	3.5	6	10	70	-
SEMD9903505E	R0.5	3.5	6	10	70	-
SEMD99040014SE	R0.1	4.0	4	10	70	4mm Shank
SEMD99040024SE	R0.2	4.0	4	10	70	4mm Shank

★ : Stock Item

▶ NEXT PAGE

Size	Corner Radius Tolerance (mm)	Mill Dia. Tolerance (mm)	Shank Dia. Tolerance
up to Ø6	± 0.010	0 ~ - 0.012	h5
over Ø6	± 0.015	0 ~ - 0.015	

◎ : Excellent ○ : Good

ISO Material Description	P										M						K					
	Non-alloy steel					Low alloy steel					High alloyed steel, and tool steel		Stainless steel				Grey cast iron		Nodular cast iron		Malleable cast iron	
VDI 3323	1	2	3	4	5	6	7	8	9	10	11	12	13	14	15	16	17	18	19	20		
HRc	13	25	28	32	30	29	32	38	35	35	15	23	10	10	26	3	25	21	21			
HB	125	190	250	270	300	180	275	300	350	200	325	200	240	180	180	260	160	250	130	230		
Recommend	○	○	◎	◎	◎	○	◎	◎	◎	◎	◎	○	○	○	○	○	○	○	○	○	○	

CARBIDE, 2 FLUTE CORNER RADIUS (Short, Regular, Long Shank)

VOLLHARTMETALL, 2 SCHNEIDEN ECKENRADIUS
 (Fraise carbure, 2 dents, torique)
 (MD, 2 TAGLIENTI, TORICA (Serie corta, media e lunga))

- ▶ New coating and tool geometry applied resulting outstanding cutting abilities and wear resistance.
- ▶ Excellent for cutting prehardened steels, carbon steels, alloy steels of molds and dies, up to HRC55 and machine parts.
- ▶ Available in short, regular and long shank end mills.
- ▶ Available with various corner radius end mills, from 0.02mm to 5.0mm corner radius.

- ▶ Aufgrund einer neuartigen Beschichtung und neuer Werkzeuggeometrien hervorragende Schnittleistung und Verschleißfestigkeit
- ▶ Ausgezeichnet geeignet für das Fräsen von vorvergütetem Stahl, kohlenstoff Stahl, legiertem Stahl für Formen, bis HRC55 und Maschinenbauteile.
- ▶ Erhältlich in den Schaft-Ausführungen: kurz, standard und lang
- ▶ Erhältlich in verschiedenen Eckradien-Ausführungen: von 0,02mm bis zu 5,0mm Eckradius.



CARBIDE 2 30° ±0.010 ±0.015 PLAIN Coating Y p.C274-275

Flat Shank	Page	Plain Shank	Page
END MILL HOLDER	D118-137	HYDRAULIC CHUCK SHRINK FIT HOLDER	D15-46 D47-72
-	-	POWER MILLING CHUCK	D161-176
-	-	ER COLLET CHUCK SK SLIM CHUCK	D73-116 D183-201

EDP No.	Corner Radius	Mill Diameter	Shank Diameter	Length of Cut	Overall Length	Remark
	R	D1	D2	L1	L2	
SEMD99040034SE	R0.3	4.0	4	10	70	4mm Shank
SEMD99040054SE	R0.5	4.0	4	10	70	4mm Shank
SEMD99040104SE	R1.0	4.0	4	10	70	4mm Shank
SEMD99040011004SE	R0.1	4.0	4	10	100	4mm Shank
SEMD99040021004SE	R0.2	4.0	4	10	100	4mm Shank
SEMD99040031004SE	R0.3	4.0	4	10	100	4mm Shank
SEMD99040051004SE	R0.5	4.0	4	10	100	4mm Shank
SEMD99040101004SE	R1.0	4.0	4	10	100	4mm Shank
SEMD9904001E	R0.1	4.0	6	10	70	Regular
★ SEMD9904002E	R0.2	4.0	6	10	70	Regular
★ SEMD9904003E	R0.3	4.0	6	10	70	Regular
★ SEMD9904005E	R0.5	4.0	6	10	70	Regular
★ SEMD9904010E	R1.0	4.0	6	10	70	Regular
SEMD9904501E	R0.1	4.5	6	11	80	-
SEMD9904502E	R0.2	4.5	6	11	80	-
SEMD9904503E	R0.3	4.5	6	11	80	-
SEMD9904505E	R0.5	4.5	6	11	80	-
SEMD9905001E	R0.1	5.0	6	13	90	-
★ SEMD9905002E	R0.2	5.0	6	13	90	-
★ SEMD9905003E	R0.3	5.0	6	13	90	-
★ SEMD9905005E	R0.5	5.0	6	13	90	-
★ SEMD9905010E	R1.0	5.0	6	13	90	-
SEMD9905501E	R0.1	5.5	6	13	90	-
SEMD9905502E	R0.2	5.5	6	13	90	-

★ : Stock Item ▶ NEXT PAGE

Size	Corner Radius Tolerance (mm)	Mill Dia. Tolerance (mm)	Shank Dia. Tolerance
up to Ø6	± 0.010	0 ~ - 0.012	h5
over Ø6	± 0.015	0 ~ - 0.015	

◎ : Excellent ○ : Good

ISO Material Description	P										M						K					
	Non-alloy steel					Low alloy steel					High alloyed steel, and tool steel		Stainless steel				Grey cast iron		Nodular cast iron		Malleable cast iron	
VDI 3323	1	2	3	4	5	6	7	8	9	10	11	12	13	14	15	16	17	18	19	20		
HRc	13	25	28	32	32	10	29	32	38	15	35	15	23	10	10	26	3	25	21	21		
HB	125	190	250	270	300	180	275	300	350	200	325	200	240	180	180	260	160	250	130	230		
Recommend	○	○	◎	◎	◎	○	◎	◎	◎	◎	◎	○	○	○	○	○	○	○	○	○	○	

ISO Material Description	N										S						H						
	Aluminum-wrought alloy		Aluminum-cast, alloyed				Copper and Copper Alloys (Bronze / Brass)				Non Metallic Materials		Heat Resistant Super Alloys				Titanium Alloys		Hardened steel		Chilled Cast Iron		Hardened Cast Iron
VDI 3323	21	22	23	24	25	26	27	28	29	30	31	32	33	34	35	36	37	38	39	40	41		
HRc	21	22	23	24	25	26	27	28	29	30	31	32	33	34	35	36	37	38	39	40	41		
HB	60	100	75	90	130	110	90	100			200	280	250	350	320	400 Rm	1050 Rm	550	630	400	550		
Recommend																		○	◎	◎	○		

CARBIDE, 2 FLUTE CORNER RADIUS (Short, Regular, Long Shank)

VOLLHARTMETALL, 2 SCHNEIDEN ECKENRADIUS
 (Fraise carbure, 2 dents, torique)
 (MD, 2 TAGLIENTI, TORICA (Serie corta, media e lunga))

- ▶ New coating and tool geometry applied resulting outstanding cutting abilities and wear resistance.
- ▶ Excellent for cutting prehardened steels, carbon steels, alloy steels of molds and dies, up to HRC55 and machine parts.
- ▶ Available in short, regular and long shank end mills.
- ▶ Available with various corner radius end mills, from 0.02mm to 5.0mm corner radius.

- ▶ Aufgrund einer neuartigen Beschichtung und neuer Werkzeuggeometrien hervorragende Schnittleistung und Verschleißfestigkeit
- ▶ Ausgezeichnet geeignet für das Fräsen von vorvergütetem Stahl, kohlenstoff Stahl, legiertem Stahl für Formen, bis HRC55 und Maschinenbauteile.
- ▶ Erhältlich in den Schaft-Ausführungen: kurz, standard und lang
- ▶ Erhältlich in verschiedenen Eckradien-Ausführungen: von 0,02mm bis zu 5,0mm Eckradius.

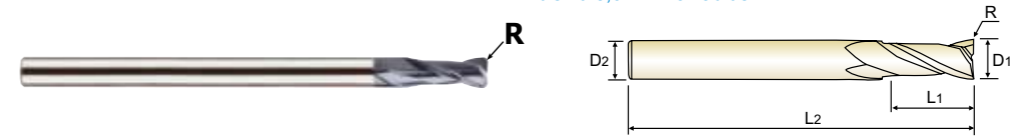

CARBIDE 2 30° ±0.010 ±0.015 PLAIN Coating Y p.C274-275

Flat Shank	Page	Plain Shank	Page
END MILL HOLDER	D118-137	HYDRAULIC CHUCK SHRINK FIT HOLDER	D15-46 D47-72
-	-	POWER MILLING CHUCK	D161-176
-	-	ER COLLET CHUCK SK SLIM CHUCK	D73-116 D183-201

EDP No.	Corner Radius	Mill Diameter	Shank Diameter	Length of Cut	Overall Length	Remark
	R	D1	D2	L1	L2	
SEMD9905503E	R0.3	5.5	6	13	90	-
SEMD9905505E	R0.5	5.5	6	13	90	-
SEMD9905510E	R1.0	5.5	6	13	90	-
★ SEMD9906002060E	R0.2	6.0	6	15	60	Short
★ SEMD9906003060E	R0.3	6.0	6	15	60	Short
★ SEMD9906005060E	R0.5	6.0	6	15	60	Short
★ SEMD9906010060E	R1.0	6.0	6	15	60	Short
SEMD9906001E	R0.1	6.0	6	15	90	Regular
★ SEMD9906002E	R0.2	6.0	6	15	90	Regular
★ SEMD9906003E	R0.3	6.0	6	15	90	Regular
★ SEMD9906005E	R0.5	6.0	6	15	90	Regular
★ SEMD9906010E	R1.0	6.0	6	15	90	Regular
SEMD9906015E	R1.5	6.0	6	15	90	Regular
SEMD9906020E	R2.0	6.0	6	15	90	Regular
SEMD9906005110E	R0.5	6.0	6	15	110	Long Shank
SEMD9906010110E	R1.0	6.0	6	15	110	Long Shank
SEMD9906005130E	R0.5	6.0	6	15	130	Long Shank
SEMD9906010130E	R1.0	6.0	6	15	130	Long Shank
SEMD9907001E	R0.1	7.0	8	16	90	-
SEMD9907002E	R0.2	7.0	8	16	90	-
SEMD9907003E	R0.3	7.0	8	16	90	-
SEMD9907005E	R0.5	7.0	8	16	90	-
SEMD9907010E	R1.0	7.0	8	16	90	-
SEMD9907020E	R2.0	7.0	8	16	90	-

★ : Stock Item ▶ NEXT PAGE

Size	Corner Radius Tolerance (mm)	Mill Dia. Tolerance (mm)	Shank Dia. Tolerance
up to Ø6	± 0.010	0 ~ - 0.012	h5
over Ø6	± 0.015	0 ~ - 0.015	

◎ : Excellent ○ : Good

ISO Material Description	P										M						K					
	Non-alloy steel					Low alloy steel					High alloyed steel, and tool steel		Stainless steel				Grey cast iron		Nodular cast iron		Malleable cast iron	
VDI 3323	1	2	3	4	5	6	7	8	9	10	11	12	13	14	15	16	17	18	19	20		
HRc	13	25	28	32	32	10	29	32	38	15	35	15	23	10	10	26	3	25	21	21		
HB	125	190	250	270	300	180	275	300	350	200	325	200	240	180	180	260	160	250	130	230		
Recommend	○	○	◎	◎	◎	○	◎	◎	◎	◎	◎	○	○	○	○	○	○	○	○	○	○	

ISO Material Description	N										S						H						
	Aluminum-wrought alloy		Aluminum-cast, alloyed				Copper and Copper Alloys (Bronze / Brass)				Non Metallic Materials		Heat Resistant Super Alloys				Titanium Alloys		Hardened steel		Chilled Cast Iron		Hardened Cast Iron
VDI 3323	21	22	23	24	25	26	27	28	29	30	31	32	33	34	35	36	37	38	39	40	41		
HRc	21	22	23	24	25	26	27	28	29	30	31	32	33	34	35	36	37	38	39	40	41		
HB	60	100	75	90	130	110	90	100			200	280	250	350	320	400 Rm	1050 Rm	550	630	400	550		
Recommend																		○	◎	◎	○		



PLAIN SHANK SEMD99 SERIES

CARBIDE, 2 FLUTE CORNER RADIUS (Short, Regular, Long Shank)

- VOLLHARTMETALL, 2 SCHNEIDEN ECKENRADIUS
- ① Fraise carbure, 2 dents, torique
- ② MD, 2 TAGLIENTI, TORICA (Serie corta, media e lunga)

▶ New coating and tool geometry applied resulting outstanding cutting abilities and wear resistance.
 ▶ Excellent for cutting prehardened steels, carbon steels, alloy steels of molds and dies, up to HRC55 and machine parts.
 ▶ Available in short, regular and long shank end mills.
 ▶ Available with various corner radius end mills, from 0.02mm to 5.0mm corner radius.

▶ Aufgrund einer neuartigen Beschichtung und neuer Werkzeuggeometrien hervorragende Schnittleistung und Verschleißfestigkeit
 ▶ Ausgezeichnet geeignet für das Fräsen von vorvergütetem Stahl, kohlenstoff Stahl, legiertem Stahl für Formen, bis HRC55 und Maschinenbauteile.
 ▶ Erhältlich in den Schaft-Ausführungen: kurz, standard und lang
 ▶ Erhältlich in verschiedenen Eckradien-Ausführungen: von 0,02mm bis zu 5,0mm Eckradius.

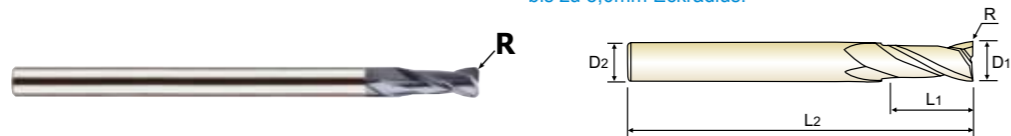

Icons: CARBIDE, 2, 30°, ±0.010, ±0.015, PLAIN, Coating, Y, p.C274-275

Flat Shank	Page	Plain Shank	Page
END MILL HOLDER	D118-137	HYDRAULIC CHUCK SHRINK FIT HOLDER	D15-46 D47-72
-	-	POWER MILLING CHUCK	D161-176
-	-	ER COLLET CHUCK SK SLIM CHUCK	D73-116 D183-201

EDP No.	Corner Radius	Mill Diameter	Shank Diameter	Length of Cut	Overall Length	Remark
	R	D1	D2	L1	L2	
SEMD9908003070E	R0.3	8.0	8	20	70	Short
★ SEMD9908005070E	R0.5	8.0	8	20	70	Short
★ SEMD9908010070E	R1.0	8.0	8	20	70	Short
SEMD9908001E	R0.1	8.0	8	20	100	Regular
SEMD9908002E	R0.2	8.0	8	20	100	Regular
SEMD9908003E	R0.3	8.0	8	20	100	Regular
★ SEMD9908005E	R0.5	8.0	8	20	100	Regular
★ SEMD9908010E	R1.0	8.0	8	20	100	Regular
★ SEMD9908015E	R1.5	8.0	8	20	100	Regular
★ SEMD9908020E	R2.0	8.0	8	20	100	Regular
SEMD9908025E	R2.5	8.0	8	20	100	Regular
SEMD9908030E	R3.0	8.0	8	20	100	Regular
SEMD9908005120E	R0.5	8.0	8	20	120	Long Shank
SEMD9908010120E	R1.0	8.0	8	20	120	Long Shank
SEMD9908015150E	R0.5	8.0	8	20	150	Long Shank
SEMD9908010150E	R1.0	8.0	8	20	150	Long Shank
SEMD9910003075E	R0.3	10.0	10	25	75	Short
★ SEMD9910005075E	R0.5	10.0	10	25	75	Short
★ SEMD9910010075E	R1.0	10.0	10	25	75	Short
SEMD9910001E	R0.1	10.0	10	25	100	Regular
SEMD9910002E	R0.2	10.0	10	25	100	Regular
SEMD9910003E	R0.3	10.0	10	25	100	Regular
★ SEMD9910005E	R0.5	10.0	10	25	100	Regular
★ SEMD9910010E	R1.0	10.0	10	25	100	Regular

★ : Stock Item ▶ NEXT PAGE

Size	Corner Radius Tolerance (mm)	Mill Dia. Tolerance (mm)	Shank Dia. Tolerance
up to Ø6	± 0.010	0 ~ - 0.012	h5
over Ø6	± 0.015	0 ~ - 0.015	

◎ : Excellent ○ : Good

ISO Material Description	P										M						K					
	Non-alloy steel					Low alloy steel					High alloyed steel, and tool steel		Stainless steel				Grey cast iron		Nodular cast iron		Malleable cast iron	
VDI 3323	1	2	3	4	5	6	7	8	9	10	11	12	13	14	15	16	17	18	19	20		
HRc	13	25	28	32	30	29	32	38	35	35	15	23	10	10	26	3	25	21	21			
HB	125	190	250	270	300	180	275	300	350	200	325	200	240	180	180	260	160	250	130	230		
Recommend	○	○	◎	◎	◎	○	◎	◎	◎	◎	◎	○	○	○	○	○	○	○	○	○	○	



PLAIN SHANK SEMD99 SERIES

CARBIDE, 2 FLUTE CORNER RADIUS (Short, Regular, Long Shank)

- VOLLHARTMETALL, 2 SCHNEIDEN ECKENRADIUS
- ① Fraise carbure, 2 dents, torique
- ② MD, 2 TAGLIENTI, TORICA (Serie corta, media e lunga)

▶ New coating and tool geometry applied resulting outstanding cutting abilities and wear resistance.
 ▶ Excellent for cutting prehardened steels, carbon steels, alloy steels of molds and dies, up to HRC55 and machine parts.
 ▶ Available in short, regular and long shank end mills.
 ▶ Available with various corner radius end mills, from 0.02mm to 5.0mm corner radius.

▶ Aufgrund einer neuartigen Beschichtung und neuer Werkzeuggeometrien hervorragende Schnittleistung und Verschleißfestigkeit
 ▶ Ausgezeichnet geeignet für das Fräsen von vorvergütetem Stahl, kohlenstoff Stahl, legiertem Stahl für Formen, bis HRC55 und Maschinenbauteile.
 ▶ Erhältlich in den Schaft-Ausführungen: kurz, standard und lang
 ▶ Erhältlich in verschiedenen Eckradien-Ausführungen: von 0,02mm bis zu 5,0mm Eckradius.



Icons: CARBIDE, 2, 30°, ±0.010, ±0.015, PLAIN, Coating, Y, p.C274-275

Flat Shank	Page	Plain Shank	Page
END MILL HOLDER	D118-137	HYDRAULIC CHUCK SHRINK FIT HOLDER	D15-46 D47-72
-	-	POWER MILLING CHUCK	D161-176
-	-	ER COLLET CHUCK SK SLIM CHUCK	D73-116 D183-201

EDP No.	Corner Radius	Mill Diameter	Shank Diameter	Length of Cut	Overall Length	Remark
	R	D1	D2	L1	L2	
★ SEMD9910015E	R1.5	10.0	10	25	100	Regular
★ SEMD9910020E	R2.0	10.0	10	25	100	Regular
SEMD9910025E	R2.5	10.0	10	25	100	Regular
SEMD9910030E	R3.0	10.0	10	25	100	Regular
SEMD9910040E	R4.0	10.0	10	25	100	Regular
SEMD9910005130E	R0.5	10.0	10	25	130	Long Shank
SEMD9910010130E	R1.0	10.0	10	25	130	Long Shank
SEMD9910005150E	R0.5	10.0	10	25	150	Long Shank
SEMD9910010150E	R1.0	10.0	10	25	150	Long Shank
SEMD9911002E	R0.2	11.0	12	25	110	-
SEMD9911003E	R0.3	11.0	12	25	110	-
SEMD9911005E	R0.5	11.0	12	25	110	-
SEMD9911010E	R1.0	11.0	12	25	110	-
SEMD9911020E	R2.0	11.0	12	25	110	-
SEMD9912003080E	R0.3	12.0	12	30	80	Short
★ SEMD9912005080E	R0.5	12.0	12	30	80	Short
★ SEMD9912010080E	R1.0	12.0	12	30	80	Short
SEMD9912001E	R0.1	12.0	12	30	110	Regular
SEMD9912002E	R0.2	12.0	12	30	110	Regular
SEMD9912003E	R0.3	12.0	12	30	110	Regular
★ SEMD9912005E	R0.5	12.0	12	30	110	Regular
★ SEMD9912010E	R1.0	12.0	12	30	110	Regular
★ SEMD9912015E	R1.5	12.0	12	30	110	Regular
★ SEMD9912020E	R2.0	12.0	12	30	110	Regular

★ : Stock Item ▶ NEXT PAGE

Size	Corner Radius Tolerance (mm)	Mill Dia. Tolerance (mm)	Shank Dia. Tolerance
up to Ø6	± 0.010	0 ~ - 0.012	h5
over Ø6	± 0.015	0 ~ - 0.015	

◎ : Excellent ○ : Good

ISO Material Description	P										M						K					
	Non-alloy steel					Low alloy steel					High alloyed steel, and tool steel		Stainless steel				Grey cast iron		Nodular cast iron		Malleable cast iron	
VDI 3323	1	2	3	4	5	6	7	8	9	10	11	12	13	14	15	16	17	18	19	20		
HRc	13	25	28	32	30	29	32	38	35	35	15	23	10	10	26	3	25	21	21			
HB	125	190	250	270	300	180	275	300	350	200	325	200	240	180	180	260	160	250	130	230		
Recommend	○	○	◎	◎	◎	○	◎	◎	◎	◎	◎	○	○	○	○	○	○	○	○	○	○	

CARBIDE, 2 FLUTE CORNER RADIUS (Short, Regular, Long Shank)

- **VOLLHARTMETALL, 2 SCHNEIDEN ECKENRADIUS**
- ① **Fraise carbure, 2 dents, torique**
- ② **MD, 2 TAGLIENTI, TORICA (Serie corta, media e lunga)**

- ▶ New coating and tool geometry applied resulting outstanding cutting abilities and wear resistance.
- ▶ Excellent for cutting prehardened steels, carbon steels, alloy steels of molds and dies, up to HRC55 and machine parts.
- ▶ Available in short, regular and long shank end mills.
- ▶ Available with various corner radius end mills, from 0.02mm to 5.0mm corner radius.

- ▶ Aufgrund einer neuartigen Beschichtung und neuer Werkzeuggeometrien hervorragende Schnittleistung und Verschleißfestigkeit
- ▶ Ausgezeichnet geeignet für das Fräsen von vorvergütetem Stahl, kohlenstoff Stahl, legiertem Stahl für Formen, bis HRC55 und Maschinenbauteile.
- ▶ Erhältlich in den Schaft-Ausführungen: kurz, standard und lang
- ▶ Erhältlich in verschiedenen Eckradien-Ausführungen: von 0,02mm bis zu 5,0mm Eckradius.

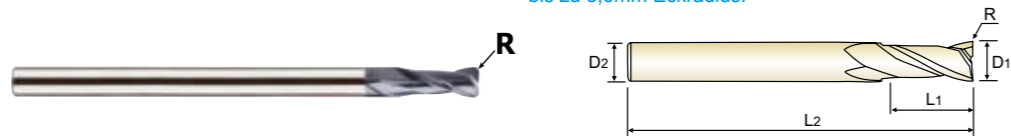

CARBIDE 2 30° ±0.010 ±0.015 **PLAIN** Coating Y p.C274-275

Flat Shank	Page	Plain Shank	Page
END MILL HOLDER	D118-137	HYDRAULIC CHUCK SHRINK FIT HOLDER	D15-46 D47-72
-	-	POWER MILLING CHUCK	D161-176
-	-	ER COLLET CHUCK SK SLIM CHUCK	D73-116 D183-201

00.2-06 07-020

Unit : mm

EDP No.	Corner Radius	Mill Diameter	Shank Diameter	Length of Cut	Overall Length	Remark
	R	D1	D2	L1	L2	
★ SEMD9912025E	R2.5	12.0	12	30	110	Regular
★ SEMD9912030E	R3.0	12.0	12	30	110	Regular
SEMD9912040E	R4.0	12.0	12	30	110	Regular
SEMD9912050E	R5.0	12.0	12	30	110	Regular
SEMD9912005130E	R0.5	12.0	12	30	130	Long Shank
SEMD9912010130E	R1.0	12.0	12	30	130	Long Shank
SEMD9912005150E	R0.5	12.0	12	30	150	Long Shank
SEMD9912010150E	R1.0	12.0	12	30	150	Long Shank
SEMD9914005E	R0.5	14.0	16	35	150	-
★ SEMD9914010E	R1.0	14.0	16	35	150	-
SEMD9914020E	R2.0	14.0	16	35	150	-
SEMD9916005E	R0.5	16.0	16	32	150	-
★ SEMD9916010E	R1.0	16.0	16	32	150	-
SEMD9916015E	R1.5	16.0	16	32	150	-
★ SEMD9916020E	R2.0	16.0	16	32	150	-
SEMD9920005E	R0.5	20.0	20	38	150	-
★ SEMD9920010E	R1.0	20.0	20	38	150	-
SEMD9920015E	R1.5	20.0	20	38	150	-
★ SEMD9920020E	R2.0	20.0	20	38	150	-

★ : Stock Item

Size	Corner Radius Tolerance (mm)	Mill Dia. Tolerance (mm)	Shank Dia. Tolerance
up to Ø6	± 0.010	0 ~ - 0.012	h5
over Ø6	± 0.015	0 ~ - 0.015	

◎ : Excellent ○ : Good

ISO Material Description	P										M						K				
	Non-alloy steel					Low alloy steel					High alloyed steel, and tool steel		Stainless steel				Grey cast iron		Nodular cast iron		Malleable cast iron
VDI 3323	1	2	3	4	5	6	7	8	9	10	11	12	13	14	15	16	17	18	19	20	
HRc	13	25	28	32	30	29	32	38	35	15	35	15	23	10	10	26	3	25	21	21	
HB	125	190	250	270	300	180	275	300	350	200	325	200	240	180	180	260	160	250	130	230	
Recommend	○	○	◎	◎	◎	○	◎	◎	◎	◎	◎	○	○	○	○	○	○	○	○	○	○

ISO Material Description	N										S						H				
	Aluminum-wrought alloy		Aluminum-cast, alloyed			Copper and Copper Alloys (Bronze / Brass)					Non Metallic Materials		Heat Resistant Super Alloys				Titanium Alloys		Hardened steel	Chilled Cast Iron	Hardened Cast Iron
VDI 3323	21	22	23	24	25	26	27	28	29	30	31	32	33	34	35	36	37	38	39	40	41
HRc	21	22	23	24	25	26	27	28	29	30	31	32	33	34	35	36	37	38	39	40	41
HB	60	100	75	90	130	110	90	100			200	280	250	350	320	400 Rm	1050 Rm	550	630	400	550
Recommend																		○	◎		○

CARBIDE, 2 FLUTE CORNER RADIUS with EXTENDED NECK

- **VOLLHARTMETALL, 2 SCHNEIDEN ECKENRADIUS mit ABGESETZTEM SCHAFTTETEL**
- ① **Fraise carbure, 2 dents, torique, détalonnée**
- ② **MD, 2 TAGLIENTI, SCARICATA, TORICA**

- ▶ Due to new coating and new tool geometry, outstanding cutting ability and wear resistance.
- ▶ Excellent for cutting prehardened steels, carbon steels, alloy steels of molds and dies, up to HRC55 and machine parts.
- ▶ Available various products like regular length and long shank end mills etc.
- ▶ Available various corner radius end mills, from min. 0.02mm corner radius to max. 2.0mm corner radius.
- ▶ Available more various effective length and overall length end mills than previous standard products.

- ▶ Aufgrund einer neuartigen Beschichtung und neuer Werkzeuggeometrien hervorragende Schnittleistung und Verschleißfestigkeit
- ▶ Ausgezeichnet geeignet für das Fräsen von vorvergütetem Stahl, kohlenstoff Stahl, legiertem Stahl für Formen, bis HRC55 und Maschinenbauteile.
- ▶ Erhältlich in den Schaft-Ausführungen: standard und lang.
- ▶ Erhältlich in verschiedenen Eckradien-Ausführungen: von 0,02mm bis zu 2,0mm Eckradius.
- ▶ Erhältlich in verschiedenen gesamt Längen und effektiv Längen. Mehr Auswahlmöglichkeiten als bei den bisherigen standard Produkten.

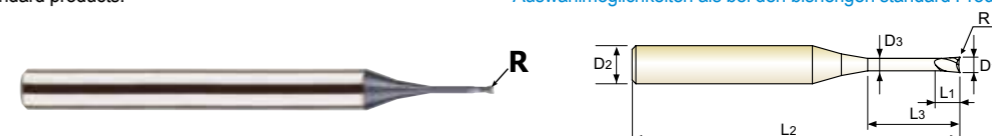

CARBIDE 2 30° ±0.010 ±0.015 **PLAIN** Coating Y p.C276-283

Flat Shank	Page	Plain Shank	Page
END MILL HOLDER	D118-137	HYDRAULIC CHUCK SHRINK FIT HOLDER	D15-46 D47-72
-	-	POWER MILLING CHUCK	D161-176
-	-	ER COLLET CHUCK SK SLIM CHUCK	D73-116 D183-201

00.2-06 07-020

Unit : mm

EDP No.	Corner Radius	Mill Diameter	Shank Diameter	Length of Cut	Length Below Shank	Overall Length	Neck Diameter	Remark
	R	D1	D2	L1	L3	L2	D3	
SEME61002002005E	R0.02	0.2	4	0.3	0.5	40	0.17	-
★ SEME6100200201E	R0.02	0.2	4	0.3	1	40	0.17	-
SEME61002002015E	R0.02	0.2	4	0.3	1.5	40	0.17	-
SEME6100200202E	R0.02	0.2	4	0.3	2	40	0.17	-
SEME61002005005E	R0.05	0.2	4	0.3	0.5	40	0.17	-
★ SEME6100200501E	R0.05	0.2	4	0.3	1	40	0.17	-
SEME61002005015E	R0.05	0.2	4	0.3	1.5	40	0.17	-
SEME6100200502E	R0.05	0.2	4	0.3	2	40	0.17	-
SEME61003005015SE	R0.05	0.3	4	0.25	1.5	40	0.27	-
★ SEME6100300201E	R0.02	0.3	4	0.5	1	40	0.27	-
★ SEME6100300202E	R0.02	0.3	4	0.5	2	40	0.27	-
SEME6100300203E	R0.02	0.3	4	0.5	3	40	0.27	-
★ SEME6100300501E	R0.05	0.3	4	0.5	1	40	0.27	-
★ SEME6100300502E	R0.05	0.3	4	0.5	2	40	0.27	-
SEME6100300503E	R0.05	0.3	4	0.5	3	40	0.27	-
SEME6100300502S6SE	R0.05	0.3	6	0.25	2	40	0.27	-
★ SEME6100400501E	R0.05	0.4	4	0.6	1	40	0.37	-
★ SEME61004005015E	R0.05	0.4	4	0.6	1.5	40	0.37	-
★ SEME6100400502E	R0.05	0.4	4	0.6	2	40	0.37	-
★ SEME61004005025E	R0.05	0.4	4	0.6	2.5	40	0.37	-
SEME6100400503E	R0.05	0.4	4	0.6	3	40	0.37	-
SEME6100400504E	R0.05	0.4	4	0.6	4	40	0.37	-
★ SEME610040101E	R0.1	0.4	4	0.6	1	40	0.37	-
SEME6100401015E	R0.1	0.4	4	0.6	1.5	40	0.37	-

★ : Stock Item

▶ NEXT PAGE

Size	Corner Radius Tolerance (mm)	Mill Dia. Tolerance (mm)	Shank Dia. Tolerance
up to Ø6	± 0.010	0 ~ - 0.012	h5
over Ø6	± 0.015	0 ~ - 0.015	

◎ : Excellent ○ : Good

ISO Material Description	P										M						K				
	Non-alloy steel					Low alloy steel					High alloyed steel, and tool steel		Stainless steel				Grey cast iron		Nodular cast iron		Malleable cast iron
VDI 3323	1	2	3	4	5	6	7	8	9	10	11	12	13	14	15	16	17	18	19	20	
HRc	13	25	28	32	30	29	32	38	35	15	35	15	23	10	10	26	3	25	21	21	
HB	125	190	250	270	300	180	275	300	350	200	325	200	240	180	180	260	160	250	130	230	
Recommend	○	○	◎	◎	◎	○	◎	◎	◎	◎	◎	○	○	○	○	○	○	○	○	○	○

ISO Material Description	N										S						H				
	Aluminum-wrought alloy		Aluminum-cast, alloyed			Copper and Copper Alloys (Bronze / Brass)					Non Metallic Materials		Heat Resistant Super Alloys				Titanium Alloys		Hardened steel	Chilled Cast Iron	Hardened Cast Iron
VDI 3323	21	22	23	24	25	26	27	28	29	30	31	32	33	34	35	36	37	38	39	40	41
HRc	21	22	23	24	25	26	27	28	29	30	31	32	33	34	35	36	37	38	39	40	41
HB	60	100	75	90	130	110	90	100			200	280	250	350	320	400 Rm	1050 Rm	550	630	400	550
Recommend																		○	◎		○

CARBIDE, 2 FLUTE CORNER RADIUS with EXTENDED NECK

- VOLLHARTMETALL, 2 SCHNEIDEN ECKENRADIUS mit ABGESETZTEM SCHAFTTETEL
- () Fraise carbure, 2 dents, torique, détalonnée
- () MD, 2 TAGLIENTI, SCARICATA, TORICA

- ▶ Due to new coating and new tool geometry, outstanding cutting ability and wear resistance.
- ▶ Excellent for cutting prehardened steels, carbon steels, alloy steels of molds and dies, up to HRC55 and machine parts.
- ▶ Available various products like regular length and long shank end mills etc.
- ▶ Available various corner radius end mills, from min. 0.02mm corner radius to max. 2.0mm corner radius.
- ▶ Available more various effective length and overall length end mills than previous standard products.

- ▶ Aufgrund einer neuartigen Beschichtung und neuer Werkzeuggeometrien hervorragende Schnittleistung und Verschleißfestigkeit
- ▶ Ausgezeichnet geeignet für das Fräsen von vorvergütetem Stahl, kohlenstoff Stahl, legiertem Stahl für Formen, bis HRC55 und Maschinenbauteile.
- ▶ Erhältlich in den Schaft-Ausführungen: standard und lang.
- ▶ Erhältlich in verschiedenen Eckradien-Ausführungen: von 0,02mm bis zu 2,0mm Eckradius.
- ▶ Erhältlich in verschiedenen gesamt Längen und effektiv Längen. Mehr Auswahlmöglichkeiten als bei den bisherigen standard Produkten.

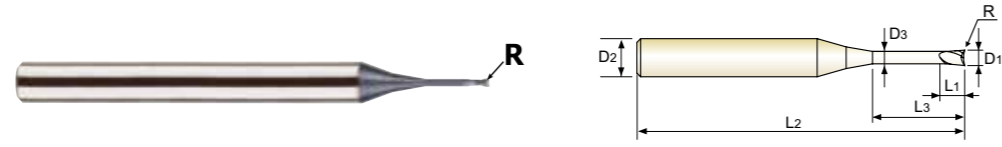

CARBIDE
2
30°
±0.010
±0.015
PLAIN
Coating
Y
p.C276-283

Flat Shank	Page	Plain Shank	Page
END MILL HOLDER	D118-137	HYDRAULIC CHUCK SHRINK FIT HOLDER	D15-46 D47-72
-	-	POWER MILLING CHUCK	D161-176
-	-	ER COLLET CHUCK SK SLIM CHUCK	D73-116 D183-201

EDP No.	Corner Radius	Mill Diameter	Shank Diameter	Length of Cut	Length Below Shank	Overall Length	Neck Diameter	Remark
	R	D1	D2	L1	L3	L2	D3	
★ SEME610040102E	R0.1	0.4	4	0.6	2	40	0.37	-
SEME6100401025E	R0.1	0.4	4	0.6	2.5	40	0.37	-
SEME610040103E	R0.1	0.4	4	0.6	3	40	0.37	-
SEME610040104E	R0.1	0.4	4	0.6	4	40	0.37	-
★ SEME6100500501E	R0.05	0.5	4	0.7	1	45	0.45	-
★ SEME61005005015E	R0.05	0.5	4	0.7	1.5	45	0.45	-
★ SEME6100500502E	R0.05	0.5	4	0.7	2	45	0.45	-
SEME61005005025E	R0.05	0.5	4	0.7	2.5	45	0.45	-
SEME6100500503E	R0.05	0.5	4	0.7	3	45	0.45	-
★ SEME6100500504E	R0.05	0.5	4	0.7	4	45	0.45	-
SEME6100500505E	R0.05	0.5	4	0.7	5	45	0.45	-
SEME6100500506E	R0.05	0.5	4	0.7	6	45	0.45	-
SEME6100500504S6SE	R0.05	0.5	6	0.4	4	45	0.45	-
SEME610050101E	R0.1	0.5	4	0.7	1	45	0.45	-
SEME6100501015E	R0.1	0.5	4	0.7	1.5	45	0.45	-
★ SEME610050102E	R0.1	0.5	4	0.7	2	45	0.45	-
SEME6100501025E	R0.1	0.5	4	0.7	2.5	45	0.45	-
★ SEME610050103E	R0.1	0.5	4	0.7	3	45	0.45	-
SEME610050104E	R0.1	0.5	4	0.7	4	45	0.45	-
★ SEME610050105E	R0.1	0.5	4	0.7	5	45	0.45	-
SEME610050106E	R0.1	0.5	4	0.7	6	45	0.45	-
SEME610050102S6SE	R0.1	0.5	6	0.4	2	45	0.45	-
SEME610050104S6SE	R0.1	0.5	6	0.4	4	45	0.45	-
SEME6100600502E	R0.05	0.6	4	0.9	2	45	0.55	-

★ : Stock Item ▶ NEXT PAGE

Size	Corner Radius Tolerance (mm)	Mill Dia. Tolerance (mm)	Shank Dia. Tolerance
up to Ø6	± 0.010	0 ~ - 0.012	h5
over Ø6	± 0.015	0 ~ - 0.015	

◎ : Excellent ○ : Good

ISO Material Description	P										M						K				
	Non-alloy steel					Low alloy steel					High alloyed steel, and tool steel		Stainless steel				Grey cast iron		Nodular cast iron	Malleable cast iron	
VDI 3323	1	2	3	4	5	6	7	8	9	10	11	12	13	14	15	16	17	18	19	20	
HRc	13	25	28	32	32	10	29	32	38	15	35	15	23	10	10	26	3	25	21	21	
HB	125	190	250	270	300	180	275	300	350	200	325	200	240	180	180	260	160	250	130	230	
Recommend	○	○	◎	◎	◎	○	◎	◎	◎	◎	◎	○	○	○	○	○	○	○	○	○	○

ISO Material Description	N										S						H					
	Aluminum-wrought alloy		Aluminum-cast, alloyed		Copper and Copper Alloys (Bronze / Brass)						Non Metallic Materials		Heat Resistant Super Alloys						Titanium Alloys		Hardened steel	Chilled Cast Iron
VDI 3323	21	22	23	24	25	26	27	28	29	30	31	32	33	34	35	36	37	38	39	40	41	
HRc	15	30	25	38	34						15	30	25	38	34			55	60	42	55	
HB	60	100	75	90	130	110	90	100			200	280	250	350	320	400 Rm	1050 Rm	550	630	400	550	
Recommend																		○	◎	○	○	

CARBIDE, 2 FLUTE CORNER RADIUS with EXTENDED NECK

- VOLLHARTMETALL, 2 SCHNEIDEN ECKENRADIUS mit ABGESETZTEM SCHAFTTETEL
- () Fraise carbure, 2 dents, torique, détalonnée
- () MD, 2 TAGLIENTI, SCARICATA, TORICA

- ▶ Due to new coating and new tool geometry, outstanding cutting ability and wear resistance.
- ▶ Excellent for cutting prehardened steels, carbon steels, alloy steels of molds and dies, up to HRC55 and machine parts.
- ▶ Available various products like regular length and long shank end mills etc.
- ▶ Available various corner radius end mills, from min. 0.02mm corner radius to max. 2.0mm corner radius.
- ▶ Available more various effective length and overall length end mills than previous standard products.

- ▶ Aufgrund einer neuartigen Beschichtung und neuer Werkzeuggeometrien hervorragende Schnittleistung und Verschleißfestigkeit
- ▶ Ausgezeichnet geeignet für das Fräsen von vorvergütetem Stahl, kohlenstoff Stahl, legiertem Stahl für Formen, bis HRC55 und Maschinenbauteile.
- ▶ Erhältlich in den Schaft-Ausführungen: standard und lang.
- ▶ Erhältlich in verschiedenen Eckradien-Ausführungen: von 0,02mm bis zu 2,0mm Eckradius.
- ▶ Erhältlich in verschiedenen gesamt Längen und effektiv Längen. Mehr Auswahlmöglichkeiten als bei den bisherigen standard Produkten.

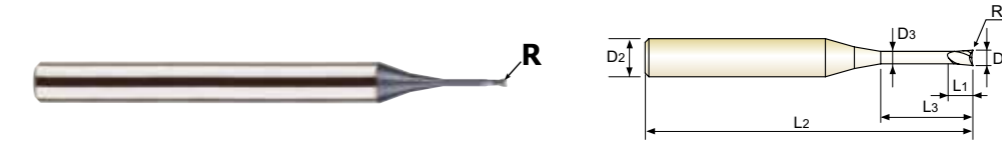

CARBIDE
2
30°
±0.010
±0.015
PLAIN
Coating
Y
p.C276-283

Flat Shank	Page	Plain Shank	Page
END MILL HOLDER	D118-137	HYDRAULIC CHUCK SHRINK FIT HOLDER	D15-46 D47-72
-	-	POWER MILLING CHUCK	D161-176
-	-	ER COLLET CHUCK SK SLIM CHUCK	D73-116 D183-201

EDP No.	Corner Radius	Mill Diameter	Shank Diameter	Length of Cut	Length Below Shank	Overall Length	Neck Diameter	Remark
	R	D1	D2	L1	L3	L2	D3	
★ SEME6100600503E	R0.05	0.6	4	0.9	3	45	0.55	-
SEME6100600504E	R0.05	0.6	4	0.9	4	45	0.55	-
★ SEME6100600506E	R0.05	0.6	4	0.9	6	45	0.55	-
SEME6100600508E	R0.05	0.6	4	0.9	8	45	0.55	-
SEME6100600510E	R0.05	0.6	4	0.9	10	45	0.55	-
★ SEME610060102E	R0.1	0.6	4	0.9	2	45	0.55	-
★ SEME610060103E	R0.1	0.6	4	0.9	3	45	0.55	-
★ SEME610060104E	R0.1	0.6	4	0.9	4	45	0.55	-
★ SEME610060106E	R0.1	0.6	4	0.9	6	45	0.55	-
SEME610060108E	R0.1	0.6	4	0.9	8	45	0.55	-
SEME610060110E	R0.1	0.6	4	0.9	10	45	0.55	-
★ SEME610060202E	R0.2	0.6	4	0.9	2	45	0.55	-
★ SEME610060203E	R0.2	0.6	4	0.9	3	45	0.55	-
★ SEME610060204E	R0.2	0.6	4	0.9	4	45	0.55	-
★ SEME610060206E	R0.2	0.6	4	0.9	6	45	0.55	-
SEME610060208E	R0.2	0.6	4	0.9	8	45	0.55	-
SEME610060210E	R0.2	0.6	4	0.9	10	45	0.55	-
SEME6100700502E	R0.05	0.7	4	1.2	2	45	0.65	-
SEME6100700504E	R0.05	0.7	4	1.2	4	45	0.65	-
SEME6100700506E	R0.05	0.7	4	1.2	6	45	0.65	-
SEME6100700508E	R0.05	0.7	4	1.2	8	45	0.65	-
SEME6100700510E	R0.05	0.7	4	1.2	10	45	0.65	-
SEME610070102E	R0.1	0.7	4	1.2	2	45	0.65	-
SEME610070104E	R0.1	0.7	4	1.2	4	45	0.65	-

★ : Stock Item ▶ NEXT PAGE

Size	Corner Radius Tolerance (mm)	Mill Dia. Tolerance (mm)	Shank Dia. Tolerance
up to Ø6	± 0.010	0 ~ - 0.012	h5
over Ø6	± 0.015	0 ~ - 0.015	

◎ : Excellent ○ : Good

ISO Material Description	P										M						K				
	Non-alloy steel					Low alloy steel					High alloyed steel, and tool steel		Stainless steel				Grey cast iron		Nodular cast iron	Malleable cast iron	
VDI 3323	1	2	3	4	5	6	7	8	9	10	11	12	13	14	15	16	17	18	19	20	
HRc	13	25	28	32	32	10	29	32	38	15	35	15	23	10	10	26	3	25	21	21	
HB	125	190	250	270	300	180	275	300	350	200	325	200	240	180	180	260	160	250	130	230	
Recommend	○	○	◎	◎	◎	○	◎	◎	◎	◎	◎	○	○	○	○	○	○	○	○	○	○

ISO Material Description	N										S						H					
	Aluminum-wrought alloy		Aluminum-cast, alloyed		Copper and Copper Alloys (Bronze / Brass)						Non Metallic Materials		Heat Resistant Super Alloys						Titanium Alloys		Hardened steel	Chilled Cast Iron
VDI 3323	21	22	23	24	25	26	27	28	29	30	31	32	33	34	35	36	37	38	39	40	41	
HRc	15	30	25	38	34						15	30	25	38	34			55	60	42	55	
HB	60	100	75	90	130	110	90	100			200	280	250	350	320	400 Rm	1050 Rm	550	630	400	550	
Recommend																		○	◎	○	○	



PLAIN SHANK SEME61 SERIES

CARBIDE, 2 FLUTE CORNER RADIUS with EXTENDED NECK

● VOLLHARTMETALL, 2 SCHNEIDEN ECKENRADIUS mit ABGESETZTEM SCHAFTTETL
 (●) Fraise carbure, 2 dents, torique, détalonnée
 (●) MD, 2 TAGLIENTI, SCARICATA, TORICA

- ▶ Due to new coating and new tool geometry, outstanding cutting ability and wear resistance.
- ▶ Excellent for cutting prehardened steels, carbon steels, alloy steels of molds and dies, up to HRC55 and machine parts.
- ▶ Available various products like regular length and long shank end mills etc.
- ▶ Available various corner radius end mills, from min. 0.02mm corner radius to max. 2.0mm corner radius.
- ▶ Available more various effective length and overall length end mills than previous standard products.

- ▶ Aufgrund einer neuartigen Beschichtung und neuer Werkzeuggeometrien hervorragende Schnittleistung und Verschleißfestigkeit
- ▶ Ausgezeichnet geeignet für das Fräsen von vorvergrütem Stahl, kohlenstoff Stahl, legiertem Stahl für Formen, bis HRC55 und Maschinenbauteile.
- ▶ Erhältlich in den Schaft-Ausführungen: standard und lang.
- ▶ Erhältlich in verschiedenen Eckradien-Ausführungen: von 0,02mm bis zu 2,0mm Eckradius.
- ▶ Erhältlich in verschiedenen gesamt Längen und effektiv Längen. Mehr Auswahlmöglichkeiten als bei den bisherigen standard Produkten.

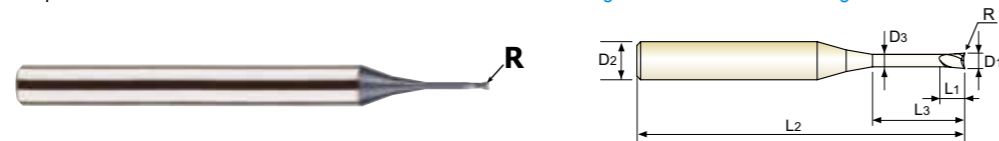

Flat Shank	Page	Plain Shank	Page
END MILL HOLDER	D118-137	HYDRAULIC CHUCK SHRINK FIT HOLDER	D15-46 D47-72
-	-	POWER MILLING CHUCK	D161-176
-	-	ER COLLET CHUCK SK SLIM CHUCK	D73-116 D183-201

Ø0.2-Ø6 Ø7-Ø20

Unit : mm

EDP No.	Corner Radius	Mill Diameter	Shank Diameter	Length of Cut	Length Below Shank	Overall Length	Neck Diameter	Remark
	R	D1	D2	L1	L3	L2	D3	
SEME610070106E	R0.1	0.7	4	1.2	6	45	0.65	-
SEME610070108E	R0.1	0.7	4	1.2	8	45	0.65	-
SEME610070110E	R0.1	0.7	4	1.2	10	45	0.65	-
SEME610070202E	R0.2	0.7	4	1.2	2	45	0.65	-
SEME610070204E	R0.2	0.7	4	1.2	4	45	0.65	-
SEME610070206E	R0.2	0.7	4	1.2	6	45	0.65	-
SEME610070208E	R0.2	0.7	4	1.2	8	45	0.65	-
SEME610070210E	R0.2	0.7	4	1.2	10	45	0.65	-
★ SEME6100800502E	R0.05	0.8	4	1.2	2	45	0.75	-
SEME6100800503E	R0.05	0.8	4	1.2	3	45	0.75	-
★ SEME6100800504E	R0.05	0.8	4	1.2	4	45	0.75	-
★ SEME6100800506E	R0.05	0.8	4	1.2	6	45	0.75	-
SEME6100800508E	R0.05	0.8	4	1.2	8	45	0.75	-
SEME6100800510E	R0.05	0.8	4	1.2	10	45	0.75	-
★ SEME610080102E	R0.1	0.8	4	1.2	2	45	0.75	-
★ SEME610080103E	R0.1	0.8	4	1.2	3	45	0.75	-
★ SEME610080104E	R0.1	0.8	4	1.2	4	45	0.75	-
★ SEME610080106E	R0.1	0.8	4	1.2	6	45	0.75	-
★ SEME610080108E	R0.1	0.8	4	1.2	8	45	0.75	-
SEME610080110E	R0.1	0.8	4	1.2	10	45	0.75	-
★ SEME610080202E	R0.2	0.8	4	1.2	2	45	0.75	-
★ SEME610080203E	R0.2	0.8	4	1.2	3	45	0.75	-
★ SEME610080204E	R0.2	0.8	4	1.2	4	45	0.75	-
★ SEME610080206E	R0.2	0.8	4	1.2	6	45	0.75	-

★ : Stock Item

▶ NEXT PAGE

Size	Corner Radius Tolerance (mm)	Mill Dia. Tolerance (mm)	Shank Dia. Tolerance
up to Ø6	± 0.010	0 ~ - 0.012	h5
over Ø6	± 0.015	0 ~ - 0.015	

◎ : Excellent ○ : Good

ISO Material Description	P										M						K					
	Non-alloy steel					Low alloy steel					High alloyed steel, and tool steel		Stainless steel				Grey cast iron		Nodular cast iron		Malleable cast iron	
VDI 3323	1	2	3	4	5	6	7	8	9	10	11	12	13	14	15	16	17	18	19	20		
HRc	13	25	28	32	30	29	32	38	35	35	15	23	10	10	26	3	25	21	21			
HB	125	190	250	270	300	180	275	300	350	200	325	200	240	180	180	260	160	250	130	230		
Recommend	○	○	◎	◎	◎	○	◎	◎	◎	◎	◎	○	○	○	○	○	○	○	○	○		



PLAIN SHANK SEME61 SERIES

CARBIDE, 2 FLUTE CORNER RADIUS with EXTENDED NECK

● VOLLHARTMETALL, 2 SCHNEIDEN ECKENRADIUS mit ABGESETZTEM SCHAFTTETL
 (●) Fraise carbure, 2 dents, torique, détalonnée
 (●) MD, 2 TAGLIENTI, SCARICATA, TORICA

- ▶ Due to new coating and new tool geometry, outstanding cutting ability and wear resistance.
- ▶ Excellent for cutting prehardened steels, carbon steels, alloy steels of molds and dies, up to HRC55 and machine parts.
- ▶ Available various products like regular length and long shank end mills etc.
- ▶ Available various corner radius end mills, from min. 0.02mm corner radius to max. 2.0mm corner radius.
- ▶ Available more various effective length and overall length end mills than previous standard products.

- ▶ Aufgrund einer neuartigen Beschichtung und neuer Werkzeuggeometrien hervorragende Schnittleistung und Verschleißfestigkeit
- ▶ Ausgezeichnet geeignet für das Fräsen von vorvergrütem Stahl, kohlenstoff Stahl, legiertem Stahl für Formen, bis HRC55 und Maschinenbauteile.
- ▶ Erhältlich in den Schaft-Ausführungen: standard und lang.
- ▶ Erhältlich in verschiedenen Eckradien-Ausführungen: von 0,02mm bis zu 2,0mm Eckradius.
- ▶ Erhältlich in verschiedenen gesamt Längen und effektiv Längen. Mehr Auswahlmöglichkeiten als bei den bisherigen standard Produkten.

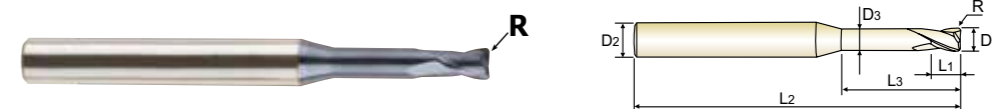

Flat Shank	Page	Plain Shank	Page
END MILL HOLDER	D118-137	HYDRAULIC CHUCK SHRINK FIT HOLDER	D15-46 D47-72
-	-	POWER MILLING CHUCK	D161-176
-	-	ER COLLET CHUCK SK SLIM CHUCK	D73-116 D183-201

Ø0.2-Ø6 Ø7-Ø20

Unit : mm

EDP No.	Corner Radius	Mill Diameter	Shank Diameter	Length of Cut	Length Below Shank	Overall Length	Neck Diameter	Remark
	R	D1	D2	L1	L3	L2	D3	
★ SEME610080208E	R0.2	0.8	4	1.2	8	45	0.75	-
★ SEME610080210E	R0.2	0.8	4	1.2	10	45	0.75	-
★ SEME6101000503E	R0.05	1.0	4	1.5	3	50	0.95	-
★ SEME6101000504E	R0.05	1.0	4	1.5	4	50	0.95	-
SEME6101000505E	R0.05	1.0	4	1.5	5	50	0.95	-
★ SEME6101000506E	R0.05	1.0	4	1.5	6	50	0.95	-
SEME6101000508E	R0.05	1.0	4	1.5	8	50	0.95	-
SEME6101000510E	R0.05	1.0	4	1.5	10	50	0.95	-
SEME6101000512E	R0.05	1.0	4	1.5	12	50	0.95	-
SEME6101000514E	R0.05	1.0	4	1.5	14	50	0.95	-
SEME6101000516E	R0.05	1.0	4	1.5	16	50	0.95	-
SEME6101000520E	R0.05	1.0	4	1.5	20	50	0.95	-
★ SEME610100103E	R0.1	1.0	4	1.5	3	50	0.95	-
★ SEME610100104E	R0.1	1.0	4	1.5	4	50	0.95	-
SEME610100105E	R0.1	1.0	4	1.5	5	50	0.95	-
★ SEME610100106E	R0.1	1.0	4	1.5	6	50	0.95	-
★ SEME610100108E	R0.1	1.0	4	1.5	8	50	0.95	-
★ SEME610100110E	R0.1	1.0	4	1.5	10	50	0.95	-
SEME610100112E	R0.1	1.0	4	1.5	12	50	0.95	-
SEME610100114E	R0.1	1.0	4	1.5	14	50	0.95	-
SEME610100116E	R0.1	1.0	4	1.5	16	50	0.95	-
SEME610100120E	R0.1	1.0	4	1.5	20	50	0.95	-
★ SEME610100203E	R0.2	1.0	4	1.5	3	50	0.95	-
★ SEME610100204E	R0.2	1.0	4	1.5	4	50	0.95	-

★ : Stock Item

▶ NEXT PAGE

Size	Corner Radius Tolerance (mm)	Mill Dia. Tolerance (mm)	Shank Dia. Tolerance
up to Ø6	± 0.010	0 ~ - 0.012	h5
over Ø6	± 0.015	0 ~ - 0.015	

◎ : Excellent ○ : Good

ISO Material Description	P										M						K					
	Non-alloy steel					Low alloy steel					High alloyed steel, and tool steel		Stainless steel				Grey cast iron		Nodular cast iron		Malleable cast iron	
VDI 3323	1	2	3	4	5	6	7	8	9	10	11	12	13	14	15	16	17	18	19	20		
HRc	13	25	28	32	30	29	32	38	35	35	15	23	10	10	26	3	25	21	21			
HB	125	190	250	270	300	180	275	300	350	200	325	200	240	180	180	260	160	250	130	230		
Recommend	○	○	◎	◎	◎	○	◎	◎	◎	◎	◎	○	○	○	○	○	○	○	○	○		

CARBIDE, 2 FLUTE CORNER RADIUS with EXTENDED NECK

- VOLLHARTMETALL, 2 SCHNEIDEN ECKENRADIUS mit ABGESETZTEM SCHAFTTETEL
- () Fraise carbure, 2 dents, torique, détalonnée
- () MD, 2 TAGLIENTI, SCARICATA, TORICA

- ▶ Due to new coating and new tool geometry, outstanding cutting ability and wear resistance.
- ▶ Excellent for cutting prehardened steels, carbon steels, alloy steels of molds and dies, up to HRc55 and machine parts.
- ▶ Available various products like regular length and long shank end mills etc.
- ▶ Available various corner radius end mills, from min. 0.02mm corner radius to max. 2.0mm corner radius.
- ▶ Available more various effective length and overall length end mills than previous standard products.

- ▶ Aufgrund einer neuartigen Beschichtung und neuer Werkzeuggeometrien hervorragende Schnittleistung und Verschleißfestigkeit
- ▶ Ausgezeichnet geeignet für das Fräsen von vorvergrütem Stahl, kohlenstoff Stahl, legiertem Stahl für Formen, bis HRc55 und Maschinenbauteile.
- ▶ Erhältlich in den Schaft-Ausführungen: standard und lang.
- ▶ Erhältlich in verschiedenen Eckradien-Ausführungen: von 0,02mm bis zu 2,0mm Eckradius.
- ▶ Erhältlich in verschiedenen gesamt Längen und effektiv Längen. Mehr Auswahlmöglichkeiten als bei den bisherigen standard Produkten.

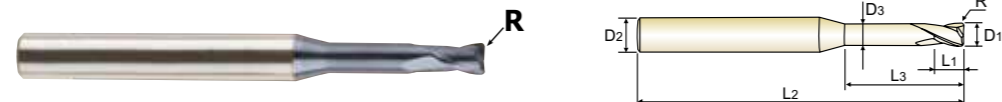

CARBIDE 2 30° ±0.010 ±0.015 PLAIN Coating Y p.C276-283

Flat Shank	Page	Plain Shank	Page
END MILL HOLDER	D118-137	HYDRAULIC CHUCK SHRINK FIT HOLDER	D15-46 D47-72
-	-	POWER MILLING CHUCK	D161-176
-	-	ER COLLET CHUCK SK SLIM CHUCK	D73-116 D183-201

EDP No.	Corner Radius	Mill Diameter	Shank Diameter	Length of Cut	Length Below Shank	Overall Length	Neck Diameter	Remark
	R	D1	D2	L1	L3	L2	D3	
SEME610100205E	R0.2	1.0	4	1.5	5	50	0.95	
★ SEME610100206E	R0.2	1.0	4	1.5	6	50	0.95	-
★ SEME610100208E	R0.2	1.0	4	1.5	8	50	0.95	-
★ SEME610100210E	R0.2	1.0	4	1.5	10	50	0.95	-
★ SEME610100212E	R0.2	1.0	4	1.5	12	50	0.95	-
SEME610100214E	R0.2	1.0	4	1.5	14	50	0.95	-
SEME610100216E	R0.2	1.0	4	1.5	16	50	0.95	-
SEME610100220E	R0.2	1.0	4	1.5	20	50	0.95	-
SEME610100303E	R0.3	1.0	4	1.5	3	50	0.95	-
★ SEME610100304E	R0.3	1.0	4	1.5	4	50	0.95	-
★ SEME610100306E	R0.3	1.0	4	1.5	6	50	0.95	-
★ SEME610100308E	R0.3	1.0	4	1.5	8	50	0.95	-
★ SEME610100310E	R0.3	1.0	4	1.5	10	50	0.95	-
★ SEME610100312E	R0.3	1.0	4	1.5	12	50	0.95	-
SEME610100314E	R0.3	1.0	4	1.5	14	50	0.95	-
SEME610100316E	R0.3	1.0	4	1.5	16	50	0.95	-
SEME610100320E	R0.3	1.0	4	1.5	20	50	0.95	-
SEME6101200503E	R0.05	1.2	4	1.8	3	50	1.15	-
SEME6101200504E	R0.05	1.2	4	1.8	4	50	1.15	-
★ SEME6101200506E	R0.05	1.2	4	1.8	6	50	1.15	-
★ SEME6101200508E	R0.05	1.2	4	1.8	8	50	1.15	-
★ SEME6101200510E	R0.05	1.2	4	1.8	10	50	1.15	-
SEME6101200512E	R0.05	1.2	4	1.8	12	50	1.15	-
SEME6101200516E	R0.05	1.2	4	1.8	16	50	1.15	-

★ : Stock Item ▶ NEXT PAGE

Size	Corner Radius Tolerance (mm)	Mill Dia. Tolerance (mm)	Shank Dia. Tolerance
up to Ø6	± 0.010	0 ~ - 0.012	h5
over Ø6	± 0.015	0 ~ - 0.015	

◎ : Excellent ○ : Good

ISO Material Description	P										M						K			
	Non-alloy steel					Low alloy steel					High alloyed steel, and tool steel		Stainless steel				Grey cast iron		Nodular cast iron	Malleable cast iron
VDI 3323	1	2	3	4	5	6	7	8	9	10	11	12	13	14	15	16	17	18	19	20
HRc	13	25	28	32	30	29	32	38	35	35	15	23	10	10	26	3	25	21		
HB	125	190	250	270	300	180	275	300	350	200	325	200	240	180	180	260	160	250	130	230
Recommend	○	○	◎	◎	◎	○	◎	◎	◎	◎	◎	○	○	○	○	○	○	○	○	○

CARBIDE, 2 FLUTE CORNER RADIUS with EXTENDED NECK

- VOLLHARTMETALL, 2 SCHNEIDEN ECKENRADIUS mit ABGESETZTEM SCHAFTTETEL
- () Fraise carbure, 2 dents, torique, détalonnée
- () MD, 2 TAGLIENTI, SCARICATA, TORICA

- ▶ Due to new coating and new tool geometry, outstanding cutting ability and wear resistance.
- ▶ Excellent for cutting prehardened steels, carbon steels, alloy steels of molds and dies, up to HRc55 and machine parts.
- ▶ Available various products like regular length and long shank end mills etc.
- ▶ Available various corner radius end mills, from min. 0.02mm corner radius to max. 2.0mm corner radius.
- ▶ Available more various effective length and overall length end mills than previous standard products.

- ▶ Aufgrund einer neuartigen Beschichtung und neuer Werkzeuggeometrien hervorragende Schnittleistung und Verschleißfestigkeit
- ▶ Ausgezeichnet geeignet für das Fräsen von vorvergrütem Stahl, kohlenstoff Stahl, legiertem Stahl für Formen, bis HRc55 und Maschinenbauteile.
- ▶ Erhältlich in den Schaft-Ausführungen: standard und lang.
- ▶ Erhältlich in verschiedenen Eckradien-Ausführungen: von 0,02mm bis zu 2,0mm Eckradius.
- ▶ Erhältlich in verschiedenen gesamt Längen und effektiv Längen. Mehr Auswahlmöglichkeiten als bei den bisherigen standard Produkten.

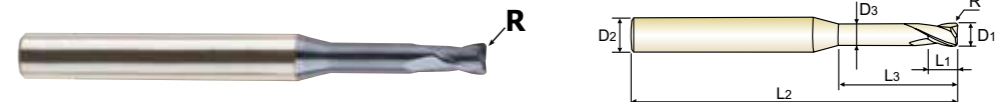

CARBIDE 2 30° ±0.010 ±0.015 PLAIN Coating Y p.C276-283

Flat Shank	Page	Plain Shank	Page
END MILL HOLDER	D118-137	HYDRAULIC CHUCK SHRINK FIT HOLDER	D15-46 D47-72
-	-	POWER MILLING CHUCK	D161-176
-	-	ER COLLET CHUCK SK SLIM CHUCK	D73-116 D183-201

EDP No.	Corner Radius	Mill Diameter	Shank Diameter	Length of Cut	Length Below Shank	Overall Length	Neck Diameter	Remark
	R	D1	D2	L1	L3	L2	D3	
SEME6101200520E	R0.05	1.2	4	1.8	20	50	1.15	-
SEME610120103E	R0.1	1.2	4	1.8	3	50	1.15	-
★ SEME610120104E	R0.1	1.2	4	1.8	4	50	1.15	-
★ SEME610120106E	R0.1	1.2	4	1.8	6	50	1.15	-
★ SEME610120108E	R0.1	1.2	4	1.8	8	50	1.15	-
SEME610120110E	R0.1	1.2	4	1.8	10	50	1.15	-
SEME610120112E	R0.1	1.2	4	1.8	12	50	1.15	-
SEME610120116E	R0.1	1.2	4	1.8	16	50	1.15	-
SEME610120120E	R0.1	1.2	4	1.8	20	50	1.15	-
SEME610120203E	R0.2	1.2	4	1.8	3	50	1.15	-
★ SEME610120204E	R0.2	1.2	4	1.8	4	50	1.15	-
★ SEME610120206E	R0.2	1.2	4	1.8	6	50	1.15	-
★ SEME610120208E	R0.2	1.2	4	1.8	8	50	1.15	-
★ SEME610120210E	R0.2	1.2	4	1.8	10	50	1.15	-
★ SEME610120212E	R0.2	1.2	4	1.8	12	50	1.15	-
SEME610120216E	R0.2	1.2	4	1.8	16	50	1.15	-
SEME610120220E	R0.2	1.2	4	1.8	20	50	1.15	-
SEME610120303E	R0.3	1.2	4	1.8	3	50	1.15	-
★ SEME610120304E	R0.3	1.2	4	1.8	4	50	1.15	-
★ SEME610120306E	R0.3	1.2	4	1.8	6	50	1.15	-
★ SEME610120308E	R0.3	1.2	4	1.8	8	50	1.15	-
★ SEME610120310E	R0.3	1.2	4	1.8	10	50	1.15	-
SEME610120312E	R0.3	1.2	4	1.8	12	50	1.15	-
SEME610120316E	R0.3	1.2	4	1.8	16	50	1.15	-

★ : Stock Item ▶ NEXT PAGE

Size	Corner Radius Tolerance (mm)	Mill Dia. Tolerance (mm)	Shank Dia. Tolerance
up to Ø6	± 0.010	0 ~ - 0.012	h5
over Ø6	± 0.015	0 ~ - 0.015	

◎ : Excellent ○ : Good

ISO Material Description	P										M						K			
	Non-alloy steel					Low alloy steel					High alloyed steel, and tool steel		Stainless steel				Grey cast iron		Nodular cast iron	Malleable cast iron
VDI 3323	1	2	3	4	5	6	7	8	9	10	11	12	13	14	15	16	17	18	19	20
HRc	13	25	28	32	30	29	32	38	35	35	15	23	10	10	26	3	25	21		
HB	125	190	250	270	300	180	275	300	350	200	325	200	240	180	180	260	160	250	130	230
Recommend	○	○	◎	◎	◎	○	◎	◎	◎	◎	◎	○	○	○	○	○	○	○	○	○



PLAIN SHANK SEME61 SERIES

CARBIDE, 2 FLUTE CORNER RADIUS with EXTENDED NECK

- VOLLHARTMETALL, 2 SCHNEIDEN ECKENRADIUS mit ABGESETZTEM SCHAFTTETEL
- () Fraise carbure, 2 dents, torique, détalonnée
- () MD, 2 TAGLIENTI, SCARICATA, TORICA

- ▶ Due to new coating and new tool geometry, outstanding cutting ability and wear resistance.
- ▶ Excellent for cutting prehardened steels, carbon steels, alloy steels of molds and dies, up to HRC55 and machine parts.
- ▶ Available various products like regular length and long shank end mills etc.
- ▶ Available various corner radius end mills, from min. 0.02mm corner radius to max. 2.0mm corner radius.
- ▶ Available more various effective length and overall length end mills than previous standard products.

- ▶ Aufgrund einer neuartigen Beschichtung und neuer Werkzeuggeometrien hervorragende Schnittleistung und Verschleißfestigkeit
- ▶ Ausgezeichnet geeignet für das Fräsen von vorvergütetem Stahl, kohlenstoff Stahl, legiertem Stahl für Formen, bis HRC55 und Maschinenbauteile.
- ▶ Erhältlich in den Schaft-Ausführungen: standard und lang.
- ▶ Erhältlich in verschiedenen Eckradien-Ausführungen: von 0,02mm bis zu 2,0mm Eckradius.
- ▶ Erhältlich in verschiedenen gesamt Längen und effektiv Längen. Mehr Auswahlmöglichkeiten als bei den bisherigen standard Produkten.



Flat Shank	Page	Plain Shank	Page
END MILL HOLDER	D118-137	HYDRAULIC CHUCK SHRINK FIT HOLDER	D15-46 D47-72
-	-	POWER MILLING CHUCK	D161-176
-	-	ER COLLET CHUCK SK SLIM CHUCK	D73-116 D183-201

00.2-06 07-020

Unit : mm

EDP No.	Corner Radius	Mill Diameter	Shank Diameter	Length of Cut	Length Below Shank	Overall Length	Neck Diameter	Remark
	R	D1	D2	L1	L3	L2	D3	
SEME610120320E	R0.3	1.2	4	1.8	20	50	1.15	-
★ SEME6101500504E	R0.05	1.5	4	2.3	4	50	1.45	-
★ SEME6101500506E	R0.05	1.5	4	2.3	6	50	1.45	-
★ SEME6101500508E	R0.05	1.5	4	2.3	8	50	1.45	-
SEME6101500510E	R0.05	1.5	4	2.3	10	50	1.45	-
SEME6101500512E	R0.05	1.5	4	2.3	12	50	1.45	-
SEME6101500514E	R0.05	1.5	4	2.3	14	50	1.45	-
SEME6101500516E	R0.05	1.5	4	2.3	16	50	1.45	-
SEME6101500520E	R0.05	1.5	4	2.3	20	50	1.45	-
SEME6101500522E	R0.05	1.5	4	2.3	22	60	1.45	-
SEME6101500526E	R0.05	1.5	4	2.3	26	60	1.45	-
★ SEME610150104E	R0.1	1.5	4	2.3	4	50	1.45	-
★ SEME610150106E	R0.1	1.5	4	2.3	6	50	1.45	-
★ SEME610150108E	R0.1	1.5	4	2.3	8	50	1.45	-
★ SEME610150110E	R0.1	1.5	4	2.3	10	50	1.45	-
★ SEME610150112E	R0.1	1.5	4	2.3	12	50	1.45	-
SEME610150114E	R0.1	1.5	4	2.3	14	50	1.45	-
SEME610150116E	R0.1	1.5	4	2.3	16	50	1.45	-
SEME610150120E	R0.1	1.5	4	2.3	20	50	1.45	-
SEME610150122E	R0.1	1.5	4	2.3	22	60	1.45	-
SEME610150126E	R0.1	1.5	4	2.3	26	60	1.45	-
★ SEME610150204E	R0.2	1.5	4	2.3	4	50	1.45	-
★ SEME610150206E	R0.2	1.5	4	2.3	6	50	1.45	-
★ SEME610150208E	R0.2	1.5	4	2.3	8	50	1.45	-

★ : Stock Item

▶ NEXT PAGE

Size	Corner Radius Tolerance (mm)	Mill Dia. Tolerance (mm)	Shank Dia. Tolerance
up to Ø6	± 0.010	0 ~ - 0.012	h5
over Ø6	± 0.015	0 ~ - 0.015	

◎ : Excellent ○ : Good

ISO Material Description	P										M						K					
	Non-alloy steel					Low alloy steel					High alloyed steel, and tool steel		Stainless steel				Grey cast iron		Nodular cast iron		Malleable cast iron	
VDI 3323	1	2	3	4	5	6	7	8	9	10	11	12	13	14	15	16	17	18	19	20		
HRc	13	25	28	32	30	29	32	38	35	35	15	23	10	10	26	3	25	21	21			
HB	125	190	250	270	300	180	275	300	350	200	325	200	240	180	180	260	160	250	130	230		
Recommend	○	○	◎	◎	◎	○	◎	◎	◎	◎	◎	○	○	○	○	○	○	○	○	○		



PLAIN SHANK SEME61 SERIES

CARBIDE, 2 FLUTE CORNER RADIUS with EXTENDED NECK

- VOLLHARTMETALL, 2 SCHNEIDEN ECKENRADIUS mit ABGESETZTEM SCHAFTTETEL
- () Fraise carbure, 2 dents, torique, détalonnée
- () MD, 2 TAGLIENTI, SCARICATA, TORICA

- ▶ Due to new coating and new tool geometry, outstanding cutting ability and wear resistance.
- ▶ Excellent for cutting prehardened steels, carbon steels, alloy steels of molds and dies, up to HRC55 and machine parts.
- ▶ Available various products like regular length and long shank end mills etc.
- ▶ Available various corner radius end mills, from min. 0.02mm corner radius to max. 2.0mm corner radius.
- ▶ Available more various effective length and overall length end mills than previous standard products.

- ▶ Aufgrund einer neuartigen Beschichtung und neuer Werkzeuggeometrien hervorragende Schnittleistung und Verschleißfestigkeit
- ▶ Ausgezeichnet geeignet für das Fräsen von vorvergütetem Stahl, kohlenstoff Stahl, legiertem Stahl für Formen, bis HRC55 und Maschinenbauteile.
- ▶ Erhältlich in den Schaft-Ausführungen: standard und lang.
- ▶ Erhältlich in verschiedenen Eckradien-Ausführungen: von 0,02mm bis zu 2,0mm Eckradius.
- ▶ Erhältlich in verschiedenen gesamt Längen und effektiv Längen. Mehr Auswahlmöglichkeiten als bei den bisherigen standard Produkten.



Flat Shank	Page	Plain Shank	Page
END MILL HOLDER	D118-137	HYDRAULIC CHUCK SHRINK FIT HOLDER	D15-46 D47-72
-	-	POWER MILLING CHUCK	D161-176
-	-	ER COLLET CHUCK SK SLIM CHUCK	D73-116 D183-201

00.2-06 07-020

Unit : mm

EDP No.	Corner Radius	Mill Diameter	Shank Diameter	Length of Cut	Length Below Shank	Overall Length	Neck Diameter	Remark
	R	D1	D2	L1	L3	L2	D3	
★ SEME610150210E	R0.2	1.5	4	2.3	10	50	1.45	-
★ SEME610150212E	R0.2	1.5	4	2.3	12	50	1.45	-
★ SEME610150214E	R0.2	1.5	4	2.3	14	50	1.45	-
★ SEME610150216E	R0.2	1.5	4	2.3	16	50	1.45	-
★ SEME610150220E	R0.2	1.5	4	2.3	20	50	1.45	-
SEME610150222E	R0.2	1.5	4	2.3	22	60	1.45	-
SEME610150226E	R0.2	1.5	4	2.3	26	60	1.45	-
★ SEME610150304E	R0.3	1.5	4	2.3	4	50	1.45	-
★ SEME610150306E	R0.3	1.5	4	2.3	6	50	1.45	-
★ SEME610150308E	R0.3	1.5	4	2.3	8	50	1.45	-
★ SEME610150310E	R0.3	1.5	4	2.3	10	50	1.45	-
★ SEME610150312E	R0.3	1.5	4	2.3	12	50	1.45	-
★ SEME610150314E	R0.3	1.5	4	2.3	14	50	1.45	-
★ SEME610150316E	R0.3	1.5	4	2.3	16	50	1.45	-
SEME610150320E	R0.3	1.5	4	2.3	20	50	1.45	-
SEME610150322E	R0.3	1.5	4	2.3	22	60	1.45	-
SEME610150326E	R0.3	1.5	4	2.3	26	60	1.45	-
★ SEME610150504E	R0.5	1.5	4	2.3	4	50	1.45	-
★ SEME610150506E	R0.5	1.5	4	2.3	6	50	1.45	-
★ SEME610150508E	R0.5	1.5	4	2.3	8	50	1.45	-
★ SEME610150510E	R0.5	1.5	4	2.3	10	50	1.45	-
★ SEME610150512E	R0.5	1.5	4	2.3	12	50	1.45	-
SEME610150514E	R0.5	1.5	4	2.3	14	50	1.45	-
★ SEME610150516E	R0.5	1.5	4	2.3	16	50	1.45	-

★ : Stock Item

▶ NEXT PAGE

Size	Corner Radius Tolerance (mm)	Mill Dia. Tolerance (mm)	Shank Dia. Tolerance
up to Ø6	± 0.010	0 ~ - 0.012	h5
over Ø6	± 0.015	0 ~ - 0.015	

◎ : Excellent ○ : Good

ISO Material Description	P										M						K					
	Non-alloy steel					Low alloy steel					High alloyed steel, and tool steel		Stainless steel				Grey cast iron		Nodular cast iron		Malleable cast iron	
VDI 3323	1	2	3	4	5	6	7	8	9	10	11	12	13	14	15	16	17	18	19	20		
HRc	13	25	28	32	30	29	32	38	35	35	15	23	10	10	26	3	25	21	21			
HB	125	190	250	270	300	180	275	300	350	200	325	200	240	180	180	260	160	250	130	230		
Recommend	○	○	◎	◎	◎	○	◎	◎	◎	◎	◎	○	○	○	○	○	○	○	○	○		



PLAIN SHANK SEME61 SERIES

CARBIDE, 2 FLUTE CORNER RADIUS with EXTENDED NECK

- VOLLHARTMETALL, 2 SCHNEIDEN ECKENRADIUS mit ABGESETZTEM SCHAFTTETL
- Fraise carbure, 2 dents, torique, détalonnée
- MD, 2 TAGLIENTI, SCARICATA, TORICA

- Due to new coating and new tool geometry, outstanding cutting ability and wear resistance.
- Excellent for cutting prehardened steels, carbon steels, alloy steels of molds and dies, up to HRC55 and machine parts.
- Available various products like regular length and long shank end mills etc.
- Available various corner radius end mills, from min. 0.02mm corner radius to max. 2.0mm corner radius.
- Available more various effective length and overall length end mills than previous standard products.

- Aufgrund einer neuartigen Beschichtung und neuer Werkzeuggeometrien hervorragende Schnittleistung und Verschleißfestigkeit
- Ausgezeichnet geeignet für das Fräsen von vorvergrütetem Stahl, kohlenstoff Stahl, legiertem Stahl für Formen, bis HRC55 und Maschinenbauteile.
- Erhältlich in den Schaft-Ausführungen: standard und lang.
- Erhältlich in verschiedenen Eckradien-Ausführungen: von 0,02mm bis zu 2,0mm Eckradius.
- Erhältlich in verschiedenen gesamt Längen und effektiv Längen. Mehr Auswahlmöglichkeiten als bei den bisherigen standard Produkten.

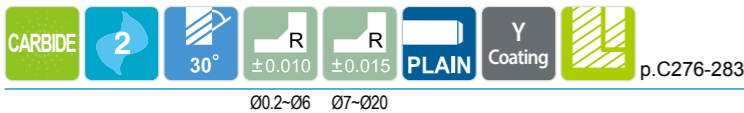
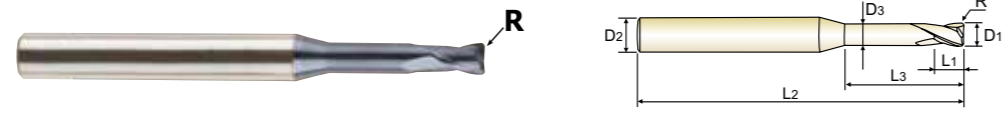

Flat Shank	Page	Plain Shank	Page
END MILL HOLDER	D118-137	HYDRAULIC CHUCK SHRINK FIT HOLDER	D15-46 D47-72
-	-	POWER MILLING CHUCK	D161-176
-	-	ER COLLET CHUCK SK SLIM CHUCK	D73-116 D183-201

EDP No.	Corner Radius	Mill Diameter	Shank Diameter	Length of Cut	Length Below Shank	Overall Length	Neck Diameter	Remark
	R	D1	D2	L1	L3	L2	D3	
SEME610150520E	R0.5	1.5	4	2.3	20	50	1.45	-
SEME610150522E	R0.5	1.5	4	2.3	22	60	1.45	-
SEME610150526E	R0.5	1.5	4	2.3	26	60	1.45	-
★ SEME610200106E	R0.1	2.0	4	3	6	50	1.95	-
★ SEME610200108E	R0.1	2.0	4	3	8	50	1.95	-
★ SEME610200110E	R0.1	2.0	4	3	10	50	1.95	-
★ SEME610200112E	R0.1	2.0	4	3	12	50	1.95	-
SEME610200114E	R0.1	2.0	4	3	14	50	1.95	-
SEME610200116E	R0.1	2.0	4	3	16	50	1.95	-
SEME610200120E	R0.1	2.0	4	3	20	50	1.95	-
SEME610200122E	R0.1	2.0	4	3	22	60	1.95	-
SEME610200126E	R0.1	2.0	4	3	26	60	1.95	-
SEME610200130E	R0.1	2.0	4	3	30	70	1.95	-
★ SEME610200206E	R0.2	2.0	4	3	6	50	1.95	-
★ SEME610200208E	R0.2	2.0	4	3	8	50	1.95	-
★ SEME610200210E	R0.2	2.0	4	3	10	50	1.95	-
★ SEME610200212E	R0.2	2.0	4	3	12	50	1.95	-
★ SEME610200214E	R0.2	2.0	4	3	14	50	1.95	-
★ SEME610200216E	R0.2	2.0	4	3	16	50	1.95	-
★ SEME610200220E	R0.2	2.0	4	3	20	50	1.95	-
SEME610200222E	R0.2	2.0	4	3	22	60	1.95	-
SEME610200226E	R0.2	2.0	4	3	26	60	1.95	-
SEME610200230E	R0.2	2.0	4	3	30	70	1.95	-
★ SEME610200306E	R0.3	2.0	4	3	6	50	1.95	-

Size	Corner Radius Tolerance (mm)	Mill Dia. Tolerance (mm)	Shank Dia. Tolerance
up to Ø6	± 0.010	0 ~ - 0.012	h5
over Ø6	± 0.015	0 ~ - 0.015	

ISO	P										M				K						
Material Description	Non-alloy steel					Low alloy steel					High alloyed steel, and tool steel				Stainless steel		Grey cast iron	Nodular cast iron		Malleable cast iron	
VDI 3323	1	2	3	4	5	6	7	8	9	10	11	12	13	14	15	16	17	18	19	20	
HRc	13	25	28	32	30	29	32	38	35	35	15	35	15	23	10	10	26	3	25	21	
HB	125	190	250	270	300	180	275	300	350	200	200	325	200	240	180	180	260	160	250	130	230
Recommend	○	○	◎	◎	◎	○	◎	◎	◎	◎	◎	◎	◎	◎	◎	○	○	○	○	○	○



PLAIN SHANK SEME61 SERIES

CARBIDE, 2 FLUTE CORNER RADIUS with EXTENDED NECK

- VOLLHARTMETALL, 2 SCHNEIDEN ECKENRADIUS mit ABGESETZTEM SCHAFTTETL
- Fraise carbure, 2 dents, torique, détalonnée
- MD, 2 TAGLIENTI, SCARICATA, TORICA

- Due to new coating and new tool geometry, outstanding cutting ability and wear resistance.
- Excellent for cutting prehardened steels, carbon steels, alloy steels of molds and dies, up to HRC55 and machine parts.
- Available various products like regular length and long shank end mills etc.
- Available various corner radius end mills, from min. 0.02mm corner radius to max. 2.0mm corner radius.
- Available more various effective length and overall length end mills than previous standard products.

- Aufgrund einer neuartigen Beschichtung und neuer Werkzeuggeometrien hervorragende Schnittleistung und Verschleißfestigkeit
- Ausgezeichnet geeignet für das Fräsen von vorvergrütetem Stahl, kohlenstoff Stahl, legiertem Stahl für Formen, bis HRC55 und Maschinenbauteile.
- Erhältlich in den Schaft-Ausführungen: standard und lang.
- Erhältlich in verschiedenen Eckradien-Ausführungen: von 0,02mm bis zu 2,0mm Eckradius.
- Erhältlich in verschiedenen gesamt Längen und effektiv Längen. Mehr Auswahlmöglichkeiten als bei den bisherigen standard Produkten.

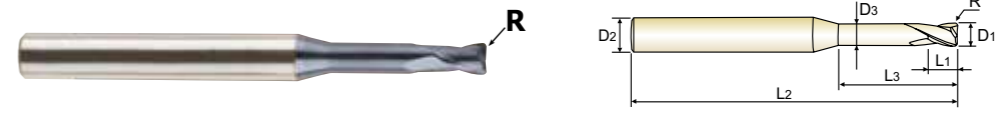

Flat Shank	Page	Plain Shank	Page
END MILL HOLDER	D118-137	HYDRAULIC CHUCK SHRINK FIT HOLDER	D15-46 D47-72
-	-	POWER MILLING CHUCK	D161-176
-	-	ER COLLET CHUCK SK SLIM CHUCK	D73-116 D183-201

EDP No.	Corner Radius	Mill Diameter	Shank Diameter	Length of Cut	Length Below Shank	Overall Length	Neck Diameter	Remark
	R	D1	D2	L1	L3	L2	D3	
★ SEME610200308E	R0.3	2.0	4	3	8	50	1.95	-
★ SEME610200310E	R0.3	2.0	4	3	10	50	1.95	-
★ SEME610200312E	R0.3	2.0	4	3	12	50	1.95	-
★ SEME610200314E	R0.3	2.0	4	3	14	50	1.95	-
★ SEME610200316E	R0.3	2.0	4	3	16	50	1.95	-
★ SEME610200320E	R0.3	2.0	4	3	20	50	1.95	-
SEME610200322E	R0.3	2.0	4	3	22	60	1.95	-
SEME610200326E	R0.3	2.0	4	3	26	60	1.95	-
SEME610200330E	R0.3	2.0	4	3	30	70	1.95	-
★ SEME610200506E	R0.5	2.0	4	3	6	50	1.95	-
★ SEME610200508E	R0.5	2.0	4	3	8	50	1.95	-
★ SEME610200510E	R0.5	2.0	4	3	10	50	1.95	-
★ SEME610200512E	R0.5	2.0	4	3	12	50	1.95	-
★ SEME610200514E	R0.5	2.0	4	3	14	50	1.95	-
★ SEME610200516E	R0.5	2.0	4	3	16	50	1.95	-
★ SEME610200520E	R0.5	2.0	4	3	20	50	1.95	-
SEME610200522E	R0.5	2.0	4	3	22	60	1.95	-
★ SEME610200526E	R0.5	2.0	4	3	26	60	1.95	-
★ SEME610200530E	R0.5	2.0	4	3	30	70	1.95	-
SE5E6102005086SE	R0.5	2.0	6	3	8	50	1.95	-
SEME610250108E	R0.1	2.5	4	4	8	50	2.40	-
SEME610250110E	R0.1	2.5	4	4	10	50	2.40	-
SEME610250112E	R0.1	2.5	4	4	12	50	2.40	-
SEME610250114E	R0.1	2.5	4	4	14	50	2.40	-

Size	Corner Radius Tolerance (mm)	Mill Dia. Tolerance (mm)	Shank Dia. Tolerance
up to Ø6	± 0.010	0 ~ - 0.012	h5
over Ø6	± 0.015	0 ~ - 0.015	

ISO	P										M				K						
Material Description	Non-alloy steel					Low alloy steel					High alloyed steel, and tool steel				Stainless steel		Grey cast iron	Nodular cast iron		Malleable cast iron	
VDI 3323	1	2	3	4	5	6	7	8	9	10	11	12	13	14	15	16	17	18	19	20	
HRc	13	25	28	32	30	29	32	38	35	35	15	35	15	23	10	10	26	3	25	21	
HB	125	190	250	270	300	180	275	300	350	200	200	325	200	240	180	180	260	160	250	130	230
Recommend	○	○	◎	◎	◎	○	◎	◎	◎	◎	◎	◎	◎	◎	◎	○	○	○	○	○	○



PLAIN SHANK SEME61 SERIES

CARBIDE, 2 FLUTE CORNER RADIUS with EXTENDED NECK

- VOLLHARTMETALL, 2 SCHNEIDEN ECKENRADIUS mit ABGESETZTEM SCHAFTTETEL
Fraise carbure, 2 dents, torique, détalonnée
MD, 2 TAGLIENTI, SCARICATA, TORICA

- Due to new coating and new tool geometry, outstanding cutting ability and wear resistance.
Excellent for cutting prehardened steels, carbon steels, alloy steels of molds and dies, up to HRC55 and machine parts.
Available various products like regular length and long shank end mills etc.
Available various corner radius end mills, from min. 0.02mm corner radius to max. 2.0mm corner radius.
Available more various effective length and overall length end mills than previous standard products.

- Aufgrund einer neuartigen Beschichtung und neuer Werkzeuggeometrien hervorragende Schnittleistung und Verschleißfestigkeit
Ausgezeichnet geeignet für das Fräsen von vorvergrütem Stahl, kohlenstoff Stahl, legiertem Stahl für Formen, bis HRC55 und Maschinenbauteile.
Erhältlich in den Schaft-Ausführungen: standard und lang.
Erhältlich in verschiedenen Eckradien-Ausführungen: von 0,02mm bis zu 2,0mm Eckradius.
Erhältlich in verschiedenen gesamt Längen und effektiv Längen. Mehr Auswahlmöglichkeiten als bei den bisherigen standard Produkten.

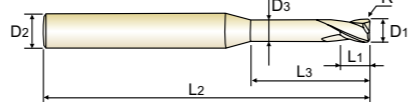

Icons for Carbide, 2 flutes, 30 degree angle, tolerances, plain shank, coating, and ISO standards.

Recommended Toolholder table with columns for Flat Shank, Plain Shank, End Mill Holder, Hydraulic Chuck, Power Milling Chuck, ER Collet Chuck, SK Slim Chuck and corresponding page numbers.

Ø0.2-Ø6 Ø7-Ø20

Unit : mm

Main product table with columns: EDP No., Corner Radius, Mill Diameter, Shank Diameter, Length of Cut, Length Below Shank, Overall Length, Neck Diameter, Remark. Lists various SEME61 series end mills.

* : Stock Item

▶ NEXT PAGE

Size, Corner Radius Tolerance, Mill Dia. Tolerance, Shank Dia. Tolerance table.

◎ : Excellent ○ : Good

ISO material compatibility table with columns for P (Non-alloy steel), M (Stainless steel), K (Grey cast iron), N (Aluminum-wrought alloy), S (Copper and Copper Alloys), H (Hardened steel).



PLAIN SHANK SEME61 SERIES

CARBIDE, 2 FLUTE CORNER RADIUS with EXTENDED NECK

- VOLLHARTMETALL, 2 SCHNEIDEN ECKENRADIUS mit ABGESETZTEM SCHAFTTETEL
Fraise carbure, 2 dents, torique, détalonnée
MD, 2 TAGLIENTI, SCARICATA, TORICA

- Due to new coating and new tool geometry, outstanding cutting ability and wear resistance.
Excellent for cutting prehardened steels, carbon steels, alloy steels of molds and dies, up to HRC55 and machine parts.
Available various products like regular length and long shank end mills etc.
Available various corner radius end mills, from min. 0.02mm corner radius to max. 2.0mm corner radius.
Available more various effective length and overall length end mills than previous standard products.

- Aufgrund einer neuartigen Beschichtung und neuer Werkzeuggeometrien hervorragende Schnittleistung und Verschleißfestigkeit
Ausgezeichnet geeignet für das Fräsen von vorvergrütem Stahl, kohlenstoff Stahl, legiertem Stahl für Formen, bis HRC55 und Maschinenbauteile.
Erhältlich in den Schaft-Ausführungen: standard und lang.
Erhältlich in verschiedenen Eckradien-Ausführungen: von 0,02mm bis zu 2,0mm Eckradius.
Erhältlich in verschiedenen gesamt Längen und effektiv Längen. Mehr Auswahlmöglichkeiten als bei den bisherigen standard Produkten.

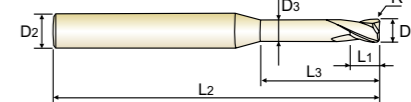

Icons for Carbide, 2 flutes, 30 degree angle, tolerances, plain shank, coating, and ISO standards.

Recommended Toolholder table with columns for Flat Shank, Plain Shank, End Mill Holder, Hydraulic Chuck, Power Milling Chuck, ER Collet Chuck, SK Slim Chuck and corresponding page numbers.

Ø0.2-Ø6 Ø7-Ø20

Unit : mm

Main product table with columns: EDP No., Corner Radius, Mill Diameter, Shank Diameter, Length of Cut, Length Below Shank, Overall Length, Neck Diameter, Remark. Lists various SEME61 series end mills.

* : Stock Item

▶ NEXT PAGE

Size, Corner Radius Tolerance, Mill Dia. Tolerance, Shank Dia. Tolerance table.

◎ : Excellent ○ : Good

ISO material compatibility table with columns for P (Non-alloy steel), M (Stainless steel), K (Grey cast iron), N (Aluminum-wrought alloy), S (Copper and Copper Alloys), H (Hardened steel).



PLAIN SHANK SEME61 SERIES

CARBIDE, 2 FLUTE CORNER RADIUS with EXTENDED NECK

- VOLLHARTMETALL, 2 SCHNEIDEN ECKENRADIUS mit ABGESETZTEM SCHAFTTETL
Fraise carbure, 2 dents, torique, détalonnée
MD, 2 TAGLIENTI, SCARICATA, TORICA

- Due to new coating and new tool geometry, outstanding cutting ability and wear resistance.
Excellent for cutting prehardened steels, carbon steels, alloy steels of molds and dies, up to HRc55 and machine parts.
Available various products like regular length and long shank end mills etc.
Available various corner radius end mills, from min. 0.02mm corner radius to max. 2.0mm corner radius.
Available more various effective length and overall length end mills than previous standard products.

- Aufgrund einer neuartigen Beschichtung und neuer Werkzeuggeometrien hervorragende Schnittleistung und Verschleißfestigkeit
Ausgezeichnet geeignet für das Fräsen von vorvergütetem Stahl, kohlenstoff Stahl, legiertem Stahl für Formen, bis HRc55 und Maschinenbauteile.
Erhältlich in den Schaft-Ausführungen: standard und lang.
Erhältlich in verschiedenen Eckradien-Ausführungen: von 0,02mm bis zu 2,0mm Eckradius.
Erhältlich in verschiedenen gesamt Längen und effektiv Längen. Mehr Auswahlmöglichkeiten als bei den bisherigen standard Produkten.

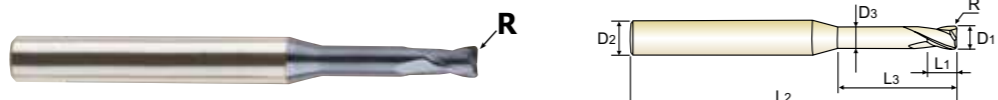

Product icons: CARBIDE, 2 flutes, 30° angle, corner radius R, plain shank, Y coating, and technical drawing reference p.C276-283.

Recommended ToolHolder table with columns for Flat Shank and Plain Shank, listing various holder types and their corresponding page numbers.

Main product specification table with columns: EDP No., Corner Radius, Mill Diameter, Shank Diameter, Length of Cut, Length Below Shank, Overall Length, Neck Diameter, Remark. Lists various SEME61 series end mill models.

Size and tolerance table showing Corner Radius, Mill Dia., and Shank Dia. Tolerance for sizes up to and over Ø6.

ISO material compatibility table with columns for Non-alloy steel, Low alloy steel, High alloyed steel, Stainless steel, Grey cast iron, Nodular cast iron, Malleable cast iron, Aluminum-wrought alloy, Aluminum-cast, alloyed, Copper and Copper Alloys, Non Metallic Materials, Heat Resistant Super Alloys, Titanium Alloys, Hardened steel, Chilled Cast Iron, Hardened Cast Iron.



PLAIN SHANK SEME61 SERIES

CARBIDE, 2 FLUTE CORNER RADIUS with EXTENDED NECK

- VOLLHARTMETALL, 2 SCHNEIDEN ECKENRADIUS mit ABGESETZTEM SCHAFTTETL
Fraise carbure, 2 dents, torique, détalonnée
MD, 2 TAGLIENTI, SCARICATA, TORICA

- Due to new coating and new tool geometry, outstanding cutting ability and wear resistance.
Excellent for cutting prehardened steels, carbon steels, alloy steels of molds and dies, up to HRc55 and machine parts.
Available various products like regular length and long shank end mills etc.
Available various corner radius end mills, from min. 0.02mm corner radius to max. 2.0mm corner radius.
Available more various effective length and overall length end mills than previous standard products.

- Aufgrund einer neuartigen Beschichtung und neuer Werkzeuggeometrien hervorragende Schnittleistung und Verschleißfestigkeit
Ausgezeichnet geeignet für das Fräsen von vorvergütetem Stahl, kohlenstoff Stahl, legiertem Stahl für Formen, bis HRc55 und Maschinenbauteile.
Erhältlich in den Schaft-Ausführungen: standard und lang.
Erhältlich in verschiedenen Eckradien-Ausführungen: von 0,02mm bis zu 2,0mm Eckradius.
Erhältlich in verschiedenen gesamt Längen und effektiv Längen. Mehr Auswahlmöglichkeiten als bei den bisherigen standard Produkten.

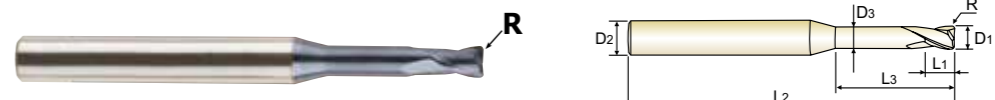

Product icons: CARBIDE, 2 flutes, 30° angle, corner radius R, plain shank, Y coating, and technical drawing reference p.C276-283.

Recommended ToolHolder table with columns for Flat Shank and Plain Shank, listing various holder types and their corresponding page numbers.

Main product specification table with columns: EDP No., Corner Radius, Mill Diameter, Shank Diameter, Length of Cut, Length Below Shank, Overall Length, Neck Diameter, Remark. Lists various SEME61 series end mill models.

Size and tolerance table showing Corner Radius, Mill Dia., and Shank Dia. Tolerance for sizes up to and over Ø6.

ISO material compatibility table with columns for Non-alloy steel, Low alloy steel, High alloyed steel, Stainless steel, Grey cast iron, Nodular cast iron, Malleable cast iron, Aluminum-wrought alloy, Aluminum-cast, alloyed, Copper and Copper Alloys, Non Metallic Materials, Heat Resistant Super Alloys, Titanium Alloys, Hardened steel, Chilled Cast Iron, Hardened Cast Iron.

CARBIDE, 2 FLUTE CORNER RADIUS with EXTENDED NECK

● **VOLLHARTMETALL, 2 SCHNEIDEN ECKENRADIUS mit ABGESETZTEM SCHAFTTETEL**
 (●) **Fraise carbure, 2 dents, torique, détalonnée**
 (●) **MD, 2 TAGLIENTI, SCARICATA, TORICA**

- ▶ Due to new coating and new tool geometry, outstanding cutting ability and wear resistance.
- ▶ Excellent for cutting prehardened steels, carbon steels, alloy steels of molds and dies, up to HRc55 and machine parts.
- ▶ Available various products like regular length and long shank end mills etc.
- ▶ Available various corner radius end mills, from min. 0.02mm corner radius to max. 2.0mm corner radius.
- ▶ Available more various effective length and overall length end mills than previous standard products.

- ▶ Aufgrund einer neuartigen Beschichtung und neuer Werkzeuggeometrien hervorragende Schnittleistung und Verschleißfestigkeit
- ▶ Ausgezeichnet geeignet für das Fräsen von vorvergütetem Stahl, kohlenstoff Stahl, legiertem Stahl für Formen, bis HRc55 und Maschinenbauteile.
- ▶ Erhältlich in den Schaft-Ausführungen: standard und lang.
- ▶ Erhältlich in verschiedenen Eckradien-Ausführungen: von 0,02mm bis zu 2,0mm Eckradius.
- ▶ Erhältlich in verschiedenen gesamt Längen und effektiv Längen. Mehr Auswahlmöglichkeiten als bei den bisherigen standard Produkten.

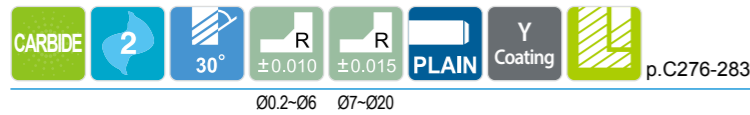
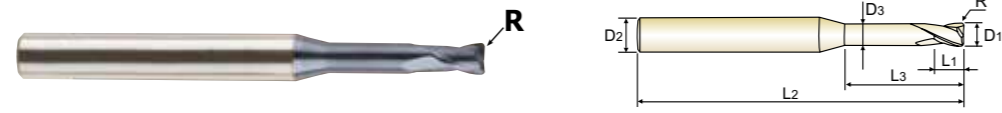

	Flat Shank	Page	Plain Shank	Page
END MILL HOLDER	D118-137		HYDRAULIC CHUCK SHRINK FIT HOLDER	D15-46 D47-72
	-	-	POWER MILLING CHUCK	D161-176
	-	-	ER COLLET CHUCK SK SLIM CHUCK	D73-116 D183-201

EDP No.	Corner Radius	Mill Diameter	Shank Diameter	Length of Cut	Length Below Shank	Overall Length	Neck Diameter	Remark
	R	D1	D2	L1	L3	L2	D3	
SEME610400235E	R0.2	4.0	6	6	35	70	3.85	-
SEME610400240E	R0.2	4.0	6	6	40	80	3.85	-
SEME610400245E	R0.2	4.0	6	6	45	90	3.85	-
SEME610400250E	R0.2	4.0	6	6	50	100	3.85	-
SEME610400310E	R0.3	4.0	6	6	10	50	3.85	-
★ SEME610400312E	R0.3	4.0	6	6	12	50	3.85	-
SEME610400314E	R0.3	4.0	6	6	14	50	3.85	-
★ SEME610400316E	R0.3	4.0	6	6	16	50	3.85	-
★ SEME610400320E	R0.3	4.0	6	6	20	50	3.85	-
★ SEME610400326E	R0.3	4.0	6	6	26	65	3.85	-
SEME610400330E	R0.3	4.0	6	6	30	70	3.85	-
SEME610400335E	R0.3	4.0	6	6	35	70	3.85	-
SEME610400340E	R0.3	4.0	6	6	40	80	3.85	-
SEME610400345E	R0.3	4.0	6	6	45	90	3.85	-
SEME610400350E	R0.3	4.0	6	6	50	100	3.85	-
★ SEME610400510E	R0.5	4.0	6	6	10	50	3.85	-
★ SEME610400512E	R0.5	4.0	6	6	12	50	3.85	-
★ SEME610400514E	R0.5	4.0	6	6	14	60	3.85	-
★ SEME610400516E	R0.5	4.0	6	6	16	60	3.85	-
★ SEME610400520E	R0.5	4.0	6	6	20	60	3.85	-
★ SEME610400526E	R0.5	4.0	6	6	26	65	3.85	-
★ SEME610400530E	R0.5	4.0	6	6	30	70	3.85	-
★ SEME610400535E	R0.5	4.0	6	6	35	70	3.85	-
SEME610400540E	R0.5	4.0	6	6	40	80	3.85	-

★ : Stock Item ▶ NEXT PAGE

Size	Corner Radius Tolerance (mm)	Mill Dia. Tolerance (mm)	Shank Dia. Tolerance
up to Ø6	± 0.010	0 ~ - 0.012	h5
over Ø6	± 0.015	0 ~ - 0.015	

◎ : Excellent ○ : Good

ISO Material Description	P										M						K					
	Non-alloy steel					Low alloy steel					High alloyed steel, and tool steel			Stainless steel			Grey cast iron		Nodular cast iron		Malleable cast iron	
VDI 3323	1	2	3	4	5	6	7	8	9	10	11	12	13	14	15	16	17	18	19	20		
HRc	13	25	28	32	35	38	42	45	48	52	55	58	60	62	63	64	65	66	67	68		
HB	125	190	250	270	300	180	275	300	350	200	325	200	240	180	180	260	160	250	130	230		
Recommend	○	○	◎	◎	◎	◎	◎	◎	◎	◎	◎	◎	◎	◎	◎	◎	◎	◎	◎	◎	◎	

CARBIDE, 2 FLUTE CORNER RADIUS with EXTENDED NECK

● **VOLLHARTMETALL, 2 SCHNEIDEN ECKENRADIUS mit ABGESETZTEM SCHAFTTETEL**
 (●) **Fraise carbure, 2 dents, torique, détalonnée**
 (●) **MD, 2 TAGLIENTI, SCARICATA, TORICA**

- ▶ Due to new coating and new tool geometry, outstanding cutting ability and wear resistance.
- ▶ Excellent for cutting prehardened steels, carbon steels, alloy steels of molds and dies, up to HRc55 and machine parts.
- ▶ Available various products like regular length and long shank end mills etc.
- ▶ Available various corner radius end mills, from min. 0.02mm corner radius to max. 2.0mm corner radius.
- ▶ Available more various effective length and overall length end mills than previous standard products.

- ▶ Aufgrund einer neuartigen Beschichtung und neuer Werkzeuggeometrien hervorragende Schnittleistung und Verschleißfestigkeit
- ▶ Ausgezeichnet geeignet für das Fräsen von vorvergütetem Stahl, kohlenstoff Stahl, legiertem Stahl für Formen, bis HRc55 und Maschinenbauteile.
- ▶ Erhältlich in den Schaft-Ausführungen: standard und lang.
- ▶ Erhältlich in verschiedenen Eckradien-Ausführungen: von 0,02mm bis zu 2,0mm Eckradius.
- ▶ Erhältlich in verschiedenen gesamt Längen und effektiv Längen. Mehr Auswahlmöglichkeiten als bei den bisherigen standard Produkten.

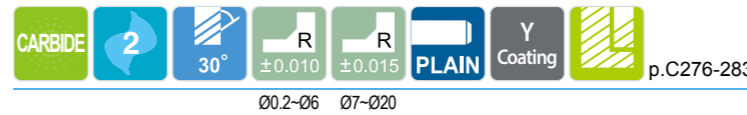
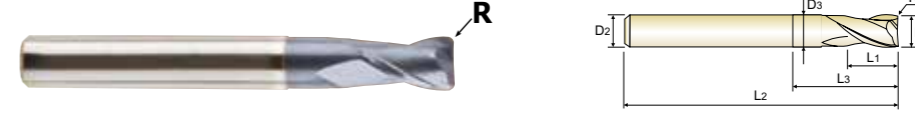

	Flat Shank	Page	Plain Shank	Page
END MILL HOLDER	D118-137		HYDRAULIC CHUCK SHRINK FIT HOLDER	D15-46 D47-72
	-	-	POWER MILLING CHUCK	D161-176
	-	-	ER COLLET CHUCK SK SLIM CHUCK	D73-116 D183-201

EDP No.	Corner Radius	Mill Diameter	Shank Diameter	Length of Cut	Length Below Shank	Overall Length	Neck Diameter	Remark
	R	D1	D2	L1	L3	L2	D3	
SEME610400545E	R0.5	4.0	6	6	45	90	3.85	-
SEME610400550E	R0.5	4.0	6	6	50	100	3.85	-
★ SEME610401010E	R1.0	4.0	6	6	10	50	3.85	-
★ SEME610401012E	R1.0	4.0	6	6	12	50	3.85	-
SEME610401014E	R1.0	4.0	6	6	14	60	3.85	-
★ SEME610401016E	R1.0	4.0	6	6	16	60	3.85	-
★ SEME610401020E	R1.0	4.0	6	6	20	60	3.85	-
★ SEME610401026E	R1.0	4.0	6	6	26	65	3.85	-
★ SEME610401030E	R1.0	4.0	6	6	30	70	3.85	-
SEME610401035E	R1.0	4.0	6	6	35	70	3.85	-
★ SEME610401040E	R1.0	4.0	6	6	40	80	3.85	-
SEME610401045E	R1.0	4.0	6	6	45	90	3.85	-
SEME610401050E	R1.0	4.0	6	6	50	100	3.85	-
SEME6105001E	R0.1	5.0	6	8	15	60	4.85	-
SEME6105002E	R0.2	5.0	6	8	15	60	4.85	-
SEME6105003E	R0.3	5.0	6	8	15	60	4.85	-
SEME6105005E	R0.5	5.0	6	8	15	60	4.85	-
SEME6105010E	R1.0	5.0	6	8	15	60	4.85	-
SEME6105015E	R1.5	5.0	6	8	15	60	4.85	-
SEME6105020E	R2.0	5.0	6	8	15	60	4.85	-
SEME6106001E	R0.1	6.0	6	9	20	60	5.85	Regular
★ SEME6106002E	R0.2	6.0	6	9	20	60	5.85	Regular
★ SEME6106003E	R0.3	6.0	6	9	20	60	5.85	Regular
★ SEME6106005E	R0.5	6.0	6	9	20	60	5.85	Regular

★ : Stock Item ▶ NEXT PAGE

Size	Corner Radius Tolerance (mm)	Mill Dia. Tolerance (mm)	Shank Dia. Tolerance
up to Ø6	± 0.010	0 ~ - 0.012	h5
over Ø6	± 0.015	0 ~ - 0.015	

◎ : Excellent ○ : Good

ISO Material Description	P										M						K					
	Non-alloy steel					Low alloy steel					High alloyed steel, and tool steel			Stainless steel			Grey cast iron		Nodular cast iron		Malleable cast iron	
VDI 3323	1	2	3	4	5	6	7	8	9	10	11	12	13	14	15	16	17	18	19	20		
HRc	13	25	28	32	35	38	42	45	48	52	55	58	60	62	63	64	65	66	67	68		
HB	125	190	250	270	300	180	275	300	350	200	325	200	240	180	180	260	160	250	130	230		
Recommend	○	○	◎	◎	◎	◎	◎	◎	◎	◎	◎	◎	◎	◎	◎	◎	◎	◎	◎	◎	◎	

CARBIDE, 2 FLUTE CORNER RADIUS with EXTENDED NECK

VOLLHARTMETALL, 2 SCHNEIDEN ECKENRADIUS mit ABGESETZTEM SCHAFTTETL
Fraise carbure, 2 dents, torique, détalonnée
MD, 2 TAGLIENTI, SCARICATA, TORICA

- Due to new coating and new tool geometry, outstanding cutting ability and wear resistance.
Excellent for cutting prehardened steels, carbon steels, alloy steels of molds and dies, up to HRC55 and machine parts.
Available various products like regular length and long shank end mills etc.
Available various corner radius end mills, from min. 0.02mm corner radius to max. 2.0mm corner radius.
Available more various effective length and overall length end mills than previous standard products.

- Aufgrund einer neuartigen Beschichtung und neuer Werkzeuggeometrien hervorragende Schnittleistung und Verschleißfestigkeit.
Ausgezeichnet geeignet für das Fräsen von vorvergrütem Stahl, kohlenstoff Stahl, legiertem Stahl für Formen, bis HRC55 und Maschinenbauteile.
Erhältlich in den Schaft-Ausführungen: standard und lang.
Erhältlich in verschiedenen Eckradien-Ausführungen: von 0,02mm bis zu 2,0mm Eckradius.
Erhältlich in verschiedenen gesamt Längen und effektiv Längen. Mehr Auswahlmöglichkeiten als bei den bisherigen standard Produkten.

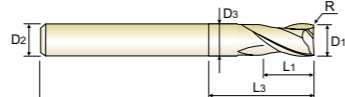

Product icons: CARBIDE, 2 flutes, 30° angle, corner radius R, PLAIN shank, Coating, YG logo, p.C276-283

Recommended ToolHolder table with columns for Flat Shank and Plain Shank, listing various holder types and their page numbers.

Main product table with columns: EDP No., Corner Radius, Mill Diameter, Shank Diameter, Length of Cut, Length Below Shank, Overall Length, Neck Diameter, Remark. Lists various SEME61 models.

Size and tolerance table for the mill end mills, showing corner radius tolerance, mill diameter tolerance, and shank diameter tolerance.

ISO material compatibility chart with columns for P (Non-alloy steel), M (Stainless steel), K (Grey cast iron), N (Aluminum), S (Heat Resistant Super Alloys), and H (Titanium Alloys).

CARBIDE, 2 FLUTE CORNER RADIUS with EXTENDED NECK

VOLLHARTMETALL, 2 SCHNEIDEN ECKENRADIUS mit ABGESETZTEM SCHAFTTETL
Fraise carbure, 2 dents, torique, détalonnée
MD, 2 TAGLIENTI, SCARICATA, TORICA

- Due to new coating and new tool geometry, outstanding cutting ability and wear resistance.
Excellent for cutting prehardened steels, carbon steels, alloy steels of molds and dies, up to HRC55 and machine parts.
Available various products like regular length and long shank end mills etc.
Available various corner radius end mills, from min. 0.02mm corner radius to max. 2.0mm corner radius.
Available more various effective length and overall length end mills than previous standard products.

- Aufgrund einer neuartigen Beschichtung und neuer Werkzeuggeometrien hervorragende Schnittleistung und Verschleißfestigkeit.
Ausgezeichnet geeignet für das Fräsen von vorvergrütem Stahl, kohlenstoff Stahl, legiertem Stahl für Formen, bis HRC55 und Maschinenbauteile.
Erhältlich in den Schaft-Ausführungen: standard und lang.
Erhältlich in verschiedenen Eckradien-Ausführungen: von 0,02mm bis zu 2,0mm Eckradius.
Erhältlich in verschiedenen gesamt Längen und effektiv Längen. Mehr Auswahlmöglichkeiten als bei den bisherigen standard Produkten.



Product icons: CARBIDE, 2 flutes, 30° angle, corner radius R, PLAIN shank, Coating, YG logo, p.C276-283

Recommended ToolHolder table with columns for Flat Shank and Plain Shank, listing various holder types and their page numbers.

Main product table with columns: EDP No., Corner Radius, Mill Diameter, Shank Diameter, Length of Cut, Length Below Shank, Overall Length, Neck Diameter, Remark. Lists various SEME61 models.

Size and tolerance table for the mill end mills, showing corner radius tolerance, mill diameter tolerance, and shank diameter tolerance.

ISO material compatibility chart with columns for P (Non-alloy steel), M (Stainless steel), K (Grey cast iron), N (Aluminum), S (Heat Resistant Super Alloys), and H (Titanium Alloys).



PLAIN SHANK SEME01 SERIES

CARBIDE, 4 FLUTE MULTIPLE HELIX CORNER RADIUS (Short, Regular, Long Shank)

- VOLLHARTMETALL, 4 SCHNEIDEN MEHRSPIRAL ECKENRADIUS
- Fraise carbure, 4 dents, torique, hélice multiple
- MD, 4 TAGLIENTI, TORICA (Serie corta, media e lunga)

- ▶ New coating and tool geometry applied resulting outstanding cutting abilities and wear resistance.
- ▶ Excellent performance when cutting prehardened steels, up to HRC55 which are used for molds & dies.
- ▶ Multiple Helix for 3.0mm and over 3.0mm diameter endmills minimizing vibration and decreasing wear in cutting.
- ▶ Available in short, regular and long shank end mills.

- ▶ Aufgrund einer neuartigen Beschichtung und neuer Werkzeuggeometrien hervorragende Schnittleistung und Verschleißfestigkeit
- ▶ Hervorragende Leistung bei der Zerspaltung von vorvergüteten Stählen bis HRC55, welche im Werkzeug- und Formenbau Verwendung finden.
- ▶ Aufgrund der Multi-Helix (M-Helix) bei Schaftfräsern $\geq 3,0\text{mm } \phi$ werden Vibrationen zuverlässig verhindert und gleichzeitig der Schneidkantenverschleiß verringert.
- ▶ Erhältlich in den Schaft-Ausführungen: standard und lang.

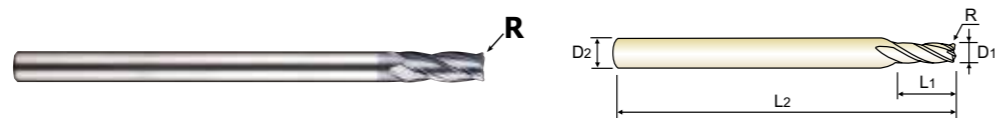

Flat Shank	Page	Plain Shank	Page
END MILL HOLDER	D118-137	HYDRAULIC CHUCK SHRINK FIT HOLDER	D15-46 D47-72
-	-	POWER MILLING CHUCK	D161-176
-	-	ER COLLET CHUCK SK SLIM CHUCK	D73-116 D183-201

Dϕ3, 30° HELIX

Unit : mm

EDP No.	Corner Radius	Mill Diameter	Shank Diameter	Length of Cut	Overall Length	Remark
	R	D1	D2	L1	L2	
SEME010100054SE	R0.05	1.0	4	2.5	50	4mm Shank
SEME01010014SE	R0.1	1.0	4	2.5	50	4mm Shank
SEME01010024SE	R0.2	1.0	4	2.5	50	4mm Shank
SEME01010034SE	R0.3	1.0	4	2.5	50	4mm Shank
SEME01010005E	R0.05	1.0	6	2.5	50	-
★ SEME0101001E	R0.1	1.0	6	2.5	50	-
SEME0101002E	R0.2	1.0	6	2.5	50	-
SEME0101003E	R0.3	1.0	6	2.5	50	-
SEME010120054SE	R0.05	1.2	4	3	50	4mm Shank
SEME01012014SE	R0.1	1.2	4	3	50	4mm Shank
SEME01012024SE	R0.2	1.2	4	3	50	4mm Shank
SEME01012034SE	R0.3	1.2	4	3	50	4mm Shank
SEME01012005E	R0.05	1.2	6	3	50	-
SEME0101201E	R0.1	1.2	6	3	50	-
SEME0101202E	R0.2	1.2	6	3	50	-
SEME0101203E	R0.3	1.2	6	3	50	-
SEME010150054SE	R0.05	1.5	4	4	50	4mm Shank
SEME01015014SE	R0.1	1.5	4	4	50	4mm Shank
SEME01015024SE	R0.2	1.5	4	4	50	4mm Shank
SEME01015034SE	R0.3	1.5	4	4	50	4mm Shank
SEME01015054SE	R0.5	1.5	4	4	50	4mm Shank
SEME01015005E	R0.05	1.5	6	4	50	-
SEME0101501E	R0.1	1.5	6	4	50	-
SEME0101502E	R0.2	1.5	6	4	50	-

★ : Stock Item

▶ NEXT PAGE

Corner Radius Tolerance (mm)	Mill Dia. Tolerance (mm)	Shank Dia. Tolerance
± 0.02	0 ~ - 0.03	h5

◎ : Excellent ○ : Good

ISO Material Description	P										M						K				
	Non-alloy steel					Low alloy steel					High alloyed steel, and tool steel		Stainless steel				Grey cast iron		Nodular cast iron	Malleable cast iron	
VDI 3323	1	2	3	4	5	6	7	8	9	10	11	12	13	14	15	16	17	18	19	20	
HRC	13	25	28	32	30	10	29	32	38	15	35	15	23	10	10	26	3	25	21	21	
HB	125	190	250	270	300	180	275	300	350	200	325	200	240	180	180	260	160	250	130	230	
Recommend	○	○	◎	◎	◎	○	◎	◎	◎	◎	◎	○	○	○	○	○	○	○	○	○	○



PLAIN SHANK SEME01 SERIES

CARBIDE, 4 FLUTE MULTIPLE HELIX CORNER RADIUS (Short, Regular, Long Shank)

- VOLLHARTMETALL, 4 SCHNEIDEN MEHRSPIRAL ECKENRADIUS
- Fraise carbure, 4 dents, torique, hélice multiple
- MD, 4 TAGLIENTI, TORICA (Serie corta, media e lunga)

- ▶ New coating and tool geometry applied resulting outstanding cutting abilities and wear resistance.
- ▶ Excellent performance when cutting prehardened steels, up to HRC55 which are used for molds & dies.
- ▶ Multiple Helix for 3.0mm and over 3.0mm diameter endmills minimizing vibration and decreasing wear in cutting.
- ▶ Available in short, regular and long shank end mills.

- ▶ Aufgrund einer neuartigen Beschichtung und neuer Werkzeuggeometrien hervorragende Schnittleistung und Verschleißfestigkeit
- ▶ Hervorragende Leistung bei der Zerspaltung von vorvergüteten Stählen bis HRC55, welche im Werkzeug- und Formenbau Verwendung finden.
- ▶ Aufgrund der Multi-Helix (M-Helix) bei Schaftfräsern $\geq 3,0\text{mm } \phi$ werden Vibrationen zuverlässig verhindert und gleichzeitig der Schneidkantenverschleiß verringert.
- ▶ Erhältlich in den Schaft-Ausführungen: standard und lang.

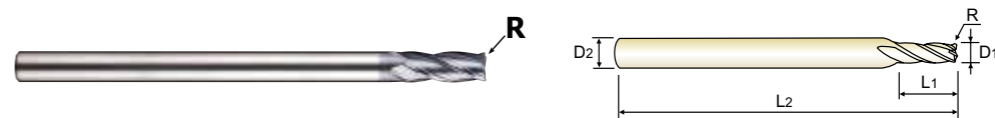

Flat Shank	Page	Plain Shank	Page
END MILL HOLDER	D118-137	HYDRAULIC CHUCK SHRINK FIT HOLDER	D15-46 D47-72
-	-	POWER MILLING CHUCK	D161-176
-	-	ER COLLET CHUCK SK SLIM CHUCK	D73-116 D183-201

Dϕ3, 30° HELIX

Unit : mm

EDP No.	Corner Radius	Mill Diameter	Shank Diameter	Length of Cut	Overall Length	Remark
	R	D1	D2	L1	L2	
SEME0101503E	R0.3	1.5	6	4	50	-
SEME0101505E	R0.5	1.5	6	4	50	-
SEME01020014SE	R0.1	2.0	4	6	50	4mm Shank
SEME01020024SE	R0.2	2.0	4	6	50	4mm Shank
SEME01020034SE	R0.3	2.0	4	6	50	4mm Shank
SEME01020054SE	R0.5	2.0	4	6	50	4mm Shank
★ SEME0102001E	R0.1	2.0	6	6	50	-
★ SEME0102002E	R0.2	2.0	6	6	50	-
SEME0102003E	R0.3	2.0	6	6	50	-
SEME0102005E	R0.5	2.0	6	6	50	-
SEME01025014SE	R0.1	2.5	4	7	60	4mm Shank
SEME01025024SE	R0.2	2.5	4	7	60	4mm Shank
SEME01025034SE	R0.3	2.5	4	7	60	4mm Shank
SEME01025054SE	R0.5	2.5	4	7	60	4mm Shank
SEME0102501E	R0.1	2.5	6	7	60	-
SEME0102502E	R0.2	2.5	6	7	60	-
SEME0102503E	R0.3	2.5	6	7	60	-
SEME0102505E	R0.5	2.5	6	7	60	-
SEME0103001E	R0.1	3.0	6	8	60	-
★ SEME0103002E	R0.2	3.0	6	8	60	-
★ SEME0103003E	R0.3	3.0	6	8	60	-
★ SEME0103005E	R0.5	3.0	6	8	60	-
SEME0103010E	R1.0	3.0	6	8	60	-
SEME0103501E	R0.1	3.5	6	10	70	-

★ : Stock Item

▶ NEXT PAGE

Corner Radius Tolerance (mm)	Mill Dia. Tolerance (mm)	Shank Dia. Tolerance
± 0.02	0 ~ - 0.03	h5

◎ : Excellent ○ : Good

ISO Material Description	P										M						K				
	Non-alloy steel					Low alloy steel					High alloyed steel, and tool steel		Stainless steel				Grey cast iron		Nodular cast iron	Malleable cast iron	
VDI 3323	1	2	3	4	5	6	7	8	9	10	11	12	13	14	15	16	17	18	19	20	
HRC	13	25	28	32	30	10	29	32	38	15	35	15	23	10	10	26	3	25	21	21	
HB	125	190	250	270	300	180	275	300	350	200	325	200	240	180	180	260	160	250	130	230	
Recommend	○	○	◎	◎	◎	○	◎	◎	◎	◎	◎	○	○	○	○	○	○	○	○	○	○



PLAIN SHANK SEME01 SERIES

CARBIDE, 4 FLUTE MULTIPLE HELIX CORNER RADIUS (Short, Regular, Long Shank)

VOLLHARTMETALL, 4 SCHNEIDEN MEHRSPIRAL ECKENRADIUS

Fraise carbure, 4 dents, torique, hélice multiple

MD, 4 TAGLIENTI, TORICA (Serie corta, media e lunga)

- New coating and tool geometry applied resulting outstanding cutting abilities and wear resistance. Excellent performance when cutting prehardened steels, up to HRC55 which are used for molds & dies. Multiple Helix for 3.0mm and over 3.0mm diameter endmills minimizing vibration and decreasing wear in cutting. Available in short, regular and long shank end mills.

- Aufgrund einer neuartigen Beschichtung und neuer Werkzeuggeometrien hervorragende Schnittleistung und Verschleißfestigkeit. Hervorragende Leistung bei der Zerspaltung von vorvergüteten Stählen bis HRC55, welche im Werkzeug- und Formenbau Verwendung finden. Aufgrund der Multi-Helix (M-Helix) bei Schaftfräsern ≥ 3,0mm ø werden Vibrationen zuverlässig verhindert und gleichzeitig der Schneidkantenverschleiß verringert. Erhältlich in den Schaft-Ausführungen: standard und lang.



Recommended Tool Holder table with columns for Flat Shank and Plain Shank, listing various holder types and their corresponding page numbers.

D<ø3, 30° HELIX

Unit : mm

Main product table with columns: EDP No., Corner Radius, Mill Diameter, Shank Diameter, Length of Cut, Overall Length, Remark. Lists various SEME01 series end mills.

★ : Stock Item

▶ NEXT PAGE

Table with 3 columns: Corner Radius Tolerance (mm), Mill Dia. Tolerance (mm), Shank Dia. Tolerance. Values: ± 0.02, 0 ~ - 0.03, h5.

◎ : Excellent ○ : Good

ISO material compatibility table with columns for P (Non-alloy steel), M (Stainless steel), K (Grey cast iron), N (Aluminum), S (Heat Resistant Super Alloys), H (Hardened steel).



PLAIN SHANK SEME01 SERIES

CARBIDE, 4 FLUTE MULTIPLE HELIX CORNER RADIUS (Short, Regular, Long Shank)

VOLLHARTMETALL, 4 SCHNEIDEN MEHRSPIRAL ECKENRADIUS

Fraise carbure, 4 dents, torique, hélice multiple

MD, 4 TAGLIENTI, TORICA (Serie corta, media e lunga)

- New coating and tool geometry applied resulting outstanding cutting abilities and wear resistance. Excellent performance when cutting prehardened steels, up to HRC55 which are used for molds & dies. Multiple Helix for 3.0mm and over 3.0mm diameter endmills minimizing vibration and decreasing wear in cutting. Available in short, regular and long shank end mills.

- Aufgrund einer neuartigen Beschichtung und neuer Werkzeuggeometrien hervorragende Schnittleistung und Verschleißfestigkeit. Hervorragende Leistung bei der Zerspaltung von vorvergüteten Stählen bis HRC55, welche im Werkzeug- und Formenbau Verwendung finden. Aufgrund der Multi-Helix (M-Helix) bei Schaftfräsern ≥ 3,0mm ø werden Vibrationen zuverlässig verhindert und gleichzeitig der Schneidkantenverschleiß verringert. Erhältlich in den Schaft-Ausführungen: standard und lang.



Recommended Tool Holder table with columns for Flat Shank and Plain Shank, listing various holder types and their corresponding page numbers.

D<ø3, 30° HELIX

Unit : mm

Main product table with columns: EDP No., Corner Radius, Mill Diameter, Shank Diameter, Length of Cut, Overall Length, Remark. Lists various SEME01 series end mills.

★ : Stock Item

▶ NEXT PAGE

Table with 3 columns: Corner Radius Tolerance (mm), Mill Dia. Tolerance (mm), Shank Dia. Tolerance. Values: ± 0.02, 0 ~ - 0.03, h5.

◎ : Excellent ○ : Good

ISO material compatibility table with columns for P (Non-alloy steel), M (Stainless steel), K (Grey cast iron), N (Aluminum), S (Heat Resistant Super Alloys), H (Hardened steel).



PLAIN SHANK SEME01 SERIES

CARBIDE, 4 FLUTE MULTIPLE HELIX CORNER RADIUS (Short, Regular, Long Shank)

- VOLLHARTMETALL, 4 SCHNEIDEN MEHRSPIRAL ECKENRADIUS
- Fraise carbure, 4 dents, torique, hélice multiple
- VMD, 4 TAGLIENTI, TORICA (Serie corta, media e lunga)

- ▶ New coating and tool geometry applied resulting outstanding cutting abilities and wear resistance.
- ▶ Excellent performance when cutting prehardened steels, up to HRC55 which are used for molds & dies.
- ▶ Multiple Helix for 3.0mm and over 3.0mm diameter endmills minimizing vibration and decreasing wear in cutting.
- ▶ Available in short, regular and long shank end mills.

- ▶ Aufgrund einer neuartigen Beschichtung und neuer Werkzeuggeometrien hervorragende Schnittleistung und Verschleißfestigkeit
- ▶ Hervorragende Leistung bei der Zerspaltung von vorvergrüteten Stählen bis HRC55, welche im Werkzeug- und Formenbau Verwendung finden.
- ▶ Aufgrund der Multi-Helix (M-Helix) bei Schaftfräsern $\geq 3,0\text{mm } \phi$ werden Vibrationen zuverlässig verhindert und gleichzeitig der Schneidkantenverschleiß verringert.
- ▶ Erhältlich in den Schaft-Ausführungen: standard und lang.



Flat Shank	Page	Plain Shank	Page
END MILL HOLDER	D118-137	HYDRAULIC CHUCK SHRINK FIT HOLDER	D15-46 D47-72
-	-	POWER MILLING CHUCK	D161-176
-	-	ER COLLET CHUCK SK SLIM CHUCK	D73-116 D183-201

Dϕ3, 30° HELIX

Unit : mm

EDP No.	Corner Radius	Mill Diameter	Shank Diameter	Length of Cut	Overall Length	Remark
	R	D1	D2	L1	L2	
SEME0107005E	R0.5	7.0	8	16	90	-
SEME0107010E	R1.0	7.0	8	16	90	-
SEME0107020E	R2.0	7.0	8	16	90	-
★ SEME0108003070E	R0.3	8.0	8	20	70	Short
★ SEME0108005070E	R0.5	8.0	8	20	70	Short
★ SEME0108010070E	R1.0	8.0	8	20	70	Short
SEME0108001E	R0.1	8.0	8	20	100	Regular
★ SEME0108002E	R0.2	8.0	8	20	100	Regular
★ SEME0108003E	R0.3	8.0	8	20	100	Regular
★ SEME0108005E	R0.5	8.0	8	20	100	Regular
★ SEME0108010E	R1.0	8.0	8	20	100	Regular
★ SEME0108015E	R1.5	8.0	8	20	100	Regular
★ SEME0108020E	R2.0	8.0	8	20	100	Regular
SEME0108025E	R2.5	8.0	8	20	100	Regular
SEME0108030E	R3.0	8.0	8	20	100	Regular
SEME0108005120E	R0.5	8.0	8	20	120	Long Shank
SEME0108010120E	R1.0	8.0	8	20	120	Long Shank
SEME0108005150E	R0.5	8.0	8	20	150	Long Shank
SEME0108010150E	R1.0	8.0	8	20	150	Long Shank
SEME0110003075E	R0.3	10.0	10	25	75	Short
SEME0110005075E	R0.5	10.0	10	25	75	Short
SEME0110010075E	R1.0	10.0	10	25	75	Short
SEME0110001E	R0.1	10.0	10	25	100	Regular
SEME0110002E	R0.2	10.0	10	25	100	Regular

★ : Stock Item

▶ NEXT PAGE

Corner Radius Tolerance (mm)	Mill Dia. Tolerance (mm)	Shank Dia. Tolerance
± 0.02	0 ~ - 0.03	h5

◎ : Excellent ○ : Good

ISO Material Description	P										M						K				
	Non-alloy steel					Low alloy steel					High alloyed steel, and tool steel		Stainless steel				Grey cast iron		Nodular cast iron	Malleable cast iron	
VDI 3323	1	2	3	4	5	6	7	8	9	10	11	12	13	14	15	16	17	18	19	20	
HRc	13	25	28	32	30	10	29	32	38	15	35	15	23	10	10	26	3	25	21	21	
HB	125	190	250	270	300	180	275	300	350	200	325	200	240	180	180	260	160	250	130	230	
Recommend	○	○	◎	◎	◎	○	◎	◎	◎	◎	◎	○	○	○	○	○	○	○	○	○	○



PLAIN SHANK SEME01 SERIES

CARBIDE, 4 FLUTE MULTIPLE HELIX CORNER RADIUS (Short, Regular, Long Shank)

- VOLLHARTMETALL, 4 SCHNEIDEN MEHRSPIRAL ECKENRADIUS
- Fraise carbure, 4 dents, torique, hélice multiple
- VMD, 4 TAGLIENTI, TORICA (Serie corta, media e lunga)

- ▶ New coating and tool geometry applied resulting outstanding cutting abilities and wear resistance.
- ▶ Excellent performance when cutting prehardened steels, up to HRC55 which are used for molds & dies.
- ▶ Multiple Helix for 3.0mm and over 3.0mm diameter endmills minimizing vibration and decreasing wear in cutting.
- ▶ Available in short, regular and long shank end mills.

- ▶ Aufgrund einer neuartigen Beschichtung und neuer Werkzeuggeometrien hervorragende Schnittleistung und Verschleißfestigkeit
- ▶ Hervorragende Leistung bei der Zerspaltung von vorvergrüteten Stählen bis HRC55, welche im Werkzeug- und Formenbau Verwendung finden.
- ▶ Aufgrund der Multi-Helix (M-Helix) bei Schaftfräsern $\geq 3,0\text{mm } \phi$ werden Vibrationen zuverlässig verhindert und gleichzeitig der Schneidkantenverschleiß verringert.
- ▶ Erhältlich in den Schaft-Ausführungen: standard und lang.



Flat Shank	Page	Plain Shank	Page
END MILL HOLDER	D118-137	HYDRAULIC CHUCK SHRINK FIT HOLDER	D15-46 D47-72
-	-	POWER MILLING CHUCK	D161-176
-	-	ER COLLET CHUCK SK SLIM CHUCK	D73-116 D183-201

Dϕ3, 30° HELIX

Unit : mm

EDP No.	Corner Radius	Mill Diameter	Shank Diameter	Length of Cut	Overall Length	Remark
	R	D1	D2	L1	L2	
SEME0110003E	R0.3	10.0	10	25	100	Regular
SEME0110005E	R0.5	10.0	10	25	100	Regular
★ SEME0110010E	R1.0	10.0	10	25	100	Regular
★ SEME0110015E	R1.5	10.0	10	25	100	Regular
★ SEME0110020E	R2.0	10.0	10	25	100	Regular
★ SEME0110025E	R2.5	10.0	10	25	100	Regular
SEME0110030E	R3.0	10.0	10	25	100	Regular
SEME0110040E	R4.0	10.0	10	25	100	Regular
SEME0110005130E	R0.5	10.0	10	22	130	Long Shank
SEME0110010130E	R1.0	10.0	10	22	130	Long Shank
SEME0110005150E	R0.5	10.0	10	22	150	Long Shank
SEME0110010150E	R1.0	10.0	10	22	150	Long Shank
★ SEME0111002E	R0.2	11.0	12	25	110	-
★ SEME0111003E	R0.3	11.0	12	25	110	-
SEME0111005E	R0.5	11.0	12	25	110	-
SEME0111010E	R1.0	11.0	12	25	110	-
SEME0111020E	R2.0	11.0	12	25	110	-
SEME0112003080E	R0.3	12.0	12	30	80	Short
SEME0112005080E	R0.5	12.0	12	30	80	Short
SEME0112010080E	R1.0	12.0	12	30	80	Short
SEME0112001E	R0.1	12.0	12	30	110	Regular
SEME0112002E	R0.2	12.0	12	30	110	Regular
SEME0112003E	R0.3	12.0	12	30	110	Regular
★ SEME0112005E	R0.5	12.0	12	30	110	Regular

★ : Stock Item

▶ NEXT PAGE

Corner Radius Tolerance (mm)	Mill Dia. Tolerance (mm)	Shank Dia. Tolerance
± 0.02	0 ~ - 0.03	h5

◎ : Excellent ○ : Good

ISO Material Description	P										M						K				
	Non-alloy steel					Low alloy steel					High alloyed steel, and tool steel		Stainless steel				Grey cast iron		Nodular cast iron	Malleable cast iron	
VDI 3323	1	2	3	4	5	6	7	8	9	10	11	12	13	14	15	16	17	18	19	20	
HRc	13	25	28	32	30	10	29	32	38	15	35	15	23	10	10	26	3	25	21	21	
HB	125	190	250	270	300	180	275	300	350	200	325	200	240	180	180	260	160	250	130	230	
Recommend	○	○	◎	◎	◎	○	◎	◎	◎	◎	◎	○	○	○	○	○	○	○	○	○	○

CARBIDE, 4 FLUTE MULTIPLE HELIX CORNER RADIUS (Short, Regular, Long Shank)

- VOLLHARTMETALL, 4 SCHNEIDEN MEHRSPIRAL ECKENRADIUS
- Fraise carbure, 4 dents, torique, hélice multiple
- VMD, 4 TAGLIENTI, TORICA (Serie corta, media e lunga)

- ▶ New coating and tool geometry applied resulting outstanding cutting abilities and wear resistance.
- ▶ Excellent performance when cutting prehardened steels, up to HRc55 which are used for molds & dies.
- ▶ Multiple Helix for 3.0mm and over 3.0mm diameter endmills minimizing vibration and decreasing wear in cutting.
- ▶ Available in short, regular and long shank end mills.

- ▶ Aufgrund einer neuartigen Beschichtung und neuer Werkzeuggeometrien hervorragende Schnittleistung und Verschleißfestigkeit
- ▶ Hervorragende Leistung bei der Zerspaltung von vorvergüteten Stählen bis HRc55, welche im Werkzeug- und Formenbau Verwendung finden.
- ▶ Aufgrund der Multi-Helix (M-Helix) bei Schaftfräsern $\geq 3,0\text{mm } \phi$ werden Vibrationen zuverlässig verhindert und gleichzeitig der Schneidkantenverschleiß verringert.
- ▶ Erhältlich in den Schaft-Ausführungen: standard und lang.



Flat Shank	Page	Plain Shank	Page
END MILL HOLDER	D118-137	HYDRAULIC CHUCK SHRINK FIT HOLDER	D15-46 D47-72
-	-	POWER MILLING CHUCK	D161-176
-	-	ER COLLET CHUCK SK SLIM CHUCK	D73-116 D183-201

Dϕ3, 30° HELIX

Unit : mm

EDP No.	Corner Radius	Mill Diameter	Shank Diameter	Length of Cut	Overall Length	Remark
	R	D1	D2	L1	L2	
★ SEME0112010E	R1.0	12.0	12	30	110	Regular
★ SEME0112015E	R1.5	12.0	12	30	110	Regular
★ SEME0112020E	R2.0	12.0	12	30	110	Regular
SEME0112025E	R2.5	12.0	12	30	110	Regular
SEME0112030E	R3.0	12.0	12	30	110	Regular
SEME0112040E	R4.0	12.0	12	30	110	Regular
SEME0112050E	R5.0	12.0	12	30	110	Regular
SEME0112005130E	R0.5	12.0	12	30	130	Long Shank
SEME0112010130E	R1.0	12.0	12	30	130	Long Shank
SEME0112005150E	R0.5	12.0	12	30	130	Long Shank
SEME0112010150E	R1.0	12.0	12	30	130	Long Shank
SEME0114005E	R0.5	14.0	16	35	150	-
SEME0114010E	R1.0	14.0	16	35	150	-
SEME0114020E	R2.0	14.0	16	35	150	-
★ SEME0116005E	R0.5	16.0	16	32	150	-
★ SEME0116010E	R1.0	16.0	16	32	150	-
★ SEME0116015E	R1.5	16.0	16	32	150	-
★ SEME0116020E	R2.0	16.0	16	32	150	-
SEME0120005E	R0.5	20.0	20	38	150	-
★ SEME0120010E	R1.0	20.0	20	38	150	-
SEME0120015E	R1.5	20.0	20	38	150	-
★ SEME0120020E	R2.0	20.0	20	38	150	-

★ : Stock Item

Corner Radius Tolerance (mm)	Mill Dia. Tolerance (mm)	Shank Dia. Tolerance
± 0.02	0 ~ - 0.03	h5

◎ : Excellent ○ : Good

ISO Material Description	P										M						K				
	Non-alloy steel					Low alloy steel					High alloyed steel, and tool steel		Stainless steel				Grey cast iron		Nodular cast iron	Malleable cast iron	
VDI 3323	1	2	3	4	5	6	7	8	9	10	11	12	13	14	15	16	17	18	19	20	
HRc	13	25	28	32	38	40	45	50	55	60	65	70	75	80	85	90	95	100	105	110	
HB	125	190	250	270	300	180	275	300	350	200	325	200	240	180	180	260	160	250	130	230	
Recommend	○	○	◎	◎	◎	○	◎	◎	◎	◎	◎	○	○	○	○	○	○	○	○	○	○

CARBIDE, 4 FLUTE MULTIPLE HELIX CORNER RADIUS with EXTENDED NECK

- VOLLHARTMETALL, 4 SCHNEIDEN MEHRSPIRAL ECKENRADIUS mit ABGESETZTEM SCHAFTTETL
- Fraise carbure, 4 dents, torique, hélice multiple, détalonnée
- MD, 4 TAGLIENTI, SCARICATA, TORICA

- ▶ New coating and tool geometry applied resulting outstanding cutting abilities and wear resistance.
- ▶ Excellent performance when cutting prehardened steels, up to HRc55 which are used for molds & dies.
- ▶ Multiple Helix for 3.0mm and over 3.0mm diameter endmills minimizing vibration and decreasing wear in cutting.

- ▶ Aufgrund einer neuartigen Beschichtung und neuer Werkzeuggeometrien hervorragende Schnittleistung und Verschleißfestigkeit
- ▶ Hervorragende Leistung bei der Zerspaltung von vorvergüteten Stählen bis HRc55, welche im Werkzeug- und Formenbau Verwendung finden.
- ▶ Aufgrund der Multi-Helix (M-Helix) bei Schaftfräsern $\geq 3,0\text{mm } \phi$ werden Vibrationen zuverlässig verhindert und gleichzeitig der Schneidkantenverschleiß verringert.

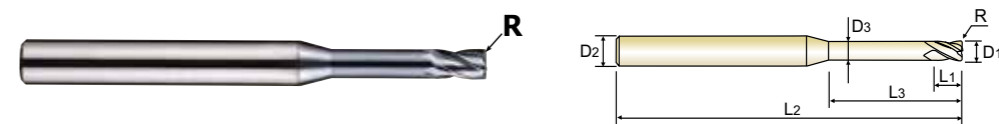

Flat Shank	Page	Plain Shank	Page
END MILL HOLDER	D118-137	HYDRAULIC CHUCK SHRINK FIT HOLDER	D15-46 D47-72
-	-	POWER MILLING CHUCK	D161-176
-	-	ER COLLET CHUCK SK SLIM CHUCK	D73-116 D183-201

Dϕ3, 30° HELIX

Unit : mm

EDP No.	Corner Radius	Mill Diameter	Shank Diameter	Length of Cut	Length Below Shank	Overall Length	Neck Diameter	Remark
	R	D1	D2	L1	L3	L2	D3	
SEME6401000503E	R0.05	1.0	4	1.5	3	50	0.95	-
SEME6401000504E	R0.05	1.0	4	1.5	4	50	0.95	-
SEME6401000506E	R0.05	1.0	4	1.5	6	50	0.95	-
SEME6401000508E	R0.05	1.0	4	1.5	8	50	0.95	-
SEME6401000510E	R0.05	1.0	4	1.5	10	50	0.95	-
SEME6401000512E	R0.05	1.0	4	1.5	12	50	0.95	-
SEME6401000514E	R0.05	1.0	4	1.5	14	50	0.95	-
SEME6401000516E	R0.05	1.0	4	1.5	16	50	0.95	-
SEME6401000520E	R0.05	1.0	4	1.5	20	50	0.95	-
SEME640100103E	R0.1	1.0	4	1.5	3	50	0.95	-
★ SEME640100104E	R0.1	1.0	4	1.5	4	50	0.95	-
★ SEME640100106E	R0.1	1.0	4	1.5	6	50	0.95	-
★ SEME640100108E	R0.1	1.0	4	1.5	8	50	0.95	-
SEME640100110E	R0.1	1.0	4	1.5	10	50	0.95	-
SEME640100112E	R0.1	1.0	4	1.5	12	50	0.95	-
SEME640100114E	R0.1	1.0	4	1.5	14	50	0.95	-
SEME640100116E	R0.1	1.0	4	1.5	16	50	0.95	-
SEME640100120E	R0.1	1.0	4	1.5	20	50	0.95	-
SEME640100203E	R0.2	1.0	4	1.5	3	50	0.95	-
★ SEME640100204E	R0.2	1.0	4	1.5	4	50	0.95	-
★ SEME640100206E	R0.2	1.0	4	1.5	6	50	0.95	-
★ SEME640100208E	R0.2	1.0	4	1.5	8	50	0.95	-
★ SEME640100210E	R0.2	1.0	4	1.5	10	50	0.95	-
SEME640100212E	R0.2	1.0	4	1.5	12	50	0.95	-

★ : Stock Item

Corner Radius Tolerance (mm)	Mill Dia. Tolerance (mm)	Shank Dia. Tolerance
± 0.02	0 ~ - 0.03	h5

◎ : Excellent ○ : Good

ISO Material Description	P										M						K				
	Non-alloy steel					Low alloy steel					High alloyed steel, and tool steel		Stainless steel				Grey cast iron		Nodular cast iron	Malleable cast iron	
VDI 3323	1	2	3	4	5	6	7	8	9	10	11	12	13	14	15	16	17	18	19	20	
HRc	13	25	28	32	38	40	45	50	55	60	65	70	75	80	85	90	95	100	105	110	
HB	125	190	250	270	300	180	275	300	350	200	325	200	240	180	180	260	160	250	130	230	
Recommend	○	○	◎	◎	◎	○	◎	◎	◎	◎	◎	○	○	○	○	○	○	○	○	○	○



CARBIDE, 4 FLUTE MULTIPLE HELIX CORNER RADIUS with EXTENDED NECK

VOLLHARTMETALL, 4 SCHNEIDEN MEHRSPIRAL ECKENRADIUS mit ABGESETZTEM SCHAFTTETL
Fraise carbure, 4 dents, torique, hélice multiple, détalonnée
MD, 4 TAGLIENTI, SCARICATA, TORICA

New coating and tool geometry applied resulting outstanding cutting abilities and wear resistance.
Excellent performance when cutting prehardened steels, up to HRc55 which are used for molds & dies.
Multiple Helix for 3.0mm and over 3.0mm diameter endmills minimizing vibration and decreasing wear in cutting.



Icons for Carbide, 4 flutes, 27°/30°, ±0.02, Plain shank, Coating, Y-shank, and ISO standards. Includes a table for recommended tool holders.

Main product table with columns: EDP No., Corner Radius, Mill Diameter, Shank Diameter, Length of Cut, Length Below Shank, Overall Length, Neck Diameter, Remark. Lists various SEME6401 series end mills.

Star symbol legend: ★ : Stock Item. Tolerance table for Corner Radius (± 0.02), Mill Dia. (0 ~ 0.03), and Shank Dia. (h5).

ISO material compatibility chart showing recommended tool grades for various materials like Non-alloy steel, Low alloy steel, High alloyed steel, etc.



CARBIDE, 4 FLUTE MULTIPLE HELIX CORNER RADIUS with EXTENDED NECK

VOLLHARTMETALL, 4 SCHNEIDEN MEHRSPIRAL ECKENRADIUS mit ABGESETZTEM SCHAFTTETL
Fraise carbure, 4 dents, torique, hélice multiple, détalonnée
MD, 4 TAGLIENTI, SCARICATA, TORICA

New coating and tool geometry applied resulting outstanding cutting abilities and wear resistance.
Excellent performance when cutting prehardened steels, up to HRc55 which are used for molds & dies.
Multiple Helix for 3.0mm and over 3.0mm diameter endmills minimizing vibration and decreasing wear in cutting.



Icons for Carbide, 4 flutes, 27°/30°, ±0.02, Plain shank, Coating, Y-shank, and ISO standards. Includes a table for recommended tool holders.

Main product table with columns: EDP No., Corner Radius, Mill Diameter, Shank Diameter, Length of Cut, Length Below Shank, Overall Length, Neck Diameter, Remark. Lists various SEME6401 series end mills.

Star symbol legend: ★ : Stock Item. Tolerance table for Corner Radius (± 0.02), Mill Dia. (0 ~ 0.03), and Shank Dia. (h5).

ISO material compatibility chart showing recommended tool grades for various materials like Non-alloy steel, Low alloy steel, High alloyed steel, etc.

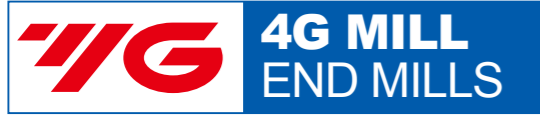

PLAIN SHANK SEME64 SERIES

CARBIDE, 4 FLUTE MULTIPLE HELIX CORNER RADIUS with EXTENDED NECK

VOLLHARTMETALL, 4 SCHNEIDEN MEHRSPIRAL ECKENRADIUS mit ABGESETZTEM SCHAFTTETL
Fraise carbure, 4 dents, torique, hélice multiple, détalonnée
MD, 4 TAGLIENTI, SCARICATA, TORICA

- New coating and tool geometry applied resulting outstanding cutting abilities and wear resistance.
Excellent performance when cutting prehardened steels, up to HRC55 which are used for molds & dies.
Multiple Helix for 3.0mm and over 3.0mm diameter endmills minimizing vibration and decreasing wear in cutting.

- Aufgrund einer neuartigen Beschichtung und neuer Werkzeuggeometrien hervorragende Schnittleistung und Verschleißfestigkeit
Hervorragende Leistung bei der Zerspaltung von vorvergüteten Stählen bis HRC55, welche im Werkzeug- und Formenbau Verwendung finden.
Aufgrund der Multi-Helix (M-Helix) bei Schaftfräsern ≥ 3,0mm ø werden Vibrationen zuverlässig verhindert und gleichzeitig der Schneidkantenverschleiß verringert.

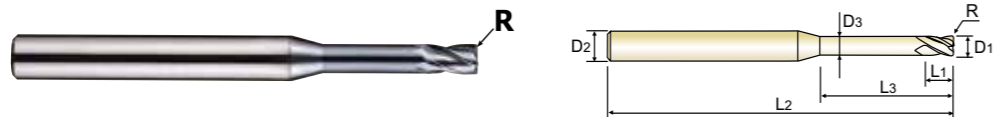

Icons for Carbide, 4 flutes, 27°/30° angle, ±0.02 tolerance, Plain shank, Coating, Y-chuck, and p.C286-289. Includes a table for recommended tool holders.

D<ø3, 30° HELIX

Unit : mm

Table with 9 columns: EDP No., Corner Radius, Mill Diameter, Shank Diameter, Length of Cut, Length Below Shank, Overall Length, Neck Diameter, Remark. Lists various SEME64 models and their specifications.

* : Stock Item

▶ NEXT PAGE

Table showing tolerances for Corner Radius (± 0.02), Mill Dia. (0 ~ -0.03), and Shank Dia. (h5).

◎ : Excellent ○ : Good

Material compatibility table with columns for ISO, Material Description, and various material groups (P, M, K, N, S, H).



PLAIN SHANK SEME64 SERIES

CARBIDE, 4 FLUTE MULTIPLE HELIX CORNER RADIUS with EXTENDED NECK

VOLLHARTMETALL, 4 SCHNEIDEN MEHRSPIRAL ECKENRADIUS mit ABGESETZTEM SCHAFTTETL
Fraise carbure, 4 dents, torique, hélice multiple, détalonnée
MD, 4 TAGLIENTI, SCARICATA, TORICA

- New coating and tool geometry applied resulting outstanding cutting abilities and wear resistance.
Excellent performance when cutting prehardened steels, up to HRC55 which are used for molds & dies.
Multiple Helix for 3.0mm and over 3.0mm diameter endmills minimizing vibration and decreasing wear in cutting.

- Aufgrund einer neuartigen Beschichtung und neuer Werkzeuggeometrien hervorragende Schnittleistung und Verschleißfestigkeit
Hervorragende Leistung bei der Zerspaltung von vorvergüteten Stählen bis HRC55, welche im Werkzeug- und Formenbau Verwendung finden.
Aufgrund der Multi-Helix (M-Helix) bei Schaftfräsern ≥ 3,0mm ø werden Vibrationen zuverlässig verhindert und gleichzeitig der Schneidkantenverschleiß verringert.

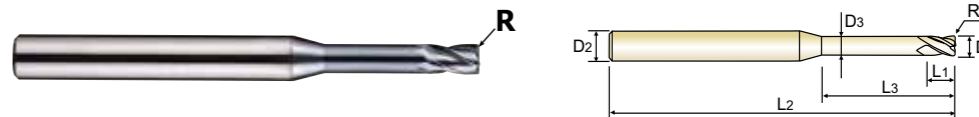

Icons for Carbide, 4 flutes, 27°/30° angle, ±0.02 tolerance, Plain shank, Coating, Y-chuck, and p.C286-289. Includes a table for recommended tool holders.

D<ø3, 30° HELIX

Unit : mm

Table with 9 columns: EDP No., Corner Radius, Mill Diameter, Shank Diameter, Length of Cut, Length Below Shank, Overall Length, Neck Diameter, Remark. Lists various SEME64 models and their specifications.

* : Stock Item

▶ NEXT PAGE

Table showing tolerances for Corner Radius (± 0.02), Mill Dia. (0 ~ -0.03), and Shank Dia. (h5).

◎ : Excellent ○ : Good

Material compatibility table with columns for ISO, Material Description, and various material groups (P, M, K, N, S, H).



PLAIN SHANK SEME64 SERIES

CARBIDE, 4 FLUTE MULTIPLE HELIX CORNER RADIUS with EXTENDED NECK

● VOLLHARTMETALL, 4 SCHNEIDEN MEHRSPIRAL ECKENRADIUS mit ABGESETZTEM SCHAFTTETL
 (●) Fraise carbure, 4 dents, torique, hélice multiple, détalonnée
 (●) MD, 4 TAGLIENTI, SCARICATA, TORICA

- ▶ New coating and tool geometry applied resulting outstanding cutting abilities and wear resistance.
- ▶ Excellent performance when cutting prehardened steels, up to HRC55 which are used for molds & dies.
- ▶ Multiple Helix for 3.0mm and over 3.0mm diameter endmills minimizing vibration and decreasing wear in cutting.

- ▶ Aufgrund einer neuartigen Beschichtung und neuer Werkzeuggeometrien hervorragende Schnittleistung und Verschleißfestigkeit
- ▶ Hervorragende Leistung bei der Zerspaltung von vorvergüteten Stählen bis HRC55, welche im Werkzeug- und Formenbau Verwendung finden.
- ▶ Aufgrund der Multi-Helix (M-Helix) bei Schaftfräsern ≥ 3,0mm Ø werden Vibrationen zuverlässig verhindert und gleichzeitig der Schneidkantenverschleiß verringert.

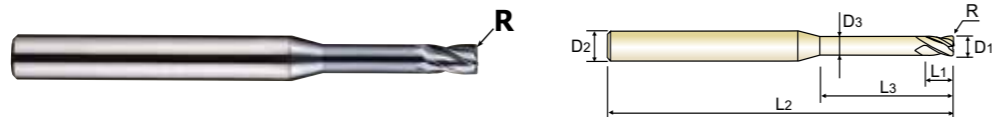

Flat Shank	Page	Plain Shank	Page
END MILL HOLDER	D118-137	HYDRAULIC CHUCK SHRINK FIT HOLDER	D15-46 D47-72
-	-	POWER MILLING CHUCK	D161-176
-	-	ER COLLET CHUCK SK SLIM CHUCK	D73-116 D183-201

D<Ø3, 30° HELIX

Unit : mm

EDP No.	Corner Radius	Mill Diameter	Shank Diameter	Length of Cut	Length Below Shank	Overall Length	Neck Diameter	Remark
	R	D1	D2	L1	L3	L2	D3	
★ SEME640300316E	R0.3	3.0	6	4.5	16	60	2.85	-
★ SEME640300320E	R0.3	3.0	6	4.5	20	60	2.85	-
SEME640300326E	R0.3	3.0	6	4.5	26	65	2.85	-
SEME640300330E	R0.3	3.0	6	4.5	30	70	2.85	-
SEME640300335E	R0.3	3.0	6	4.5	35	70	2.85	-
SEME640300340E	R0.3	3.0	6	4.5	40	80	2.85	-
★ SEME640300508E	R0.5	3.0	6	4.5	8	50	2.85	-
★ SEME640300510E	R0.5	3.0	6	4.5	10	50	2.85	-
★ SEME640300512E	R0.5	3.0	6	4.5	12	50	2.85	-
SEME640300514E	R0.5	3.0	6	4.5	14	60	2.85	-
★ SEME640300516E	R0.5	3.0	6	4.5	16	60	2.85	-
★ SEME640300520E	R0.5	3.0	6	4.5	20	60	2.85	-
★ SEME640300526E	R0.5	3.0	6	4.5	26	65	2.85	-
★ SEME640300530E	R0.5	3.0	6	4.5	30	70	2.85	-
SEME640300535E	R0.5	3.0	6	4.5	35	70	2.85	-
SEME640300540E	R0.5	3.0	6	4.5	40	80	2.85	-
★ SEME640301008E	R1.0	3.0	6	4.5	8	50	2.85	-
★ SEME640301010E	R1.0	3.0	6	4.5	10	50	2.85	-
★ SEME640301012E	R1.0	3.0	6	4.5	12	50	2.85	-
SEME640301014E	R1.0	3.0	6	4.5	14	60	2.85	-
★ SEME640301016E	R1.0	3.0	6	4.5	16	60	2.85	-
★ SEME640301020E	R1.0	3.0	6	4.5	20	60	2.85	-
SEME640301026E	R1.0	3.0	6	4.5	26	65	2.85	-
★ SEME640301030E	R1.0	3.0	6	4.5	30	70	2.85	-

★ : Stock Item

▶ NEXT PAGE

Corner Radius Tolerance (mm)	Mill Dia. Tolerance (mm)	Shank Dia. Tolerance
± 0.02	0 ~ - 0.03	h5

◎ : Excellent ○ : Good

ISO Material Description	P										M						K					
	Non-alloy steel					Low alloy steel					High alloyed steel, and tool steel		Stainless steel				Grey cast iron		Nodular cast iron		Malleable cast iron	
VDI 3323	1	2	3	4	5	6	7	8	9	10	11	12	13	14	15	16	17	18	19	20		
HRc	13	25	28	32	38	42	48	52	58	62	68	72	78	82	88	92	98	102	108	112		
HB	125	190	250	270	300	180	275	300	350	200	325	200	240	180	10	26	3	25	130	230		
Recommend	○	◎	◎	◎	◎	○	◎	◎	◎	◎	◎	○	○	○	○	○	○	○	○	○	○	



PLAIN SHANK SEME64 SERIES

CARBIDE, 4 FLUTE MULTIPLE HELIX CORNER RADIUS with EXTENDED NECK

● VOLLHARTMETALL, 4 SCHNEIDEN MEHRSPIRAL ECKENRADIUS mit ABGESETZTEM SCHAFTTETL
 (●) Fraise carbure, 4 dents, torique, hélice multiple, détalonnée
 (●) MD, 4 TAGLIENTI, SCARICATA, TORICA

- ▶ New coating and tool geometry applied resulting outstanding cutting abilities and wear resistance.
- ▶ Excellent performance when cutting prehardened steels, up to HRC55 which are used for molds & dies.
- ▶ Multiple Helix for 3.0mm and over 3.0mm diameter endmills minimizing vibration and decreasing wear in cutting.

- ▶ Aufgrund einer neuartigen Beschichtung und neuer Werkzeuggeometrien hervorragende Schnittleistung und Verschleißfestigkeit
- ▶ Hervorragende Leistung bei der Zerspaltung von vorvergüteten Stählen bis HRC55, welche im Werkzeug- und Formenbau Verwendung finden.
- ▶ Aufgrund der Multi-Helix (M-Helix) bei Schaftfräsern ≥ 3,0mm Ø werden Vibrationen zuverlässig verhindert und gleichzeitig der Schneidkantenverschleiß verringert.

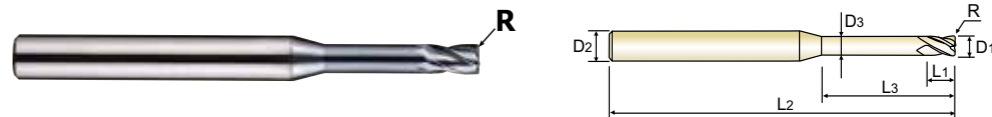

Flat Shank	Page	Plain Shank	Page
END MILL HOLDER	D118-137	HYDRAULIC CHUCK SHRINK FIT HOLDER	D15-46 D47-72
-	-	POWER MILLING CHUCK	D161-176
-	-	ER COLLET CHUCK SK SLIM CHUCK	D73-116 D183-201

D<Ø3, 30° HELIX

Unit : mm

EDP No.	Corner Radius	Mill Diameter	Shank Diameter	Length of Cut	Length Below Shank	Overall Length	Neck Diameter	Remark
	R	D1	D2	L1	L3	L2	D3	
SEME640301035E	R1.0	3.0	6	4.5	35	70	2.85	-
SEME640301040E	R1.0	3.0	6	4.5	40	80	2.85	-
★ SEME640400110E	R0.1	4.0	6	6	10	50	3.85	-
★ SEME640400112E	R0.1	4.0	6	6	12	50	3.85	-
SEME640400114E	R0.1	4.0	6	6	14	60	3.85	-
★ SEME640400116E	R0.1	4.0	6	6	16	60	3.85	-
★ SEME640400120E	R0.1	4.0	6	6	20	60	3.85	-
SEME640400126E	R0.1	4.0	6	6	26	65	3.85	-
SEME640400130E	R0.1	4.0	6	6	30	70	3.85	-
SEME640400135E	R0.1	4.0	6	6	35	70	3.85	-
SEME640400140E	R0.1	4.0	6	6	40	80	3.85	-
SEME640400145E	R0.1	4.0	6	6	45	90	3.85	-
SEME640400150E	R0.1	4.0	6	6	50	100	3.85	-
★ SEME640400210E	R0.2	4.0	6	6	10	50	3.85	-
★ SEME640400212E	R0.2	4.0	6	6	12	50	3.85	-
SEME640400214E	R0.2	4.0	6	6	14	60	3.85	-
★ SEME640400216E	R0.2	4.0	6	6	16	60	3.85	-
★ SEME640400220E	R0.2	4.0	6	6	20	60	3.85	-
SEME640400224E	R0.2	4.0	6	6	24	65	3.85	-
★ SEME640400226E	R0.2	4.0	6	6	26	65	3.85	-
SEME640400230E	R0.2	4.0	6	6	30	70	3.85	-
SEME640400235E	R0.2	4.0	6	6	35	70	3.85	-
SEME640400240E	R0.2	4.0	6	6	40	80	3.85	-
SEME640400245E	R0.2	4.0	6	6	45	90	3.85	-

★ : Stock Item

▶ NEXT PAGE

Corner Radius Tolerance (mm)	Mill Dia. Tolerance (mm)	Shank Dia. Tolerance
± 0.02	0 ~ - 0.03	h5

◎ : Excellent ○ : Good

ISO Material Description	P										M						K					
	Non-alloy steel					Low alloy steel					High alloyed steel, and tool steel		Stainless steel				Grey cast iron		Nodular cast iron		Malleable cast iron	
VDI 3323	1	2	3	4	5	6	7	8	9	10	11	12	13	14	15	16	17	18	19	20		
HRc	13	25	28	32	38	42	48	52	58	62	68	72	78	82	88	92	98	102	108	112		
HB	125	190	250	270	300	180	275	300	350	200	325	200	240	180	10	26	3	25	130	230		
Recommend	○	◎	◎	◎	◎	○	◎	◎	◎	◎	◎	○	○	○	○	○	○	○	○	○	○	

CARBIDE, 4 FLUTE MULTIPLE HELIX CORNER RADIUS with EXTENDED NECK

● **VOLLHARTMETALL, 4 SCHNEIDEN MEHRSPIRAL ECKENRADIUS mit ABGESETZTEM SCHAFTTETL**
 (●) **Fraise carbure, 4 dents, torique, hélice multiple, détalonnée**
 (●) **MD, 4 TAGLIENTI, SCARICATA, TORICA**

- ▶ New coating and tool geometry applied resulting outstanding cutting abilities and wear resistance.
- ▶ Excellent performance when cutting prehardened steels, up to HRC55 which are used for molds & dies.
- ▶ Multiple Helix for 3.0mm and over 3.0mm diameter endmills minimizing vibration and decreasing wear in cutting.

- ▶ Aufgrund einer neuartigen Beschichtung und neuer Werkzeuggeometrien hervorragende Schnittleistung und Verschleißfestigkeit
- ▶ Hervorragende Leistung bei der Zerspaltung von vorvergüteten Stählen bis HRC55, welche im Werkzeug- und Formenbau Verwendung finden.
- ▶ Aufgrund der Multi-Helix (M-Helix) bei Schaftfräsern ≥ 3,0mm Ø werden Vibrationen zuverlässig verhindert und gleichzeitig der Schneidkantenverschleiß verringert.

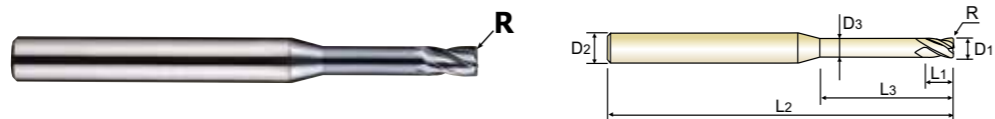

Flat Shank	Page	Plain Shank	Page
END MILL HOLDER	D118-137	HYDRAULIC CHUCK SHRINK FIT HOLDER	D15-46 D47-72
-	-	POWER MILLING CHUCK	D161-176
-	-	ER COLLET CHUCK SK SLIM CHUCK	D73-116 D183-201

D<Ø3, 30° HELIX

Unit : mm

EDP No.	Corner Radius	Mill Diameter	Shank Diameter	Length of Cut	Length Below Shank	Overall Length	Neck Diameter	Remark
	R	D1	D2	L1	L3	L2	D3	
SEME640400250E	R0.2	4.0	6	6	50	100	3.85	-
★ SEME640400310E	R0.3	4.0	6	6	10	50	3.85	-
★ SEME640400312E	R0.3	4.0	6	6	12	50	3.85	-
★ SEME640400314E	R0.3	4.0	6	6	14	60	3.85	-
★ SEME640400316E	R0.3	4.0	6	6	16	60	3.85	-
★ SEME640400320E	R0.3	4.0	6	6	20	60	3.85	-
★ SEME640400326E	R0.3	4.0	6	6	26	65	3.85	-
SEME640400330E	R0.3	4.0	6	6	30	70	3.85	-
SEME640400335E	R0.3	4.0	6	6	35	70	3.85	-
SEME640400340E	R0.3	4.0	6	6	40	80	3.85	-
SEME640400345E	R0.3	4.0	6	6	45	90	3.85	-
SEME640400350E	R0.3	4.0	6	6	50	100	3.85	-
★ SEME640400510E	R0.5	4.0	6	6	10	50	3.85	-
★ SEME640400512E	R0.5	4.0	6	6	12	50	3.85	-
★ SEME640400514E	R0.5	4.0	6	6	14	60	3.85	-
★ SEME640400516E	R0.5	4.0	6	6	16	60	3.85	-
★ SEME640400520E	R0.5	4.0	6	6	20	60	3.85	-
★ SEME640400526E	R0.5	4.0	6	6	26	65	3.85	-
★ SEME640400530E	R0.5	4.0	6	6	30	70	3.85	-
★ SEME640400535E	R0.5	4.0	6	6	35	70	3.85	-
★ SEME640400540E	R0.5	4.0	6	6	40	80	3.85	-
SEME640400545E	R0.5	4.0	6	6	45	90	3.85	-
SEME640400550E	R0.5	4.0	6	6	50	100	3.85	-
★ SEME640401010E	R1.0	4.0	6	6	10	50	3.85	-

★ : Stock Item

▶ NEXT PAGE

Corner Radius Tolerance (mm)	Mill Dia. Tolerance (mm)	Shank Dia. Tolerance
± 0.02	0 ~ - 0.03	h5

◎ : Excellent ○ : Good

ISO Material Description	P										M				K					
	Non-alloy steel					Low alloy steel					High alloyed steel, and tool steel		Stainless steel		Grey cast iron	Nodular cast iron		Malleable cast iron		
VDI 3323	1	2	3	4	5	6	7	8	9	10	11	12	13	14	15	16	17	18	19	20
HRc	13	25	28	32	38	42	48	52	58	63	68	73	78	83	88	93	98	103	108	113
HB	125	190	250	270	300	180	275	300	350	200	325	200	240	180	180	260	160	250	130	230
Recommend	◎	◎	◎	◎	◎	◎	◎	◎	◎	◎	◎	◎	◎	◎	◎	◎	◎	◎	◎	◎

ISO Material Description	N										S					H					
	Aluminum-wrought alloy		Aluminum-cast, alloyed			Copper and Copper Alloys (Bronze / Brass)					Non Metallic Materials		Heat Resistant Super Alloys			Titanium Alloys		Hardened steel	Chilled Cast Iron	Hardened Cast Iron	
VDI 3323	21	22	23	24	25	26	27	28	29	30	31	32	33	34	35	36	37	38	39	40	41
HRc	21	30	25	38	34	55	60	42	55	55	60	42	55	55	60	42	55	55	60	42	55
HB	60	100	75	90	130	110	90	100			200	280	250	350	320	400 Rm	1050 Rm	550	630	400	550
Recommend	◎	◎	◎	◎	◎	◎	◎	◎	◎	◎	◎	◎	◎	◎	◎	◎	◎	◎	◎	◎	◎

CARBIDE, 4 FLUTE MULTIPLE HELIX CORNER RADIUS with EXTENDED NECK

● **VOLLHARTMETALL, 4 SCHNEIDEN MEHRSPIRAL ECKENRADIUS mit ABGESETZTEM SCHAFTTETL**
 (●) **Fraise carbure, 4 dents, torique, hélice multiple, détalonnée**
 (●) **MD, 4 TAGLIENTI, SCARICATA, TORICA**

- ▶ New coating and tool geometry applied resulting outstanding cutting abilities and wear resistance.
- ▶ Excellent performance when cutting prehardened steels, up to HRC55 which are used for molds & dies.
- ▶ Multiple Helix for 3.0mm and over 3.0mm diameter endmills minimizing vibration and decreasing wear in cutting.

- ▶ Aufgrund einer neuartigen Beschichtung und neuer Werkzeuggeometrien hervorragende Schnittleistung und Verschleißfestigkeit
- ▶ Hervorragende Leistung bei der Zerspaltung von vorvergüteten Stählen bis HRC55, welche im Werkzeug- und Formenbau Verwendung finden.
- ▶ Aufgrund der Multi-Helix (M-Helix) bei Schaftfräsern ≥ 3,0mm Ø werden Vibrationen zuverlässig verhindert und gleichzeitig der Schneidkantenverschleiß verringert.

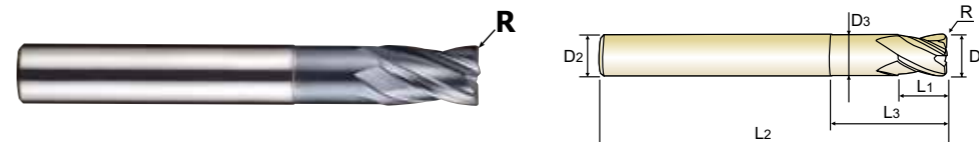

Flat Shank	Page	Plain Shank	Page
END MILL HOLDER	D118-137	HYDRAULIC CHUCK SHRINK FIT HOLDER	D15-46 D47-72
-	-	POWER MILLING CHUCK	D161-176
-	-	ER COLLET CHUCK SK SLIM CHUCK	D73-116 D183-201

D<Ø3, 30° HELIX

Unit : mm

EDP No.	Corner Radius	Mill Diameter	Shank Diameter	Length of Cut	Length Below Shank	Overall Length	Neck Diameter	Remark
	R	D1	D2	L1	L3	L2	D3	
★ SEME640401012E	R1.0	4.0	6	6	12	50	3.85	-
SEME640401014E	R1.0	4.0	6	6	14	60	3.85	-
★ SEME640401016E	R1.0	4.0	6	6	16	60	3.85	-
★ SEME640401020E	R1.0	4.0	6	6	20	60	3.85	-
★ SEME640401026E	R1.0	4.0	6	6	26	65	3.85	-
★ SEME640401030E	R1.0	4.0	6	6	30	70	3.85	-
SEME640401035E	R1.0	4.0	6	6	35	70	3.85	-
SEME640401040E	R1.0	4.0	6	6	40	80	3.85	-
SEME640401045E	R1.0	4.0	6	6	45	90	3.85	-
SEME640401050E	R1.0	4.0	6	6	50	100	3.85	-
SEME6405001E	R0.1	5.0	6	8	15	60	4.85	-
SEME6405002E	R0.2	5.0	6	8	15	60	4.85	-
SEME6405003E	R0.3	5.0	6	8	15	60	4.85	-
SEME6405005E	R0.5	5.0	6	8	15	60	4.85	-
SEME6405010E	R1.0	5.0	6	8	15	60	4.85	-
SEME6405015E	R1.5	5.0	6	8	15	60	4.85	-
SEME6405020E	R2.0	5.0	6	8	15	60	4.85	-
SEME6406001E	R0.1	6.0	6	9	20	60	5.85	Regular
★ SEME6406002E	R0.2	6.0	6	9	20	60	5.85	Regular
★ SEME6406003E	R0.3	6.0	6	9	20	60	5.85	Regular
★ SEME6406005E	R0.5	6.0	6	9	20	60	5.85	Regular
★ SEME6406010E	R1.0	6.0	6	9	20	60	5.85	Regular
SEME6406015E	R1.5	6.0	6	9	20	60	5.85	Regular
SEME6406020E	R2.0	6.0	6	9	20	60	5.85	Regular

★ : Stock Item

▶ NEXT PAGE

Corner Radius Tolerance (mm)	Mill Dia. Tolerance (mm)	Shank Dia. Tolerance
± 0.02	0 ~ - 0.03	h5

◎ : Excellent ○ : Good

ISO Material Description	P										M				K					
	Non-alloy steel					Low alloy steel					High alloyed steel, and tool steel		Stainless steel		Grey cast iron	Nodular cast iron		Malleable cast iron		
VDI 3323	1	2	3	4	5	6	7	8	9	10	11	12	13	14	15	16	17	18	19	20
HRc	13	25	28	32	38	42	48	52	58	63	68	73	78	83	88	93	98	103	108	113
HB	125	190	250	270	300	180	275	300	350	200	325	200	240	180	180	260	160	250	130	230
Recommend	◎	◎	◎	◎	◎	◎	◎	◎	◎	◎	◎	◎	◎	◎	◎	◎	◎	◎	◎	◎

ISO Material Description	N										S					H					
	Aluminum-wrought alloy		Aluminum-cast, alloyed			Copper and Copper Alloys (Bronze / Brass)					Non Metallic Materials		Heat Resistant Super Alloys			Titanium Alloys		Hardened steel	Chilled Cast Iron	Hardened Cast Iron	
VDI 3323	21	22	23	24	25	26	27	28	29	30	31	32	33	34	35	36	37	38	39	40	41
HRc	21	30	25	38	34	55	60	42	55	55	60	42	55	55	60	42	55	55	60	42	55
HB	60	100	75	90	130	110	90	100			200	280	250	350	320	400 Rm	1050 Rm	550	630	400	550
Recommend	◎	◎	◎	◎	◎	◎	◎	◎	◎	◎	◎	◎	◎	◎	◎	◎	◎	◎	◎	◎	◎

CARBIDE, 4 FLUTE MULTIPLE HELIX CORNER RADIUS with EXTENDED NECK

● **VOLLHARTMETALL, 4 SCHNEIDEN MEHRSPIRAL ECKENRADIUS mit ABGESETZTEM SCHAFTTETL**
 (●) **Fraise carbure, 4 dents, torique, hélice multiple, détalonnée**
 (●) **MD, 4 TAGLIENTI, SCARICATA, TORICA**

- ▶ New coating and tool geometry applied resulting outstanding cutting abilities and wear resistance.
- ▶ Excellent performance when cutting prehardened steels, up to HRC55 which are used for molds & dies.
- ▶ Multiple Helix for 3.0mm and over 3.0mm diameter endmills minimizing vibration and decreasing wear in cutting.

- ▶ Aufgrund einer neuartigen Beschichtung und neuer Werkzeuggeometrien hervorragende Schnittleistung und Verschleißfestigkeit
- ▶ Hervorragende Leistung bei der Zerspaltung von vorvergüteten Stählen bis HRC55, welche im Werkzeug- und Formenbau Verwendung finden.
- ▶ Aufgrund der Multi-Helix (M-Helix) bei Schaftfräsern $\geq 3,0\text{mm } \phi$ werden Vibrationen zuverlässig verhindert und gleichzeitig der Schneidkantenverschleiß verringert.

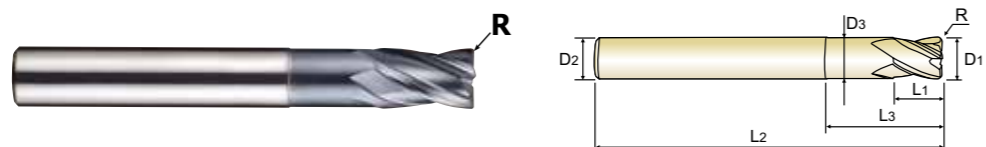

Flat Shank	Page	Plain Shank	Page
END MILL HOLDER	D118-137	HYDRAULIC CHUCK SHRINK FIT HOLDER	D15-46 D47-72
-	-	POWER MILLING CHUCK	D161-176
-	-	ER COLLET CHUCK SK SLIM CHUCK	D73-116 D183-201

Dϕ3, 30° HELIX

Unit : mm

EDP No.	Corner Radius	Mill Diameter	Shank Diameter	Length of Cut	Length Below Shank	Overall Length	Neck Diameter	Remark
	R	D1	D2	L1	L3	L2	D3	
★ SEME6406003090E	R0.3	6.0	6	15	30	90	5.85	Long Shank
SE5E640600524LE	R0.5	6.0	6	9	24	90	5.85	-
★ SEME6406005090E	R0.5	6.0	6	15	30	90	5.85	Long Shank
★ SEME6406010090E	R1.0	6.0	6	15	30	90	5.85	Long Shank
SEME6408001E	R0.1	8.0	8	12	25	70	7.70	Regular
★ SEME6408002E	R0.2	8.0	8	12	25	70	7.70	Regular
★ SEME6408003E	R0.3	8.0	8	12	25	70	7.70	Regular
★ SEME6408005E	R0.5	8.0	8	12	25	70	7.70	Regular
★ SEME6408010E	R1.0	8.0	8	12	25	70	7.70	Regular
SEME6408015E	R1.5	8.0	8	12	25	70	7.70	Regular
SEME6408020E	R2.0	8.0	8	12	25	70	7.70	Regular
SEME6408003100E	R0.3	8.0	8	20	35	100	7.70	Long Shank
★ SEME6408005100E	R0.5	8.0	8	20	35	100	7.70	Long Shank
★ SEME6408010100E	R1.0	8.0	8	20	35	100	7.70	Long Shank
SEME6410001E	R0.1	10.0	10	15	30	75	9.70	Regular
SEME6410002E	R0.2	10.0	10	15	30	75	9.70	Regular
SEME6410003E	R0.3	10.0	10	15	30	75	9.70	Regular
★ SEME6410005E	R0.5	10.0	10	15	30	75	9.70	Regular
★ SEME6410010E	R1.0	10.0	10	15	30	75	9.70	Regular
★ SEME6410015E	R1.5	10.0	10	15	30	75	9.70	Regular
SEME6410020E	R2.0	10.0	10	15	30	75	9.70	Regular
SEME6410003100E	R0.3	10.0	10	25	40	100	9.70	Long Shank
★ SEME6410005100E	R0.5	10.0	10	25	40	100	9.70	Long Shank
★ SEME6410010100E	R1.0	10.0	10	25	40	100	9.70	Long Shank

★ : Stock Item

▶ NEXT PAGE

Corner Radius Tolerance (mm)	Mill Dia. Tolerance (mm)	Shank Dia. Tolerance
± 0.02	0 ~ - 0.03	h5

◎ : Excellent ○ : Good

ISO Material Description	P										M						K			
	Non-alloy steel					Low alloy steel					High alloyed steel, and tool steel		Stainless steel				Grey cast iron		Nodular cast iron	Malleable cast iron
VDI 3323	1	2	3	4	5	6	7	8	9	10	11	12	13	14	15	16	17	18	19	20
HRc	13	25	28	32	38	42	48	52	58	62	68	72	78	82	88	92	98	102	108	112
HB	125	190	250	270	300	180	275	300	350	200	325	200	240	180	180	260	160	250	130	230
Recommend	◎	◎	◎	◎	◎	◎	◎	◎	◎	◎	◎	◎	◎	◎	◎	◎	◎	◎	◎	◎

CARBIDE, 4 FLUTE MULTIPLE HELIX CORNER RADIUS with EXTENDED NECK

● **VOLLHARTMETALL, 4 SCHNEIDEN MEHRSPIRAL ECKENRADIUS mit ABGESETZTEM SCHAFTTETL**
 (●) **Fraise carbure, 4 dents, torique, hélice multiple, détalonnée**
 (●) **MD, 4 TAGLIENTI, SCARICATA, TORICA**

- ▶ New coating and tool geometry applied resulting outstanding cutting abilities and wear resistance.
- ▶ Excellent performance when cutting prehardened steels, up to HRC55 which are used for molds & dies.
- ▶ Multiple Helix for 3.0mm and over 3.0mm diameter endmills minimizing vibration and decreasing wear in cutting.

- ▶ Aufgrund einer neuartigen Beschichtung und neuer Werkzeuggeometrien hervorragende Schnittleistung und Verschleißfestigkeit
- ▶ Hervorragende Leistung bei der Zerspaltung von vorvergüteten Stählen bis HRC55, welche im Werkzeug- und Formenbau Verwendung finden.
- ▶ Aufgrund der Multi-Helix (M-Helix) bei Schaftfräsern $\geq 3,0\text{mm } \phi$ werden Vibrationen zuverlässig verhindert und gleichzeitig der Schneidkantenverschleiß verringert.

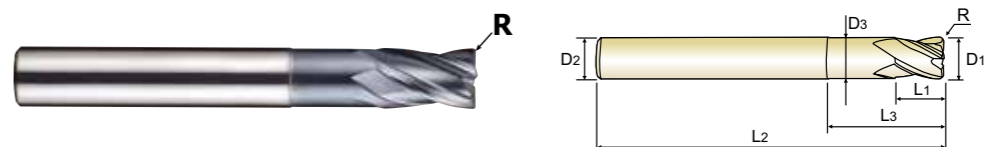

Flat Shank	Page	Plain Shank	Page
END MILL HOLDER	D118-137	HYDRAULIC CHUCK SHRINK FIT HOLDER	D15-46 D47-72
-	-	POWER MILLING CHUCK	D161-176
-	-	ER COLLET CHUCK SK SLIM CHUCK	D73-116 D183-201

Dϕ3, 30° HELIX

Unit : mm

EDP No.	Corner Radius	Mill Diameter	Shank Diameter	Length of Cut	Length Below Shank	Overall Length	Neck Diameter	Remark
	R	D1	D2	L1	L3	L2	D3	
SEME6412002E	R0.2	12.0	12	18	32	80	11.70	Regular
SEME6412003E	R0.3	12.0	12	18	32	80	11.70	Regular
★ SEME6412005E	R0.5	12.0	12	18	32	80	11.70	Regular
★ SEME6412010E	R1.0	12.0	12	18	32	80	11.70	Regular
★ SEME6412015E	R1.5	12.0	12	18	32	80	11.70	Regular
★ SEME6412020E	R2.0	12.0	12	18	32	80	11.70	Regular
SEME6412003110E	R0.3	12.0	12	30	50	110	11.70	Long Shank
★ SEME6412005110E	R0.5	12.0	12	30	50	110	11.70	Long Shank
★ SEME6412010110E	R1.0	12.0	12	30	50	110	11.70	Long Shank
★ SEME6416005E	R0.5	16.0	16	20	35	100	15.70	Regular
★ SEME6416010E	R1.0	16.0	16	20	35	100	15.70	Regular
SEME6416005150E	R0.5	16.0	16	35	50	150	15.70	Long Shank
SEME6416010150E	R1.0	16.0	16	35	50	150	15.70	Long Shank
★ SEME6420005E	R0.5	20.0	20	35	40	100	19.70	Regular
★ SEME6420010E	R1.0	20.0	20	35	40	100	19.70	Regular
SEME6420005150E	R0.5	20.0	20	35	55	150	19.70	Long Shank
SEME6420010150E	R1.0	20.0	20	35	55	150	19.70	Long Shank

★ : Stock Item

Corner Radius Tolerance (mm)	Mill Dia. Tolerance (mm)	Shank Dia. Tolerance
± 0.02	0 ~ - 0.03	h5

◎ : Excellent ○ : Good

ISO Material Description	P										M						K			
	Non-alloy steel					Low alloy steel					High alloyed steel, and tool steel		Stainless steel				Grey cast iron		Nodular cast iron	Malleable cast iron
VDI 3323	1	2	3	4	5	6	7	8	9	10	11	12	13	14	15	16	17	18	19	20
HRc	13	25	28	32	38	42	48	52	58	62	68	72	78	82	88	92	98	102	108	112
HB	125	190	250	270	300	180	275	300	350	200	325	200	240	180	180	260	160	250	130	230
Recommend	◎	◎	◎	◎	◎	◎	◎	◎	◎	◎	◎	◎	◎	◎	◎	◎	◎	◎	◎	◎



PLAIN SHANK SEME35 SERIES

CARBIDE, 2 FLUTE

- VOLLHARTMETALL, 2 SCHNEIDEN
- Fraise carbure, 2 dents
- MD, 2 TAGLIENTI, SPIGOLO VIVO

▶ New coating and tool geometry applied resulting outstanding cutting abilities and wear resistance.
 ▶ Excellent performance when cutting prehardened steels, up to HRC55 which are used for molds & dies.
 ▶ From a sharp edge geometry at the end tooth, cutting abilities at work process is increased.

▶ Aufgrund einer neuartigen Beschichtung und neuer Werkzeuggeometrien hervorragende Schnittleistung und Verschleißfestigkeit
 ▶ Hervorragende Leistung bei der Zerspanung von vorvergüteten Stählen bis HRC55, welche im Werkzeug- und Formenbau Verwendung finden.
 ▶ Aufgrund der scharfen Schneidengeometrie wird eine bessere Schnittfreudigkeit während der Bearbeitung gewährleistet.

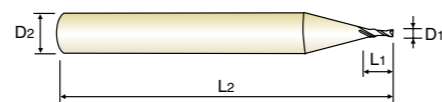

CARBIDE 2 30° PLAIN Coating p.C290-293

Flat Shank	Page	Plain Shank	Page
END MILL HOLDER	D118-137	HYDRAULIC CHUCK SHRINK FIT HOLDER	D15-46 D47-72
-	-	POWER MILLING CHUCK	D161-176
-	-	ER COLLET CHUCK SK SLIM CHUCK	D73-116 D183-201

Unit : mm

EDP No.	Mill Diameter	Shank Diameter	Length of Cut	Overall Length
	D1	D2	L1	L2
★ SEME35001E	0.1	4	0.2	40
★ SEME350015E	0.15	4	0.3	40
★ SEME35002E	0.2	4	0.4	40
SEMSE350025E	0.25	4	0.5	40
★ SEME35003E	0.3	4	0.6	40
SEMSE350035E	0.35	4	0.7	40
★ SEME35004E	0.4	4	0.8	40
SEMSE350045E	0.45	4	0.9	40
★ SEME35005E	0.5	4	1.0	40
SEMSE350055E	0.55	4	1.1	40
★ SEME35006E	0.6	4	1.2	40
SEMSE350065E	0.65	4	1.3	40
★ SEME35007E	0.7	4	1.4	40
SEMSE350075E	0.75	4	1.5	40
★ SEME35008E	0.8	4	1.6	40
SEMSE350085E	0.85	4	1.7	40
★ SEME35009E	0.9	4	1.8	40
SEMSE350095E	0.95	4	2	40
★ SEME35010E	1.0	6	2.5	50
★ SEME35012E	1.2	6	3	50
★ SEME35015E	1.5	6	4	50
★ SEME35020E	2.0	6	6	50
★ SEME35025E	2.5	6	7	50
★ SEME35030E	3.0	6	8	50

★ : Stock Item

▶ NEXT PAGE

Size	Mill Dia. Tolerance (mm)	Shank Dia. Tolerance
up to Ø6	0~ -0.012	h5
over Ø6	0~ -0.015	

◎ : Excellent ○ : Good

ISO Material Description	P										M						K					
	Non-alloy steel					Low alloy steel					High alloyed steel, and tool steel		Stainless steel				Grey cast iron		Nodular cast iron		Malleable cast iron	
VDI 3323	1	2	3	4	5	6	7	8	9	10	11	12	13	14	15	16	17	18	19	20		
HRc	13	25	28	32	35	38	40	42	45	48	50	52	55	58	60	62	65	68	70	72		
HB	125	190	250	270	300	300	350	350	350	350	200	240	180	180	180	260	160	250	130	230		
Recommend	○	○	◎	◎	◎	○	◎	◎	◎	◎	○	○	○	○	○	○	○	○	○	○		



PLAIN SHANK SEME35 SERIES

CARBIDE, 2 FLUTE

- VOLLHARTMETALL, 2 SCHNEIDEN
- Fraise carbure, 2 dents
- MD, 2 TAGLIENTI, SPIGOLO VIVO

▶ New coating and tool geometry applied resulting outstanding cutting abilities and wear resistance.
 ▶ Excellent performance when cutting prehardened steels, up to HRC55 which are used for molds & dies.
 ▶ From a sharp edge geometry at the end tooth, cutting abilities at work process is increased.

▶ Aufgrund einer neuartigen Beschichtung und neuer Werkzeuggeometrien hervorragende Schnittleistung und Verschleißfestigkeit
 ▶ Hervorragende Leistung bei der Zerspanung von vorvergüteten Stählen bis HRC55, welche im Werkzeug- und Formenbau Verwendung finden.
 ▶ Aufgrund der scharfen Schneidengeometrie wird eine bessere Schnittfreudigkeit während der Bearbeitung gewährleistet.

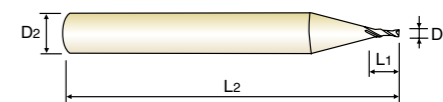

CARBIDE 2 30° PLAIN Coating p.C290-293

Flat Shank	Page	Plain Shank	Page
END MILL HOLDER	D118-137	HYDRAULIC CHUCK SHRINK FIT HOLDER	D15-46 D47-72
-	-	POWER MILLING CHUCK	D161-176
-	-	ER COLLET CHUCK SK SLIM CHUCK	D73-116 D183-201

Unit : mm

EDP No.	Mill Diameter	Shank Diameter	Length of Cut	Overall Length
	D1	D2	L1	L2
★ SEME35035E	3.5	6	10	50
★ SEME35040E	4.0	6	10	50
★ SEME35045E	4.5	6	14	50
★ SEME35050E	5.0	6	15	60
★ SEME35055E	5.5	6	15	60
★ SEME35060E	6.0	6	15	60
★ SEME35065E	6.5	8	18	60
★ SEME35070E	7.0	8	20	60
★ SEME35075E	7.5	8	20	60
★ SEME35080E	8.0	8	20	70
★ SEME35085E	8.5	10	22	70
★ SEME35090E	9.0	10	22	70
★ SEME35095E	9.5	10	24	70
★ SEME35100E	10.0	10	25	75
★ SEME35105E	10.5	12	26	75
★ SEME35110E	11.0	12	30	75
SEMSE35115E	11.5	12	30	80
★ SEME35120E	12.0	12	30	80
★ SEME35130E	13.0	12	35	100
SEMSE3514012SE	14.0	12	35	100
★ SEME3514014SE	14.0	14	35	100
★ SEME35140E	14.0	16	35	100
★ SEME35150E	15.0	16	38	100
★ SEME35160E	16.0	16	40	100

★ : Stock Item

▶ NEXT PAGE

Size	Mill Dia. Tolerance (mm)	Shank Dia. Tolerance
up to Ø6	0~ -0.012	h5
over Ø6	0~ -0.015	

◎ : Excellent ○ : Good

ISO Material Description	P										M						K					
	Non-alloy steel					Low alloy steel					High alloyed steel, and tool steel		Stainless steel				Grey cast iron		Nodular cast iron		Malleable cast iron	
VDI 3323	1	2	3	4	5	6	7	8	9	10	11	12	13	14	15	16	17	18	19	20		
HRc	13	25	28	32	35	38	40	42	45	48	50	52	55	58	60	62	65	68	70	72		
HB	125	190	250	270	300	300	350	350	350	350	200	240	180	180	180	260	160	250	130	230		
Recommend	○	○	◎	◎	◎	○	◎	◎	◎	◎	○	○	○	○	○	○	○	○	○	○		

CARBIDE, 2 FLUTE

- VOLLHARTMETALL, 2 SCHNEIDEN
- () Fraise carbure, 2 dents
- () MD, 2 TAGLIENTI, SPIGOLO VIVO

▶ New coating and tool geometry applied resulting outstanding cutting abilities and wear resistance.
 ▶ Excellent performance when cutting prehardened steels, up to HRC55 which are used for molds & dies.
 ▶ From a sharp edge geometry at the end tooth, cutting abilities at work process is increased.

▶ Aufgrund einer neuartigen Beschichtung und neuer Werkzeuggeometrien hervorragende Schnittleistung und Verschleißfestigkeit
 ▶ Hervorragende Leistung bei der Zerspaltung von vorvergüteten Stählen bis HRC55, welche im Werkzeug- und Formenbau Verwendung finden.
 ▶ Aufgrund der scharfen Schneidengeometrie wird eine bessere Schnittfreudigkeit während der Bearbeitung gewährleistet.

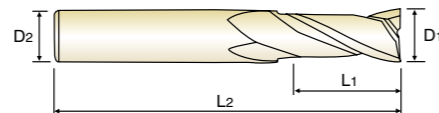

CARBIDE 2 30° PLAIN Coating p.C290-293

Flat Shank	Page	Plain Shank	Page
END MILL HOLDER	D118-137	HYDRAULIC CHUCK SHRINK FIT HOLDER	D15-46 D47-72
-	-	POWER MILLING CHUCK	D161-176
-	-	ER COLLET CHUCK SK SLIM CHUCK	D73-116 D183-201

Unit : mm

EDP No.	Mill Diameter	Shank Diameter	Length of Cut	Overall Length
	D1	D2	L1	L2
SEME35170E	17.0	16	42	100
★ SEME35180E	18.0	16	45	100
SEME3518018SE	18.0	18	45	100
SEME35190E	19.0	20	45	100
★ SEME35200E	20.0	20	45	100
SEME35210E	21.0	20	45	100
SEME35220E	22.0	20	45	100
SEME35230E	23.0	25	50	120
SEME35240E	24.0	25	50	120
SEME35250E	25.0	25	50	120

★ : Stock Item

Size	Mill Dia. Tolerance (mm)	Shank Dia. Tolerance
up to Ø6	0~ - 0.012	h5
over Ø6	0~ - 0.015	

◎ : Excellent ○ : Good

ISO Material Description	P										M				K						
	Non-alloy steel					Low alloy steel					High alloyed steel, and tool steel		Stainless steel		Grey cast iron		Nodular cast iron		Malleable cast iron		
VDI 3323	1	2	3	4	5	6	7	8	9	10	11	12	13	14	15	16	17	18	19	20	
HRc	13	25	28	32	35	10	29	32	38	15	35	15	23	10	10	26	3	25	21	21	
HB	125	190	250	270	300	180	275	300	350	200	325	200	240	180	180	260	160	250	130	230	
Recommend	○	○	◎	◎	◎	○	◎	◎	◎	◎	◎	○	○	○	○	○	○	○	○	○	○

ISO Material Description	N										S				H						
	Aluminum-wrought alloy		Aluminum-cast, alloyed		Copper and Copper Alloys (Bronze / Brass)		Non Metallic Materials		Heat Resistant Super Alloys				Titanium Alloys		Hardened steel	Chilled Cast Iron	Hardened Cast Iron				
VDI 3323	21	22	23	24	25	26	27	28	29	30	31	32	33	34	35	36	37	38	39	40	41
HRc	21	22	23	24	25	26	27	28	29	30	31	32	33	34	35	36	37	38	39	40	41
HB	60	100	75	90	130	110	90	100			200	280	250	350	320	400 Rm	1050 Rm	550	630	400	550
Recommend																		○	◎	○	○

CARBIDE, 2 FLUTE (0.1mm a Unit / 4mm Shank)

- VOLLHARTMETALL, 2 SCHNEIDEN
- () Fraise carbure, 2 dents (par 0.1mm / Ø queue 4mm)
- () MD, 2 TAGLIENTI, SPIGOLO VIVO (gambo 4 mm)

▶ New coating and tool geometry applied resulting outstanding cutting abilities and wear resistance.
 ▶ Excellent performance when cutting prehardened steels, up to HRC55 which are used for molds & dies.
 ▶ From a sharp edge geometry at the end tooth, cutting abilities at work process is increased.

▶ Aufgrund einer neuartigen Beschichtung und neuer Werkzeuggeometrien hervorragende Schnittleistung und Verschleißfestigkeit
 ▶ Hervorragende Leistung bei der Zerspaltung von vorvergüteten Stählen bis HRC55, welche im Werkzeug- und Formenbau Verwendung finden.
 ▶ Aufgrund der scharfen Schneidengeometrie wird eine bessere Schnittfreudigkeit während der Bearbeitung gewährleistet.

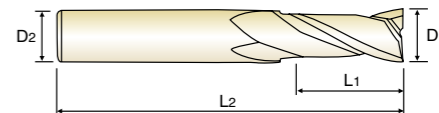

CARBIDE 2 30° PLAIN Coating p.C290-293

Flat Shank	Page	Plain Shank	Page
END MILL HOLDER	D118-137	HYDRAULIC CHUCK SHRINK FIT HOLDER	D15-46 D47-72
-	-	POWER MILLING CHUCK	D161-176
-	-	ER COLLET CHUCK SK SLIM CHUCK	D73-116 D183-201

Unit : mm

EDP No.	Mill Diameter	Shank Diameter	Length of Cut	Overall Length
	D1	D2	L1	L2
★ SEME350104SE	1.0	4	2.5	50
★ SEME350114SE	1.1	4	3	50
★ SEME350124SE	1.2	4	3	50
★ SEME350134SE	1.3	4	3	50
★ SEME350144SE	1.4	4	4	50
★ SEME350154SE	1.5	4	4	50
★ SEME350164SE	1.6	4	4	50
★ SEME350174SE	1.7	4	4	50
★ SEME350184SE	1.8	4	5	50
★ SEME350194SE	1.9	4	5	50
★ SEME350204SE	2.0	4	6	50
SEME350214SE	2.1	4	6	50
★ SEME350224SE	2.2	4	6	50
★ SEME350234SE	2.3	4	6	50
★ SEME350244SE	2.4	4	6	50
★ SEME350254SE	2.5	4	8	50
★ SEME350264SE	2.6	4	8	50
★ SEME350274SE	2.7	4	8	50
★ SEME350284SE	2.8	4	8	50
SEME350294SE	2.9	4	8	50
★ SEME350304SE	3.0	4	8	50
SEME350354SE	3.5	4	10	50
★ SEME350404SE	4.0	4	10	50
★ SEME350404S080E	4.0	4	10	80

★ : Stock Item

Mill Dia. Tolerance (mm)	Shank Dia. Tolerance
0~ - 0.012	h5

◎ : Excellent ○ : Good

ISO Material Description	P										M				K						
	Non-alloy steel					Low alloy steel					High alloyed steel, and tool steel		Stainless steel		Grey cast iron		Nodular cast iron		Malleable cast iron		
VDI 3323	1	2	3	4	5	6	7	8	9	10	11	12	13	14	15	16	17	18	19	20	
HRc	13	25	28	32	35	10	29	32	38	15	35	15	23	10	10	26	3	25	21	21	
HB	125	190	250	270	300	180	275	300	350	200	325	200	240	180	180	260	160	250	130	230	
Recommend	○	○	◎	◎	◎	○	◎	◎	◎	◎	◎	○	○	○	○	○	○	○	○	○	○

ISO Material Description	N										S				H						
	Aluminum-wrought alloy		Aluminum-cast, alloyed		Copper and Copper Alloys (Bronze / Brass)		Non Metallic Materials		Heat Resistant Super Alloys				Titanium Alloys		Hardened steel	Chilled Cast Iron	Hardened Cast Iron				
VDI 3323	21	22	23	24	25	26	27	28	29	30	31	32	33	34	35	36	37	38	39	40	41
HRc	21	22	23	24	25	26	27	28	29	30	31	32	33	34	35	36	37	38	39	40	41
HB	60	100	75	90	130	110	90	100			200	280	250	350	320	400 Rm	1050 Rm	550	630	400	550
Recommend																		○	◎	○	○



PLAIN SHANK SEME35 SERIES

CARBIDE, 2 FLUTE (3mm Shank)

- VOLLHARTMETALL, 2 SCHNEIDEN
- Fraise carbure, 2 dents (Ø queue 3 mm)
- MD, 2 TAGLIENTI, SPIGOLO VIVO (gambo 3mm)

▶ New coating and tool geometry applied resulting outstanding cutting abilities and wear resistance.
 ▶ Excellent performance when cutting prehardened steels, up to HRC55 which are used for molds & dies.
 ▶ From a sharp edge geometry at the end tooth, cutting abilities at work process is increased.

▶ Aufgrund einer neuartigen Beschichtung und neuer Werkzeuggeometrien hervorragende Schnittleistung und Verschleißfestigkeit
 ▶ Hervorragende Leistung bei der Zerspaltung von vorvergüteten Stählen bis HRC55, welche im Werkzeug- und Formenbau Verwendung finden.
 ▶ Aufgrund der scharfen Schneidengeometrie wird eine bessere Schnittfreudigkeit während der Bearbeitung gewährleistet.

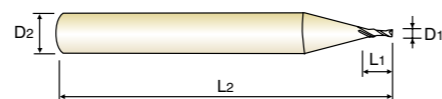

CARBIDE 2 30° PLAIN Coating p.C290-293

Flat Shank	Page	Plain Shank	Page
END MILL HOLDER	D118-137	HYDRAULIC CHUCK SHRINK FIT HOLDER	D15-46 D47-72
-	-	POWER MILLING CHUCK	D161-176
-	-	ER COLLET CHUCK SK SLIM CHUCK	D73-116 D183-201

Unit : mm

EDP No.	Mill Diameter	Shank Diameter	Length of Cut	Overall Length	
				L1	L2
★ SEME350013SE	0.1	3	0.2		40
★ SEME350023SE	0.2	3	0.4		40
★ SEME350033SE	0.3	3	0.6		40
★ SEME350043SE	0.4	3	0.8		40
★ SEME350053SE	0.5	3	1.0		40
★ SEME350063SE	0.6	3	1.2		40
★ SEME350073SE	0.7	3	1.4		40
★ SEME350083SE	0.8	3	1.6		40
★ SEME350093SE	0.9	3	1.8		40
★ SEME350103SE	1.0	3	2.5		50
★ SEME350123SE	1.2	3	3		50
★ SEME350153SE	1.5	3	4		50
★ SEME350203SE	2.0	3	6		50
★ SEME350253SE	2.5	3	7		50
★ SEME350303SE	3.0	3	8		50

★ : Stock Item

Mill Dia. Tolerance (mm)	Shank Dia. Tolerance
0~ - 0.012	h5

◎ : Excellent ○ : Good

ISO Material Description	P										M				K					
	Non-alloy steel					Low alloy steel					High alloyed steel, and tool steel		Stainless steel		Grey cast iron		Nodular cast iron		Malleable cast iron	
VDI 3323	1	2	3	4	5	6	7	8	9	10	11	12	13	14	15	16	17	18	19	20
HRc	13	25	28	32	38	10	29	32	38	45	15	35	40	48	15	26	3	25	10	21
HB	125	190	250	270	300	180	275	300	350	400	200	240	180	260	160	250	130	230		
Recommend	○	○	◎	◎	◎	○	◎	◎	◎	◎	○	○	○	○	○	○	○	○	○	○

ISO Material Description	N										S				H						
	Aluminum-wrought alloy		Aluminum-cast, alloyed		Copper and Copper Alloys (Bronze / Brass)		Non Metallic Materials		Heat Resistant Super Alloys				Titanium Alloys		Hardened steel	Chilled Cast Iron	Hardened Cast Iron				
VDI 3323	21	22	23	24	25	26	27	28	29	30	31	32	33	34	35	36	37	38	39	40	41
HRc	21	22	23	24	25	26	27	28	29	30	31	32	33	34	35	36	37	38	39	40	41
HB	60	100	75	90	130	110	90	100			200	280	250	350	320	400 Rm	1050 Rm	550	630	400	550
Recommend																		○	◎	○	○



PLAIN SHANK SEME70 SERIES

CARBIDE, 2 FLUTE LONG LENGTH

- VOLLHARTMETALL, 2 SCHNEIDEN LANG
- Fraise carbure, 2 dents, longue
- MD, 2 TAGLIENTI, SPIGOLO VIVO, SERIE LUNGA

▶ New coating and tool geometry applied resulting outstanding cutting abilities and wear resistance.
 ▶ Excellent performance when cutting prehardened steels, up to HRC55 which are used for molds & dies.
 ▶ Available in various lengths of cut and also overall lengths.

▶ Aufgrund einer neuartigen Beschichtung und neuer Werkzeuggeometrien hervorragende Schnittleistung und Verschleißfestigkeit
 ▶ Hervorragende Leistung bei der Zerspaltung von vorvergüteten Stählen bis HRC55, welche im Werkzeug- und Formenbau Verwendung finden.
 ▶ Erhältlich in verschiebenen Schneiden- und Gesamtlängen.

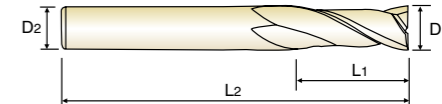

CARBIDE 2 30° PLAIN Coating p.C294-299

Flat Shank	Page	Plain Shank	Page
END MILL HOLDER	D118-137	HYDRAULIC CHUCK SHRINK FIT HOLDER	D15-46 D47-72
-	-	POWER MILLING CHUCK	D161-176
-	-	ER COLLET CHUCK SK SLIM CHUCK	D73-116 D183-201

Unit : mm

EDP No.	Mill Diameter	Shank Diameter	Length of Cut	Overall Length	
				L1	L2
★ SEME7001003E	1.0	6	3		60
★ SEME7001004E	1.0	6	4		60
SEM7001005E	1.0	6	5		60
★ SEME7001006E	1.0	6	6		60
SEM7001007E	1.0	6	7		60
★ SEME7001008E	1.0	6	8		60
★ SEME7001010E	1.0	6	10		60
SEM7001012E	1.0	6	12		60
SEM7001204E	1.2	6	4		60
SEM7001206E	1.2	6	6		60
SEM7001208E	1.2	6	8		60
SEM7001210E	1.2	6	10		60
SEM7001212E	1.2	6	12		60
★ SEME7001506E	1.5	6	6		60
★ SEME7001508E	1.5	6	8		60
★ SEME7001510E	1.5	6	10		60
★ SEME7001512E	1.5	6	12		60
SEM7001514E	1.5	6	14		60
★ SEME7001516E	1.5	6	16		60
★ SEME7002008E	2.0	6	8		60
★ SEME7002010E	2.0	6	10		60
★ SEME7002012E	2.0	6	12		60
SEM7002014E	2.0	6	14		60
★ SEME7002016E	2.0	6	16		60

★ : Stock Item

Mill Dia. Tolerance (mm)	Shank Dia. Tolerance
0 ~ - 0.03	h5

◎ : Excellent ○ : Good

ISO Material Description	P										M				K					
	Non-alloy steel					Low alloy steel					High alloyed steel, and tool steel		Stainless steel		Grey cast iron		Nodular cast iron		Malleable cast iron	
VDI 3323	1	2	3	4	5	6	7	8	9	10	11	12	13	14	15	16	17	18	19	20
HRc	13	25	28	32	38	10	29	32	38	45	15	35	40	48	15	26	3	25	10	21
HB	125	190	250	270	300	180	275	300	350	400	200	240	180	260	160	250	130	230		
Recommend	○	○	◎	◎	◎	○	◎	◎	◎	◎	○	○	○	○	○	○	○	○	○	○

ISO Material Description	N										S				H						
	Aluminum-wrought alloy		Aluminum-cast, alloyed		Copper and Copper Alloys (Bronze / Brass)		Non Metallic Materials		Heat Resistant Super Alloys				Titanium Alloys		Hardened steel	Chilled Cast Iron	Hardened Cast Iron				
VDI 3323	21	22	23	24	25	26	27	28	29	30	31	32	33	34	35	36	37	38	39	40	41
HRc	21	22	23	24	25	26	27	28	29	30	31	32	33	34	35	36	37	38	39	40	41
HB	60	100	75	90	130	110	90	100			200	280	250	350	320	400 Rm	1050 Rm	550	630	400	550
Recommend																		○	◎	○	○

CARBIDE, 2 FLUTE LONG LENGTH

VOLLHARTMETALL, 2 SCHNEIDEN LANG
 () Fraise carbure, 2 dents, longue
 () MD, 2 TAGLIENTI, SPIGOLO VIVO, SERIE LUNGA

▶ New coating and tool geometry applied resulting outstanding cutting abilities and wear resistance.
 ▶ Excellent performance when cutting prehardened steels, up to HRC55 which are used for molds & dies.
 ▶ Available in various lengths of cut and also overall lengths.

▶ Aufgrund einer neuartigen Beschichtung und neuer Werkzeuggeometrien hervorragende Schnittleistung und Verschleißfestigkeit
 ▶ Hervorragende Leistung bei der Zerspaltung von vorvergüteten Stählen bis HRC55, welche im Werkzeug- und Formenbau Verwendung finden.
 ▶ Erhältlich in verschiebenen Schneiden- und Gesamtlängen.

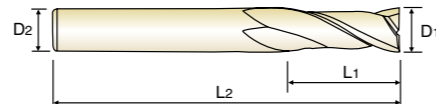

CARBIDE 2 30° PLAIN Coating p.C294-299

Flat Shank	Page	Plain Shank	Page
END MILL HOLDER	D118-137	HYDRAULIC CHUCK SHRINK FIT HOLDER	D15-46 D47-72
-	-	POWER MILLING CHUCK	D161-176
-	-	ER COLLET CHUCK SK SLIM CHUCK	D73-116 D183-201

Unit : mm

EDP No.	Mill Diameter	Shank Diameter	Length of Cut	Overall Length
	D1	D2	L1	L2
★ SEME7002510E	2.5	6	10	60
SEME7002512E	2.5	6	12	60
★ SEME7002516E	2.5	6	16	60
SEME7002520E	2.5	6	20	60
SEME7002526E	2.5	6	26	60
SEME70030163SE	3.0	3	16	100
★ SEME7003010E	3.0	6	10	70
★ SEME7003012E	3.0	6	12	70
★ SEME7003014E	3.0	6	14	70
★ SEME7003016E	3.0	6	16	70
★ SEME7003020E	3.0	6	20	70
★ SEME7003026E	3.0	6	26	70
SEME7003030E	3.0	6	30	70
SEME70040204SE	4.0	4	20	100
★ SEME7004012E	4.0	6	12	70
★ SEME7004016E	4.0	6	16	70
★ SEME7004020E	4.0	6	20	70
★ SEME7004026E	4.0	6	26	70
★ SEME7004030E	4.0	6	30	70
★ SEME7005020E	5.0	6	20	70
★ SEME7005025E	5.0	6	25	70
SEME7005025100E	5.0	6	25	100
★ SEME7005030E	5.0	6	30	80
SEME7005035E	5.0	6	35	90

★ : Stock Item ▶ NEXT PAGE

Mill Dia. Tolerance (mm)	Shank Dia. Tolerance
0 ~ - 0.03	h5

◎ : Excellent ○ : Good

ISO Material Description	P										M				K						
	Non-alloy steel					Low alloy steel					High alloyed steel, and tool steel		Stainless steel		Grey cast iron		Nodular cast iron		Malleable cast iron		
VDI 3323	1	2	3	4	5	6	7	8	9	10	11	12	13	14	15	16	17	18	19	20	
HRc	13	25	28	32	30	10	29	32	38	15	35	15	23	10	10	26	3	25	21	21	
HB	125	190	250	270	300	180	275	300	350	200	325	200	240	180	180	260	160	250	130	230	
Recommend	○	○	◎	◎	◎	○	◎	◎	◎	◎	◎	○	○	○	○	○	○	○	○	○	○

ISO Material Description	N										S				H						
	Aluminum-wrought alloy		Aluminum-cast, alloyed		Copper and Copper Alloys (Bronze / Brass)		Non Metallic Materials		Heat Resistant Super Alloys				Titanium Alloys		Hardened steel	Chilled Cast Iron	Hardened Cast Iron				
VDI 3323	21	22	23	24	25	26	27	28	29	30	31	32	33	34	35	36	37	38	39	40	41
HRc	15	30	25	38	34						15	30	25	38	34			55	60	42	55
HB	60	100	75	90	130	110	90	100			200	280	250	350	320	400 Rm	1050 Rm	550	630	400	550
Recommend											○	○	○	○	○	○	○	○	◎	○	○

CARBIDE, 2 FLUTE LONG LENGTH

VOLLHARTMETALL, 2 SCHNEIDEN LANG
 () Fraise carbure, 2 dents, longue
 () MD, 2 TAGLIENTI, SPIGOLO VIVO, SERIE LUNGA

▶ New coating and tool geometry applied resulting outstanding cutting abilities and wear resistance.
 ▶ Excellent performance when cutting prehardened steels, up to HRC55 which are used for molds & dies.
 ▶ Available in various lengths of cut and also overall lengths.

▶ Aufgrund einer neuartigen Beschichtung und neuer Werkzeuggeometrien hervorragende Schnittleistung und Verschleißfestigkeit
 ▶ Hervorragende Leistung bei der Zerspaltung von vorvergüteten Stählen bis HRC55, welche im Werkzeug- und Formenbau Verwendung finden.
 ▶ Erhältlich in verschiebenen Schneiden- und Gesamtlängen.

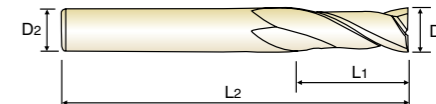

CARBIDE 2 30° PLAIN Coating p.C294-299

Flat Shank	Page	Plain Shank	Page
END MILL HOLDER	D118-137	HYDRAULIC CHUCK SHRINK FIT HOLDER	D15-46 D47-72
-	-	POWER MILLING CHUCK	D161-176
-	-	ER COLLET CHUCK SK SLIM CHUCK	D73-116 D183-201

Unit : mm

EDP No.	Mill Diameter	Shank Diameter	Length of Cut	Overall Length
	D1	D2	L1	L2
★ SEME7005040E	5.0	6	40	100
★ SEME7006015E	6.0	6	15	60
★ SEME7006015080E	6.0	6	15	80
★ SEME7006020E	6.0	6	20	70
★ SEME7006020090E	6.0	6	20	90
★ SEME7006025E	6.0	6	25	75
★ SEME7006030E	6.0	6	30	80
★ SEME7006030100E	6.0	6	30	100
★ SEME7006030150E	6.0	6	30	150
★ SEME7006035E	6.0	6	35	90
★ SEME7006040E	6.0	6	40	90
★ SEME7006040120E	6.0	6	40	120
★ SEME7006045E	6.0	6	45	150
★ SEME7008025E	8.0	8	25	80
★ SEME7008030E	8.0	8	30	80
★ SEME7008030100E	8.0	8	30	100
★ SEME7008035E	8.0	8	35	90
★ SEME7008040E	8.0	8	40	90
★ SEME7008040120E	8.0	8	40	120
SEME7008040150E	8.0	8	40	150
★ SEME7008045E	8.0	8	45	100
★ SEME7008050E	8.0	8	50	100
SEME7008050150E	8.0	8	50	150
★ SEME7010030E	10.0	10	30	80

★ : Stock Item ▶ NEXT PAGE

Mill Dia. Tolerance (mm)	Shank Dia. Tolerance
0 ~ - 0.03	h5

◎ : Excellent ○ : Good

ISO Material Description	P										M				K						
	Non-alloy steel					Low alloy steel					High alloyed steel, and tool steel		Stainless steel		Grey cast iron		Nodular cast iron		Malleable cast iron		
VDI 3323	1	2	3	4	5	6	7	8	9	10	11	12	13	14	15	16	17	18	19	20	
HRc	13	25	28	32	30	10	29	32	38	15	35	15	23	10	10	26	3	25	21	21	
HB	125	190	250	270	300	180	275	300	350	200	325	200	240	180	180	260	160	250	130	230	
Recommend	○	○	◎	◎	◎	○	◎	◎	◎	◎	◎	○	○	○	○	○	○	○	○	○	○

ISO Material Description	N										S				H						
	Aluminum-wrought alloy		Aluminum-cast, alloyed		Copper and Copper Alloys (Bronze / Brass)		Non Metallic Materials		Heat Resistant Super Alloys				Titanium Alloys		Hardened steel	Chilled Cast Iron	Hardened Cast Iron				
VDI 3323	21	22	23	24	25	26	27	28	29	30	31	32	33	34	35	36	37	38	39	40	41
HRc	15	30	25	38	34						15	30	25	38	34			55	60	42	55
HB	60	100	75	90	130	110	90	100			200	280	250	350	320	400 Rm	1050 Rm	550	630	400	550
Recommend											○	○	○	○	○	○	○	○	◎	○	○

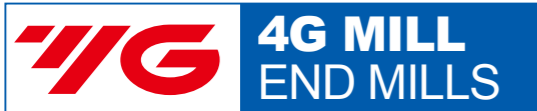

PLAIN SHANK SEME70 SERIES

CARBIDE, 2 FLUTE LONG LENGTH

● VOLLHARTMETALL, 2 SCHNEIDEN LANG
 () Fraise carbure, 2 dents, longue
 () MD, 2 TAGLIENTI, SPIGOLO VIVO, SERIE LUNGA

▶ New coating and tool geometry applied resulting outstanding cutting abilities and wear resistance.
 ▶ Excellent performance when cutting prehardened steels, up to HRC55 which are used for molds & dies.
 ▶ Available in various lengths of cut and also overall lengths.

▶ Aufgrund einer neuartigen Beschichtung und neuer Werkzeuggeometrien hervorragende Schnittleistung und Verschleißfestigkeit
 ▶ Hervorragende Leistung bei der Zerspaltung von vorvergüteten Stählen bis HRC55, welche im Werkzeug- und Formenbau Verwendung finden.
 ▶ Erhältlich in verschiebenen Schneiden- und Gesamtlängen.

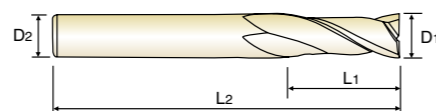

CARBIDE 2 30° PLAIN Coating Y p.C294-299

Flat Shank	Page	Plain Shank	Page
END MILL HOLDER	D118-137	HYDRAULIC CHUCK SHRINK FIT HOLDER	D15-46 D47-72
-	-	POWER MILLING CHUCK	D161-176
-	-	ER COLLET CHUCK SK SLIM CHUCK	D73-116 D183-201

Unit : mm

EDP No.	Mill Diameter	Shank Diameter	Length of Cut	Overall Length
	D1	D2	L1	L2
★ SEME7010030100E	10.0	10	30	100
★ SEME7010035E	10.0	10	35	90
★ SEME7010040E	10.0	10	40	90
★ SEME7010040120E	10.0	10	40	120
★ SEME7010045E	10.0	10	45	100
★ SEME7010050E	10.0	10	50	100
★ SEME7010050150E	10.0	10	50	150
SEME7010050200E	10.0	10	50	200
★ SEME7010055E	10.0	10	55	150
★ SEME7010060E	10.0	10	60	110
SEME7010060200E	10.0	10	60	200
★ SEME7012035E	12.0	12	35	90
★ SEME7012040E	12.0	12	40	100
★ SEME7012040120E	12.0	12	40	120
★ SEME7012045E	12.0	12	45	130
★ SEME7012050E	12.0	12	50	100
★ SEME7012050150E	12.0	12	50	150
★ SEME7012055E	12.0	12	55	110
★ SEME7012060E	12.0	12	60	110
★ SEME7012060150E	12.0	12	60	150
SEME7012060200E	12.0	12	60	200
SEME7012065E	12.0	12	65	150
SEME7012070E	12.0	12	70	120
SEME7012070200E	12.0	12	70	200

★ : Stock Item ▶ NEXT PAGE

Mill Dia. Tolerance (mm)	Shank Dia. Tolerance
0 ~ - 0.03	h5

◎ : Excellent ○ : Good

ISO Material Description	P										M				K					
	Non-alloy steel					Low alloy steel					High alloyed steel, and tool steel		Stainless steel		Grey cast iron		Nodular cast iron		Malleable cast iron	
VDI 3323	1	2	3	4	5	6	7	8	9	10	11	12	13	14	15	16	17	18	19	20
HRc	13	25	28	32	30	29	32	38	35	35	15	23	10	10	10	26	3	25	21	21
HB	125	190	250	270	300	180	275	300	350	200	325	200	240	180	180	260	160	250	130	230
Recommend	○	○	◎	◎	◎	○	◎	◎	◎	◎	○	○	○	○	○	○	○	○	○	○

ISO Material Description	N										S				H						
	Aluminum-wrought alloy		Aluminum-cast, alloyed			Copper and Copper Alloys (Bronze / Brass)			Non Metallic Materials		Heat Resistant Super Alloys				Titanium Alloys		Hardened steel		Chilled Cast Iron		Hardened Cast Iron
VDI 3323	21	22	23	24	25	26	27	28	29	30	31	32	33	34	35	36	37	38	39	40	41
HRc	15	30	25	38	34	200	280	250	350	320	400 Rm	1050 Rm	550	630	400	550	○	◎	◎	○	
HB	60	100	75	90	130	110	90	100													
Recommend																					



PLAIN SHANK SEME70 SERIES

CARBIDE, 2 FLUTE LONG LENGTH

● VOLLHARTMETALL, 2 SCHNEIDEN LANG
 () Fraise carbure, 2 dents, longue
 () MD, 2 TAGLIENTI, SPIGOLO VIVO, SERIE LUNGA

▶ New coating and tool geometry applied resulting outstanding cutting abilities and wear resistance.
 ▶ Excellent performance when cutting prehardened steels, up to HRC55 which are used for molds & dies.
 ▶ Available in various lengths of cut and also overall lengths.

▶ Aufgrund einer neuartigen Beschichtung und neuer Werkzeuggeometrien hervorragende Schnittleistung und Verschleißfestigkeit
 ▶ Hervorragende Leistung bei der Zerspaltung von vorvergüteten Stählen bis HRC55, welche im Werkzeug- und Formenbau Verwendung finden.
 ▶ Erhältlich in verschiebenen Schneiden- und Gesamtlängen.

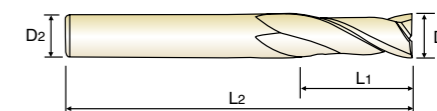

CARBIDE 2 30° PLAIN Coating Y p.C294-299

Flat Shank	Page	Plain Shank	Page
END MILL HOLDER	D118-137	HYDRAULIC CHUCK SHRINK FIT HOLDER	D15-46 D47-72
-	-	POWER MILLING CHUCK	D161-176
-	-	ER COLLET CHUCK SK SLIM CHUCK	D73-116 D183-201

Unit : mm

EDP No.	Mill Diameter	Shank Diameter	Length of Cut	Overall Length
	D1	D2	L1	L2
SEME7014050E	14.0	16	50	110
★ SEME7014060E	14.0	16	60	150
★ SEME7016040E	16.0	16	40	150
SEME7016050E	16.0	16	50	110
SEME7016050150E	16.0	16	50	150
SEME7016060E	16.0	16	60	120
SEME7016070E	16.0	16	70	130
★ SEME7016070150E	16.0	16	70	150
SEME7016070200E	16.0	16	70	200
SEME7016080E	16.0	16	80	150
SEME7016090E	16.0	16	90	150
SEME70160110E	16.0	16	110	200
SEME70160120E	16.0	16	120	250
SEME7018050E	18.0	20	50	120
SEME7018070E	18.0	20	70	130
SEME70180100E	18.0	20	100	200
SEME7020050E	20.0	20	50	110
SEME7020050150E	20.0	20	50	150
SEME7020060E	20.0	20	60	130
SEME7020070E	20.0	20	70	130
SEME7020080E	20.0	20	80	150
SEME7020090E	20.0	20	90	150
★ SEME7020090200E	20.0	20	90	200
★ SEME70200110E	20.0	20	110	200

★ : Stock Item ▶ NEXT PAGE

Mill Dia. Tolerance (mm)	Shank Dia. Tolerance
0 ~ - 0.03	h5

◎ : Excellent ○ : Good

ISO Material Description	P										M				K					
	Non-alloy steel					Low alloy steel					High alloyed steel, and tool steel		Stainless steel		Grey cast iron		Nodular cast iron		Malleable cast iron	
VDI 3323	1	2	3	4	5	6	7	8	9	10	11	12	13	14	15	16	17	18	19	20
HRc	13	25	28	32	30	29	32	38	35	35	15	23	10	10	10	26	3	25	21	21
HB	125	190	250	270	300	180	275	300	350	200	325	200	240	180	180	260	160	250	130	230
Recommend	○	○	◎	◎	◎	○	◎	◎	◎	◎	○	○	○	○	○	○	○	○	○	○

ISO Material Description	N										S				H						
	Aluminum-wrought alloy		Aluminum-cast, alloyed			Copper and Copper Alloys (Bronze / Brass)			Non Metallic Materials		Heat Resistant Super Alloys				Titanium Alloys		Hardened steel		Chilled Cast Iron		Hardened Cast Iron
VDI 3323	21	22	23	24	25	26	27	28	29	30	31	32	33	34	35	36	37	38	39	40	41
HRc	15	30	25	38	34	200	280	250	350	320	400 Rm	1050 Rm	550	630	400	550	○	◎	◎	○	
HB	60	100	75	90	130	110	90	100													
Recommend																					

CARBIDE, 2 FLUTE LONG LENGTH

- VOLLHARTMETALL, 2 SCHNEIDEN LANG
- Fraise carbure, 2 dents, longue
- MD, 2 TAGLIENTI, SPIGOLO VIVO, SERIE LUNGA

- ▶ New coating and tool geometry applied resulting outstanding cutting abilities and wear resistance.
- ▶ Excellent performance when cutting prehardened steels, up to HRC55 which are used for molds & dies.
- ▶ Available in various lengths of cut and also overall lengths.

- ▶ Aufgrund einer neuartigen Beschichtung und neuer Werkzeuggeometrien hervorragende Schnittleistung und Verschleißfestigkeit
- ▶ Hervorragende Leistung bei der Zerspaltung von vorvergüteten Stählen bis HRC55, welche im Werkzeug- und Formenbau Verwendung finden.
- ▶ Erhältlich in verschiebenen Schneiden- und Gesamtlängen.

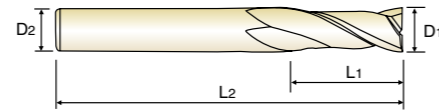

CARBIDE
2
30°
PLAIN
Coating
Y
p.C294-299

Flat Shank	Page	Plain Shank	Page
END MILL HOLDER	D118-137	HYDRAULIC CHUCK SHRINK FIT HOLDER	D15-46 D47-72
-	-	POWER MILLING CHUCK	D161-176
-	-	ER COLLET CHUCK SK SLIM CHUCK	D73-116 D183-201

Unit : mm

EDP No.	Mill Diameter	Shank Diameter	Length of Cut	Overall Length
	D1	D2	L1	L2
SEME70200120E	20.0	20	120	250
SEME7022075E	22.0	20	75	150
SEME70220110E	22.0	20	110	200
SEME7025070E	25.0	25	70	150
SEME7025090E	25.0	25	90	150
SEME70250110E	25.0	25	110	200
SEME70250120E	25.0	25	120	250

★ : Stock Item

Mill Dia. Tolerance (mm)	Shank Dia. Tolerance
0 ~ - 0.03	h5

◎ : Excellent ○ : Good

ISO Material Description	P										M				K						
	Non-alloy steel					Low alloy steel					High alloyed steel, and tool steel		Stainless steel		Grey cast iron		Nodular cast iron		Malleable cast iron		
VDI 3323	1	2	3	4	5	6	7	8	9	10	11	12	13	14	15	16	17	18	19	20	
HRc	13	25	28	32	38	10	29	32	38	15	35	15	23	10	10	26	3	25	21	21	
HB	125	190	250	270	300	180	275	300	350	200	325	200	240	180	180	260	160	250	130	230	
Recommend	○	○	◎	◎	◎	○	◎	◎	◎	○	◎	○	○	○	○	○	○	○	○	○	○

ISO Material Description	N					S					H												
	Aluminum-wrought alloy		Aluminum-cast, alloyed			Copper and Copper Alloys (Bronze / Brass)		Non Metallic Materials			Heat Resistant Super Alloys					Titanium Alloys		Hardened steel		Chilled Cast Iron		Hardened Cast Iron	
VDI 3323	21	22	23	24	25	26	27	28	29	30	31	32	33	34	35	36	37	38	39	40	41	42	43
HRc	21	22	23	24	25	26	27	28	29	30	31	32	33	34	35	36	37	38	39	40	41	42	43
HB	60	100	75	90	130	110	90	100			200	280	250	350	320	400 Rm	1050 Rm	550	630	400	550	42	55
Recommend																		○	◎	◎	○	○	○

CARBIDE, 2 FLUTE with EXTENDED NECK

- VOLLHARTMETALL, 2 SCHNEIDEN mit ABGESETZTEM SCHAFTTETEL
- Fraise carbure, 2 dents, détalonnée
- MD, 2 TAGLIENTI, SPIGOLO VIVO, SERIE LUNGA

- ▶ New coating and tool geometry applied resulting outstanding cutting abilities and wear resistance.
- ▶ Excellent for cutting prehardened steels, carbon steels, alloy steels of molds and dies, up to HRC55 and machine parts.
- ▶ For 1.0mm and under 1.0mm diameter size products, it is designed with a double neck to increase tool rigidity and to minimize vibration.
- ▶ Available in several effective lengths of cut and also overall lengths to apply on various rib processing.

- ▶ Aufgrund einer neuartigen Beschichtung und neuer Werkzeuggeometrien hervorragende Schnittleistung und Verschleißfestigkeit
- ▶ Ausgezeichnet geeignet für das Fräsen von vorvergütetem Stahl, kohlenstoff Stahl, legiertem Stahl für Formen, bis HRC55 und Maschinenbauteile.
- ▶ Bei Fräsen mit einem $\phi \leq 1,0$ mm gewährleistet die "Doppel-Hals-Geometrie" eine erhöhte Werkzeugsteifigkeit und minimiert Vibrationen während der Bearbeitung.
- ▶ Die Auswahl an verschiedenen Effektiv- und Gesamtlängen der Werkzeuge ermöglicht die Herstellung der verschiedensten Steg- und Rippen-Variationen.

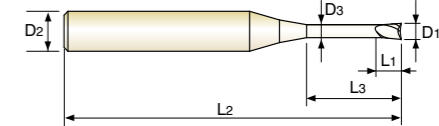

CARBIDE
2
30°
PLAIN
Coating
Y
p.C300-309

Flat Shank	Page	Plain Shank	Page
END MILL HOLDER	D118-137	HYDRAULIC CHUCK SHRINK FIT HOLDER	D15-46 D47-72
-	-	POWER MILLING CHUCK	D161-176
-	-	ER COLLET CHUCK SK SLIM CHUCK	D73-116 D183-201

Unit : mm

EDP No.	Mill Diameter	Shank Diameter	Length of Cut	Length Below Shank	Overall Length	Neck Diameter
	D1	D2	L1	L3	L2	D3
SEM845001003E	0.1	4	0.15	0.3	40	0.085
★ SEM845001005E	0.1	4	0.15	0.5	40	0.085
SEM84500101E	0.1	4	0.15	1	40	0.085
SEM84500150035SE	0.15	4	0.2	0.35	40	0.13
★ SEM845002005E	0.2	4	0.3	0.5	40	0.17
★ SEM84500201E	0.2	4	0.3	1	40	0.17
★ SEM845002015E	0.2	4	0.3	1.5	40	0.17
★ SEM84500202E	0.2	4	0.3	2	40	0.17
★ SEM84500301E	0.3	4	0.5	1	40	0.27
★ SEM845003015E	0.3	4	0.5	1.5	40	0.27
★ SEM84500302E	0.3	4	0.5	2	40	0.27
SEM845003025E	0.3	4	0.5	2.5	40	0.27
★ SEM84500303E	0.3	4	0.5	3	40	0.27
★ SEM84500304E	0.3	4	0.5	4	40	0.27
SEM84500305E	0.3	4	0.5	5	40	0.27
★ SEM84500401E	0.4	4	0.6	1	40	0.37
★ SEM845004015E	0.4	4	0.6	1.5	40	0.37
★ SEM84500402E	0.4	4	0.6	2	40	0.37
★ SEM845004025E	0.4	4	0.6	2.5	40	0.37
★ SEM84500403E	0.4	4	0.6	3	40	0.37
★ SEM84500404E	0.4	4	0.6	4	40	0.37
★ SEM84500405E	0.4	4	0.6	5	40	0.37
SEM84500406E	0.4	4	0.6	6	40	0.37
SEM84500408E	0.4	4	0.6	8	40	0.37

★ : Stock Item

Size	Mill Dia. Tolerance (mm)	Shank Dia. Tolerance
up to $\phi 6$	0 ~ - 0.012	h5
over $\phi 6$	0 ~ - 0.015	

◎ : Excellent ○ : Good

ISO Material Description	P										M				K						
	Non-alloy steel					Low alloy steel					High alloyed steel, and tool steel		Stainless steel		Grey cast iron		Nodular cast iron		Malleable cast iron		
VDI 3323	1	2	3	4	5	6	7	8	9	10	11	12	13	14	15	16	17	18	19	20	
HRc	13	25	28	32	38	10	29	32	38	15	35	15	23	10	10	26	3	25	21	21	
HB	125	190	250	270	300	180	275	300	350	200	325	200	240	180	180	260	160	250	130	230	
Recommend	○	○	◎	◎	◎	○	◎	◎	◎	○	◎	○	○	○	○	○	○	○	○	○	○

ISO Material Description	N					S					H												
	Aluminum-wrought alloy		Aluminum-cast, alloyed			Copper and Copper Alloys (Bronze / Brass)		Non Metallic Materials			Heat Resistant Super Alloys					Titanium Alloys		Hardened steel		Chilled Cast Iron		Hardened Cast Iron	
VDI 3323	21	22	23	24	25	26	27	28	29	30	31	32	33	34	35	36	37	38	39	40	41	42	43
HRc	21	22	23	24	25	26	27	28	29	30	31	32	33	34	35	36	37	38	39	40	41	42	43
HB	60	100	75	90	130	110	90	100			200	280	250	350	320	400 Rm	1050 Rm	550	630	400	550	42	55
Recommend																		○	◎	◎	○	○	○

▶ NEXT PAGE

CARBIDE, 2 FLUTE with EXTENDED NECK

- VOLLHARTMETALL, 2 SCHNEIDEN mit ABGESETZTEM SCHAFTTETL
- Fraise carbure, 2 dents, détalonnée
- MD, 2 TAGLIENTI, SPIGOLO VIVO, SERIE LUNGA

- ▶ New coating and tool geometry applied resulting outstanding cutting abilities and wear resistance.
- ▶ Excellent for cutting prehardened steels, carbon steels, alloy steels of molds and dies, up to HRC55 and machine parts.
- ▶ For 1.0mm and under 1.0mm diameter size products, it is designed with a double neck to increase tool rigidity and to minimize vibration.
- ▶ Available in several effective lengths of cut and also overall lengths to apply on various rib processing.

- ▶ Aufgrund einer neuartigen Beschichtung und neuer Werkzeuggeometrien hervorragende Schnittleistung und Verschleißfestigkeit
- ▶ Ausgezeichnet geeignet für das Fräsen von vorvergütetem Stahl, kohlenstoff Stahl, legiertem Stahl für Formen, bis HRC55 und Maschinenbauteile.
- ▶ Bei Fräsem mit einem $\phi \leq 1,0\text{mm}$ gewährleistet die "Doppel-Hals-Geometrie" eine erhöhte Werkzeugsteifigkeit und minimiert Vibrationen während der Bearbeitung.
- ▶ Die Auswahl an verschiedenen Effektiv- und Gesamt-Längen der Werkzeuge ermöglicht die Herstellung der verschiedensten Steg- und Rippen-Variationen.



Flat Shank	Page	Plain Shank	Page
END MILL HOLDER	D118-137	HYDRAULIC CHUCK SHRINK FIT HOLDER	D15-46 D47-72
-	-	POWER MILLING CHUCK	D161-176
-	-	ER COLLET CHUCK SK SLIM CHUCK	D73-116 D183-201

Unit : mm

EDP No.	Mill Diameter	Shank Diameter	Length of Cut	Length Below Shank	Overall Length	Neck Diameter
	D1	D2	L1	L3	L2	D3
SEM84500410E	0.4	4	0.6	10	40	0.37
★ SEM84500501E	0.5	4	0.7	1	45	0.45
SEM845005015E	0.5	4	0.7	1.5	45	0.45
★ SEM84500502E	0.5	4	0.7	2	45	0.45
SEM845005025E	0.5	4	0.7	2.5	45	0.45
★ SEM84500503E	0.5	4	0.7	3	45	0.45
★ SEM84500504E	0.5	4	0.7	4	45	0.45
★ SEM84500505E	0.5	4	0.7	5	45	0.45
★ SEM84500506E	0.5	4	0.7	6	45	0.45
SEM84500508E	0.5	4	0.7	8	45	0.45
SEM84500510E	0.5	4	0.7	10	45	0.45
SEM84500512E	0.5	4	0.7	12	45	0.45
SEM84500514E	0.5	4	0.7	14	45	0.45
SEM84500516E	0.5	4	0.7	16	45	0.45
★ SEM84500602E	0.6	4	0.9	2	45	0.55
★ SEM84500603E	0.6	4	0.9	3	45	0.55
★ SEM84500604E	0.6	4	0.9	4	45	0.55
★ SEM84500605E	0.6	4	0.9	5	45	0.55
★ SEM84500606E	0.6	4	0.9	6	45	0.55
★ SEM84500608E	0.6	4	0.9	8	45	0.55
★ SEM84500610E	0.6	4	0.9	10	45	0.55
SEM84500612E	0.6	4	0.9	12	45	0.55
SEM84500614E	0.6	4	0.9	14	45	0.55
SEM84500616E	0.6	4	0.9	16	45	0.55

★ : Stock Item

▶ NEXT PAGE

Size	Mill Dia. Tolerance (mm)	Shank Dia. Tolerance
up to Ø6	0 ~ - 0.012	h5
over Ø6	0 ~ - 0.015	

◎ : Excellent ○ : Good

ISO	P										M				K					
	Non-alloy steel					Low alloy steel					High alloyed steel, and tool steel		Stainless steel		Grey cast iron	Nodular cast iron	Malleable cast iron			
Material Description	1	2	3	4	5	6	7	8	9	10	11	12	13	14	15	16	17	18	19	20
VDI 3323	1	2	3	4	5	6	7	8	9	10	11	12	13	14	15	16	17	18	19	20
HRc	13	25	28	32	30	29	32	38	35	35	15	23	10	10	26	3	25	21		
HB	125	190	250	270	300	180	275	300	350	200	325	200	240	180	180	260	160	250	130	230
Recommend	○	○	◎	◎	◎	○	◎	◎	◎	◎	○	○	○	○	○	○	○	○	○	○

ISO	N										S					H					
	Aluminum-wrought alloy		Aluminum-cast, alloyed			Copper and Copper Alloys (Bronze / Brass)					Non Metallic Materials		Heat Resistant Super Alloys			Titanium Alloys		Hardened steel	Chilled Cast Iron	Hardened Cast Iron	
Material Description	21	22	23	24	25	26	27	28	29	30	31	32	33	34	35	36	37	38	39	40	41
VDI 3323	21	22	23	24	25	26	27	28	29	30	31	32	33	34	35	36	37	38	39	40	41
HRc	21	22	23	24	25	26	27	28	29	30	31	32	33	34	35	36	37	38	39	40	41
HB	60	100	75	90	130	110	90	100			200	280	250	350	320	400 Rm	1050 Rm	550	630	400	550
Recommend											○	○	○	○	○	○	○	○	○	○	○

CARBIDE, 2 FLUTE with EXTENDED NECK

- VOLLHARTMETALL, 2 SCHNEIDEN mit ABGESETZTEM SCHAFTTETL
- Fraise carbure, 2 dents, détalonnée
- MD, 2 TAGLIENTI, SPIGOLO VIVO, SERIE LUNGA

- ▶ New coating and tool geometry applied resulting outstanding cutting abilities and wear resistance.
- ▶ Excellent for cutting prehardened steels, carbon steels, alloy steels of molds and dies, up to HRC55 and machine parts.
- ▶ For 1.0mm and under 1.0mm diameter size products, it is designed with a double neck to increase tool rigidity and to minimize vibration.
- ▶ Available in several effective lengths of cut and also overall lengths to apply on various rib processing.

- ▶ Aufgrund einer neuartigen Beschichtung und neuer Werkzeuggeometrien hervorragende Schnittleistung und Verschleißfestigkeit
- ▶ Ausgezeichnet geeignet für das Fräsen von vorvergütetem Stahl, kohlenstoff Stahl, legiertem Stahl für Formen, bis HRC55 und Maschinenbauteile.
- ▶ Bei Fräsem mit einem $\phi \leq 1,0\text{mm}$ gewährleistet die "Doppel-Hals-Geometrie" eine erhöhte Werkzeugsteifigkeit und minimiert Vibrationen während der Bearbeitung.
- ▶ Die Auswahl an verschiedenen Effektiv- und Gesamt-Längen der Werkzeuge ermöglicht die Herstellung der verschiedensten Steg- und Rippen-Variationen.



Flat Shank	Page	Plain Shank	Page
END MILL HOLDER	D118-137	HYDRAULIC CHUCK SHRINK FIT HOLDER	D15-46 D47-72
-	-	POWER MILLING CHUCK	D161-176
-	-	ER COLLET CHUCK SK SLIM CHUCK	D73-116 D183-201

Unit : mm

EDP No.	Mill Diameter	Shank Diameter	Length of Cut	Length Below Shank	Overall Length	Neck Diameter
	D1	D2	L1	L3	L2	D3
★ SEM84500702E	0.7	4	1.2	2	45	0.65
★ SEM84500704E	0.7	4	1.2	4	45	0.65
★ SEM84500706E	0.7	4	1.2	6	45	0.65
SEM84500708E	0.7	4	1.2	8	45	0.65
SEM84500710E	0.7	4	1.2	10	45	0.65
SEM84500712E	0.7	4	1.2	12	45	0.65
★ SEM84500802E	0.8	4	1.2	2	45	0.75
★ SEM84500803E	0.8	4	1.2	3	45	0.75
★ SEM84500804E	0.8	4	1.2	4	45	0.75
★ SEM84500805E	0.8	4	1.2	5	45	0.75
★ SEM84500806E	0.8	4	1.2	6	45	0.75
★ SEM84500808E	0.8	4	1.2	8	45	0.75
★ SEM84500810E	0.8	4	1.2	10	45	0.75
SEM84500812E	0.8	4	1.2	12	45	0.75
SEM84500814E	0.8	4	1.2	14	45	0.75
SEM84500816E	0.8	4	1.2	16	45	0.75
SEM84500820E	0.8	4	1.2	20	45	0.75
SEM84500906E	0.9	4	1.3	6	45	0.85
SEM84500908E	0.9	4	1.3	8	45	0.85
SEM84500910E	0.9	4	1.3	10	45	0.85
★ SEM84501002E	1.0	4	1.5	2	50	0.95
★ SEM84501003E	1.0	4	1.5	3	50	0.95
★ SEM84501004E	1.0	4	1.5	4	50	0.95
★ SEM84501005E	1.0	4	1.5	5	50	0.95

★ : Stock Item

▶ NEXT PAGE

Size	Mill Dia. Tolerance (mm)	Shank Dia. Tolerance
up to Ø6	0 ~ - 0.012	h5
over Ø6	0 ~ - 0.015	

◎ : Excellent ○ : Good

ISO	P										M				K					
	Non-alloy steel					Low alloy steel					High alloyed steel, and tool steel		Stainless steel		Grey cast iron	Nodular cast iron	Malleable cast iron			
Material Description	1	2	3	4	5	6	7	8	9	10	11	12	13	14	15	16	17	18	19	20
VDI 3323	1	2	3	4	5	6	7	8	9	10	11	12	13	14	15	16	17	18	19	20
HRc	13	25	28	32	30	29	32	38	35	35	15	23	10	10	26	3	25	21		
HB	125	190	250	270	300	180	275	300	350	200	325	200	240	180	180	260	160	250	130	230
Recommend	○	○	◎	◎	◎	○	◎	◎	◎	◎	○	○	○	○	○	○	○	○	○	○

ISO	N										S					H					
	Aluminum-wrought alloy		Aluminum-cast, alloyed			Copper and Copper Alloys (Bronze / Brass)					Non Metallic Materials		Heat Resistant Super Alloys			Titanium Alloys		Hardened steel	Chilled Cast Iron	Hardened Cast Iron	
Material Description	21	22	23	24	25	26	27	28	29	30	31	32	33	34	35	36	37	38	39	40	41
VDI 3323	21	22	23	24	25	26	27	28	29	30	31	32	33	34	35	36	37	38	39	40	41
HRc	21	22	23	24	25	26	27	28	29	30	31	32	33	34	35	36	37	38	39	40	41
HB	60	100	75	90	130	110	90	100			200	280	250	350	320	400 Rm	1050 Rm	550	630	400	550
Recommend											○	○	○	○	○	○	○	○	○	○	○

CARBIDE, 2 FLUTE with EXTENDED NECK

- VOLLHARTMETALL, 2 SCHNEIDEN mit ABGESETZTEM SCHAFTTETL
- () Fraise carbure, 2 dents, détalonnée
- () MD, 2 TAGLIENTI, SPIGOLO VIVO, SERIE LUNGA

- ▶ New coating and tool geometry applied resulting outstanding cutting abilities and wear resistance.
- ▶ Excellent for cutting prehardened steels, carbon steels, alloy steels of molds and dies, up to HRC55 and machine parts.
- ▶ For 1.0mm and under 1.0mm diameter size products, it is designed with a double neck to increase tool rigidity and to minimize vibration.
- ▶ Available in several effective lengths of cut and also overall lengths to apply on various rib processing.

- ▶ Aufgrund einer neuartigen Beschichtung und neuer Werkzeuggeometrien hervorragende Schnittleistung und Verschleißfestigkeit
- ▶ Ausgezeichnet geeignet für das Fräsen von vorvergütetem Stahl, kohlenstoff Stahl, legiertem Stahl für Formen, bis HRC55 und Maschinenbauteile.
- ▶ Bei Fräsem mit einem $\phi \leq 1,0\text{mm}$ gewährleistet die "Doppel-Hals-Geometrie" eine erhöhte Werkzeugsteifigkeit und minimiert Vibrationen während der Bearbeitung.
- ▶ Die Auswahl an verschiedenen Effektiv- und Gesamt-Längen der Werkzeuge ermöglicht die Herstellung der verschiedensten Steg- und Rippen-Variationen.



Flat Shank	Page	Plain Shank	Page
END MILL HOLDER	D118-137	HYDRAULIC CHUCK SHRINK FIT HOLDER	D15-46 D47-72
-	-	POWER MILLING CHUCK	D161-176
-	-	ER COLLET CHUCK SK SLIM CHUCK	D73-116 D183-201

Unit : mm

EDP No.	Mill Diameter	Shank Diameter	Length of Cut	Length Below Shank	Overall Length	Neck Diameter
	D1	D2	L1	L3	L2	D3
★ SEM84501006E	1.0	4	1.5	6	50	0.95
SEM84501007E	1.0	4	1.5	7	50	0.95
★ SEM84501008E	1.0	4	1.5	8	50	0.95
★ SEM84501010E	1.0	4	1.5	10	50	0.95
★ SEM84501012E	1.0	4	1.5	12	50	0.95
★ SEM84501014E	1.0	4	1.5	14	50	0.95
★ SEM84501016E	1.0	4	1.5	16	50	0.95
SEM84501018E	1.0	4	1.5	18	50	0.95
★ SEM84501020E	1.0	4	1.5	20	50	0.95
SEM84501022E	1.0	4	1.5	22	60	0.95
SEM84501026E	1.0	4	1.5	26	60	0.95
SEM84501030E	1.0	4	1.5	30	70	0.95
SEM84501040E	1.0	4	1.5	40	80	0.95
SEM84501050E	1.0	4	1.5	50	100	0.95
SEM84501204E	1.2	4	1.8	4	50	1.15
★ SEM84501206E	1.2	4	1.8	6	50	1.15
★ SEM84501208E	1.2	4	1.8	8	50	1.15
★ SEM84501210E	1.2	4	1.8	10	50	1.15
★ SEM84501212E	1.2	4	1.8	12	50	1.15
SEM84501214E	1.2	4	1.8	14	50	1.15
SEM84501216E	1.2	4	1.8	16	50	1.15
SEM84501220E	1.2	4	1.8	20	50	1.15
SEM84501226E	1.2	4	1.8	26	60	1.15
SEM84501230E	1.2	4	1.8	30	70	1.15

★ : Stock Item

▶ NEXT PAGE

Size	Mill Dia. Tolerance (mm)	Shank Dia. Tolerance
up to Ø6	0 ~ - 0.012	h5
over Ø6	0 ~ - 0.015	

◎ : Excellent ○ : Good

ISO Material Description	P										M				K					
	Non-alloy steel					Low alloy steel					High alloyed steel, and tool steel		Stainless steel		Grey cast iron	Nodular cast iron		Malleable cast iron		
VDI 3323	1	2	3	4	5	6	7	8	9	10	11	12	13	14	15	16	17	18	19	20
HRc	13	25	28	32	30	29	32	38	35	35	15	23	10	10	26	3	25	21		
HB	125	190	250	270	300	180	275	300	350	200	325	200	240	180	180	260	160	250	130	230
Recommend	○	○	◎	◎	◎	○	◎	◎	◎	◎	○	○	○	○	○	○	○	○	○	○

ISO Material Description	N										S				H						
	Aluminum-wrought alloy		Aluminum-cast, alloyed		Copper and Copper Alloys (Bronze / Brass)		Non Metallic Materials		Heat Resistant Super Alloys				Titanium Alloys		Hardened steel	Chilled Cast Iron	Hardened Cast Iron				
VDI 3323	21	22	23	24	25	26	27	28	29	30	31	32	33	34	35	36	37	38	39	40	41
HRc											15	30	25	38	34			55	60	42	55
HB	60	100	75	90	130	110	90	100			200	280	250	350	320	400 Rm	1050 Rm	550	630	400	550
Recommend											○	○	○	○	○	○	○	○	◎	○	○

CARBIDE, 2 FLUTE with EXTENDED NECK

- VOLLHARTMETALL, 2 SCHNEIDEN mit ABGESETZTEM SCHAFTTETL
- () Fraise carbure, 2 dents, détalonnée
- () MD, 2 TAGLIENTI, SPIGOLO VIVO, SERIE LUNGA

- ▶ New coating and tool geometry applied resulting outstanding cutting abilities and wear resistance.
- ▶ Excellent for cutting prehardened steels, carbon steels, alloy steels of molds and dies, up to HRC55 and machine parts.
- ▶ For 1.0mm and under 1.0mm diameter size products, it is designed with a double neck to increase tool rigidity and to minimize vibration.
- ▶ Available in several effective lengths of cut and also overall lengths to apply on various rib processing.

- ▶ Aufgrund einer neuartigen Beschichtung und neuer Werkzeuggeometrien hervorragende Schnittleistung und Verschleißfestigkeit
- ▶ Ausgezeichnet geeignet für das Fräsen von vorvergütetem Stahl, kohlenstoff Stahl, legiertem Stahl für Formen, bis HRC55 und Maschinenbauteile.
- ▶ Bei Fräsem mit einem $\phi \leq 1,0\text{mm}$ gewährleistet die "Doppel-Hals-Geometrie" eine erhöhte Werkzeugsteifigkeit und minimiert Vibrationen während der Bearbeitung.
- ▶ Die Auswahl an verschiedenen Effektiv- und Gesamt-Längen der Werkzeuge ermöglicht die Herstellung der verschiedensten Steg- und Rippen-Variationen.



Flat Shank	Page	Plain Shank	Page
END MILL HOLDER	D118-137	HYDRAULIC CHUCK SHRINK FIT HOLDER	D15-46 D47-72
-	-	POWER MILLING CHUCK	D161-176
-	-	ER COLLET CHUCK SK SLIM CHUCK	D73-116 D183-201

Unit : mm

EDP No.	Mill Diameter	Shank Diameter	Length of Cut	Length Below Shank	Overall Length	Neck Diameter
	D1	D2	L1	L3	L2	D3
★ SEM84501406E	1.4	4	2.1	6	50	1.35
★ SEM84501408E	1.4	4	2.1	8	50	1.35
SEM84501410E	1.4	4	2.1	10	50	1.35
SEM84501414E	1.4	4	2.1	14	50	1.35
SEM84501416E	1.4	4	2.1	16	50	1.35
SEM84501420E	1.4	4	2.1	20	50	1.35
★ SEM84501504E	1.5	4	2.3	4	50	1.45
SEM84501505E	1.5	4	2.3	5	50	1.45
★ SEM84501506E	1.5	4	2.3	6	50	1.45
SEM84501507E	1.5	4	2.3	7	50	1.45
★ SEM84501508E	1.5	4	2.3	8	50	1.45
★ SEM84501510E	1.5	4	2.3	10	50	1.45
★ SEM84501512E	1.5	4	2.3	12	50	1.45
★ SEM84501514E	1.5	4	2.3	14	50	1.45
★ SEM84501516E	1.5	4	2.3	16	50	1.45
★ SEM84501518E	1.5	4	2.3	18	50	1.45
★ SEM84501520E	1.5	4	2.3	20	50	1.45
SEM84501522E	1.5	4	2.3	22	60	1.45
SEM84501526E	1.5	4	2.3	26	60	1.45
SEM84501530E	1.5	4	2.3	30	70	1.45
SEM84501608E	1.6	4	2.3	8	50	1.55
SEM84501610E	1.6	4	2.3	10	50	1.55
SEM84501612E	1.6	4	2.3	12	50	1.55
SEM84501616E	1.6	4	2.3	16	50	1.55

★ : Stock Item

▶ NEXT PAGE

Size	Mill Dia. Tolerance (mm)	Shank Dia. Tolerance
up to Ø6	0 ~ - 0.012	h5
over Ø6	0 ~ - 0.015	

◎ : Excellent ○ : Good

ISO Material Description	P										M				K					
	Non-alloy steel					Low alloy steel					High alloyed steel, and tool steel		Stainless steel		Grey cast iron	Nodular cast iron		Malleable cast iron		
VDI 3323	1	2	3	4	5	6	7	8	9	10	11	12	13	14	15	16	17	18	19	20
HRc	13	25	28	32	30	29	32	38	35	35	15	23	10	10	26	3	25	21		
HB	125	190	250	270	300	180	275	300	350	200	325	200	240	180	180	260	160	250	130	230
Recommend	○	○	◎	◎	◎	○	◎	◎	◎	○	◎	○	○	○	○	○	○	○	○	○

ISO Material Description	N										S				H						
	Aluminum-wrought alloy		Aluminum-cast, alloyed		Copper and Copper Alloys (Bronze / Brass)		Non Metallic Materials		Heat Resistant Super Alloys				Titanium Alloys		Hardened steel	Chilled Cast Iron	Hardened Cast Iron				
VDI 3323	21	22	23	24	25	26	27	28	29	30	31	32	33	34	35	36	37	38	39	40	41
HRc											15	30	25	38	34			55	60	42	55
HB	60	100	75	90	130	110	90	100			200	280	250	350	320	400 Rm	1050 Rm	550	630	400	550
Recommend											○	○	○	○	○	○	○	○	◎	○	○



PLAIN SHANK SEM845 SERIES

CARBIDE, 2 FLUTE with EXTENDED NECK

- VOLLHARTMETALL, 2 SCHNEIDEN mit ABGESETZTEM SCHAFTTETL
- (●) Fraise carbure, 2 dents, détalonnée
- (●) MD, 2 TAGLIENTI, SPIGOLO VIVO, SERIE LUNGA

- ▶ New coating and tool geometry applied resulting outstanding cutting abilities and wear resistance.
- ▶ Excellent for cutting prehardened steels, carbon steels, alloy steels of molds and dies, up to HRC55 and machine parts.
- ▶ For 1.0mm and under 1.0mm diameter size products, it is designed with a double neck to increase tool rigidity and to minimize vibration.
- ▶ Available in several effective lengths of cut and also overall lengths to apply on various rib processing.

- ▶ Aufgrund einer neuartigen Beschichtung und neuer Werkzeuggeometrien hervorragende Schnittleistung und Verschleißfestigkeit
- ▶ Ausgezeichnet geeignet für das Fräsen von vorvergrütetem Stahl, kohlenstoff Stahl, legiertem Stahl für Formen, bis HRC55 und Maschinenbauteile.
- ▶ Bei Fräsem mit einem $\phi \leq 1,0\text{mm}$ gewährleistet die "Doppel-Hals-Geometrie" eine erhöhte Werkzeugsteifigkeit und minimiert Vibrationen während der Bearbeitung.
- ▶ Die Auswahl an verschiedenen Effektiv- und Gesamt-Längen der Werkzeuge ermöglicht die Herstellung der verschiedensten Steg- und Rippen-Variationen.



Flat Shank	Page	Plain Shank	Page
END MILL HOLDER	D118-137	HYDRAULIC CHUCK SHRINK FIT HOLDER	D15-46 D47-72
-	-	POWER MILLING CHUCK	D161-176
-	-	ER COLLET CHUCK SK SLIM CHUCK	D73-116 D183-201

Unit : mm

EDP No.	Mill Diameter	Shank Diameter	Length of Cut	Length Below Shank	Overall Length	Neck Diameter
	D1	D2	L1	L3	L2	D3
SEM84501620E	1.6	4	2.3	20	50	1.55
★ SEM84501808E	1.8	4	2.7	8	50	1.75
★ SEM84501810E	1.8	4	2.7	10	50	1.75
★ SEM84501812E	1.8	4	2.7	12	50	1.75
SEM84501816E	1.8	4	2.7	16	50	1.75
SEM84501820E	1.8	4	2.7	20	50	1.75
★ SEM84502006E	2.0	4	3	6	50	1.95
★ SEM84502008E	2.0	4	3	8	50	1.95
★ SEM84502010E	2.0	4	3	10	50	1.95
★ SEM84502012E	2.0	4	3	12	50	1.95
★ SEM84502014E	2.0	4	3	14	50	1.95
★ SEM84502016E	2.0	4	3	16	50	1.95
SEM84502018E	2.0	4	3	18	50	1.95
★ SEM84502020E	2.0	4	3	20	50	1.95
SEM84502022E	2.0	4	3	22	60	1.95
★ SEM84502026E	2.0	4	3	26	60	1.95
★ SEM84502030E	2.0	4	3	30	70	1.95
★ SEM84502035E	2.0	4	3	35	70	1.95
★ SEM84502040E	2.0	4	3	40	80	1.95
SEM84502045E	2.0	4	3	45	90	1.95
SEM84502050E	2.0	4	3	50	100	1.95
SEM84502060E	2.0	4	3	60	110	1.95
★ SEM84502508E	2.5	4	4	8	50	2.40
★ SEM84502510E	2.5	4	4	10	50	2.40

★ : Stock Item

▶ NEXT PAGE

Size	Mill Dia. Tolerance (mm)	Shank Dia. Tolerance
up to Ø6	0 ~ - 0.012	h5
over Ø6	0 ~ - 0.015	

◎ : Excellent ○ : Good

ISO Material Description	P										M				K					
	Non-alloy steel					Low alloy steel					High alloyed steel, and tool steel		Stainless steel		Grey cast iron	Nodular cast iron		Malleable cast iron		
VDI 3323	1	2	3	4	5	6	7	8	9	10	11	12	13	14	15	16	17	18	19	20
HRc	13	25	28	32	30	29	32	38	35	35	15	23	10	10	26	3	25	21		
HB	125	190	250	270	300	180	275	300	350	200	325	200	240	180	180	260	160	250	130	230
Recommend	○	○	◎	◎	◎	○	◎	◎	◎	◎	○	○	○	○	○	○	○	○	○	○

ISO Material Description	N										S					H					
	Aluminum-wrought alloy		Aluminum-cast, alloyed			Copper and Copper Alloys (Bronze / Brass)					Non Metallic Materials		Heat Resistant Super Alloys			Titanium Alloys		Hardened steel	Chilled Cast Iron	Hardened Cast Iron	
VDI 3323	21	22	23	24	25	26	27	28	29	30	31	32	33	34	35	36	37	38	39	40	41
HRc											15	30	25	38	34			55	60	42	55
HB	60	100	75	90	130	110	90	100			200	280	250	350	320	400 Rm	1050 Rm	550	630	400	550
Recommend											○	○	○	○	○	○	○	○	○	◎	○



PLAIN SHANK SEM845 SERIES

CARBIDE, 2 FLUTE with EXTENDED NECK

- VOLLHARTMETALL, 2 SCHNEIDEN mit ABGESETZTEM SCHAFTTETL
- (●) Fraise carbure, 2 dents, détalonnée
- (●) MD, 2 TAGLIENTI, SPIGOLO VIVO, SERIE LUNGA

- ▶ New coating and tool geometry applied resulting outstanding cutting abilities and wear resistance.
- ▶ Excellent for cutting prehardened steels, carbon steels, alloy steels of molds and dies, up to HRC55 and machine parts.
- ▶ For 1.0mm and under 1.0mm diameter size products, it is designed with a double neck to increase tool rigidity and to minimize vibration.
- ▶ Available in several effective lengths of cut and also overall lengths to apply on various rib processing.

- ▶ Aufgrund einer neuartigen Beschichtung und neuer Werkzeuggeometrien hervorragende Schnittleistung und Verschleißfestigkeit
- ▶ Ausgezeichnet geeignet für das Fräsen von vorvergrütetem Stahl, kohlenstoff Stahl, legiertem Stahl für Formen, bis HRC55 und Maschinenbauteile.
- ▶ Bei Fräsem mit einem $\phi \leq 1,0\text{mm}$ gewährleistet die "Doppel-Hals-Geometrie" eine erhöhte Werkzeugsteifigkeit und minimiert Vibrationen während der Bearbeitung.
- ▶ Die Auswahl an verschiedenen Effektiv- und Gesamt-Längen der Werkzeuge ermöglicht die Herstellung der verschiedensten Steg- und Rippen-Variationen.



Flat Shank	Page	Plain Shank	Page
END MILL HOLDER	D118-137	HYDRAULIC CHUCK SHRINK FIT HOLDER	D15-46 D47-72
-	-	POWER MILLING CHUCK	D161-176
-	-	ER COLLET CHUCK SK SLIM CHUCK	D73-116 D183-201

Unit : mm

EDP No.	Mill Diameter	Shank Diameter	Length of Cut	Length Below Shank	Overall Length	Neck Diameter
	D1	D2	L1	L3	L2	D3
★ SEM84502512E	2.5	4	4	12	50	2.40
SEM84502514E	2.5	4	4	14	50	2.40
★ SEM84502516E	2.5	4	4	16	50	2.40
SEM84502518E	2.5	4	4	18	50	2.40
★ SEM84502520E	2.5	4	4	20	50	2.40
SEM84502522E	2.5	4	4	22	60	2.40
★ SEM84502526E	2.5	4	4	26	60	2.40
SEM84502530E	2.5	4	4	30	70	2.40
SEM84502535E	2.5	4	4	35	70	2.40
SEM84502540E	2.5	4	4	40	80	2.40
SEM84502545E	2.5	4	4	45	90	2.40
SEM84502550E	2.5	4	4	50	100	2.40
★ SEM84503006E	3.0	6	4.5	6	50	2.85
★ SEM84503008E	3.0	6	4.5	8	50	2.85
★ SEM84503010E	3.0	6	4.5	10	50	2.85
★ SEM84503012E	3.0	6	4.5	12	50	2.85
★ SEM84503014E	3.0	6	4.5	14	60	2.85
★ SEM84503016E	3.0	6	4.5	16	60	2.85
★ SEM84503018E	3.0	6	4.5	18	60	2.85
★ SEM84503020E	3.0	6	4.5	20	60	2.85
SEM84503022E	3.0	6	4.5	22	65	2.85
★ SEM84503026E	3.0	6	4.5	26	65	2.85
★ SEM84503030E	3.0	6	4.5	30	70	2.85
★ SEM84503035E	3.0	6	4.5	35	70	2.85

★ : Stock Item

▶ NEXT PAGE

Size	Mill Dia. Tolerance (mm)	Shank Dia. Tolerance
up to Ø6	0 ~ - 0.012	h5
over Ø6	0 ~ - 0.015	

◎ : Excellent ○ : Good

ISO Material Description	P										M				K					
	Non-alloy steel					Low alloy steel					High alloyed steel, and tool steel		Stainless steel		Grey cast iron	Nodular cast iron		Malleable cast iron		
VDI 3323	1	2	3	4	5	6	7	8	9	10	11	12	13	14	15	16	17	18	19	20
HRc	13	25	28	32	30	29	32	38	35	35	15	23	10	10	26	3	25	21		
HB	125	190	250	270	300	180	275	300	350	200	325	200	240	180	180	260	160	250	130	230
Recommend	○	○	◎	◎	◎	○	◎	◎	◎	○	◎	○	○	○	○	○	○	○	○	○

ISO Material Description	N										S					H					
	Aluminum-wrought alloy		Aluminum-cast, alloyed			Copper and Copper Alloys (Bronze / Brass)					Non Metallic Materials		Heat Resistant Super Alloys			Titanium Alloys		Hardened steel	Chilled Cast Iron	Hardened Cast Iron	
VDI 3323	21	22	23	24	25	26	27	28	29	30	31	32	33	34	35	36	37	38	39	40	41
HRc											15	30	25	38	34			55	60	42	55
HB	60	100	75	90	130	110	90	100			200	280	250	350	320	400 Rm	1050 Rm	550	630	400	550
Recommend											○	○	○	○	○	○	○	○	○	◎	○

CARBIDE, 2 FLUTE with EXTENDED NECK

- VOLLHARTMETALL, 2 SCHNEIDEN mit ABGESETZTEM SCHAFTTETL
- (●) Fraise carbure, 2 dents, détalonnée
- (●) MD, 2 TAGLIENTI, SPIGOLO VIVO, SERIE LUNGA

- ▶ New coating and tool geometry applied resulting outstanding cutting abilities and wear resistance.
- ▶ Excellent for cutting prehardened steels, carbon steels, alloy steels of molds and dies, up to HRC55 and machine parts.
- ▶ For 1.0mm and under 1.0mm diameter size products, it is designed with a double neck to increase tool rigidity and to minimize vibration.
- ▶ Available in several effective lengths of cut and also overall lengths to apply on various rib processing.

- ▶ Aufgrund einer neuartigen Beschichtung und neuer Werkzeuggeometrien hervorragende Schnittleistung und Verschleißfestigkeit
- ▶ Ausgezeichnet geeignet für das Fräsen von vorvergütetem Stahl, kohlenstoff Stahl, legiertem Stahl für Formen, bis HRC55 und Maschinenbauteile.
- ▶ Bei Fräsem mit einem $\phi \leq 1,0\text{mm}$ gewährleistet die "Doppel-Hals-Geometrie" eine erhöhte Werkzeugsteifigkeit und minimiert Vibrationen während der Bearbeitung.
- ▶ Die Auswahl an verschiedenen Effektiv- und Gesamt-Längen der Werkzeuge ermöglicht die Herstellung der verschiedensten Steg- und Rippen-Variationen.



Flat Shank	Page	Plain Shank	Page
END MILL HOLDER	D118-137	HYDRAULIC CHUCK SHRINK FIT HOLDER	D15-46 D47-72
-	-	POWER MILLING CHUCK	D161-176
-	-	ER COLLET CHUCK SK SLUM CHUCK	D73-116 D183-201

Unit : mm

EDP No.	Mill Diameter	Shank Diameter	Length of Cut	Length Below Shank	Overall Length	Neck Diameter
	D1	D2	L1	L3	L2	D3
★ SEM84503040E	3.0	6	4.5	40	80	2.85
SEM84503045E	3.0	6	4.5	45	90	2.85
SEM84503050E	3.0	6	4.5	50	100	2.85
SEM84503060E	3.0	6	4.5	60	100	2.85
SEM84504008E	4.0	6	6	8	50	3.85
★ SEM84504010E	4.0	6	6	10	50	3.85
★ SEM84504012E	4.0	6	6	12	50	3.85
SEM84504014E	4.0	6	6	14	60	3.85
★ SEM84504016E	4.0	6	6	16	60	3.85
★ SEM84504018E	4.0	6	6	18	60	3.85
★ SEM84504020E	4.0	6	6	20	60	3.85
SEM84504022E	4.0	6	6	22	65	3.85
★ SEM84504026E	4.0	6	6	26	65	3.85
★ SEM84504030E	4.0	6	6	30	70	3.85
★ SEM84504035E	4.0	6	6	35	70	3.85
★ SEM84504040E	4.0	6	6	40	80	3.85
★ SEM84504045E	4.0	6	6	45	90	3.85
SEM84504050E	4.0	6	6	50	100	3.85
SEM84504060E	4.0	6	6	60	100	3.85
SEM84505016E	5.0	6	8	16	60	4.85
★ SEM84505020E	5.0	6	8	20	60	4.85
SEM84505026E	5.0	6	8	26	65	4.85
★ SEM84505030E	5.0	6	8	30	70	4.85
★ SEM84505035E	5.0	6	8	35	75	4.85

★ : Stock Item

Size	Mill Dia. Tolerance (mm)	Shank Dia. Tolerance
up to Ø6	0 ~ - 0.012	h5
over Ø6	0 ~ - 0.015	

◎ : Excellent ○ : Good

ISO Material Description	P										M				K						
	Non-alloy steel					Low alloy steel					High alloyed steel, and tool steel		Stainless steel		Grey cast iron	Nodular cast iron		Malleable cast iron			
VDI 3323	1	2	3	4	5	6	7	8	9	10	11	12	13	14	15	16	17	18	19	20	
HRc	13	25	28	32	38	10	29	32	38	15	35	15	23	10	10	26	3	25	21	21	
HB	125	190	250	270	300	180	275	300	350	200	325	200	240	180	180	260	160	250	130	230	
Recommend	○	○	◎	◎	◎	○	◎	◎	◎	◎	○	○	○	○	○	○	○	○	○	○	○

CARBIDE, 2 FLUTE with EXTENDED NECK

- VOLLHARTMETALL, 2 SCHNEIDEN mit ABGESETZTEM SCHAFTTETL
- (●) Fraise carbure, 2 dents, détalonnée
- (●) MD, 2 TAGLIENTI, SPIGOLO VIVO, SERIE LUNGA

- ▶ New coating and tool geometry applied resulting outstanding cutting abilities and wear resistance.
- ▶ Excellent for cutting prehardened steels, carbon steels, alloy steels of molds and dies, up to HRC55 and machine parts.
- ▶ For 1.0mm and under 1.0mm diameter size products, it is designed with a double neck to increase tool rigidity and to minimize vibration.
- ▶ Available in several effective lengths of cut and also overall lengths to apply on various rib processing.

- ▶ Aufgrund einer neuartigen Beschichtung und neuer Werkzeuggeometrien hervorragende Schnittleistung und Verschleißfestigkeit
- ▶ Ausgezeichnet geeignet für das Fräsen von vorvergütetem Stahl, kohlenstoff Stahl, legiertem Stahl für Formen, bis HRC55 und Maschinenbauteile.
- ▶ Bei Fräsem mit einem $\phi \leq 1,0\text{mm}$ gewährleistet die "Doppel-Hals-Geometrie" eine erhöhte Werkzeugsteifigkeit und minimiert Vibrationen während der Bearbeitung.
- ▶ Die Auswahl an verschiedenen Effektiv- und Gesamt-Längen der Werkzeuge ermöglicht die Herstellung der verschiedensten Steg- und Rippen-Variationen.



Flat Shank	Page	Plain Shank	Page
END MILL HOLDER	D118-137	HYDRAULIC CHUCK SHRINK FIT HOLDER	D15-46 D47-72
-	-	POWER MILLING CHUCK	D161-176
-	-	ER COLLET CHUCK SK SLUM CHUCK	D73-116 D183-201

Unit : mm

EDP No.	Mill Diameter	Shank Diameter	Length of Cut	Length Below Shank	Overall Length	Neck Diameter
	D1	D2	L1	L3	L2	D3
★ SEM84505040E	5.0	6	8	40	80	4.85
★ SEM84505050E	5.0	6	8	50	90	4.85
SEM84505060E	5.0	6	8	60	100	4.85
★ SEM84506015E	6.0	6	9	15	60	5.85
★ SEM84506020E	6.0	6	9	20	60	5.85
★ SEM84506030E	6.0	6	9	30	70	5.85
★ SEM84506032E	6.0	6	9	32	90	5.85
★ SEM84508025E	8.0	8	12	25	70	7.70
★ SEM84508030E	8.0	8	12	30	80	7.70
★ SEM84508042E	8.0	8	12	42	100	7.70
★ SEM84510030E	10.0	10	15	30	75	9.70
SEM84510035E	10.0	10	15	35	80	9.70
★ SEM84510045E	10.0	10	15	45	100	9.70
★ SEM84512035E	12.0	12	20	35	80	11.70
SEM84512040E	12.0	12	20	40	90	11.70
★ SEM84512050E	12.0	12	20	50	110	11.70

★ : Stock Item

Size	Mill Dia. Tolerance (mm)	Shank Dia. Tolerance
up to Ø6	0 ~ - 0.012	h5
over Ø6	0 ~ - 0.015	

◎ : Excellent ○ : Good

ISO Material Description	P										M				K						
	Non-alloy steel					Low alloy steel					High alloyed steel, and tool steel		Stainless steel		Grey cast iron	Nodular cast iron		Malleable cast iron			
VDI 3323	1	2	3	4	5	6	7	8	9	10	11	12	13	14	15	16	17	18	19	20	
HRc	13	25	28	32	38	10	29	32	38	15	35	15	23	10	10	26	3	25	21	21	
HB	125	190	250	270	300	180	275	300	350	200	325	200	240	180	180	260	160	250	130	230	
Recommend	○	○	◎	◎	◎	○	◎	◎	◎	◎	○	○	○	○	○	○	○	○	○	○	○

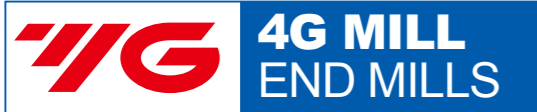

PLAIN SHANK SEME36 SERIES

CARBIDE, 4 FLUTE MULTIPLE HELIX

- VOLLHARTMETALL, 4 SCHNEIDEN MEHRSPIRAL
- Fraise carbure, 4 dents, hélice multiple
- MD, 4 TAGLIENTI, SPIGOLO VIVO

▶ New coating and tool geometry applied resulting outstanding cutting abilities and wear resistance.
 ▶ Excellent for cutting prehardened steels, carbon steels, alloy steels of molds and dies, up to HRC55 and machine parts.
 ▶ Multiple Helix for 3.0mm and over 3.0mm diameter end mills minimizing vibration and decreasing wear in cutting.

▶ Aufgrund einer neuartigen Beschichtung und neuer Werkzeuggeometrien hervorragende Schnittleistung und Verschleißfestigkeit
 ▶ Ausgezeichnet geeignet für das Fräsen von vorvergütetem Stahl, kohlenstoff Stahl, legiertem Stahl für Formen, bis HRC55 und Maschinenbauteile.
 ▶ Aufgrund der Multi-Helix (M-Helix) bei Schauffräsern ≥ 3,0mm ø werden Vibrationen zuverlässig verhindert und gleichzeitig der Schneidkantenverschleiß verringert.

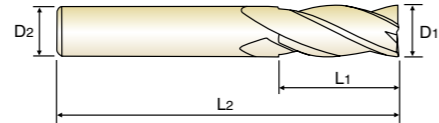

Flat Shank	Page	Plain Shank	Page
END MILL HOLDER	D118-137	HYDRAULIC CHUCK SHRINK FIT HOLDER	D15-46 D47-72
-	-	POWER MILLING CHUCK	D161-176
-	-	ER COLLET CHUCK SK SLIM CHUCK	D73-116 D183-201

D<ø3, 30° HELIX

Unit : mm

EDP No.	Mill Diameter	Shank Diameter	Length of Cut	Overall Length	Remark
	D1	D2	L1	L2	
SEME36008E	0.8	4	1.6	40	4mm Shank
SEME36009E	0.9	4	1.8	40	4mm Shank
SEME360104SE	1.0	4	2.5	50	4mm Shank
★ SEME36010E	1.0	6	2.5	50	-
SEME360124SE	1.2	4	3	50	4mm Shank
SEME36012E	1.2	6	3	50	-
SEME360154SE	1.5	4	4	50	4mm Shank
★ SEME36015E	1.5	6	4	50	-
SEME360204SE	2.0	4	6	50	4mm Shank
★ SEME36020E	2.0	6	6	50	-
SEME360254SE	2.5	4	7	50	4mm Shank
★ SEME36025E	2.5	6	7	50	-
★ SEME36030E	3.0	6	8	50	-
★ SEME36035E	3.5	6	10	50	-
★ SEME36040E	4.0	6	10	50	-
★ SEME36045E	4.5	6	14	50	-
★ SEME36050E	5.0	6	15	60	-
★ SEME36055E	5.5	6	15	60	-
★ SEME36060E	6.0	6	15	60	-
★ SEME36065E	6.5	8	18	60	-
★ SEME36070E	7.0	8	20	60	-
★ SEME36075E	7.5	8	20	60	-
★ SEME36080E	8.0	8	20	70	-
★ SEME36085E	8.5	10	22	70	-

★ : Stock Item

▶ NEXT PAGE

Mill Dia. Tolerance (mm)	Shank Dia. Tolerance
0 ~ - 0.03	h5

◎ : Excellent ○ : Good

ISO Material Description	P										M						K				
	Non-alloy steel					Low alloy steel					High alloyed steel, and tool steel		Stainless steel				Grey cast iron		Nodular cast iron	Malleable cast iron	
VDI 3323	1	2	3	4	5	6	7	8	9	10	11	12	13	14	15	16	17	18	19	20	
HRc	13	25	28	32	30	10	29	32	38	15	35	15	23	10	10	26	3	25	21	21	
HB	125	190	250	270	300	180	275	300	350	200	325	200	240	180	180	260	160	250	130	230	
Recommend	○	○	◎	◎	◎	○	◎	◎	◎	◎	◎	○	○	○	○	○	○	○	○	○	○



PLAIN SHANK SEME36 SERIES

CARBIDE, 4 FLUTE MULTIPLE HELIX

- VOLLHARTMETALL, 4 SCHNEIDEN MEHRSPIRAL
- Fraise carbure, 4 dents, hélice multiple
- MD, 4 TAGLIENTI, SPIGOLO VIVO

▶ New coating and tool geometry applied resulting outstanding cutting abilities and wear resistance.
 ▶ Excellent for cutting prehardened steels, carbon steels, alloy steels of molds and dies, up to HRC55 and machine parts.
 ▶ Multiple Helix for 3.0mm and over 3.0mm diameter end mills minimizing vibration and decreasing wear in cutting.

▶ Aufgrund einer neuartigen Beschichtung und neuer Werkzeuggeometrien hervorragende Schnittleistung und Verschleißfestigkeit
 ▶ Ausgezeichnet geeignet für das Fräsen von vorvergütetem Stahl, kohlenstoff Stahl, legiertem Stahl für Formen, bis HRC55 und Maschinenbauteile.
 ▶ Aufgrund der Multi-Helix (M-Helix) bei Schauffräsern ≥ 3,0mm ø werden Vibrationen zuverlässig verhindert und gleichzeitig der Schneidkantenverschleiß verringert.

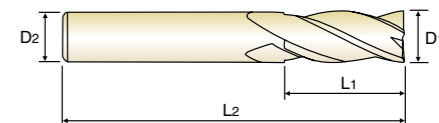

Flat Shank	Page	Plain Shank	Page
END MILL HOLDER	D118-137	HYDRAULIC CHUCK SHRINK FIT HOLDER	D15-46 D47-72
-	-	POWER MILLING CHUCK	D161-176
-	-	ER COLLET CHUCK SK SLIM CHUCK	D73-116 D183-201

D<ø3, 30° HELIX

Unit : mm

EDP No.	Mill Diameter	Shank Diameter	Length of Cut	Overall Length	Remark
	D1	D2	L1	L2	
★ SEME36090E	9.0	10	22	70	-
★ SEME36095E	9.5	10	24	70	-
★ SEME36100E	10.0	10	25	75	-
SEME36105E	10.5	12	26	75	-
★ SEME36110E	11.0	12	30	75	-
SEME36115E	11.5	12	30	80	-
★ SEME36120E	12.0	12	30	80	-
SEME36130E	13.0	12	35	100	-
SEME3614012SE	14.0	12	35	100	-
★ SEME3614014SE	14.0	14	35	100	-
★ SEME36140E	14.0	16	35	100	-
SEME36150E	15.0	16	38	100	-
★ SEME36160E	16.0	16	40	100	-
SEME36170E	17.0	16	42	100	-
★ SEME36180E	18.0	16	45	100	-
★ SEME3618018SE	18.0	18	45	100	-
SEME36190E	19.0	20	45	100	-
★ SEME36200E	20.0	20	45	100	-
SEME36210E	21.0	20	45	100	-
SEME36220E	22.0	20	45	100	-
SEME36230E	23.0	25	50	120	-
SEME36240E	24.0	25	50	120	-
SEME36250E	25.0	25	50	120	-

★ : Stock Item

Mill Dia. Tolerance (mm)	Shank Dia. Tolerance
0 ~ - 0.03	h5

◎ : Excellent ○ : Good

ISO Material Description	P										M						K				
	Non-alloy steel					Low alloy steel					High alloyed steel, and tool steel		Stainless steel				Grey cast iron		Nodular cast iron	Malleable cast iron	
VDI 3323	1	2	3	4	5	6	7	8	9	10	11	12	13	14	15	16	17	18	19	20	
HRc	13	25	28	32	30	10	29	32	38	15	35	15	23	10	10	26	3	25	21	21	
HB	125	190	250	270	300	180	275	300	350	200	325	200	240	180	180	260	160	250	130	230	
Recommend	○	○	◎	◎	◎	○	◎	◎	◎	◎	◎	○	○	○	○	○	○	○	○	○	○



PLAIN SHANK SEME71 SERIES

CARBIDE, 4 FLUTE MULTIPLE HELIX (Sharp corner removal)

- VOLLHARTMETALL, 4 SCHNEIDEN MEHRSPIRAL (Scharfe Schneidenecken entfernt)
- Fraise carbure, 4 dents, hélice multiple (Protection de l'angle d'attaque)
- MD, 4 TAGLIENTI, TAGLIENTE RINFORZATO

- ▶ New coating and tool geometry applied resulting outstanding cutting abilities and wear resistance.
- ▶ Excellent for cutting prehardened steels, carbon steels, alloy steels of molds and dies, up to HRC55 and machine parts.
- ▶ Multiple Helix for 3.0mm and over 3.0mm diameter endmills minimizing vibration and decreasing wear in cutting.
 - Equal index flutes design for long length and single helix (38°) end mills.
- ▶ Gash land geometry applied at the end tooth, achieving heavy duty cutting.
- ▶ Available various length products like short, regular and long length end mills etc.
- ▶ Available in short, regular and long shank end mills.

- ▶ Aufgrund einer neuartigen Beschichtung und neuer Werkzeuggeometrien hervorragende Schnittleistung und Verschleißfestigkeit
- ▶ Ausgezeichnet geeignet für das Fräsen von vorvergütetem Stahl, kohlenstoff Stahl, legiertem Stahl für Formen, bis HRC55 und Maschinenbauteile.
- ▶ Aufgrund der Multi-Helix (M-Helix) bei Schaffräsern ≥ 3,0mm ø werden Vibrationen zuverlässig verhindert und gleichzeitig der Schneidkantenverschleiß verringert.
 - Designed mit gleichgeteilten Spannuten für überlange Schaffräser.
- ▶ Aufgrund der korrigierten Stirnschneiden ist eine Schwerzerspannung möglich.
- ▶ Erhältlich in verschiedenen Variationen: kurz, lang und extra lang.



Flat Shank	Page	Plain Shank	Page
END MILL HOLDER	D118-137	HYDRAULIC CHUCK SHRINK FIT HOLDER	D15-46 D47-72
-	-	POWER MILLING CHUCK	D161-176
-	-	ER COLLET CHUCK SK SLIM CHUCK	D73-116 D183-201

D<Ø3, Long Length 38° HELIX

Unit : mm

EDP No.	Mill Diameter	Shank Diameter	Length of Cut	Overall Length	Remark
	D1	D2	L1	L2	
SEME71010014SE	1.0	4	1	40	4mm Shank
SEME71010024SE	1.0	4	2	40	4mm Shank
SEME710104SE	1.0	4	2.5	50	4mm Shank
SEME71010034SE	1.0	4	3	50	4mm Shank
SEME71010044SE	1.0	4	4	50	4mm Shank
SEME71010064SE	1.0	4	6	50	4mm Shank
SEME7101001E	1.0	6	1	40	Short
SEME7101002E	1.0	6	2	40	Short
★ SEME71010E	1.0	6	2.5	50	Regular
SEME7101003E	1.0	6	3	50	Long
SEME7101004E	1.0	6	4	50	Long
SEME7101006E	1.0	6	6	50	Long
SEME71012024SE	1.2	4	2	40	4mm Shank
SEME710124SE	1.2	4	3	50	4mm Shank
SEME71012044SE	1.2	4	4	50	4mm Shank
SEME71012064SE	1.2	4	6	50	4mm Shank
SEME7101202E	1.2	6	2	40	Short
★ SEME71012E	1.2	6	3	50	Regular
SEME7101204E	1.2	6	4	50	Long
SEME7101206E	1.2	6	6	50	Long
SEME710150154SE	1.5	4	1.5	40	4mm Shank
SEME71015034SE	1.5	4	3	40	4mm Shank
SEME710154SE	1.5	4	4	50	4mm Shank
SEME71015064SE	1.5	4	6	50	4mm Shank

★ : Stock Item

▶ NEXT PAGE

Mill Dia. Tolerance (mm)	Shank Dia. Tolerance
0 ~ -0.03	h5



◎ : Excellent ○ : Good

ISO	P										M						K			
	Non-alloy steel					Low alloy steel					High alloyed steel, and tool steel		Stainless steel		Grey cast iron	Nodular cast iron		Malleable cast iron		
Material Description	1	2	3	4	5	6	7	8	9	10	11	12	13	14	15	16	17	18	19	20
VDI 3323	1	2	3	4	5	6	7	8	9	10	11	12	13	14	15	16	17	18	19	20
HRc	13	25	28	32	30	29	32	38	35	35	15	23	10	10	26	3	25	21		
HB	125	190	250	270	300	180	275	300	350	200	325	200	240	180	180	260	160	250	130	230
Recommend	○	○	◎	◎	◎	○	◎	◎	◎	◎	◎	○	○	○	○	○	○	○	○	○



PLAIN SHANK SEME71 SERIES

CARBIDE, 4 FLUTE MULTIPLE HELIX (Sharp corner removal)

- VOLLHARTMETALL, 4 SCHNEIDEN MEHRSPIRAL (Scharfe Schneidenecken entfernt)
- Fraise carbure, 4 dents, hélice multiple (Protection de l'angle d'attaque)
- MD, 4 TAGLIENTI, TAGLIENTE RINFORZATO

- ▶ New coating and tool geometry applied resulting outstanding cutting abilities and wear resistance.
- ▶ Excellent for cutting prehardened steels, carbon steels, alloy steels of molds and dies, up to HRC55 and machine parts.
- ▶ Multiple Helix for 3.0mm and over 3.0mm diameter endmills minimizing vibration and decreasing wear in cutting.
 - Equal index flutes design for long length and single helix (38°) end mills.
- ▶ Gash land geometry applied at the end tooth, achieving heavy duty cutting.
- ▶ Available various length products like short, regular and long length end mills etc.
- ▶ Available in short, regular and long shank end mills.

- ▶ Aufgrund einer neuartigen Beschichtung und neuer Werkzeuggeometrien hervorragende Schnittleistung und Verschleißfestigkeit
- ▶ Ausgezeichnet geeignet für das Fräsen von vorvergütetem Stahl, kohlenstoff Stahl, legiertem Stahl für Formen, bis HRC55 und Maschinenbauteile.
- ▶ Aufgrund der Multi-Helix (M-Helix) bei Schaffräsern ≥ 3,0mm ø werden Vibrationen zuverlässig verhindert und gleichzeitig der Schneidkantenverschleiß verringert.
 - Designed mit gleichgeteilten Spannuten für überlange Schaffräser.
- ▶ Aufgrund der korrigierten Stirnschneiden ist eine Schwerzerspannung möglich.
- ▶ Erhältlich in verschiedenen Variationen: kurz, lang und extra lang.



Flat Shank	Page	Plain Shank	Page
END MILL HOLDER	D118-137	HYDRAULIC CHUCK SHRINK FIT HOLDER	D15-46 D47-72
-	-	POWER MILLING CHUCK	D161-176
-	-	ER COLLET CHUCK SK SLIM CHUCK	D73-116 D183-201

D<Ø3, Long Length 38° HELIX

Unit : mm

EDP No.	Mill Diameter	Shank Diameter	Length of Cut	Overall Length	Remark
	D1	D2	L1	L2	
SEME71015084SE	1.5	4	8	50	4mm Shank
SEME71015104SE	1.5	4	10	50	4mm Shank
SEME71015015E	1.5	6	1.5	40	Short
SEME7101503E	1.5	6	3	40	Short
★ SEME71015E	1.5	6	4	50	Regular
SEME7101506E	1.5	6	6	50	Long
SEME7101508E	1.5	6	8	50	Long
SEME7101510E	1.5	6	10	50	Long
SEME71020024SE	2.0	4	2	40	4mm Shank
SEME71020044SE	2.0	4	4	40	4mm Shank
SEME710204SE	2.0	4	6	50	4mm Shank
SEME71020084SE	2.0	4	8	50	4mm Shank
SEME71020104SE	2.0	4	10	50	4mm Shank
SEME71020124SE	2.0	4	12	50	4mm Shank
SEME7102002E	2.0	6	2	40	Short
SEME7102004E	2.0	6	4	40	Short
★ SEME71020E	2.0	6	6	50	Regular
SEME7102008E	2.0	6	8	50	Long
SEME7102010E	2.0	6	10	50	Long
SEME7102012E	2.0	6	12	50	Long
SEME710250254SE	2.5	4	2.5	40	4mm Shank
SEME71025054SE	2.5	4	5	40	4mm Shank
SEME710254SE	2.5	4	7	50	4mm Shank
SEME71025104SE	2.5	4	10	50	4mm Shank

★ : Stock Item

▶ NEXT PAGE

Mill Dia. Tolerance (mm)	Shank Dia. Tolerance
0 ~ -0.03	h5



◎ : Excellent ○ : Good

ISO	P										M						K			
	Non-alloy steel					Low alloy steel					High alloyed steel, and tool steel		Stainless steel		Grey cast iron	Nodular cast iron		Malleable cast iron		
Material Description	1	2	3	4	5	6	7	8	9	10	11	12	13	14	15	16	17	18	19	20
VDI 3323	1	2	3	4	5	6	7	8	9	10	11	12	13	14	15	16	17	18	19	20
HRc	13	25	28	32	30	29	32	38	35	35	15	23	10	10	26	3	25	21		
HB	125	190	250	270	300	180	275	300	350	200	325	200	240	180	180	260	160	250	130	230
Recommend	○	○	◎	◎	◎	○	◎	◎	◎	◎	◎	○	○	○	○	○	○	○	○	○

HSS

HSS



PLAIN SHANK SEME71 SERIES



PLAIN SHANK SEME71 SERIES

CARBIDE, 4 FLUTE MULTIPLE HELIX (Sharp corner removal)

CARBIDE, 4 FLUTE MULTIPLE HELIX (Sharp corner removal)

- VOLLHARTMETALL, 4 SCHNEIDEN MEHRSPIRAL (Scharfe Schneidenecken entfernt)
Fraise carbure, 4 dents, hélice multiple (Protection de l'angle d'attaque)
MD, 4 TAGLIENTI, TAGLIENTE RINFORZATO

- VOLLHARTMETALL, 4 SCHNEIDEN MEHRSPIRAL (Scharfe Schneidenecken entfernt)
Fraise carbure, 4 dents, hélice multiple (Protection de l'angle d'attaque)
MD, 4 TAGLIENTI, TAGLIENTE RINFORZATO

- New coating and tool geometry applied resulting outstanding cutting abilities and wear resistance.
Excellent for cutting prehardened steels, carbon steels, alloy steels of molds and dies, up to HRC55 and machine parts.
Multiple Helix for 3.0mm and over 3.0mm diameter endmills minimizing vibration and decreasing wear in cutting.
Gash land geometry applied at the end tooth, achieving heavy duty cutting.
Available in short, regular and long shank end mills.

- New coating and tool geometry applied resulting outstanding cutting abilities and wear resistance.
Excellent for cutting prehardened steels, carbon steels, alloy steels of molds and dies, up to HRC55 and machine parts.
Multiple Helix for 3.0mm and over 3.0mm diameter endmills minimizing vibration and decreasing wear in cutting.
Gash land geometry applied at the end tooth, achieving heavy duty cutting.
Available in short, regular and long shank end mills.



Table with 2 columns: Flat Shank and Plain Shank. Rows include END MILL HOLDER, HYDRAULIC CHUCK, POWER MILLING CHUCK, ER COLLET CHUCK.

Table with 2 columns: Flat Shank and Plain Shank. Rows include END MILL HOLDER, HYDRAULIC CHUCK, POWER MILLING CHUCK, ER COLLET CHUCK.

D<Ø3, Long Length 38° HELIX

D<Ø3, Long Length 38° HELIX

Unit : mm

Unit : mm

Main product table with columns: EDP No., Mill Diameter, Shank Diameter, Length of Cut, Overall Length, Remark. Lists various SEME71 models.

Main product table with columns: EDP No., Mill Diameter, Shank Diameter, Length of Cut, Overall Length, Remark. Lists various SEME71 models.

* : Stock Item

* : Stock Item

Table with 2 columns: Mill Dia. Tolerance (mm), Shank Dia. Tolerance. Values: 0 ~ - 0.03, h5

Table with 2 columns: Mill Dia. Tolerance (mm), Shank Dia. Tolerance. Values: 0 ~ - 0.03, h5



◎ : Excellent ○ : Good

◎ : Excellent ○ : Good

ISO material compatibility table with columns for P, M, K, N, S, H and rows for Material Description, VDI 3323, HRc, HB, Recommend.

ISO material compatibility table with columns for P, M, K, N, S, H and rows for Material Description, VDI 3323, HRc, HB, Recommend.



PLAIN SHANK SEME72 SERIES

CARBIDE, 4 FLUTE LONG LENGTH

- VOLLHARTMETALL, 4 SCHNEIDEN LANG
- (●) Fraise carbure, 4 dents, longue
- (●) MD, 4 TAGLIENTI, SPIGOLO VIVO, SERIE LUNGA

- ▶ New coating and tool geometry applied resulting outstanding cutting abilities and wear resistance.
- ▶ Excellent for cutting prehardened steels, carbon steels, alloy steels of molds and dies, up to HRC55 and machine parts.
- ▶ Available in short, regular and long shank end mills.

- ▶ Aufgrund einer neuartigen Beschichtung und neuer Werkzeuggeometrien hervorragende Schnittleistung und Verschleißfestigkeit
- ▶ Hervorragende Leistung bei der Zerspaltung von vorvergüteten Stählen bis HRC55, welche im Werkzeug- und Formenbau Verwendung finden.
- ▶ Erhältlich in verschiebenen Schneiden- und Gesamtlängen.

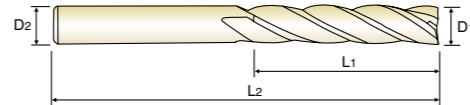

CARBIDE 4 30° PLAIN Coating p.C314-319

Flat Shank	Page	Plain Shank	Page
END MILL HOLDER	D118-137	HYDRAULIC CHUCK SHRINK FIT HOLDER	D15-46 D47-72
-	-	POWER MILLING CHUCK	D161-176
-	-	ER COLLET CHUCK SK SLIM CHUCK	D73-116 D183-201

Unit : mm

EDP No.	Mill Diameter	Shank Diameter	Length of Cut	Overall Length
	D1	D2	L1	L2
★ SEME7201003E	1.0	6	3	60
★ SEME7201004E	1.0	6	4	60
★ SEME7201005E	1.0	6	5	60
★ SEME7201006E	1.0	6	6	60
SEME7201007E	1.0	6	7	60
★ SEME7201008E	1.0	6	8	60
SEME7201010E	1.0	6	10	60
SEME7201012E	1.0	6	12	60
SEME7201204E	1.2	6	4	60
SEME7201206E	1.2	6	6	60
SEME7201208E	1.2	6	8	60
SEME7201210E	1.2	6	10	60
SEME7201212E	1.2	6	12	60
★ SEME7201506E	1.5	6	6	60
★ SEME7201508E	1.5	6	8	60
SEME7201510E	1.5	6	10	60
SEME7201512E	1.5	6	12	60
SEME7201514E	1.5	6	14	60
SEME7201516E	1.5	6	16	60
★ SEME7202008E	2.0	6	8	60
★ SEME7202010E	2.0	6	10	60
★ SEME7202012E	2.0	6	12	60
★ SEME7202014E	2.0	6	14	60
★ SEME7202016E	2.0	6	16	60

★ : Stock Item ▶ NEXT PAGE

Mill Dia. Tolerance (mm)	Shank Dia. Tolerance
0 ~ -0.03	h5

◎ : Excellent ○ : Good

ISO Material Description	P										M				K						
	Non-alloy steel					Low alloy steel					High alloyed steel, and tool steel		Stainless steel		Grey cast iron	Nodular cast iron		Malleable cast iron			
VDI 3323	1	2	3	4	5	6	7	8	9	10	11	12	13	14	15	16	17	18	19	20	
HRc	13	25	28	32	30	10	29	32	38	15	35	15	23	10	10	26	3	25	21	21	
HB	125	190	250	270	300	180	275	300	350	200	325	200	240	180	180	260	160	250	130	230	
Recommend	○	○	◎	◎	◎	○	◎	◎	◎	◎	◎	○	○	○	○	○	○	○	○	○	○

ISO Material Description	N					S					H											
	Aluminum-wrought alloy		Aluminum-cast, alloyed			Copper and Copper Alloys (Bronze / Brass)			Non Metallic Materials		Heat Resistant Super Alloys			Titanium Alloys	Hardened steel	Chilled Cast Iron	Hardened Cast Iron					
VDI 3323	21	22	23	24	25	26	27	28	29	30	31	32	33	34	35	36	37	38	39	40	41	
HRc	21	22	23	24	25	26	27	28	29	30	15	30	25	38	34	400 Rm	1050 Rm	55	60	42	55	
HB	60	100	75	90	130	110	90	100			200	280	250	350	320	400 Rm	1050 Rm	550	630	400	550	
Recommend	○	○	○	○	○	○	○	○	○	○	○	○	○	○	○	○	○	○	○	○	○	○



PLAIN SHANK SEME72 SERIES

CARBIDE, 4 FLUTE LONG LENGTH

- VOLLHARTMETALL, 4 SCHNEIDEN LANG
- (●) Fraise carbure, 4 dents, longue
- (●) MD, 4 TAGLIENTI, SPIGOLO VIVO, SERIE LUNGA

- ▶ New coating and tool geometry applied resulting outstanding cutting abilities and wear resistance.
- ▶ Excellent for cutting prehardened steels, carbon steels, alloy steels of molds and dies, up to HRC55 and machine parts.
- ▶ Available in short, regular and long shank end mills.

- ▶ Aufgrund einer neuartigen Beschichtung und neuer Werkzeuggeometrien hervorragende Schnittleistung und Verschleißfestigkeit
- ▶ Hervorragende Leistung bei der Zerspaltung von vorvergüteten Stählen bis HRC55, welche im Werkzeug- und Formenbau Verwendung finden.
- ▶ Erhältlich in verschiebenen Schneiden- und Gesamtlängen.

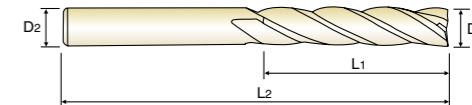

CARBIDE 4 30° PLAIN Coating p.C314-319

Flat Shank	Page	Plain Shank	Page
END MILL HOLDER	D118-137	HYDRAULIC CHUCK SHRINK FIT HOLDER	D15-46 D47-72
-	-	POWER MILLING CHUCK	D161-176
-	-	ER COLLET CHUCK SK SLIM CHUCK	D73-116 D183-201

Unit : mm

EDP No.	Mill Diameter	Shank Diameter	Length of Cut	Overall Length
	D1	D2	L1	L2
★ SEME7202510E	2.5	6	10	60
★ SEME7202512E	2.5	6	12	60
SEME7202516E	2.5	6	16	60
SEME7202520E	2.5	6	20	60
SEME7202526E	2.5	6	26	60
SEME72030163SE	3.0	3	16	100
★ SEME7203010E	3.0	6	10	70
★ SEME7203012E	3.0	6	12	70
★ SEME7203014E	3.0	6	14	70
★ SEME7203016E	3.0	6	16	70
★ SEME7203020E	3.0	6	20	70
★ SEME7203026E	3.0	6	26	70
★ SEME7203030E	3.0	6	30	70
★ SEME72040204SE	4.0	4	20	100
★ SEME7204012E	4.0	6	12	70
★ SEME7204016E	4.0	6	16	70
★ SEME7204020E	4.0	6	20	70
★ SEME7204026E	4.0	6	26	70
★ SEME7204030E	4.0	6	30	70
★ SEME7205020E	5.0	6	20	70
★ SEME7205025E	5.0	6	25	70
★ SEME7205025100E	5.0	6	25	100
★ SEME7205030E	5.0	6	30	80
★ SEME7205035E	5.0	6	35	90

★ : Stock Item ▶ NEXT PAGE

Mill Dia. Tolerance (mm)	Shank Dia. Tolerance
0 ~ -0.03	h5

◎ : Excellent ○ : Good

ISO Material Description	P										M				K						
	Non-alloy steel					Low alloy steel					High alloyed steel, and tool steel		Stainless steel		Grey cast iron	Nodular cast iron		Malleable cast iron			
VDI 3323	1	2	3	4	5	6	7	8	9	10	11	12	13	14	15	16	17	18	19	20	
HRc	13	25	28	32	30	10	29	32	38	15	35	15	23	10	10	26	3	25	21	21	
HB	125	190	250	270	300	180	275	300	350	200	325	200	240	180	180	260	160	250	130	230	
Recommend	○	○	◎	◎	◎	○	◎	◎	◎	◎	◎	○	○	○	○	○	○	○	○	○	○

ISO Material Description	N					S					H											
	Aluminum-wrought alloy		Aluminum-cast, alloyed			Copper and Copper Alloys (Bronze / Brass)			Non Metallic Materials		Heat Resistant Super Alloys			Titanium Alloys	Hardened steel	Chilled Cast Iron	Hardened Cast Iron					
VDI 3323	21	22	23	24	25	26	27	28	29	30	31	32	33	34	35	36	37	38	39	40	41	
HRc	21	22	23	24	25	26	27	28	29	30	15	30	25	38	34	400 Rm	1050 Rm	55	60	42	55	
HB	60	100	75	90	130	110	90	100			200	280	250	350	320	400 Rm	1050 Rm	550	630	400	550	
Recommend	○	○	○	○	○	○	○	○	○	○	○	○	○	○	○	○	○	○	○	○	○	○

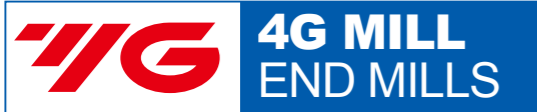

PLAIN SHANK SEME72 SERIES

CARBIDE, 4 FLUTE LONG LENGTH

- VOLLHARTMETALL, 4 SCHNEIDEN LANG
- (●) Fraise carbure, 4 dents, longue
- (●) MD, 4 TAGLIENTI, SPIGOLO VIVO, SERIE LUNGA

- ▶ New coating and tool geometry applied resulting outstanding cutting abilities and wear resistance.
- ▶ Excellent for cutting prehardened steels, carbon steels, alloy steels of molds and dies, up to HRC55 and machine parts.
- ▶ Available in short, regular and long shank end mills.

- ▶ Aufgrund einer neuartigen Beschichtung und neuer Werkzeuggeometrien hervorragende Schnittleistung und Verschleißfestigkeit
- ▶ Hervorragende Leistung bei der Zerspaltung von vorvergüteten Stählen bis HRC55, welche im Werkzeug- und Formenbau Verwendung finden.
- ▶ Erhältlich in verschiebenen Schneiden- und Gesamtlängen.

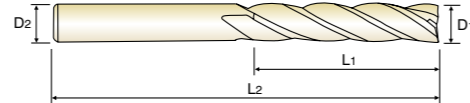

CARBIDE 4 30° PLAIN Coating p.C314-319

Flat Shank	Page	Plain Shank	Page
END MILL HOLDER	D118-137	HYDRAULIC CHUCK SHRINK FIT HOLDER	D15-46 D47-72
-	-	POWER MILLING CHUCK	D161-176
-	-	ER COLLET CHUCK SK SLIM CHUCK	D73-116 D183-201

Unit : mm

EDP No.	Mill Diameter	Shank Diameter	Length of Cut	Overall Length
	D1	D2	L1	L2
★ SEME7205040E	5.0	6	40	100
★ SEME7206015E	6.0	6	15	60
★ SEME7206015080E	6.0	6	15	80
★ SEME7206020E	6.0	6	20	70
★ SEME7206020090E	6.0	6	20	90
★ SEME7206025E	6.0	6	25	75
★ SEME7206030E	6.0	6	30	80
★ SEME7206030100E	6.0	6	30	100
★ SEME7206030150E	6.0	6	30	150
★ SEME7206035E	6.0	6	35	90
★ SEME7206040E	6.0	6	40	90
★ SEME7206040120E	6.0	6	40	120
★ SEME7206045E	6.0	6	45	150
★ SEME7208025E	8.0	8	25	80
★ SEME7208030E	8.0	8	30	80
★ SEME7208030100E	8.0	8	30	100
★ SEME7208035E	8.0	8	35	90
★ SEME7208040E	8.0	8	40	90
★ SEME7208040120E	8.0	8	40	120
★ SEME7208040150E	8.0	8	40	150
★ SEME7208045E	8.0	8	45	100
★ SEME7208050E	8.0	8	50	100
★ SEME7208050150E	8.0	8	50	150
★ SEME7210030E	10.0	10	30	80

★ : Stock Item ▶ NEXT PAGE

Mill Dia. Tolerance (mm)	Shank Dia. Tolerance
0 ~ - 0.03	h5

◎ : Excellent ○ : Good

ISO Material Description	P										M						K																								
	Non-alloy steel					Low alloy steel					High alloyed steel, and tool steel		Stainless steel				Grey cast iron		Nodular cast iron		Malleable cast iron																				
VDI 3323	1	2	3	4	5	6	7	8	9	10	11	12	13	14	15	16	17	18	19	20	21	22	23	24	25	26	27	28	29	30	31	32	33	34	35	36	37	38	39	40	41
HRc	13	25	28	32	30	10	29	32	38	15	35	15	23	10	10	26	3	25	21	21	15	30	25	38	34	200	325	200	240	180	180	260	160	250	130	230					
HB	125	190	250	270	300	180	275	300	350	200	325	200	240	180	180	260	160	250	130	230	125	190	250	270	300	180	275	300	350	200	325	200	240	180	180	260	160	250	130	230	
Recommend	○	○	◎	◎	◎	○	◎	◎	◎	◎	◎	○	○	○	○	○	○	○	○	○	○	○	◎	◎	◎	◎	◎	◎	◎	◎	◎	◎	◎	◎	◎	◎	◎	◎	◎	◎	◎



PLAIN SHANK SEME72 SERIES

CARBIDE, 4 FLUTE LONG LENGTH

- VOLLHARTMETALL, 4 SCHNEIDEN LANG
- (●) Fraise carbure, 4 dents, longue
- (●) MD, 4 TAGLIENTI, SPIGOLO VIVO, SERIE LUNGA

- ▶ New coating and tool geometry applied resulting outstanding cutting abilities and wear resistance.
- ▶ Excellent for cutting prehardened steels, carbon steels, alloy steels of molds and dies, up to HRC55 and machine parts.
- ▶ Available in short, regular and long shank end mills.

- ▶ Aufgrund einer neuartigen Beschichtung und neuer Werkzeuggeometrien hervorragende Schnittleistung und Verschleißfestigkeit
- ▶ Hervorragende Leistung bei der Zerspaltung von vorvergüteten Stählen bis HRC55, welche im Werkzeug- und Formenbau Verwendung finden.
- ▶ Erhältlich in verschiebenen Schneiden- und Gesamtlängen.

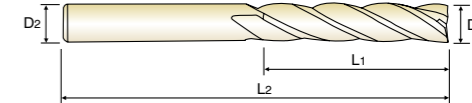

CARBIDE 4 30° PLAIN Coating p.C314-319

Flat Shank	Page	Plain Shank	Page
END MILL HOLDER	D118-137	HYDRAULIC CHUCK SHRINK FIT HOLDER	D15-46 D47-72
-	-	POWER MILLING CHUCK	D161-176
-	-	ER COLLET CHUCK SK SLIM CHUCK	D73-116 D183-201

Unit : mm

EDP No.	Mill Diameter	Shank Diameter	Length of Cut	Overall Length
	D1	D2	L1	L2
★ SEME7210030100E	10.0	10	30	100
★ SEME7210035E	10.0	10	35	90
★ SEME7210040E	10.0	10	40	90
★ SEME7210040120E	10.0	10	40	120
★ SEME7210045E	10.0	10	45	100
★ SEME7210050E	10.0	10	50	100
★ SEME7210050150E	10.0	10	50	150
★ SEME7210050200E	10.0	10	50	200
★ SEME7210055E	10.0	10	55	150
★ SEME7210060E	10.0	10	60	110
★ SEME7210060200E	10.0	10	60	200
★ SEME7212035E	12.0	12	35	90
★ SEME7212040E	12.0	12	40	100
★ SEME7212040120E	12.0	12	40	120
★ SEME7212045E	12.0	12	45	130
★ SEME7212050E	12.0	12	50	100
★ SEME7212050150E	12.0	12	50	150
★ SEME7212055E	12.0	12	55	110
★ SEME7212060E	12.0	12	60	110
★ SEME7212060150E	12.0	12	60	150
★ SEME7212060200E	12.0	12	60	200
★ SEME7212065E	12.0	12	65	150
★ SEME7212070E	12.0	12	70	120
★ SEME7212070200E	12.0	12	70	200

★ : Stock Item ▶ NEXT PAGE

Mill Dia. Tolerance (mm)	Shank Dia. Tolerance
0 ~ - 0.03	h5

◎ : Excellent ○ : Good

ISO Material Description	P										M						K																								
	Non-alloy steel					Low alloy steel					High alloyed steel, and tool steel		Stainless steel				Grey cast iron		Nodular cast iron		Malleable cast iron																				
VDI 3323	1	2	3	4	5	6	7	8	9	10	11	12	13	14	15	16	17	18	19	20	21	22	23	24	25	26	27	28	29	30	31	32	33	34	35	36	37	38	39	40	41
HRc	13	25	28	32	30	10	29	32	38	15	35	15	23	10	10	26	3	25	21	21	15	30	25	38	34	200	325	200	240	180	180	260	160	250	130	230					
HB	125	190	250	270	300	180	275	300	350	200	325	200	240	180	180	260	160	250	130	230	125	190	250	270	300	180	275	300	350	200	325	200	240	180	180	260	160	250	130	230	
Recommend	○	○	◎	◎	◎	○	◎	◎	◎	◎	◎	○	○	○	○	○	○	○	○	○	○	○	◎	◎	◎	◎	◎	◎	◎	◎	◎	◎	◎	◎	◎	◎	◎	◎	◎	◎	◎

CARBIDE, 4 FLUTE LONG LENGTH

- VOLLHARTMETALL, 4 SCHNEIDEN LANG
- (●) Fraise carbure, 4 dents, longue
- (●) MD, 4 TAGLIENTI, SPIGOLO VIVO, SERIE LUNGA

- ▶ New coating and tool geometry applied resulting outstanding cutting abilities and wear resistance.
- ▶ Excellent for cutting prehardened steels, carbon steels, alloy steels of molds and dies, up to HRC55 and machine parts.
- ▶ Available in short, regular and long shank end mills.

- ▶ Aufgrund einer neuartigen Beschichtung und neuer Werkzeuggeometrien hervorragende Schnittleistung und Verschleißfestigkeit
- ▶ Hervorragende Leistung bei der Zerspaltung von vorvergüteten Stählen bis HRC55, welche im Werkzeug- und Formenbau Verwendung finden.
- ▶ Erhältlich in verschiebenen Schneiden- und Gesamtlängen.

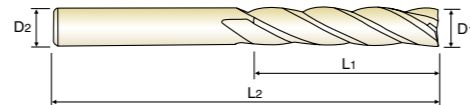

CARBIDE 4 30° PLAIN Coating p.C314-319

Flat Shank	Page	Plain Shank	Page
END MILL HOLDER	D118-137	HYDRAULIC CHUCK SHRINK FIT HOLDER	D15-46 D47-72
-	-	POWER MILLING CHUCK	D161-176
-	-	ER COLLET CHUCK SK SLIM CHUCK	D73-116 D183-201

Unit : mm

EDP No.	Mill Diameter	Shank Diameter	Length of Cut	Overall Length
	D1	D2	L1	L2
★ SEME7214050E	14.0	16	50	110
★ SEME7214060E	14.0	16	60	150
SEME7216040E	16.0	16	40	150
★ SEME7216050E	16.0	16	50	110
SEME7216050150E	16.0	16	50	150
★ SEME7216060E	16.0	16	60	120
★ SEME7216070E	16.0	16	70	130
★ SEME7216070150E	16.0	16	70	150
SEME7216070200E	16.0	16	70	200
SEME7216080E	16.0	16	80	150
SEME7216090E	16.0	16	90	150
SEME72160110E	16.0	16	110	200
SEME72160120E	16.0	16	120	250
SEME7218050E	18.0	20	50	120
SEME7218070E	18.0	20	70	130
SEME72180100E	18.0	20	100	200
★ SEME7220050E	20.0	20	50	110
SEME7220050150E	20.0	20	50	150
★ SEME7220060E	20.0	20	60	130
★ SEME7220070E	20.0	20	70	130
SEME7220080E	20.0	20	80	150
★ SEME7220090E	20.0	20	90	150
★ SEME7220090200E	20.0	20	90	200
SEME72200110E	20.0	20	110	200

★ : Stock Item

▶ NEXT PAGE

Mill Dia. Tolerance (mm)	Shank Dia. Tolerance
0 ~ - 0.03	h5

◎ : Excellent ○ : Good

ISO Material Description	P										M				K						
	Non-alloy steel					Low alloy steel					High alloyed steel, and tool steel		Stainless steel		Grey cast iron		Nodular cast iron		Malleable cast iron		
VDI 3323	1	2	3	4	5	6	7	8	9	10	11	12	13	14	15	16	17	18	19	20	
HRc	13	25	28	32	30	10	29	32	38	15	35	15	23	10	10	26	3	25	21	21	
HB	125	190	250	270	300	180	275	300	350	200	325	200	240	180	180	260	160	250	130	230	
Recommend	○	○	◎	◎	◎	○	◎	◎	◎	◎	◎	○	○	○	○	○	○	○	○	○	○

CARBIDE, 4 FLUTE LONG LENGTH

- VOLLHARTMETALL, 4 SCHNEIDEN LANG
- (●) Fraise carbure, 4 dents, longue
- (●) MD, 4 TAGLIENTI, SPIGOLO VIVO, SERIE LUNGA

- ▶ New coating and tool geometry applied resulting outstanding cutting abilities and wear resistance.
- ▶ Excellent for cutting prehardened steels, carbon steels, alloy steels of molds and dies, up to HRC55 and machine parts.
- ▶ Available in short, regular and long shank end mills.

- ▶ Aufgrund einer neuartigen Beschichtung und neuer Werkzeuggeometrien hervorragende Schnittleistung und Verschleißfestigkeit
- ▶ Hervorragende Leistung bei der Zerspaltung von vorvergüteten Stählen bis HRC55, welche im Werkzeug- und Formenbau Verwendung finden.
- ▶ Erhältlich in verschiebenen Schneiden- und Gesamtlängen.

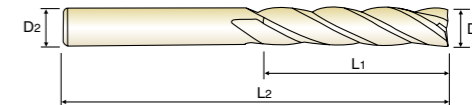

CARBIDE 4 30° PLAIN Coating p.C314-319

Flat Shank	Page	Plain Shank	Page
END MILL HOLDER	D118-137	HYDRAULIC CHUCK SHRINK FIT HOLDER	D15-46 D47-72
-	-	POWER MILLING CHUCK	D161-176
-	-	ER COLLET CHUCK SK SLIM CHUCK	D73-116 D183-201

Unit : mm

EDP No.	Mill Diameter	Shank Diameter	Length of Cut	Overall Length
	D1	D2	L1	L2
★ SEME72200120E	20.0	20	120	250
SEME7222075E	22.0	20	75	150
SEME72220110E	22.0	20	110	200
SEME7225070E	25.0	25	70	150
★ SEME7225090E	25.0	25	90	150
SEME72250110E	25.0	25	110	200
SEME72250120E	25.0	25	120	250

★ : Stock Item

Mill Dia. Tolerance (mm)	Shank Dia. Tolerance
0 ~ - 0.03	h5

◎ : Excellent ○ : Good

ISO Material Description	P										M				K						
	Non-alloy steel					Low alloy steel					High alloyed steel, and tool steel		Stainless steel		Grey cast iron		Nodular cast iron		Malleable cast iron		
VDI 3323	1	2	3	4	5	6	7	8	9	10	11	12	13	14	15	16	17	18	19	20	
HRc	13	25	28	32	30	10	29	32	38	15	35	15	23	10	10	26	3	25	21	21	
HB	125	190	250	270	300	180	275	300	350	200	325	200	240	180	180	260	160	250	130	230	
Recommend	○	○	◎	◎	◎	○	◎	◎	◎	◎	◎	○	○	○	○	○	○	○	○	○	○

CARBIDE, 4 FLUTE with EXTENDED NECK

- VOLLHARTMETALL, 4 SCHNEIDEN mit ABGESETZTEM SCHAFTTETL
- Fraise carbure, 4 dents, détalonnée
- MD, 4 TAGLIENTI, SCARICATA, SPIGOLO VIVO

▶ New coating and tool geometry applied resulting outstanding cutting abilities and wear resistance.
 ▶ Excellent for cutting prehardened steels, carbon steels, alloy steels of molds and dies, up to HRC55 and machine parts.
 ▶ Available in several effective lengths of cut and also overall lengths than previous standard products.

▶ Aufgrund einer neuartigen Beschichtung und neuer Werkzeuggeometrien hervorragende Schnittleistung und Verschleißfestigkeit
 ▶ Hervorragende Leistung bei der Zerspaltung von vorvergüteten Stählen bis HRC55, welche im Werkzeug- und Formenbau Verwendung finden.
 ▶ Erhältlich in verschiedenen gesamt Längen und effektiv Längen. Mehr Auswahlmöglichkeiten als bei den bisherigen standard Produkten.

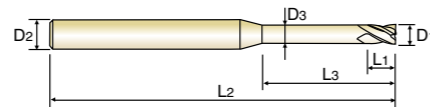

CARBIDE 4 30° PLAIN Coating p.C320-325

Flat Shank	Page	Plain Shank	Page
END MILL HOLDER	D118-137	HYDRAULIC CHUCK SHRINK FIT HOLDER	D15-46 D47-72
-	-	POWER MILLING CHUCK	D161-176
-	-	ER COLLET CHUCK SK SLIM CHUCK	D73-116 D183-201

Unit : mm

EDP No.	Mill Diameter	Shank Diameter	Length of Cut	Length Below Shank	Overall Length	Neck Diameter
	D1	D2	L1	L3	L2	D3
SEME7301002E	1.0	4	1.5	2	50	0.95
SEME7301003E	1.0	4	1.5	3	50	0.95
★ SEME7301004E	1.0	4	1.5	4	50	0.95
★ SEME7301005E	1.0	4	1.5	5	50	0.95
★ SEME7301006E	1.0	4	1.5	6	50	0.95
SEME7301007E	1.0	4	1.5	7	50	0.95
★ SEME7301008E	1.0	4	1.5	8	50	0.95
★ SEME7301010E	1.0	4	1.5	10	50	0.95
★ SEME7301012E	1.0	4	1.5	12	50	0.95
SEME7301014E	1.0	4	1.5	14	50	0.95
SEME7301016E	1.0	4	1.5	16	50	0.95
SEME7301018E	1.0	4	1.5	18	50	0.95
SEME7301020E	1.0	4	1.5	20	50	0.95
SEME7301022E	1.0	4	1.5	22	60	0.95
SEME7301026E	1.0	4	1.5	26	60	0.95
SEME7301030E	1.0	4	1.5	30	70	0.95
SEME7301040E	1.0	4	1.5	40	80	0.95
SEME7301050E	1.0	4	1.5	50	100	0.95
SEME7301204E	1.2	4	1.8	4	50	1.15
SEME7301206E	1.2	4	1.8	6	50	1.15
SEME7301208E	1.2	4	1.8	8	50	1.15
SEME7301210E	1.2	4	1.8	10	50	1.15
SEME7301212E	1.2	4	1.8	12	50	1.15
SEME7301214E	1.2	4	1.8	14	50	1.15

★ : Stock Item ▶ NEXT PAGE

Mill Dia. Tolerance (mm)	Shank Dia. Tolerance
0 ~ -0.03	h5

◎ : Excellent ○ : Good

ISO Material Description	P										M						K																								
	Non-alloy steel					Low alloy steel					High alloyed steel, and tool steel		Stainless steel				Grey cast iron		Nodular cast iron		Malleable cast iron																				
VDI 3323	1	2	3	4	5	6	7	8	9	10	11	12	13	14	15	16	17	18	19	20	21	22	23	24	25	26	27	28	29	30	31	32	33	34	35	36	37	38	39	40	41
HRc	13	25	28	32	30	10	29	32	38	15	35	15	23	10	10	26	3	25	21	21	15	30	25	38	34	200	325	200	240	180	180	260	160	250	130	230					
HB	125	190	250	270	300	180	275	300	350	200	325	200	240	180	180	260	160	250	130	230	125	190	250	270	300	180	275	300	350	200	325	200	240	180	180	260	160	250	130	230	
Recommend	○	○	◎	◎	◎	○	◎	◎	◎	◎	○	○	○	○	○	○	○	○	○	○	○	○	◎	◎	◎	◎	○	◎	◎	◎	○	○	○	○	○	○	○	○	○	○	○

CARBIDE, 4 FLUTE with EXTENDED NECK

- VOLLHARTMETALL, 4 SCHNEIDEN mit ABGESETZTEM SCHAFTTETL
- Fraise carbure, 4 dents, détalonnée
- MD, 4 TAGLIENTI, SCARICATA, SPIGOLO VIVO

▶ New coating and tool geometry applied resulting outstanding cutting abilities and wear resistance.
 ▶ Excellent for cutting prehardened steels, carbon steels, alloy steels of molds and dies, up to HRC55 and machine parts.
 ▶ Available in several effective lengths of cut and also overall lengths than previous standard products.

▶ Aufgrund einer neuartigen Beschichtung und neuer Werkzeuggeometrien hervorragende Schnittleistung und Verschleißfestigkeit
 ▶ Hervorragende Leistung bei der Zerspaltung von vorvergüteten Stählen bis HRC55, welche im Werkzeug- und Formenbau Verwendung finden.
 ▶ Erhältlich in verschiedenen gesamt Längen und effektiv Längen. Mehr Auswahlmöglichkeiten als bei den bisherigen standard Produkten.

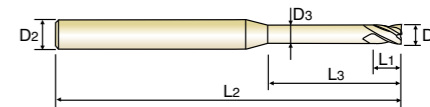

CARBIDE 4 30° PLAIN Coating p.C320-325

Flat Shank	Page	Plain Shank	Page
END MILL HOLDER	D118-137	HYDRAULIC CHUCK SHRINK FIT HOLDER	D15-46 D47-72
-	-	POWER MILLING CHUCK	D161-176
-	-	ER COLLET CHUCK SK SLIM CHUCK	D73-116 D183-201

Unit : mm

EDP No.	Mill Diameter	Shank Diameter	Length of Cut	Length Below Shank	Overall Length	Neck Diameter
	D1	D2	L1	L3	L2	D3
SEME7301216E	1.2	4	1.8	16	50	1.15
SEME7301220E	1.2	4	1.8	20	50	1.15
SEME7301226E	1.2	4	1.8	26	60	1.15
SEME7301230E	1.2	4	1.8	30	70	1.15
SEME7301504E	1.5	4	2.3	4	50	1.45
SEME7301505E	1.5	4	2.3	5	50	1.45
★ SEME7301506E	1.5	4	2.3	6	50	1.45
SEME7301507E	1.5	4	2.3	7	50	1.45
★ SEME7301508E	1.5	4	2.3	8	50	1.45
★ SEME7301510E	1.5	4	2.3	10	50	1.45
★ SEME7301512E	1.5	4	2.3	12	50	1.45
SEME7301514E	1.5	4	2.3	14	50	1.45
★ SEME7301516E	1.5	4	2.3	16	50	1.45
SEME7301518E	1.5	4	2.3	18	50	1.45
SEME7301520E	1.5	4	2.3	20	50	1.45
SEME7301522E	1.5	4	2.3	22	60	1.45
SEME7301526E	1.5	4	2.3	26	60	1.45
SEME7301530E	1.5	4	2.3	30	70	1.45
★ SEME7302006E	2.0	4	3	6	50	1.95
★ SEME7302008E	2.0	4	3	8	50	1.95
★ SEME7302010E	2.0	4	3	10	50	1.95
★ SEME7302012E	2.0	4	3	12	50	1.95
★ SEME7302014E	2.0	4	3	14	50	1.95
★ SEME7302016E	2.0	4	3	16	50	1.95

★ : Stock Item ▶ NEXT PAGE

Mill Dia. Tolerance (mm)	Shank Dia. Tolerance
0 ~ -0.03	h5

◎ : Excellent ○ : Good

ISO Material Description	P										M						K																								
	Non-alloy steel					Low alloy steel					High alloyed steel, and tool steel		Stainless steel				Grey cast iron		Nodular cast iron		Malleable cast iron																				
VDI 3323	1	2	3	4	5	6	7	8	9	10	11	12	13	14	15	16	17	18	19	20	21	22	23	24	25	26	27	28	29	30	31	32	33	34	35	36	37	38	39	40	41
HRc	13	25	28	32	30	10	29	32	38	15	35	15	23	10	10	26	3	25	21	21	15	30	25	38	34	200	325	200	240	180	180	260	160	250	130	230					
HB	125	190	250	270	300	180	275	300	350	200	325	200	240	180	180	260	160	250	130	230	125	190	250	270	300	180	275	300	350	200	325	200	240	180	180	260	160	250	130	230	
Recommend	○	○	◎	◎	◎	○	◎	◎	◎	◎	○	○	○	○	○	○	○	○	○	○	○	○	◎	◎	◎	◎	○	◎	◎	◎	○	○	○	○	○	○	○	○	○	○	○

CARBIDE, 4 FLUTE with EXTENDED NECK

- VOLLHARTMETALL, 4 SCHNEIDEN mit ABGESETZTEM SCHAFTTETL
- (●) Fraise carbure, 4 dents, détalonnée
- (●) MD, 4 TAGLIENTI, SCARICATA, SPIGOLO VIVO

▶ New coating and tool geometry applied resulting outstanding cutting abilities and wear resistance.
 ▶ Excellent for cutting prehardened steels, carbon steels, alloy steels of molds and dies, up to HRC55 and machine parts.
 ▶ Available in several effective lengths of cut and also overall lengths than previous standard products.

▶ Aufgrund einer neuartigen Beschichtung und neuer Werkzeuggeometrien hervorragende Schnittleistung und Verschleißfestigkeit
 ▶ Hervorragende Leistung bei der Zerspaltung von vorvergüteten Stählen bis HRC55, welche im Werkzeug- und Formenbau Verwendung finden.
 ▶ Erhältlich in verschiedenen gesamt Längen und effektiv Längen. Mehr Auswahlmöglichkeiten als bei den bisherigen standard Produkten.

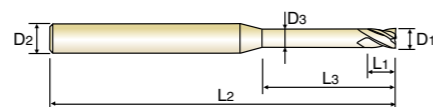

CARBIDE 4 30° PLAIN Coating p.C320-325

Flat Shank	Page	Plain Shank	Page
END MILL HOLDER	D118-137	HYDRAULIC CHUCK SHRINK FIT HOLDER	D15-46 D47-72
-	-	POWER MILLING CHUCK	D161-176
-	-	ER COLLET CHUCK SK SLIM CHUCK	D73-116 D183-201

Unit : mm

EDP No.	Mill Diameter	Shank Diameter	Length of Cut	Length Below Shank	Overall Length	Neck Diameter
	D1	D2	L1	L3	L2	D3
SEME7302018E	2.0	4	3	18	50	1.95
★ SEME7302020E	2.0	4	3	20	50	1.95
SEME7302022E	2.0	4	3	22	60	1.95
★ SEME7302026E	2.0	4	3	26	60	1.95
SEME7302030E	2.0	4	3	30	70	1.95
SEME7302035E	2.0	4	3	35	70	1.95
SEME7302040E	2.0	4	3	40	80	1.95
SEME7302045E	2.0	4	3	45	90	1.95
SEME7302050E	2.0	4	3	50	100	1.95
SEME7302060E	2.0	4	3	60	110	1.95
SEME7302508E	2.5	4	4	8	50	2.40
★ SEME7302510E	2.5	4	4	10	50	2.40
★ SEME7302512E	2.5	4	4	12	50	2.40
SEME7302514E	2.5	4	4	14	50	2.40
SEME7302516E	2.5	4	4	16	50	2.40
SEME7302518E	2.5	4	4	18	50	2.40
SEME7302520E	2.5	4	4	20	50	2.40
SEME7302522E	2.5	4	4	22	60	2.40
SEME7302526E	2.5	4	4	26	60	2.40
SEME7302530E	2.5	4	4	30	70	2.40
SEME7302535E	2.5	4	4	35	70	2.40
SEME7302540E	2.5	4	4	40	80	2.40
SEME7302545E	2.5	4	4	45	90	2.40
SEME7302550E	2.5	4	4	50	100	2.40
SEME7303006E	3.0	6	4.5	6	50	2.85
★ SEME7303008E	3.0	6	4.5	8	50	2.85

★ : Stock Item

▶ NEXT PAGE

Mill Dia. Tolerance (mm)	Shank Dia. Tolerance
0 ~ - 0.03	h5

◎ : Excellent ○ : Good

ISO Material Description	P										M						K					
	Non-alloy steel					Low alloy steel					High alloyed steel, and tool steel		Stainless steel				Grey cast iron		Nodular cast iron		Malleable cast iron	
VDI 3323	1	2	3	4	5	6	7	8	9	10	11	12	13	14	15	16	17	18	19	20		
HRc	13	25	28	32	30	10	29	32	38	15	35	15	23	10	10	26	3	25	21	21		
HB	125	190	250	270	300	180	275	300	350	200	325	200	240	180	180	260	160	250	130	230		
Recommend	○	○	◎	◎	◎	○	◎	◎	◎	◎	◎	○	○	○	○	○	○	○	○	○	○	

ISO Material Description	N										S						H						
	Aluminum-wrought alloy		Aluminum-cast, alloyed			Copper and Copper Alloys (Bronze / Brass)					Non Metallic Materials		Heat Resistant Super Alloys				Titanium Alloys		Hardened steel		Chilled Cast Iron		Hardened Cast Iron
VDI 3323	21	22	23	24	25	26	27	28	29	30	31	32	33	34	35	36	37	38	39	40	41		
HRc	15	30	25	38	34	15	30	25	38	34	15	30	25	38	34	400 Rm	1050 Rm	55	60	42	41		
HB	60	100	75	90	130	110	90	100			200	280	250	350	320	400 Rm	1050 Rm	550	630	400	550		
Recommend											○	○	○	○	○	○	○	○	○	○	○	○	

CARBIDE, 4 FLUTE with EXTENDED NECK

- VOLLHARTMETALL, 4 SCHNEIDEN mit ABGESETZTEM SCHAFTTETL
- (●) Fraise carbure, 4 dents, détalonnée
- (●) MD, 4 TAGLIENTI, SCARICATA, SPIGOLO VIVO

▶ New coating and tool geometry applied resulting outstanding cutting abilities and wear resistance.
 ▶ Excellent for cutting prehardened steels, carbon steels, alloy steels of molds and dies, up to HRC55 and machine parts.
 ▶ Available in several effective lengths of cut and also overall lengths than previous standard products.

▶ Aufgrund einer neuartigen Beschichtung und neuer Werkzeuggeometrien hervorragende Schnittleistung und Verschleißfestigkeit
 ▶ Hervorragende Leistung bei der Zerspaltung von vorvergüteten Stählen bis HRC55, welche im Werkzeug- und Formenbau Verwendung finden.
 ▶ Erhältlich in verschiedenen gesamt Längen und effektiv Längen. Mehr Auswahlmöglichkeiten als bei den bisherigen standard Produkten.

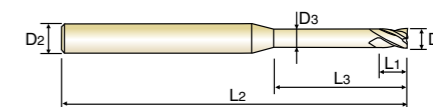

CARBIDE 4 30° PLAIN Coating p.C320-325

Flat Shank	Page	Plain Shank	Page
END MILL HOLDER	D118-137	HYDRAULIC CHUCK SHRINK FIT HOLDER	D15-46 D47-72
-	-	POWER MILLING CHUCK	D161-176
-	-	ER COLLET CHUCK SK SLIM CHUCK	D73-116 D183-201

Unit : mm

EDP No.	Mill Diameter	Shank Diameter	Length of Cut	Length Below Shank	Overall Length	Neck Diameter
	D1	D2	L1	L3	L2	D3
★ SEME7303010E	3.0	6	4.5	10	50	2.85
SEME7303012E	3.0	6	4.5	12	50	2.85
★ SEME7303014E	3.0	6	4.5	14	60	2.85
SEME7303016E	3.0	6	4.5	16	60	2.85
★ SEME7303018E	3.0	6	4.5	18	60	2.85
SEME7303020E	3.0	6	4.5	20	60	2.85
★ SEME7303022E	3.0	6	4.5	22	65	2.85
★ SEME7303026E	3.0	6	4.5	26	65	2.85
SEME7303030E	3.0	6	4.5	30	70	2.85
SEME7303035E	3.0	6	4.5	35	70	2.85
SEME7303040E	3.0	6	4.5	40	80	2.85
SEME7303045E	3.0	6	4.5	45	90	2.85
SEME7303050E	3.0	6	4.5	50	100	2.85
SEME7303060E	3.0	6	4.5	60	100	2.85
SEME7304008E	4.0	6	6	8	50	3.85
★ SEME7304010E	4.0	6	6	10	50	3.85
SEME7304012E	4.0	6	6	12	50	3.85
★ SEME7304014E	4.0	6	6	14	60	3.85
SEME7304016E	4.0	6	6	16	60	3.85
★ SEME7304018E	4.0	6	6	18	60	3.85
SEME7304020E	4.0	6	6	20	60	3.85
★ SEME7304022E	4.0	6	6	22	65	3.85
SEME7304025E	4.0	6	6	25	65	3.85
★ SEME7304026E	4.0	6	6	26	65	3.85
SEME7304030E	4.0	6	6	30	70	3.85
★ SEME7304035E	4.0	6	6	35	70	3.85

★ : Stock Item

▶ NEXT PAGE

Mill Dia. Tolerance (mm)	Shank Dia. Tolerance
0 ~ - 0.03	h5

◎ : Excellent ○ : Good

ISO Material Description	P										M						K					
	Non-alloy steel					Low alloy steel					High alloyed steel, and tool steel		Stainless steel				Grey cast iron		Nodular cast iron		Malleable cast iron	
VDI 3323	1	2	3	4	5	6	7	8	9	10	11	12	13	14	15	16	17	18	19	20		
HRc	13	25	28	32	30	10	29	32	38	15	35	15	23	10	10	26	3	25	21	21		
HB	125	190	250	270	300	180	275	300	350	200	325	200	240	180	180	260	160	250	130	230		
Recommend	○	○	◎	◎	◎	○	◎	◎	◎	◎	◎	○	○	○	○	○	○	○	○	○	○	

ISO Material Description	N										S						H						
	Aluminum-wrought alloy		Aluminum-cast, alloyed			Copper and Copper Alloys (Bronze / Brass)					Non Metallic Materials		Heat Resistant Super Alloys				Titanium Alloys		Hardened steel		Chilled Cast Iron		Hardened Cast Iron
VDI 3323	21	22	23	24	25	26	27	28	29	30	31	32	33	34	35	36	37	38	39	40	41		
HRc	15	30	25	38	34	15	30	25	38	34	15	30	25	38	34	400 Rm	1050 Rm	55	60	42	41		
HB	60	100	75	90	130	110	90	100			200	280	250	350	320	400 Rm	1050 Rm	550	630	400	550		
Recommend											○	○	○	○	○	○	○	○	○	○	○	○	



PLAIN SHANK SEME73 SERIES

CARBIDE, 4 FLUTE with EXTENDED NECK

- VOLLHARTMETALL, 4 SCHNEIDEN mit ABGESETZTEM SCHAFTTETL
- (●) Fraise carbure, 4 dents, détalonnée
- (●) MD, 4 TAGLIENTI, SCARICATA, SPIGOLO VIVO

- ▶ New coating and tool geometry applied resulting outstanding cutting abilities and wear resistance.
- ▶ Excellent for cutting prehardened steels, carbon steels, alloy steels of molds and dies, up to HRC55 and machine parts.
- ▶ Available in several effective lengths of cut and also overall lengths than previous standard products.

- ▶ Aufgrund einer neuartigen Beschichtung und neuer Werkzeuggeometrien hervorragende Schnittleistung und Verschleißfestigkeit
- ▶ Hervorragende Leistung bei der Zerspaltung von vorvergüteten Stählen bis HRC55, welche im Werkzeug- und Formenbau Verwendung finden.
- ▶ Erhältlich in verschiedenen gesamt Längen und effektiv Längen. Mehr Auswahlmöglichkeiten als bei den bisherigen standard Produkten.

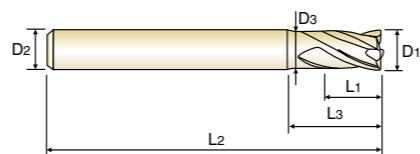

Flat Shank	Page	Plain Shank	Page
END MILL HOLDER	D118-137	HYDRAULIC CHUCK SHRINK FIT HOLDER	D15-46 D47-72
-	-	POWER MILLING CHUCK	D161-176
-	-	ER COLLET CHUCK SK SLIM CHUCK	D73-116 D183-201

EDP No.	Mill Diameter	Shank Diameter	Length of Cut	Length Below Shank	Overall Length	Neck Diameter
	D1	D2	L1	L3	L2	D3
SEME7304040E	4.0	6	6	40	80	3.85
SEME7304045E	4.0	6	6	45	90	3.85
SEME7304050E	4.0	6	6	50	100	3.85
SEME7304060E	4.0	6	6	60	100	3.85
★ SEME7305016E	5.0	6	8	16	60	4.85
SEME7305020E	5.0	6	8	20	60	4.85
SEME7305026E	5.0	6	8	26	65	4.85
SEME7305030E	5.0	6	8	30	70	4.85
★ SEME7305035E	5.0	6	8	35	75	4.85
SEME7305040E	5.0	6	8	40	80	4.85
SEME7305050E	5.0	6	8	50	90	4.85
★ SEME7305060E	5.0	6	8	60	100	4.85
★ SEME7306015E	6.0	6	9	15	60	5.85
★ SEME7306020E	6.0	6	9	20	60	5.85
★ SEME7306030E	6.0	6	9	30	70	5.85
★ SEME7306032E	6.0	6	9	32	90	5.85
SEME7308025E	8.0	8	12	25	70	7.70
★ SEME7308030E	8.0	8	12	30	80	7.70
★ SEME7308042E	8.0	8	12	42	100	7.70
SEME7310030E	10.0	10	15	30	75	9.70
★ SEME7310035E	10.0	10	15	35	80	9.70
★ SEME7310045E	10.0	10	15	45	100	9.70
SEME7312035E	12.0	12	20	35	80	11.70
★ SEME7312040E	12.0	12	20	40	90	11.70
SEME7312050E	12.0	12	20	50	110	11.70

★ : Stock Item

Mill Dia. Tolerance (mm)	Shank Dia. Tolerance
0 ~ -0.03	h5

◎ : Excellent ○ : Good

ISO Material Description	P										M						K					
	Non-alloy steel					Low alloy steel					High alloyed steel, and tool steel		Stainless steel				Grey cast iron		Nodular cast iron		Malleable cast iron	
VDI 3323	1	2	3	4	5	6	7	8	9	10	11	12	13	14	15	16	17	18	19	20		
HRc	13	25	28	32	38	10	29	32	38	15	35	15	23	10	10	26	3	25	21	21		
HB	125	190	250	270	300	180	275	300	350	200	325	200	240	180	180	260	160	250	130	230		
Recommend	○	○	◎	◎	◎	○	◎	◎	◎	◎	○	○	○	○	○	○	○	○	○	○	○	



PLAIN SHANK SEME75 SERIES

CARBIDE, 6 FLUTE 45° HELIX (Regular, Long Shank)

- VOLLHARTMETALL, 6 SCHNEIDEN 45° RECHTSSPIRALE
- (●) Fraise carbure, 6 dents, hélice 45°
- (●) MD, 6 TAGLIENTI, ELICA 45°, SPIGOLO VIVO (Serie media e lunga)

- ▶ New coating and tool geometry applied resulting outstanding cutting abilities and wear resistance.
- ▶ Excellent performance when cutting prehardened steels, up to HRC55 which are used for molds & dies.
- ▶ From the 45 helix angle, better surface roughness can be achieved at side cutting.
- ▶ Available in several effective lengths of cut and also overall lengths

- ▶ Aufgrund einer neuartigen Beschichtung und neuer Werkzeuggeometrien hervorragende Schnittleistung und Verschleißfestigkeit
- ▶ Hervorragende Leistung bei der Zerspaltung von vorvergüteten Stählen bis HRC55, welche im Werkzeug- und Formenbau Verwendung finden.
- ▶ Aufgrund der 45° Spirale werden bessere Oberflächengüten bei der Eckbearbeitung erreicht
- ▶ Erhältlich in verschiedenen gesamt Längen und effektiv Längen.



Flat Shank	Page	Plain Shank	Page
END MILL HOLDER	D118-137	HYDRAULIC CHUCK SHRINK FIT HOLDER	D15-46 D47-72
-	-	POWER MILLING CHUCK	D161-176
-	-	ER COLLET CHUCK SK SLIM CHUCK	D73-116 D183-201

EDP No.	Mill Diameter	Shank Diameter	Length of Cut	Overall Length	Remark
	D1	D2	L1	L2	
★ SEME75060E	6.0	6	15	60	Regular
SEME7506020E	6.0	6	20	70	Long
★ SEME7506030E	6.0	6	30	80	Long
SEME7506030110E	6.0	6	30	110	Long
★ SEME75080E	8.0	8	20	70	Regular
★ SEME7508030E	8.0	8	30	80	Long
SEME7508035E	8.0	8	35	90	Long
★ SEME7508040E	8.0	8	40	90	Long
SEME7508040130E	8.0	8	40	130	Long
★ SEME75100E	10.0	10	25	75	Regular
SEME7510030E	10.0	10	30	80	Long
★ SEME7510040E	10.0	10	40	90	Long
SEME7510050E	10.0	10	50	100	Long
SEME7510050150E	10.0	10	50	150	Long
★ SEME75120E	12.0	12	30	80	Regular
★ SEME7512040E	12.0	12	40	90	Long
★ SEME7512050E	12.0	12	50	100	Long
SEME7512060E	12.0	12	60	110	Long
SEME7512060150E	12.0	12	60	150	Long
★ SEME75160E	16.0	16	40	100	Regular
SEME7516050E	16.0	16	50	110	Long
★ SEME7516060E	16.0	16	60	120	Long
SEME7516090E	16.0	16	90	150	Long
SEME75160110E	16.0	16	110	200	Long

★ : Stock Item

Mill Dia. Tolerance (mm)	Shank Dia. Tolerance
0 ~ -0.03	h5

◎ : Excellent ○ : Good

ISO Material Description	P										M						K					
	Non-alloy steel					Low alloy steel					High alloyed steel, and tool steel		Stainless steel				Grey cast iron		Nodular cast iron		Malleable cast iron	
VDI 3323	1	2	3	4	5	6	7	8	9	10	11	12	13	14	15	16	17	18	19	20		
HRc	13	25	28	32	38	10	29	32	38	15	35	15	23	10	10	26	3	25	21	21		
HB	125	190	250	270	300	180	275	300	350	200	325	200	240	180	180	260	160	250	130	230		
Recommend	○	○	◎	◎	◎	○	◎	◎	◎	◎	○	○	○	○	○	○	○	○	○	○	○	

▶ NEXT PAGE



PLAIN SHANK SEME75 SERIES

CARBIDE, 6 FLUTE 45° HELIX (Regular, Long Shank)

- VOLLHARTMETALL, 6 SCHNEIDEN 45° RECHTSSPIRALE
- Fraise carbure, 6 dents, hélice 45°
- MD, 6 TAGLIENTI, ELICA 45°, SPIGOLO VIVO (Serie media e lunga)

- ▶ New coating and tool geometry applied resulting outstanding cutting abilities and wear resistance.
- ▶ Excellent performance when cutting prehardened steels, up to HRC55 which are used for molds & dies.
- ▶ From the 45 helix angle, better surface roughness can be achieved at side cutting.
- ▶ Available in several effective lengths of cut and also overall lengths

- ▶ Aufgrund einer neuartigen Beschichtung und neuer Werkzeuggeometrien hervorragende Schnittleistung und Verschleißfestigkeit
- ▶ Hervorragende Leistung bei der Zerspaltung von vorvergüteten Stählen bis HRC55, welche im Werkzeug- und Formenbau Verwendung finden.
- ▶ Aufgrund der 45° Spirale werden bessere Oberflächengüten bei der Eckbearbeitung erreicht
- ▶ Erhältlich in verschiedenen gesamt Längen und effektiv Längen.

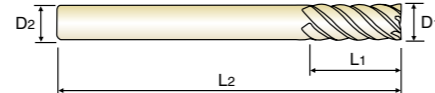

CARBIDE 6 45° PLAIN Coating Y p.C326-327

Flat Shank	Page	Plain Shank	Page
END MILL HOLDER	D118-137	HYDRAULIC CHUCK SHRINK FIT HOLDER	D15-46 D47-72
-	-	POWER MILLING CHUCK	D161-176
-	-	ER COLLET CHUCK SK SLIM CHUCK	D73-116 D183-201

Unit : mm

EDP No.	Mill Diameter	Shank Diameter	Length of Cut	Overall Length	Remark
	D1	D2	L1	L2	
SEME75160110250E	16.0	16	110	250	Long
★ SEME75200E	20.0	20	45	100	Regular
★ SEME7520060E	20.0	20	60	120	Long
SEME7520070E	20.0	20	70	130	Long
SEME75200110E	20.0	20	110	200	Long
SEME75200110250E	20.0	20	110	250	Long
SEME75200110300E	20.0	20	110	300	Long

★ : Stock Item

Mill Dia. Tolerance (mm)	Shank Dia. Tolerance
0 ~ - 0.03	h5

◎ : Excellent ○ : Good

ISO Material Description	P										M				K					
	Non-alloy steel					Low alloy steel					High alloyed steel, and tool steel		Stainless steel		Grey cast iron		Nodular cast iron		Malleable cast iron	
VDI 3323	1	2	3	4	5	6	7	8	9	10	11	12	13	14	15	16	17	18	19	20
HRc	13	25	28	32	35	38	40	42	45	48	50	52	54	56	58	60	62	64	66	68
HB	125	190	250	270	300	180	275	300	350	200	325	200	240	180	180	260	160	250	130	230
Recommend	○	○	◎	◎	◎	◎	◎	◎	◎	◎	◎	◎	◎	◎	○	○	○	○	○	○

ISO Material Description	N					S					H											
	Aluminum-wrought alloy		Aluminum-cast, alloyed			Copper and Copper Alloys (Bronze / Brass)			Non Metallic Materials		Heat Resistant Super Alloys					Titanium Alloys		Hardened steel		Chilled Cast Iron		Hardened Cast Iron
VDI 3323	21	22	23	24	25	26	27	28	29	30	31	32	33	34	35	36	37	38	39	40	41	
HRc	21	22	23	24	25	26	27	28	29	30	31	32	33	34	35	36	37	38	39	40	41	
HB	60	100	75	90	130	110	90	100			200	280	250	350	320	400 Rm	1050 Rm	550	630	400	550	
Recommend	○	○	○	○	○	○	○	○	○	○	○	○	○	○	○	○	○	○	○	○	○	



PLAIN SHANK G9D75 SERIES
FLAT SHANK G9D67 SERIES

CARBIDE, 4&5 FLUTE MULTIPLE HELIX CORNER RADIUS - SHORT LENGTH

- VOLLHARTMETALL, 4&5 SCHNEIDEN MEHRSPIRAL Fräser KURZ ECKENRADIUS
- Fraise carbure, 4&5 dents, torique, hélice multiple, courte
- MD, 4 & 5 TAGLIENTI, TORICA, SERIE CORTA

- ▶ Unique flute design for excellent chip evacuation and vibration reduction.
- ▶ Optimal roughing tooth profile to reduce cutting forces.
- ▶ Special tool geometry for high feed rate and heavy cutting.
- ▶ Strong end tooth design for plunge and pocket milling.
- ▶ Custom engineered coating to allow long tool life and excellent chip evacuation.

- ▶ einzigartige Nutengeometrie für hervorragenden Spänentransport und Vibrationsreduzierung
- ▶ neuartiges Schruppprofil zur Reduzierung der Schnittkräfte
- ▶ Spezielle Werkzeuggeometrie für Hochvorschub- und Schwerzerspannung geeignet
- ▶ speziell entwickelte Schneidengeometrie für Tauch- und Taschenfräsen
- ▶ YG-1 eigene Beschichtung um lange Lebensdauer und sehr guten Spänentransport zu gewährleisten

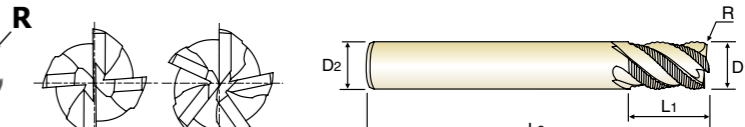

CARBIDE 4&5 44°~45° PLAIN FLAT Coating Y p.C328

Flat Shank	Page	Plain Shank	Page
END MILL HOLDER	D118-137	HYDRAULIC CHUCK SHRINK FIT HOLDER	D15-46 D47-72
-	-	POWER MILLING CHUCK	D161-176
-	-	ER COLLET CHUCK SK SLIM CHUCK	D73-116 D183-201

Unit : mm

EDP No.	Corner Radius	Mill Diameter	Shank Diameter	Length of Cut	Overall Length	No. of Flute	
	R	D1	D2	L1	L2		
G9D75060	G9D67060	R0.5	6.0	6	9	57	4
G9D75080	G9D67080	R0.5	8.0	8	12	63	4
G9D75100	G9D67100	R0.5	10.0	10	15	72	4
G9D75120	G9D67120	R0.5	12.0	12	18	83	4
G9D75160	G9D67160	R1.0	16.0	16	24	92	5
G9D75200	G9D67200	R1.0	20.0	20	30	104	5

Mill Dia. Tolerance (mm)	Shank Dia. Tolerance
0 ~ - 0.05	h5

◎ : Excellent ○ : Good

ISO Material Description	P										M				K					
	Non-alloy steel					Low alloy steel					High alloyed steel, and tool steel		Stainless steel		Grey cast iron		Nodular cast iron		Malleable cast iron	
VDI 3323	1	2	3	4	5	6	7	8	9	10	11	12	13	14	15	16	17	18	19	20
HRc	13	25	28	32	35	38	40	42	45	48	50	52	54	56	58	60	62	64	66	68
HB	125	190	250	270	300	180	275	300	350	200	325	200	240	180	180	260	160	250	130	230
Recommend	○	○	◎	◎	◎	◎	◎	◎	◎	◎	◎	◎	◎	◎	○	○	○	○	○	○

ISO Material Description	N					S					H											
	Aluminum-wrought alloy		Aluminum-cast, alloyed			Copper and Copper Alloys (Bronze / Brass)			Non Metallic Materials		Heat Resistant Super Alloys					Titanium Alloys		Hardened steel		Chilled Cast Iron		Hardened Cast Iron
VDI 3323	21	22	23	24	25	26	27	28	29	30	31	32	33	34	35	36	37	38	39	40	41	
HRc	21	22	23	24	25	26	27	28	29	30	31	32	33	34	35	36	37	38	39	40	41	
HB	60	100	75	90	130	110	90	100			200	280	250	350	320	400 Rm	1050 Rm	550	630	400	550	
Recommend	○	○	○	○	○	○	○	○	○	○	○	○	○	○	○	○	○	○	○	○	○	

CARBIDE, 4&5 FLUTE MULTIPLE HELIX CORNER RADIUS - LONG LENGTH

VOLLHARTMETALL, 4&5 SCHNEIDEN MEHRSPIRAL Fräser KURZ ECKENRADIUS
 () Fraise carbure, 4&5 dents, torique, hélice multiple, courte
 () MD, 4 & 5 TAGLIANTI, TORICA, SERIE CORTA

- ▶ Unique flute design for excellent chip evacuation and vibration reduction.
- ▶ Optimal roughing tooth profile to reduce cutting forces.
- ▶ Special tool geometry for high feed rate and heavy cutting.
- ▶ Strong end tooth design for plunge and pocket milling.
- ▶ Custom engineered coating to allow long tool life and excellent chip evacuation.

- ▶ einzigartige Nutengeometrie für hervorragenden Späntransport und Vibrationsreduzierung
- ▶ neuartiges Schruppprofil zur Reduzierung der Schnittkräfte
- ▶ Spezielle Werkzeuggeometrie für Hochvorschub- und Schwerzerspannung geeignet
- ▶ speziell entwickelte Schneidengeometrie für Tauch- und Taschenfräsen
- ▶ YG-1 eigene Beschichtung um lange Lebensdauer und sehr guten Späntransport zu gewährleisten

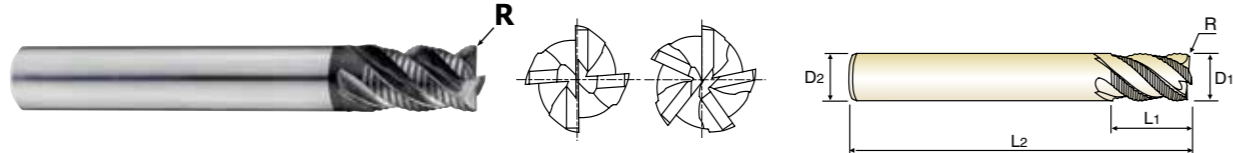

CARBIDE 4&5 44°~45° PLAIN FLAT Coating Y p.C328

Flat Shank	Page	Plain Shank	Page
END MILL HOLDER	D118-137	HYDRAULIC CHUCK SHRINK FIT HOLDER	D15-46 D47-72
-	-	POWER MILLING CHUCK	D161-176
-	-	ER COLLET CHUCK SK SLIM CHUCK	D73-116 D183-201

Unit : mm

EDP No.	Corner Radius	Mill Diameter	Shank Diameter	Length of Cut	Overall Length	No. of Flute	
							PLAIN
G9D76060	G9D68060	R0.5	6.0	6	12	57	4
G9D76080	G9D68080	R0.5	8.0	8	16	63	4
G9D76100	G9D68100	R0.5	10.0	10	20	72	4
G9D76120	G9D68120	R0.5	12.0	12	24	83	4
G9D76160	G9D68160	R1.0	16.0	16	32	92	5
G9D76200	G9D68200	R1.0	20.0	20	40	104	5

Mill Dia. Tolerance (mm)	Shank Dia. Tolerance
0 ~ - 0.05	h5

◎ : Excellent ○ : Good

ISO Material Description	P										M				K						
	Non-alloy steel					Low alloy steel					High alloyed steel, and tool steel				Stainless steel		Grey cast iron		Nodular cast iron		Malleable cast iron
VDI 3323	1	2	3	4	5	6	7	8	9	10	11	12	13	14	15	16	17	18	19	20	
HRc	13	25	28	32	38	10	29	32	38	15	35	15	23	10	10	26	3	25	21	21	
HB	125	190	250	270	300	180	275	300	350	200	325	200	240	180	180	260	160	250	130	230	
Recommend	○	○	◎	◎	◎	○	◎	◎	◎	◎	◎	○	○	◎	◎	◎	◎	◎	◎	◎	◎

ISO Material Description	N					S					H											
	Aluminum-wrought alloy		Aluminum-cast, alloyed			Copper and Copper Alloys (Bronze / Brass)			Non Metallic Materials		Heat Resistant Super Alloys					Titanium Alloys		Hardened steel		Chilled Cast Iron		Hardened Cast Iron
VDI 3323	21	22	23	24	25	26	27	28	29	30	31	32	33	34	35	36	37	38	39	40	41	
HRc	21	22	23	24	25	26	27	28	29	30	31	32	33	34	35	36	37	38	39	40	41	
HB	60	100	75	90	130	110	90	100			200	280	250	350	320	400 Rm	1050 Rm	550	630	400	550	
Recommend						○	○	○														

CARBIDE, 4&5 FLUTE MULTIPLE HELIX LONG REACH CORNER RADIUS

VOLLHARTMETALL, 4&5 SCHNEIDEN MEHRSPIRAL Fräser GROÙE REICHWEITE ECKENRADIUS
 () Fraise carbure, 4&5 dents, torique longue portée, hélice multiple
 () MD, 4 & 5 TAGLIANTI, TORICA, SCARICATA, SERIE LUNGS

- ▶ Unique flute design for excellent chip evacuation and vibration reduction.
- ▶ Optimal roughing tooth profile to reduce cutting forces.
- ▶ Special tool geometry for high feed rate and heavy cutting.
- ▶ Strong end tooth design for plunge and pocket milling.
- ▶ Custom engineered coating to allow long tool life and excellent chip evacuation.

- ▶ einzigartige Nutengeometrie für hervorragenden Späntransport und Vibrationsreduzierung
- ▶ neuartiges Schruppprofil zur Reduzierung der Schnittkräfte
- ▶ Spezielle Werkzeuggeometrie für Hochvorschub- und Schwerzerspannung geeignet
- ▶ speziell entwickelte Schneidengeometrie für Tauch- und Taschenfräsen
- ▶ YG-1 eigene Beschichtung um lange Lebensdauer und sehr guten Späntransport zu gewährleisten

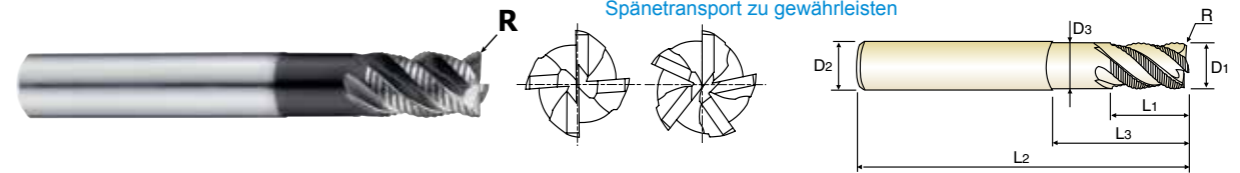

CARBIDE 4&5 44°~45° PLAIN FLAT Coating Y p.C328

Flat Shank	Page	Plain Shank	Page
END MILL HOLDER	D118-137	HYDRAULIC CHUCK SHRINK FIT HOLDER	D15-46 D47-72
-	-	POWER MILLING CHUCK	D161-176
-	-	ER COLLET CHUCK SK SLIM CHUCK	D73-116 D183-201

Unit : mm

EDP No.	Corner Radius	Mill Diameter	Shank Diameter	Length of Cut	Length Below Shank	Overall Length	Neck Diameter	No. of Flute
G9D77060	G9D69060	R0.5	6.0	6	9	18	5.50	4
G9D77080	G9D69080	R0.5	8.0	8	12	24	7.50	4
G9D77100	G9D69100	R0.5	10.0	10	15	30	9.50	4
G9D77120	G9D69120	R0.5	12.0	12	18	36	11.50	4
G9D77160	G9D69160	R1.0	16.0	16	24	48	15.50	5
G9D77200	G9D69200	R1.0	20.0	20	30	60	19.20	5

Mill Dia. Tolerance (mm)	Shank Dia. Tolerance
0 ~ - 0.05	h5

◎ : Excellent ○ : Good

ISO Material Description	P										M				K						
	Non-alloy steel					Low alloy steel					High alloyed steel, and tool steel				Stainless steel		Grey cast iron		Nodular cast iron		Malleable cast iron
VDI 3323	1	2	3	4	5	6	7	8	9	10	11	12	13	14	15	16	17	18	19	20	
HRc	13	25	28	32	38	10	29	32	38	15	35	15	23	10	10	26	3	25	21	21	
HB	125	190	250	270	300	180	275	300	350	200	325	200	240	180	180	260	160	250	130	230	
Recommend	○	○	◎	◎	◎	○	◎	◎	◎	◎	◎	○	○	◎	◎	◎	◎	◎	◎	◎	◎

ISO Material Description	N					S					H											
	Aluminum-wrought alloy		Aluminum-cast, alloyed			Copper and Copper Alloys (Bronze / Brass)			Non Metallic Materials		Heat Resistant Super Alloys					Titanium Alloys		Hardened steel		Chilled Cast Iron		Hardened Cast Iron
VDI 3323	21	22	23	24	25	26	27	28	29	30	31	32	33	34	35	36	37	38	39	40	41	
HRc	21	22	23	24	25	26	27	28	29	30	31	32	33	34	35	36	37	38	39	40	41	
HB	60	100	75	90	130	110	90	100			200	280	250	350	320	400 Rm	1050 Rm	550	630	400	550	
Recommend						○	○	○														



RECOMMENDED CUTTING CONDITIONS
EMPFOHLENE SCHNEIDPARAMETER

SEMD98 SERIES 2 FLUTE BALL NOSE

Vc = m/min.
fz = mm/tooth
RPM = rev./min.
FEED = mm/min.

Table with columns for ISO, VDI 3323, Material Description, Ae, Ap, Parameter, and Diameter (Ø) from 0.1 to 2.5. Rows include P (1-5, 6-8, 9, 10-11.1, 11.2) and K (15-20) series.

▶ NEXT PAGE

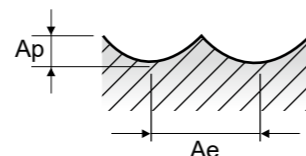

RECOMMENDED CUTTING CONDITIONS
EMPFOHLENE SCHNEIDPARAMETER

SEMD98 SERIES 2 FLUTE BALL NOSE

Vc = m/min.
fz = mm/tooth
RPM = rev./min.
FEED = mm/min.

Table with columns for VDI 3323, Parameter, and Diameter (Ø) from 3.0 to 25.0. Rows include 1-5, 6-8, 9, 10-11.1, 11.2, 15-20, 38.1-38.2, 40, and 41 series.

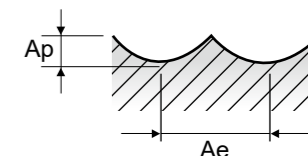



RECOMMENDED CUTTING CONDITIONS
EMPFOHLENE SCHNEIDPARAMETER



RECOMMENDED CUTTING CONDITIONS
EMPFOHLENE SCHNEIDPARAMETER

SEM846 SERIES 2 FLUTE BALL NOSE - SLOTTING

SEM846 SERIES 2 FLUTE BALL NOSE - SLOTTING

Vc = m/min. fz = mm/tooth
RPM = rev./min. FEED = mm/min.
Ap = mm LBS = Length Below Shank

Vc = m/min. fz = mm/tooth
RPM = rev./min. FEED = mm/min.
Ap = mm LBS = Length Below Shank

Table with columns: ISO, VDI 3323, Material Description, Parameter (LBS), Diameter (Ø) ranges (0.1-0.3, 0.3-0.3, 0.3-0.3), and cutting conditions (Vc, fz, RPM, FEED, Ap).

Table with columns: VDI 3323, Parameter (LBS), Diameter (Ø) ranges (0.3-0.4, 0.4-0.4, 0.4-0.4, 0.4-0.4, 0.4-0.5, 0.5-0.5, 0.5-0.5, 0.5-0.5, 0.5-0.5, 0.5-0.5), and cutting conditions (Vc, fz, RPM, FEED, Ap).

▶ NEXT PAGE

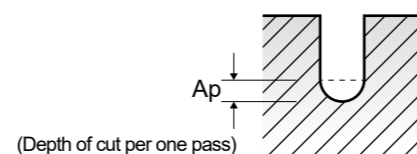

▶ NEXT PAGE

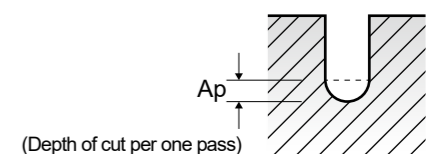



RECOMMENDED CUTTING CONDITIONS
EMPFOHLENE SCHNEIDPARAMETER

SEM846 SERIES 2 FLUTE BALL NOSE - SLOTTING

Vc = m/min. fz = mm/tooth
RPM = rev./min. FEED = mm/min.
Ap = mm LBS = Length Below Shank

Table with columns for ISO, VDI 3323, Parameter, Diameter (Ø), and various cutting parameters (Vc, fz, RPM, FEED, Ap) for different materials and diameters.

▶ NEXT PAGE

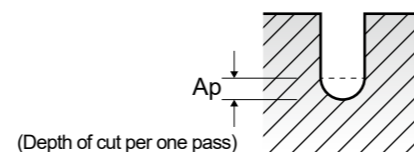

RECOMMENDED CUTTING CONDITIONS
EMPFOHLENE SCHNEIDPARAMETER

SEM846 SERIES 2 FLUTE BALL NOSE - SLOTTING

Vc = m/min. fz = mm/tooth
RPM = rev./min. FEED = mm/min.
Ap = mm LBS = Length Below Shank

Table with columns for VDI 3323, Parameter, Diameter (Ø), and various cutting parameters (Vc, fz, RPM, FEED, Ap) for different materials and diameters.

▶ NEXT PAGE

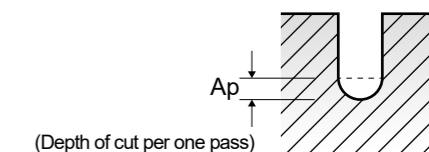

YG 4G MILL END MILLS

RECOMMENDED CUTTING CONDITIONS EMPFOHLENE SCHNEIDPARAMETER

SEM846 SERIES 2 FLUTE BALL NOSE - SLOTTING

Vc = m/min. fz = mm/tooth
RPM = rev./min. FEED = mm/min.
Ap = mm LBS = Length Below Shank

Table with columns for ISO, VDI 3323, Parameter (LBS), Diameter (Ø) from 1.0 to 50, and rows for Vc, fz, RPM, FEED, Ap. Includes material groups P, K, and H.

▶ NEXT PAGE

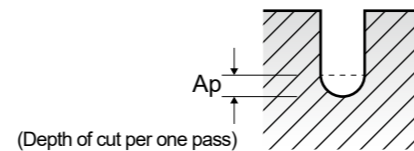

YG 4G MILL END MILLS

RECOMMENDED CUTTING CONDITIONS EMPFOHLENE SCHNEIDPARAMETER

SEM846 SERIES 2 FLUTE BALL NOSE - SLOTTING

Vc = m/min. fz = mm/tooth
RPM = rev./min. FEED = mm/min.
Ap = mm LBS = Length Below Shank

Table with columns for VDI 3323, Parameter (LBS), Diameter (Ø) from 1.2 to 15, and rows for Vc, fz, RPM, FEED, Ap. Includes material groups P, K, and H.

▶ NEXT PAGE

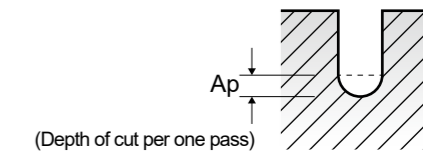

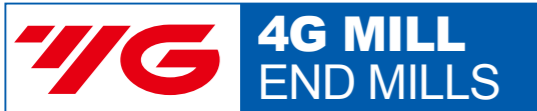

RECOMMENDED CUTTING CONDITIONS EMPFOHLENE SCHNEIDPARAMETER

SEM846 SERIES 2 FLUTE BALL NOSE - SLOTTING

Vc = m/min. fz = mm/tooth
RPM = rev./min. FEED = mm/min.
Ap = mm LBS = Length Below Shank

Table with columns for ISO, VDI 3323, Parameter, Diameter (Ø), and various cutting parameters (Vc, fz, RPM, FEED, Ap) for different materials and diameters.

▶ NEXT PAGE

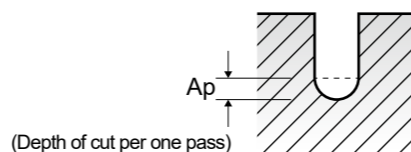

RECOMMENDED CUTTING CONDITIONS EMPFOHLENE SCHNEIDPARAMETER

SEM846 SERIES 2 FLUTE BALL NOSE - SLOTTING

Vc = m/min. fz = mm/tooth
RPM = rev./min. FEED = mm/min.
Ap = mm LBS = Length Below Shank

Table with columns for VDI 3323, Parameter, Diameter (Ø), and various cutting parameters (Vc, fz, RPM, FEED, Ap) for different materials and diameters.

▶ NEXT PAGE

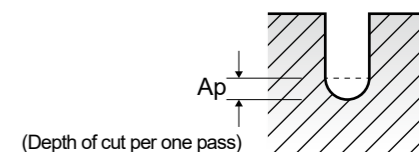



RECOMMENDED CUTTING CONDITIONS
EMPFOHLENE SCHNEIDPARAMETER

SEM846 SERIES 2 FLUTE BALL NOSE - SLOTTING

Vc = m/min. fz = mm/tooth
RPM = rev./min. FEED = mm/min.
Ap = mm LBS = Length Below Shank

Table with columns for ISO, VDI 3323, Parameter, LBS, and Diameter (Ø) ranging from 2.0 to 3.0 mm. Rows include ISO P (1-5, 6-8, 9, 10-11.1, 11.2) and ISO K (15-20) materials.

▶ NEXT PAGE

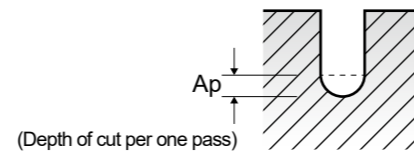

RECOMMENDED CUTTING CONDITIONS
EMPFOHLENE SCHNEIDPARAMETER

SEM846 SERIES 2 FLUTE BALL NOSE - SLOTTING

Vc = m/min. fz = mm/tooth
RPM = rev./min. FEED = mm/min.
Ap = mm LBS = Length Below Shank

Table with columns for VDI 3323, Parameter, LBS, and Diameter (Ø) ranging from 3.0 to 4.0 mm. Rows include ISO P (1-5, 6-8, 9, 10-11.1, 11.2) and ISO K (15-20) materials.

▶ NEXT PAGE

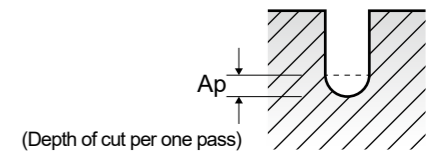

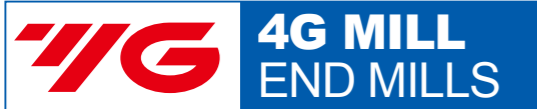

RECOMMENDED CUTTING CONDITIONS
EMPFOHLENE SCHNEIDPARAMETER

SEMD99 SERIES 2 FLUTE CORNER RADIUS - SLOTTING

Vc = m/min.
fz = mm/tooth
RPM = rev./min.
FEED = mm/min.

ISO	VDI 3323	Material Description	Ae	Ap	Parameter	Diameter (Ø)										
						0.2	0.3	0.4	0.5	0.6	0.7	0.8	0.9	1.0	1.2	1.5
P	1-5	Non-alloy steel	1.0D	0.2D	Vc	28	39	52	57	57	66	75	85	87	93	104
					fz	0.002	0.002	0.002	0.003	0.004	0.004	0.004	0.004	0.004	0.005	0.006
					RPM	44563	41380	41380	36287	30239	30012	29842	30063	27693	24669	22069
	6-8	Low alloy steel	1.0D	0.2D	Vc	28	39	52	57	57	66	75	85	87	93	104
					fz	0.002	0.002	0.002	0.003	0.004	0.004	0.004	0.004	0.004	0.005	0.006
					RPM	44563	41380	41380	36287	30239	30012	29842	30063	27693	24669	22069
	9	High alloyed steel, and tool steel	1.0D	0.2D	Vc	18	25	34	37	37	44	50	53	59	64	
					fz	0.001	0.001	0.001	0.002	0.002	0.002	0.002	0.003	0.003	0.004	
					RPM	28648	26526	27056	23555	19629	20008	19894	18745	18144	15650	13581
	10-11.1	High alloyed steel, and tool steel	1.0D	0.2D	Vc	28	39	52	57	57	66	75	85	87	93	104
					fz	0.002	0.002	0.002	0.003	0.004	0.004	0.004	0.004	0.004	0.005	0.006
					RPM	44563	41380	41380	36287	30239	30012	29842	30063	27693	24669	22069
11.2	High alloyed steel, and tool steel	1.0D	0.2D	Vc	18	25	34	37	37	44	50	53	59	64		
				fz	0.001	0.001	0.001	0.002	0.002	0.002	0.002	0.003	0.003	0.004		
				RPM	28648	26526	27056	23555	19629	20008	19894	18745	18144	15650	13581	
K	15-20	Grey cast iron Nodular cast iron Malleable cast iron	1.0D	0.2D	Vc	28	39	52	57	57	66	75	85	87	93	104
					fz	0.002	0.002	0.002	0.003	0.004	0.004	0.004	0.004	0.005	0.006	
					RPM	44563	41380	41380	36287	30239	30012	29842	30063	27693	24669	22069
H	38.1 - 38.2	Hardened steel	1.0D	0.2D	Vc	11	16	21	22	23	27	30	33	35	37	40
					fz	0.001	0.001	0.001	0.002	0.002	0.002	0.002	0.002	0.003	0.003	0.004
					RPM	17507	16977	16711	14006	12202	12278	11937	11671	11141	9815	8488
	40	Chilled Cast Iron	1.0D	0.2D	Vc	18	25	34	37	37	44	50	53	59	64	
					fz	0.001	0.001	0.001	0.002	0.002	0.002	0.002	0.002	0.003	0.003	0.004
					RPM	28648	26526	27056	23555	19629	20008	19894	18745	18144	15650	13581
	41	Hardened Cast Iron	1.0D	0.2D	Vc	11	16	21	22	23	27	30	33	35	37	40
					fz	0.001	0.001	0.001	0.002	0.002	0.002	0.002	0.002	0.003	0.003	0.004
					RPM	17507	16977	16711	14006	12202	12278	11937	11671	11141	9815	8488

▶ NEXT PAGE

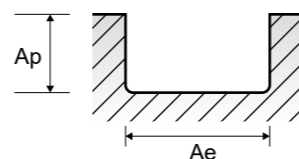

RECOMMENDED CUTTING CONDITIONS
EMPFOHLENE SCHNEIDPARAMETER

SEMD99 SERIES 2 FLUTE CORNER RADIUS - SLOTTING

Vc = m/min.
fz = mm/tooth
RPM = rev./min.
FEED = mm/min.

VDI 3323	Parameter	Diameter (Ø)																
		2.0	2.5	3.0	3.5	4.0	4.5	5.0	5.5	6.0	7.0	8.0	10.0	11.0	12.0	14.0	16.0	20.0
1-5	Vc	113	118	125	132	135	141	144	147	149	153	151	158	158	155	159	156	158
	fz	0.007	0.009	0.011	0.013	0.016	0.019	0.023	0.027	0.032	0.037	0.045	0.054	0.052	0.051	0.054	0.058	0.056
	RPM	17985	15024	13263	12005	10743	9974	9167	8508	7905	6957	6008	5029	4572	4112	3615	3104	2515
6-8	Vc	113	118	125	132	135	141	144	147	149	153	151	158	158	155	159	156	158
	fz	0.007	0.009	0.011	0.013	0.016	0.019	0.023	0.027	0.032	0.037	0.045	0.054	0.052	0.051	0.054	0.058	0.056
	RPM	17985	15024	13263	12005	10743	9974	9167	8508	7905	6957	6008	5029	4572	4112	3615	3104	2515
9	Vc	73	75	81	85	86	89	91	94	95	97	96	103	105	105	107	106	103
	fz	0.005	0.007	0.008	0.01	0.012	0.015	0.017	0.021	0.025	0.028	0.033	0.038	0.04	0.041	0.041	0.04	0.037
	RPM	11618	9549	8594	7730	6844	6295	5793	5440	5040	4411	3820	3279	3038	2785	2433	2109	1639
10 - 11.1	Vc	113	118	125	132	135	141	144	147	149	153	151	158	158	155	159	156	158
	fz	0.007	0.009	0.011	0.013	0.016	0.019	0.023	0.027	0.032	0.037	0.045	0.054	0.052	0.051	0.054	0.058	0.056
	RPM	17985	15024	13263	12005	10743	9974	9167	8508	7905	6957	6008	5029	4572	4112	3615	3104	2515
11.2	Vc	73	75	81	85	86	89	91	94	95	97	96	103	105	105	107	106	103
	fz	0.005	0.007	0.008	0.01	0.012	0.015	0.017	0.021	0.025	0.028	0.033	0.038	0.04	0.041	0.041	0.04	0.037
	RPM	11618	9549	8594	7730	6844	6295	5793	5440	5040	4411	3820	3279	3038	2785	2433	2109	1639
15 - 20	Vc	113	118	125	132	135	141	144	147	149	153	151	158	158	155	159	156	158
	fz	0.007	0.009	0.011	0.013	0.016	0.019	0.023	0.027	0.032	0.037	0.045	0.054	0.052	0.051	0.054	0.058	0.056
	RPM	17985	15024	13263	12005	10743	9974	9167	8508	7905	6957	6008	5029	4572	4112	3615	3104	2515
38.1 - 38.2	Vc	45	48	50	53	54	61	60	61	62	64	63	64	63	64	63	65	64
	fz	0.005	0.006	0.007	0.008	0.009	0.01	0.013	0.016	0.018	0.021	0.024	0.03	0.03	0.03	0.03	0.031	0.03
	RPM	7162	6112	5305	4820	4297	4315	3820	3530	3289	2910	2507	2005	1852	1671	1478	1273	1003
40	Vc	73	75	81	85	86	89	91	94	95	97	96	103	105	105	107	106	103
	fz	0.005	0.007	0.008	0.01	0.012	0.015	0.017	0.021	0.025	0.028	0.033	0.038	0.04	0.041	0.041	0.04	0.037
	RPM	11618	9549	8594	7730	6844	6295	5793	5440	5040	4411	3820	3279	3038	2785	2433	2109	1639
41	Vc	45	48	50	53	54	61	60	61	62	64	63	64	63	64	63	65	64
	fz	0.005	0.006	0.007	0.008	0.009	0.01	0.013	0.016	0.018	0.021	0.024	0.03	0.03	0.03	0.03	0.031	0.03
	RPM	7162	6112	5305	4820	4297	4315	3820	3530	3289	2910	2507	2005	1852	1671	1478	1273	1003

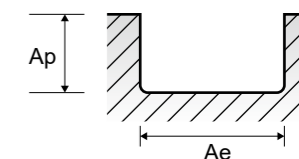



RECOMMENDED CUTTING CONDITIONS
EMPFOHLENE SCHNEIDPARAMETER

SEME61 SERIES 2 FLUTE CORNER RADIUS - SLOTTING

Vc = m/min. fz = mm/tooth
RPM = rev./min. FEED = mm/min.
Ap = mm LBS = Length Below Shank

Table with columns for ISO, VDI 3323, Material Description, Parameter (Vc, fz, RPM, FEED, Ap), and Diameter (Ø) ranges (0.2-0.4 mm).

▶ NEXT PAGE

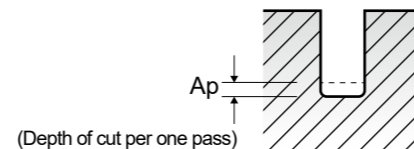

RECOMMENDED CUTTING CONDITIONS
EMPFOHLENE SCHNEIDPARAMETER

SEME61 SERIES 2 FLUTE CORNER RADIUS - SLOTTING

Vc = m/min. fz = mm/tooth
RPM = rev./min. FEED = mm/min.
Ap = mm LBS = Length Below Shank

Table with columns for VDI 3323, Parameter (Vc, fz, RPM, FEED, Ap), and Diameter (Ø) ranges (0.4-0.7 mm).

▶ NEXT PAGE

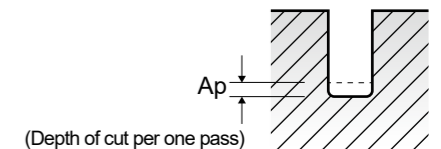

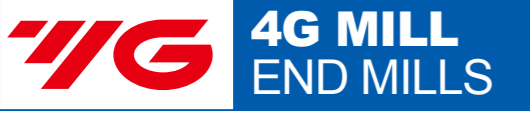

RECOMMENDED CUTTING CONDITIONS
EMPFOHLENE SCHNEIDPARAMETER



RECOMMENDED CUTTING CONDITIONS
EMPFOHLENE SCHNEIDPARAMETER

SEME61 SERIES 2 FLUTE CORNER RADIUS - SLOTTING

SEME61 SERIES 2 FLUTE CORNER RADIUS - SLOTTING

Vc = m/min. fz = mm/tooth
RPM = rev./min. FEED = mm/min.
Ap = mm LBS = Length Below Shank

Vc = m/min. fz = mm/tooth
RPM = rev./min. FEED = mm/min.
Ap = mm LBS = Length Below Shank

Table with columns for ISO, VDI 3323, Parameter, Diameter (D), and cutting parameters (Vc, fz, RPM, FEED, Ap) for various materials (P, K, H) and sizes (1-5, 6-8, 9, 10-11.1, 11.2, 15-20, 38.1-38.2, 40, 41).

Table with columns for VDI 3323, Parameter, Diameter (D), and cutting parameters (Vc, fz, RPM, FEED, Ap) for various materials (P, K, H) and sizes (1-5, 6-8, 9, 10-11.1, 11.2, 15-20, 38.1-38.2, 40, 41).

▶ NEXT PAGE

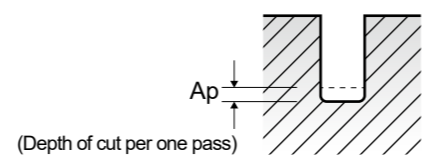

▶ NEXT PAGE

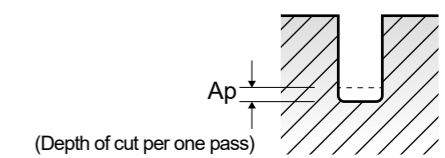

HSS

HSS



RECOMMENDED CUTTING CONDITIONS
EMPFOHLENE SCHNEIDPARAMETER



RECOMMENDED CUTTING CONDITIONS
EMPFOHLENE SCHNEIDPARAMETER

SEME61 SERIES 2 FLUTE CORNER RADIUS - SLOTTING

SEME61 SERIES 2 FLUTE CORNER RADIUS - SLOTTING

Vc = m/min. fz = mm/tooth
RPM = rev./min. FEED = mm/min.
Ap = mm LBS = Length Below Shank

Vc = m/min. fz = mm/tooth
RPM = rev./min. FEED = mm/min.
Ap = mm LBS = Length Below Shank

Table with columns for ISO, VDI 3323, Parameter, Diameter (Ø) from 3.0 to 4.0, and rows for ISO P (1-5, 6-8, 9, 10-11.1, 11.2) and ISO K (15-20) and ISO H (38.1-38.2, 40, 41) with parameters Vc, fz, RPM, FEED, Ap.

Table with columns for VDI 3323, Parameter, Diameter (Ø) from 4.0 to 20.0, and rows for ISO P (1-5, 6-8, 9, 10-11.1, 11.2) and ISO K (15-20) and ISO H (38.1-38.2, 40, 41) with parameters Vc, fz, RPM, FEED, Ap.

▶ NEXT PAGE

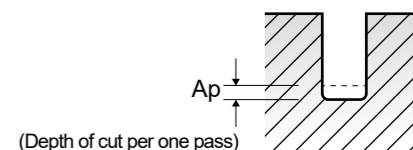
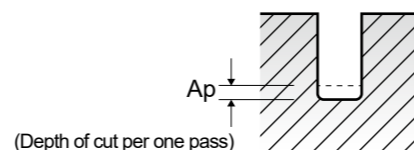

SEME01 SERIES 4 FLUTE CORNER RADIUS - SIDE CUTTING

Vc = m/min.
fz = mm/tooth
RPM = rev./min.
FEED = mm/min.

ISO	VDI 3323	Material Description	Ae	Ap	Parameter	Diameter (Ø)							
						1.0	1.2	1.5	2.0	2.5	3.0	3.5	4.0
P	1-5	Non-alloy steel	0.05D	2D	Vc	87	93	104	113	118	125	132	135
					fz	0.003	0.003	0.004	0.004	0.006	0.006	0.008	0.01
					RPM	27693	24669	22069	17985	15024	13263	12005	10743
	6-8	Low alloy steel	0.05D	2D	Vc	87	93	104	113	118	125	132	135
					fz	0.003	0.003	0.004	0.004	0.006	0.006	0.008	0.01
					RPM	27693	24669	22069	17985	15024	13263	12005	10743
	9	High alloyed steel, and tool steel	0.05D	2D	Vc	57	59	64	73	75	81	85	86
					fz	0.003	0.004	0.004	0.005	0.007	0.008	0.009	0.011
					RPM	18144	15650	13581	11618	9549	8594	7730	6844
	10-11.1	High alloyed steel, and tool steel	0.05D	2D	Vc	87	93	104	113	118	125	132	135
					fz	0.003	0.003	0.004	0.004	0.006	0.006	0.008	0.01
					RPM	27693	24669	22069	17985	15024	13263	12005	10743
11.2	High alloyed steel, and tool steel	0.05D	2D	Vc	57	59	64	73	75	81	85	86	
				fz	0.003	0.004	0.004	0.005	0.007	0.008	0.009	0.011	
				RPM	18144	15650	13581	11618	9549	8594	7730	6844	
K	15-20	Grey cast iron Nodular cast iron Malleable cast iron	0.05D	2D	Vc	87	93	104	113	118	125	132	135
					fz	0.003	0.003	0.004	0.004	0.006	0.006	0.008	0.01
					RPM	27693	24669	22069	17985	15024	13263	12005	10743
H	38.1 - 38.2	Hardened steel	0.02D	2D	Vc	35	37	40	45	48	50	53	54
					fz	0.003	0.003	0.004	0.005	0.005	0.006	0.007	0.008
					RPM	11141	9815	8488	7162	6112	5305	4820	4297
	40	Chilled Cast Iron	0.05D	2D	Vc	57	59	64	73	75	81	85	86
					fz	0.003	0.004	0.004	0.005	0.007	0.008	0.009	0.011
					RPM	18144	15650	13581	11618	9549	8594	7730	6844
	41	Hardened Cast Iron	0.02D	2D	Vc	35	37	40	45	48	50	53	54
					fz	0.003	0.003	0.004	0.005	0.005	0.006	0.007	0.008
					RPM	11141	9815	8488	7162	6112	5305	4820	4297

▶ NEXT PAGE

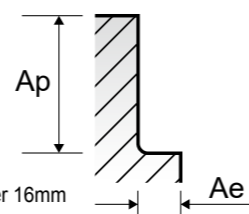

SEME01 SERIES 4 FLUTE CORNER RADIUS - SIDE CUTTING

Vc = m/min.
fz = mm/tooth
RPM = rev./min.
FEED = mm/min.

VDI 3323	Parameter	Diameter (Ø)											
		4.5	5.0	5.5	6.0	7.0	8.0	10.0	11.0	12.0	14.0	16.0	20.0
1-5	Vc	141	144	147	149	153	151	158	158	155	159	156	158
	fz	0.011	0.012	0.013	0.014	0.016	0.019	0.023	0.022	0.022	0.022	0.023	0.023
	RPM	9974	9167	8508	7905	6957	6008	5029	4572	4112	3615	3104	2515
	FEED	439	440	442	443	445	457	463	402	362	318	286	231
6-8	Vc	141	144	147	149	153	151	158	158	155	159	156	158
	fz	0.011	0.012	0.013	0.014	0.016	0.019	0.023	0.022	0.022	0.022	0.023	0.023
	RPM	9974	9167	8508	7905	6957	6008	5029	4572	4112	3615	3104	2515
	FEED	439	440	442	443	445	457	463	402	362	318	286	231
9	Vc	89	91	94	95	97	96	103	105	105	107	106	103
	fz	0.013	0.016	0.017	0.018	0.02	0.024	0.027	0.028	0.029	0.028	0.027	0.027
	RPM	6295	5793	5440	5040	4411	3820	3279	3038	2785	2433	2109	1639
	FEED	327	371	370	363	353	367	354	340	323	272	228	177
10 - 11.1	Vc	141	144	147	149	153	151	158	158	155	159	156	158
	fz	0.011	0.012	0.013	0.014	0.016	0.019	0.023	0.022	0.022	0.022	0.023	0.023
	RPM	9974	9167	8508	7905	6957	6008	5029	4572	4112	3615	3104	2515
	FEED	439	440	442	443	445	457	463	402	362	318	286	231
11.2	Vc	89	91	94	95	97	96	103	105	105	107	106	103
	fz	0.013	0.016	0.017	0.018	0.02	0.024	0.027	0.028	0.029	0.028	0.027	0.027
	RPM	6295	5793	5440	5040	4411	3820	3279	3038	2785	2433	2109	1639
	FEED	327	371	370	363	353	367	354	340	323	272	228	177
15 - 20	Vc	141	144	147	149	153	151	158	158	155	159	156	158
	fz	0.011	0.012	0.013	0.014	0.016	0.019	0.023	0.022	0.022	0.022	0.023	0.023
	RPM	9974	9167	8508	7905	6957	6008	5029	4572	4112	3615	3104	2515
	FEED	439	440	442	443	445	457	463	402	362	318	286	231
38.1 - 38.2	Vc	57	60	61	62	64	63	63	64	63	65	64	63
	fz	0.01	0.011	0.012	0.013	0.015	0.017	0.021	0.021	0.021	0.021	0.022	0.023
	RPM	4032	3820	3530	3289	2910	2507	2005	1852	1671	1478	1273	1003
	FEED	161	168	169	171	175	170	168	156	140	124	112	92
40	Vc	89	91	94	95	97	96	103	105	105	107	106	103
	fz	0.013	0.016	0.017	0.018	0.02	0.024	0.027	0.028	0.029	0.028	0.027	0.027
	RPM	6295	5793	5440	5040	4411	3820	3279	3038	2785	2433	2109	1639
	FEED	327	371	370	363	353	367	354	340	323	272	228	177
41	Vc	57	60	61	62	64	63	63	64	63	65	64	63
	fz	0.01	0.011	0.012	0.013	0.015	0.017	0.021	0.021	0.021	0.021	0.022	0.023
	RPM	4032	3820	3530	3289	2910	2507	2005	1852	1671	1478	1273	1003
	FEED	161	168	169	171	175	170	168	156	140	124	112	92

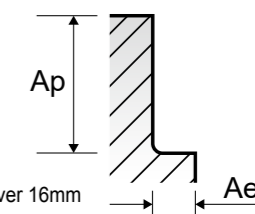



RECOMMENDED CUTTING CONDITIONS
EMPFOHLENE SCHNEIDPARAMETER

SEME64 SERIES 4 FLUTE CORNER RADIUS - SIDE CUTTING

Vc = m/min. fz = mm/tooth
RPM = rev./min. FEED = mm/min.
Ae = mm LBS = Length Below Shank

Table with columns for ISO, VDI 3323, Material Description, Parameter, and Diameter (Ø) ranging from 1.0 to 2.5. Rows include material types like Non-alloy steel, Low alloy steel, High alloyed steel, and Grey cast iron.

▶ NEXT PAGE

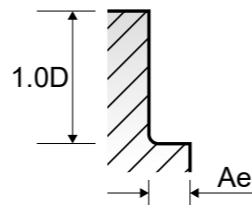

RECOMMENDED CUTTING CONDITIONS
EMPFOHLENE SCHNEIDPARAMETER

SEME64 SERIES 4 FLUTE CORNER RADIUS - SIDE CUTTING

Vc = m/min. fz = mm/tooth
RPM = rev./min. FEED = mm/min.
Ae = mm LBS = Length Below Shank

Table with columns for VDI 3323, Parameter, and Diameter (Ø) ranging from 1.2 to 2.5. Rows include material types like Non-alloy steel, Low alloy steel, High alloyed steel, and Grey cast iron.

▶ NEXT PAGE

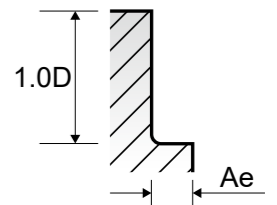



RECOMMENDED CUTTING CONDITIONS
EMPFOHLENE SCHNEIDPARAMETER

SEME64 SERIES 4 FLUTE CORNER RADIUS - SIDE CUTTING

Vc = m/min. fz = mm/tooth
RPM = rev./min. FEED = mm/min.
Ae = mm LBS = Length Below Shank

Table with columns for ISO, VDI 3323, Parameter, Diameter (Ø), and various cutting parameters (Vc, fz, RPM, FEED, Ae) for different materials and diameters.

▶ NEXT PAGE

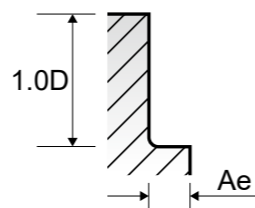

RECOMMENDED CUTTING CONDITIONS
EMPFOHLENE SCHNEIDPARAMETER

SEME64 SERIES 4 FLUTE CORNER RADIUS - SIDE CUTTING

Vc = m/min. fz = mm/tooth
RPM = rev./min. FEED = mm/min.
Ae = mm LBS = Length Below Shank

Table with columns for VDI 3323, Parameter, Diameter (Ø), and various cutting parameters (Vc, fz, RPM, FEED, Ae) for different materials and diameters.

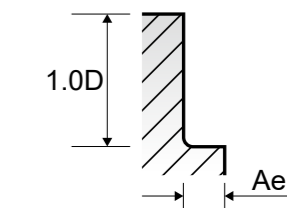

SEME35 SERIES 2 FLUTE - SLOTTING

Vc = m/min.
fz = mm/tooth
RPM = rev./min.
FEED = mm/min.

ISO	VDI 3323	Ae	Ap	Parameter	Diameter (Ø)										
					7.5	8.0	8.5	9.0	9.5	10.0	10.5	11.0	11.5	12.0	
P	1-5	1.0D	0.5D (up to Ø3: 0.2D) (up to Ø1: 0.15D)	Vc	107	106	106	105	104	102	103	104	104	103	
				fz	0.043	0.048	0.049	0.05	0.051	0.053	0.053	0.053	0.053	0.053	0.054
				RPM	4541	4218	3970	3714	3485	3247	3122	3009	2879	2732	2732
				FEED	391	405	389	371	355	344	331	319	305	295	295
				Vc	107	106	106	105	104	102	103	104	104	103	103
				fz	0.043	0.048	0.049	0.05	0.051	0.053	0.053	0.053	0.053	0.053	0.054
	6-8	1.0D	0.5D (up to Ø3: 0.2D) (up to Ø1: 0.15D)	Vc	64	63	64	64	64	63	63	64	64	63	
				fz	0.039	0.042	0.042	0.042	0.042	0.043	0.042	0.041	0.04	0.04	
				RPM	2716	2507	2397	2264	2144	2005	1910	1852	1771	1671	
				FEED	212	211	201	190	180	172	160	152	142	134	134
				Vc	107	106	106	105	104	102	103	104	104	103	103
				fz	0.043	0.048	0.049	0.05	0.051	0.053	0.053	0.053	0.053	0.053	0.054
9	1.0D	0.5D (up to Ø3: 0.2D) (up to Ø1: 0.15D)	Vc	64	63	64	64	64	63	63	64	64	63		
			fz	0.039	0.042	0.042	0.042	0.042	0.043	0.042	0.041	0.04	0.04		
			RPM	2716	2507	2397	2264	2144	2005	1910	1852	1771	1671		
			FEED	212	211	201	190	180	172	160	152	142	134	134	
			Vc	107	106	106	105	104	102	103	104	104	103	103	
			fz	0.043	0.048	0.049	0.05	0.051	0.053	0.053	0.053	0.053	0.053	0.054	
10 - 11.1	1.0D	0.5D (up to Ø3: 0.2D) (up to Ø1: 0.15D)	Vc	64	63	64	64	64	63	63	64	64	63		
			fz	0.039	0.042	0.042	0.042	0.042	0.043	0.042	0.041	0.04	0.04		
			RPM	2716	2507	2397	2264	2144	2005	1910	1852	1771	1671		
			FEED	212	211	201	190	180	172	160	152	142	134	134	
			Vc	64	63	64	64	64	63	63	64	64	63	63	
			fz	0.039	0.042	0.042	0.042	0.042	0.043	0.042	0.041	0.04	0.04	0.04	
11.2	1.0D	0.5D (up to Ø3: 0.2D) (up to Ø1: 0.15D)	Vc	2716	2507	2397	2264	2144	2005	1910	1852	1771	1671		
			fz	212	211	201	190	180	172	160	152	142	134	134	
			Vc	54	53	53	53	53	53	53	53	52	51	51	
			fz	0.042	0.045	0.046	0.048	0.049	0.051	0.05	0.049	0.049	0.05	0.05	
			RPM	2292	2109	1985	1874	1776	1687	1607	1534	1439	1353	1353	
			FEED	193	190	183	180	174	172	161	150	141	135	135	
M	14.1	1.0D	0.5D (up to Ø1: 0.02D)	Vc	107	106	106	105	104	102	103	104	104	103	
				fz	0.043	0.048	0.049	0.05	0.051	0.053	0.053	0.053	0.053	0.053	0.054
				RPM	4541	4218	3970	3714	3485	3247	3122	3009	2879	2732	2732
				FEED	391	405	389	371	355	344	331	319	305	295	295
				Vc	107	106	106	105	104	102	103	104	104	103	103
				fz	0.043	0.048	0.049	0.05	0.051	0.053	0.053	0.053	0.053	0.053	0.054
K	15-20	1.0D	0.5D (up to Ø3: 0.2D) (up to Ø1: 0.15D)	Vc	41	42	43	43	43	43	43	44	44	44	
				fz	0.021	0.024	0.023	0.022	0.022	0.023	0.023	0.023	0.024	0.025	0.025
				RPM	1740	1671	1610	1521	1441	1369	1304	1273	1218	1167	1167
				FEED	73	80	74	67	63	60	59	58	58	58	58
				Vc	64	63	64	64	64	63	63	64	64	63	63
				fz	0.039	0.042	0.042	0.042	0.042	0.043	0.042	0.041	0.04	0.04	0.04
H	38.1 - 38.2	1.0D	0.05D (up to Ø1: 0.02D)	Vc	2716	2507	2397	2264	2144	2005	1910	1852	1771	1671	
				fz	212	211	201	190	180	172	160	152	142	134	134
				Vc	41	42	43	43	43	43	43	44	44	44	44
				fz	0.021	0.024	0.023	0.022	0.022	0.023	0.023	0.023	0.024	0.025	0.025
				RPM	1740	1671	1610	1521	1441	1369	1304	1273	1218	1167	1167
				FEED	73	80	74	67	63	60	59	58	58	58	58

▶ NEXT PAGE

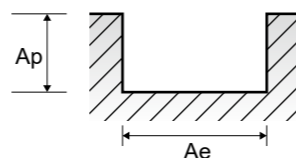

SEME35 SERIES 2 FLUTE - SLOTTING

Vc = m/min.
fz = mm/tooth
RPM = rev./min.
FEED = mm/min.

VDI 3323	Parameter	Diameter (Ø)												
		13.0	14.0	15.0	16.0	17.0	18.0	19.0	20.0	21.0	22.0	23.0	24.0	25.0
1-5	Vc	106	109	110	111	111	110	108	106	107	107	107	107	107
	fz	0.054	0.054	0.052	0.052	0.052	0.053	0.052	0.054	0.053	0.053	0.051	0.049	0.05
	RPM	2595	2478	2334	2208	2078	1945	1809	1687	1622	1548	1481	1419	1362
	FEED	280	268	243	230	216	206	188	182	172	164	151	139	136
6-8	Vc	106	109	110	111	111	110	108	106	107	107	107	107	107
	fz	0.054	0.054	0.052	0.052	0.052	0.053	0.052	0.054	0.053	0.053	0.051	0.049	0.05
	RPM	2595	2478	2334	2208	2078	1945	1809	1687	1622	1548	1481	1419	1362
	FEED	280	268	243	230	216	206	188	182	172	164	151	139	136
9	Vc	65	67	68	68	69	68	68	67	67	67	67	67	66
	fz	0.041	0.041	0.042	0.042	0.041	0.041	0.041	0.04	0.04	0.04	0.041	0.042	0.043
	RPM	1592	1523	1443	1353	1292	1203	1139	1066	1016	969	927	889	840
	FEED	131	125	121	114	106	99	91	85	81	79	78	76	74
10 - 11.1	Vc	106	109	110	111	111	110	108	106	107	107	107	107	107
	fz	0.054	0.054	0.052	0.052	0.052	0.053	0.052	0.054	0.053	0.053	0.051	0.049	0.05
	RPM	2595	2478	2334	2208	2078	1945	1809	1687	1622	1548	1481	1419	1362
	FEED	280	268	243	230	216	206	188	182	172	164	151	139	136
11.2	Vc	65	67	68	68	69	68	68	67	67	67	67	67	66
	fz	0.041	0.041	0.042	0.042	0.041	0.041	0.041	0.04	0.04	0.04	0.041	0.042	0.043
	RPM	1592	1523	1443	1353	1292	1203	1139	1066	1016	969	927	889	840
	FEED	131	125	121	114	106	99	91	85	81	79	78	76	74
14.1	Vc	52	53	53	53	54	54	53	53	53	54	54	54	53
	fz	0.051	0.052	0.053	0.054	0.052	0.053	0.05	0.05	0.05	0.049	0.048	0.047	0.046
	RPM	1273	1205	1125	1054	1011	955	888	844	803	781	747	716	675
	FEED	130	125	119	114	105	101	89	84	80	77	72	67	62
15 - 20	Vc	106	109	110	111	111	110	108	106	107	107	107	107	107
	fz	0.054	0.054	0.052	0.052	0.052	0.053	0.052	0.054	0.053	0.053	0.051	0.049	0.05
	RPM	2595	2478	2334	2208	2078	1945	1809	1687	1622	1548	1481	1419	1362
	FEED	280	268	243	230	216	206	188	182	172	164	151	139	136
38.1 - 38.2	Vc	45	45	45	45	45	45	44	43	43	43	43	43	42
	fz	0.025	0.024	0.023	0.023	0.023	0.023	0.023	0.024	0.022	0.022	0.021	0.02	0.019
	RPM	1102	1023	955	895	843	796	737	684	652	622	595	570	535
	FEED	55	49	44	41	39	37	34	33	29	27	25	23	20
40	Vc	65	67	68	68	69	68	68	67	67	67	67	67	66
	fz	0.041	0.041	0.042	0.042	0.041	0.041	0.041	0.04	0.04	0.04	0.041	0.042	0.043
	RPM	1592	1523	1443	1353	1292	1203	1139	1066	1016	969	927	889	840
	FEED	131	125	121	114	106	99	91	85	81	79	78	76	74
41	Vc	45	45	45	45	45	45	44	43	43	43	43	43	42
	fz	0.025	0.024	0.023	0.023	0.023	0.023	0.023	0.024	0.022	0.022	0.021	0.02	0.019
	RPM	1102	1023	955	895	843	796	737	684	652	622	595	570	535
	FEED	55	49	44	41	39	37	34	33	29	27	25	23	20

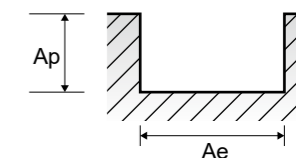

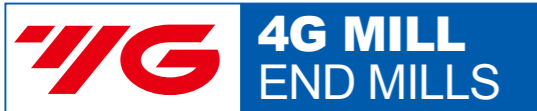

RECOMMENDED CUTTING CONDITIONS
EMPFOHLENE SCHNEIDPARAMETER

SEME70 SERIES 2 FLUTE - SLOTTING

Vc = m/min. fz = mm/tooth
RPM = rev./min. FEED = mm/min.
LOC = Length of Cut

Table with columns for ISO, VDI 3323, Material Description, Ae, Ap, Parameter, and Diameter (Ø) from 1.0 to 1.2. Rows include materials like Non-alloy steel, Low alloy steel, High alloyed steel, and various cast irons.

▶ NEXT PAGE

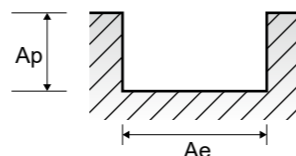

RECOMMENDED CUTTING CONDITIONS
EMPFOHLENE SCHNEIDPARAMETER

SEME70 SERIES 2 FLUTE - SLOTTING

Vc = m/min. fz = mm/tooth
RPM = rev./min. FEED = mm/min.
LOC = Length of Cut

Table with columns for VDI 3323, Parameter, and Diameter (Ø) from 1.2 to 3.0. Rows include materials like Non-alloy steel, Low alloy steel, High alloyed steel, and various cast irons.

▶ NEXT PAGE

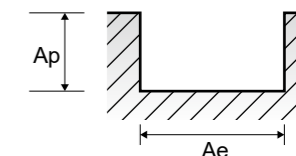

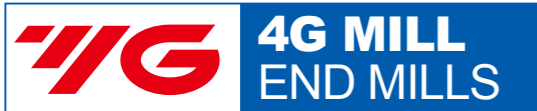

**RECOMMENDED CUTTING CONDITIONS
EMPFOHLENE SCHNEIDPARAMETER**

SEME70 SERIES 2 FLUTE - SLOTTING

Vc = m/min. fz = mm/tooth
RPM = rev./min. FEED = mm/min.
LOC = Length of Cut

ISO	VDI 3323	Ae	Ap	Parameter	Diameter (Ø)																
					3.0	3.0	3.0	3.0	4.0	4.0	4.0	4.0	5.0	5.0	5.0	5.0	5.0	5.0	6.0		
					LOC	16	20	26	30	12	16	20	26	30	20	25	30	35	40	15	
P	1-5	1.0D	0.3D (up to Ø3:0.4mm)	Vc	54	54	54	54	65	65	65	58	58	69	69	62	62	62	62	72	
				fz	0.008	0.007	0.006	0.006	0.012	0.012	0.012	0.01	0.01	0.017	0.017	0.015	0.015	0.014	0.014	0.024	
				RPM	5730	5730	5730	5730	5173	5173	5173	4615	4615	4393	4393	3947	3947	3947	3947	3820	
				FEED	92	80	69	69	124	124	124	92	92	149	149	118	118	111	111	183	
				Vc	54	54	54	54	65	65	65	58	58	69	69	62	62	62	62	72	
				fz	0.008	0.007	0.006	0.006	0.012	0.012	0.012	0.01	0.01	0.017	0.017	0.015	0.015	0.014	0.014	0.024	
	RPM	5730	5730	5730	5730	5173	5173	5173	4615	4615	4393	4393	3947	3947	3947	3947	3820				
	FEED	92	80	69	69	124	124	124	92	92	149	149	118	118	111	111	183				
	6-8	1.0D	0.3D (up to Ø3:0.4mm)	Vc	44	44	44	44	52	52	52	46	46	55	55	49	49	49	49	57	
				fz	0.008	0.008	0.006	0.006	0.012	0.012	0.012	0.012	0.012	0.018	0.018	0.016	0.016	0.014	0.014	0.025	
				RPM	4669	4669	4669	4669	4138	4138	4138	3661	3661	3501	3501	3119	3119	3119	3119	3024	
				FEED	75	75	56	56	99	99	99	88	88	126	126	100	100	87	87	151	
Vc				54	54	54	54	65	65	65	58	58	69	69	62	62	62	62	72		
fz				0.008	0.007	0.006	0.006	0.012	0.012	0.012	0.01	0.01	0.017	0.017	0.015	0.015	0.014	0.014	0.024		
RPM	5730	5730	5730	5730	5173	5173	5173	4615	4615	4393	4393	3947	3947	3947	3947	3820					
FEED	92	80	69	69	124	124	124	92	92	149	149	118	118	111	111	183					
9	1.0D	0.3D (up to Ø3:0.4mm)	Vc	44	44	44	44	52	52	52	46	46	55	55	49	49	49	49	57		
			fz	0.008	0.008	0.006	0.006	0.012	0.012	0.012	0.012	0.012	0.018	0.018	0.016	0.016	0.014	0.014	0.025		
			RPM	4669	4669	4669	4669	4138	4138	4138	3661	3661	3501	3501	3119	3119	3119	3119	3024		
			FEED	75	75	56	56	99	99	99	88	88	126	126	100	100	87	87	151		
			Vc	54	54	54	54	65	65	65	58	58	69	69	62	62	62	62	72		
			fz	0.008	0.007	0.006	0.006	0.012	0.012	0.012	0.01	0.01	0.017	0.017	0.015	0.015	0.014	0.014	0.024		
RPM	5730	5730	5730	5730	5173	5173	5173	4615	4615	4393	4393	3947	3947	3947	3947	3820					
FEED	92	80	69	69	124	124	124	92	92	149	149	118	118	111	111	183					
10-11.1	1.0D	0.3D (up to Ø3:0.4mm)	Vc	44	44	44	44	52	52	52	46	46	55	55	49	49	49	49	57		
			fz	0.008	0.008	0.006	0.006	0.012	0.012	0.012	0.012	0.012	0.018	0.018	0.016	0.016	0.014	0.014	0.025		
			RPM	4669	4669	4669	4669	4138	4138	4138	3661	3661	3501	3501	3119	3119	3119	3119	3024		
			FEED	75	75	56	56	99	99	99	88	88	126	126	100	100	87	87	151		
			Vc	54	54	54	54	65	65	65	58	58	69	69	62	62	62	62	72		
			fz	0.008	0.007	0.006	0.006	0.012	0.012	0.012	0.01	0.01	0.017	0.017	0.015	0.015	0.014	0.014	0.024		
RPM	5730	5730	5730	5730	5173	5173	5173	4615	4615	4393	4393	3947	3947	3947	3947	3820					
FEED	92	80	69	69	124	124	124	92	92	149	149	118	118	111	111	183					
11.2	1.0D	0.3D (up to Ø3:0.4mm)	Vc	44	44	44	44	52	52	52	46	46	55	55	49	49	49	49	57		
			fz	0.008	0.008	0.006	0.006	0.012	0.012	0.012	0.012	0.012	0.018	0.018	0.016	0.016	0.014	0.014	0.025		
			RPM	4669	4669	4669	4669	4138	4138	4138	3661	3661	3501	3501	3119	3119	3119	3119	3024		
			FEED	75	75	56	56	99	99	99	88	88	126	126	100	100	87	87	151		
			Vc	54	54	54	54	65	65	65	58	58	69	69	62	62	62	62	72		
			fz	0.008	0.007	0.006	0.006	0.012	0.012	0.012	0.01	0.01	0.017	0.017	0.015	0.015	0.014	0.014	0.024		
RPM	5730	5730	5730	5730	5173	5173	5173	4615	4615	4393	4393	3947	3947	3947	3947	3820					
FEED	92	80	69	69	124	124	124	92	92	149	149	118	118	111	111	183					
K	15-20	1.0D	0.3D (up to Ø3:0.4mm)	Vc	54	54	54	54	65	65	65	58	58	69	69	62	62	62	72		
				fz	0.008	0.007	0.006	0.006	0.012	0.012	0.012	0.01	0.01	0.017	0.017	0.015	0.015	0.014	0.014	0.024	
				RPM	5730	5730	5730	5730	5173	5173	5173	4615	4615	4393	4393	3947	3947	3947	3947	3820	
				FEED	92	80	69	69	124	124	124	92	92	149	149	118	118	111	111	183	
				Vc	27	27	27	27	32	32	32	29	29	36	36	32	32	32	32	37	
				fz	0.007	0.006	0.005	0.005	0.01	0.01	0.01	0.009	0.009	0.012	0.012	0.011	0.011	0.01	0.01	0.018	
RPM	2865	2865	2865	2865	2546	2546	2546	2308	2308	2292	2292	2037	2037	2037	2037	1963					
FEED	40	34	29	29	51	51	51	42	42	55	55	45	45	41	41	71					
H	38.1 - 38.2	1.0D	0.05D	Vc	44	44	44	44	52	52	52	46	46	55	55	49	49	49	49	57	
				fz	0.008	0.008	0.006	0.006	0.012	0.012	0.012	0.012	0.012	0.018	0.018	0.016	0.016	0.014	0.014	0.025	
				RPM	4669	4669	4669	4669	4138	4138	4138	3661	3661	3501	3501	3119	3119	3119	3119	3024	
				FEED	75	75	56	56	99	99	99	88	88	126	126	100	100	87	87	151	
				Vc	44	44	44	44	52	52	52	46	46	55	55	49	49	49	49	57	
				fz	0.008	0.008	0.006	0.006	0.012	0.012	0.012	0.012	0.012	0.018	0.018	0.016	0.016	0.014	0.014	0.025	
RPM	4669	4669	4669	4669	4138	4138	4138	3661	3661	3501	3501	3119	3119	3119	3119	3024					
FEED	75	75	56	56	99	99	99	88	88	126	126	100	100	87	87	151					
40	1.0D	0.3D (up to Ø3:0.4mm)	Vc	44	44	44	44	52	52	52	46	46	55	55	49	49	49	49	57		
			fz	0.008	0.008	0.006	0.006	0.012	0.012	0.012	0.012	0.012	0.018	0.018	0.016	0.016	0.014	0.014	0.025		
			RPM	4669	4669	4669	4669	4138	4138	4138	3661	3661	3501	3501	3119	3119	3119	3119	3024		
			FEED	75	75	56	56	99	99	99	88	88	126	126	100	100	87	87	151		
			Vc	27	27	27	27	32	32	32	29	29	36	36	32	32	32	32	37		
			fz	0.007	0.006	0.005	0.005	0.01	0.01	0.01	0.009	0.009	0.012	0.012	0.011	0.011	0.01	0.01	0.018		
RPM	2865	2865	2865	2865	2546	2546	2546	2308	2308	2292	2292	2037	2037	2037	2037	1963					
FEED	40	34	29	29	51	51	51	42	42	55	55	45	45	41	41	71					
41	1.0D	0.05D	Vc	27	27	27	27	32	32	32	29	29	36	36	32	32	32	37			
			fz	0.007	0.006	0.005	0.005	0.01	0.01	0.01	0.009	0.009	0.012	0.012	0.011	0.011	0.01	0.01	0.018		
			RPM	2865	2865	2865	2865	2546	2546	2546	2308	2308	2292	2292	2037	2037	2037	2037	1963		
			FEED	40	34	29	29	51	51	51	42	42	55	55	45	45	41	41	71		

▶ NEXT PAGE

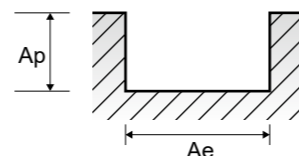

**RECOMMENDED CUTTING CONDITIONS
EMPFOHLENE SCHNEIDPARAMETER**

SEME70 SERIES 2 FLUTE - SLOTTING

Vc = m/min. fz = mm/tooth
RPM = rev./min. FEED = mm/min.
LOC = Length of Cut

VDI 3323	Parameter	Diameter (Ø)																							
		6.0	6.0	6.0	6.0	6.0	6.0	6.0	8.0	8.0	8.0	8.0	8.0	8.0	10.0	10.0	10.0	10.0	10.0	10.0	10.0	10.0	12.0		
		LOC	20	25	30	35	40	45	25	30	35	40	45	50	30	35	40	45	50	55	60</				

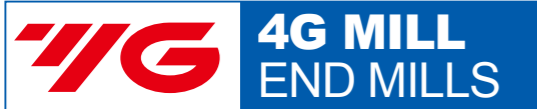

RECOMMENDED CUTTING CONDITIONS
EMPFOHLENE SCHNEIDPARAMETER

SEME70 SERIES 2 FLUTE - SLOTTING

Vc = m/min. fz = mm/tooth
RPM = rev./min. FEED = mm/min.
LOC = Length of Cut

ISO	VDI 3323	Ae	Ap	Parameter	Diameter (Ø)															
					LOC															
					12.0	12.0	12.0	12.0	12.0	12.0	12.0	14.0	14.0	16.0	16.0	16.0	16.0	16.0	16.0	16.0
P	1-5	1.0D	0.3D (up to Ø3:0.4mm)	Vc	75	75	75	75	75	68	68	81	81	85	85	85	85	85		
				fz	0.038	0.033	0.033	0.033	0.028	0.028	0.028	0.034	0.034	0.041	0.041	0.035	0.035	0.031		
				RPM	1989	1989	1989	1989	1804	1804	1842	1842	1691	1691	1691	1691	1691	1691	1691	
				FEED	151	131	131	131	111	101	101	125	125	139	139	118	118	105	105	
				Vc	75	75	75	75	75	68	68	81	81	85	85	85	85	85	85	
				fz	0.038	0.033	0.033	0.033	0.028	0.028	0.028	0.034	0.034	0.041	0.041	0.035	0.035	0.031	0.031	
	RPM	1989	1989	1989	1989	1804	1804	1842	1842	1691	1691	1691	1691	1691	1691	1691				
	FEED	151	131	131	131	111	101	101	125	125	139	139	118	118	105	105				
	6-8	1.0D	0.3D (up to Ø3:0.4mm)	Vc	63	63	63	63	63	57	57	65	65	64	64	64	64	64		
				fz	0.04	0.034	0.034	0.034	0.03	0.03	0.03	0.034	0.034	0.041	0.041	0.035	0.035	0.031		
				RPM	1671	1671	1671	1671	1671	1512	1512	1478	1478	1273	1273	1273	1273	1273		
				FEED	134	114	114	114	100	91	91	100	104	104	89	89	79	79	79	
Vc				75	75	75	75	75	68	68	81	81	85	85	85	85	85	85		
fz				0.038	0.033	0.033	0.033	0.028	0.028	0.028	0.034	0.034	0.041	0.041	0.035	0.035	0.031	0.031		
RPM	1989	1989	1989	1989	1804	1804	1842	1842	1691	1691	1691	1691	1691	1691	1691					
FEED	151	131	131	131	111	101	101	125	125	139	139	118	118	105	105					
9	1.0D	0.3D (up to Ø3:0.4mm)	Vc	63	63	63	63	63	57	57	65	65	64	64	64	64	64			
			fz	0.04	0.034	0.034	0.034	0.03	0.03	0.03	0.034	0.034	0.041	0.041	0.035	0.035	0.031			
			RPM	1671	1671	1671	1671	1671	1512	1512	1478	1478	1273	1273	1273	1273	1273			
			FEED	134	114	114	114	100	91	91	100	104	104	89	89	79	79	79		
			Vc	75	75	75	75	75	68	68	81	81	85	85	85	85	85	85		
			fz	0.038	0.033	0.033	0.033	0.028	0.028	0.028	0.034	0.034	0.041	0.041	0.035	0.035	0.031	0.031		
RPM	1989	1989	1989	1989	1804	1804	1842	1842	1691	1691	1691	1691	1691	1691	1691					
FEED	151	131	131	131	111	101	101	125	125	139	139	118	118	105	105					
10-11.1	1.0D	0.3D (up to Ø3:0.4mm)	Vc	63	63	63	63	63	57	57	65	65	64	64	64	64	64			
			fz	0.04	0.034	0.034	0.034	0.03	0.03	0.03	0.034	0.034	0.041	0.041	0.035	0.035	0.031			
			RPM	1671	1671	1671	1671	1671	1512	1512	1478	1478	1273	1273	1273	1273	1273			
			FEED	134	114	114	114	100	91	91	100	104	104	89	89	79	79	79		
			Vc	75	75	75	75	75	68	68	81	81	85	85	85	85	85	85		
			fz	0.038	0.033	0.033	0.033	0.028	0.028	0.028	0.034	0.034	0.041	0.041	0.035	0.035	0.031	0.031		
RPM	1989	1989	1989	1989	1804	1804	1842	1842	1691	1691	1691	1691	1691	1691	1691					
FEED	151	131	131	131	111	101	101	125	125	139	139	118	118	105	105					
11.2	1.0D	0.3D (up to Ø3:0.4mm)	Vc	63	63	63	63	63	57	57	65	65	64	64	64	64	64			
			fz	0.04	0.034	0.034	0.034	0.03	0.03	0.03	0.034	0.034	0.041	0.041	0.035	0.035	0.031			
			RPM	1671	1671	1671	1671	1671	1512	1512	1478	1478	1273	1273	1273	1273	1273			
			FEED	134	114	114	114	100	91	91	100	104	104	89	89	79	79	79		
			Vc	75	75	75	75	75	68	68	81	81	85	85	85	85	85	85		
			fz	0.038	0.033	0.033	0.033	0.028	0.028	0.028	0.034	0.034	0.041	0.041	0.035	0.035	0.031	0.031		
RPM	1989	1989	1989	1989	1804	1804	1842	1842	1691	1691	1691	1691	1691	1691	1691					
FEED	151	131	131	131	111	101	101	125	125	139	139	118	118	105	105					
K	15-20	1.0D	0.3D (up to Ø3:0.4mm)	Vc	75	75	75	75	75	68	68	81	81	85	85	85	85			
				fz	0.038	0.033	0.033	0.033	0.028	0.028	0.028	0.034	0.034	0.041	0.041	0.035	0.035	0.031		
				RPM	1989	1989	1989	1989	1804	1804	1842	1842	1691	1691	1691	1691	1691	1691		
				FEED	151	131	131	131	111	101	101	125	125	139	139	118	118	105		
				Vc	38	38	38	38	38	34	34	40	40	40	40	40	40	40	40	
				fz	0.027	0.022	0.022	0.022	0.02	0.019	0.019	0.025	0.025	0.031	0.031	0.025	0.025	0.022	0.022	
RPM	1008	1008	1008	1008	1008	902	902	909	909	796	796	796	796	796	796					
FEED	54	44	44	44	40	34	34	45	45	49	49	40	40	35	35					
H	38.1 - 38.2	1.0D	0.05D	Vc	63	63	63	63	63	57	57	65	65	64	64	64	64			
				fz	0.04	0.034	0.034	0.034	0.03	0.03	0.03	0.034	0.034	0.041	0.041	0.035	0.035	0.031		
				RPM	1671	1671	1671	1671	1671	1512	1512	1478	1478	1273	1273	1273	1273	1273		
				FEED	134	114	114	114	100	91	91	100	104	104	89	89	79	79	79	
				Vc	38	38	38	38	38	34	34	40	40	40	40	40	40	40	40	
				fz	0.027	0.022	0.022	0.022	0.02	0.019	0.019	0.025	0.025	0.031	0.031	0.025	0.025	0.022	0.022	
RPM	1008	1008	1008	1008	1008	902	902	909	909	796	796	796	796	796	796					
FEED	54	44	44	44	40	34	34	45	45	49	49	40	40	35	35					

▶ NEXT PAGE

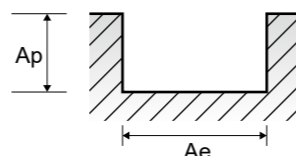

RECOMMENDED CUTTING CONDITIONS
EMPFOHLENE SCHNEIDPARAMETER

SEME70 SERIES 2 FLUTE - SLOTTING

Vc = m/min. fz = mm/tooth
RPM = rev./min. FEED = mm/min.
LOC = Length of Cut

VDI 3323	Parameter	Diameter (Ø)																			
		LOC																			
		16.0	16.0	16.0	18.0	18.0	18.0	20.0	20.0	20.0	20.0	20.0	20.0	20.0	22.0	22.0	25.0	25.0	25.0	25.0	
1-5	Vc	77	77	77	82	82	74	77	77	77	77	69	69	76	76	77	77	77	77		
	fz	0.031	0.031	0.031	0.041	0.034	0.031	0.041	0.041	0.035	0.035	0.031	0.032	0.032	0.034	0.032	0.041	0.036	0.036		
	RPM	1532	1532	1532	1450	1450	1309	1225	1225	1225	1225	1100	1098	1098	1100	1100	980	980	980		
	FEED	95	95	95	119	99	81	100	100	86	86	76	70	70	75	70	80	71	71		
	Vc	77	77	77	82	82	74	77	77	77	77	69	69	76	76	77	77	77	77		
	fz	0.031	0.031	0.031	0.041	0.034	0.031	0.041	0.041	0.035	0.035	0.031	0.032	0.032	0.034	0.032	0.041	0.036	0.036		
6-8	Vc	77	77	77	82	82	74	77	77	77	69	69	76	76	77	77	77	77			
	fz	0.031	0.031	0.031	0.041	0.034	0.031	0.041	0.041	0.035	0.035	0.031	0.032	0.032	0.034	0.032	0.041	0.036			
	RPM	1532	1532	1532	1450	1450	1309	1225	1225	1225	1225	1098	1098	1100	1100	980	980	980			
	FEED	95	95	95	119	99	81	100	100	86	86	76	70	70	75	70	80	71			
	Vc	58	58	58	63	63	57	60	60	60	60	54	54	58	58	59	59	59	59		
	fz	0.03	0.03	0.03	0.04	0.033	0.03	0.039	0.039	0.034	0.034	0.029	0.029	0.029	0.033	0.03	0.04	0.033	0.033		
9	Vc	58	58	58	63	63	57	60	60	60	54	54	58	58	59	59	59	59			
	fz	0.03	0.03	0.03	0.04	0.033	0.03	0.039	0.039	0.034	0.034	0.029	0.029	0.029	0.033	0.03	0.04	0.033			
	RPM	1154	1154	1154	1114	1114	1008	955	955	955	955	859	859	859	839	839	751	751			
	FEED	69	69	69	89	74	60	74	74	65	65	55	50	50	55	50	60	50			
	Vc	77	77	77	82	82	74	77	77	77	77	69	69	76	76	77	77	77	77		
	fz	0.031	0.031	0.031	0.041	0.034	0.031	0.041	0.041	0.035	0.035	0.031	0.032	0.032	0.034	0.032	0.041	0.036			
10 - 11.1	Vc	77	77	77																	

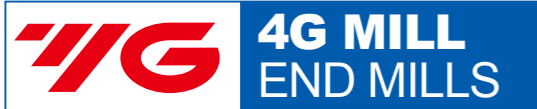

RECOMMENDED CUTTING CONDITIONS EMPFOHLENE SCHNEIDPARAMETER



RECOMMENDED CUTTING CONDITIONS EMPFOHLENE SCHNEIDPARAMETER

SEM845 SERIES 2 FLUTE - SLOTTING

Vc = m/min. fz = mm/tooth
RPM = rev./min. FEED = mm/min.
Ap = mm LBS = Length Below Shank

Table with columns for ISO, VDI 3323, Material Description, Parameter (Vc, fz, RPM, FEED, Ap), and Diameter (Ø) from 0.1 to 0.4 mm.

SEM845 SERIES 2 FLUTE - SLOTTING

Vc = m/min. fz = mm/tooth
RPM = rev./min. FEED = mm/min.
Ap = mm LBS = Length Below Shank

Table with columns for VDI 3323, Parameter (Vc, fz, RPM, FEED, Ap), and Diameter (Ø) from 0.4 to 0.6 mm.

▶ NEXT PAGE

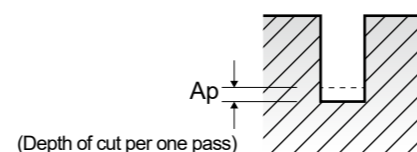

▶ NEXT PAGE

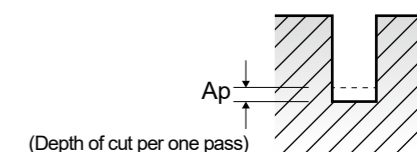

YG 4G MILL END MILLS

RECOMMENDED CUTTING CONDITIONS EMPFOHLENE SCHNEIDPARAMETER

SEM845 SERIES 2 FLUTE - SLOTTING

Vc = m/min. fz = mm/tooth
RPM = rev./min. FEED = mm/min.
Ap = mm LBS = Length Below Shank

ISO	VDI 3323	Parameter	Diameter (Ø)																							
			0.6		0.6		0.6		0.6		0.6		0.7		0.7		0.7		0.8		0.8		0.8		0.8	
			LBS	4	5	6	8	10	12	14	16	2	4	6	8	10	12	2	3	4	5	6	2	3	4	5
P	1-5	Vc	46	46	46	41	31	31	15	15	60	54	54	48	48	36	69	69	69	62	62	62	62	62	62	62
		fz	0.013	0.013	0.013	0.011	0.01	0.01	0.009	0.009	0.014	0.013	0.013	0.011	0.011	0.01	0.014	0.014	0.014	0.013	0.013	0.013	0.013	0.013	0.013	0.013
		RPM	24404	24404	24404	21751	16446	16446	7958	7958	27284	24555	24555	21827	21827	16370	27454	27454	27454	24669	24669	24669	24669	24669	24669	24669
		FEED	634	634	634	479	329	329	143	143	764	638	638	480	480	327	769	769	769	641	641	641	641	641	641	641
	Ap	0.022	0.014	0.014	0.008	0.005	0.005	0.005	0.005	0.063	0.025	0.016	0.016	0.009	0.006	0.072	0.05	0.05	0.029	0.029	0.029	0.029	0.029	0.029	0.029	
	6-8	Vc	46	46	46	41	31	31	15	15	60	54	54	48	48	36	69	69	69	62	62	62	62	62	62	62
		fz	0.013	0.013	0.013	0.011	0.01	0.01	0.009	0.009	0.014	0.013	0.013	0.011	0.011	0.01	0.014	0.014	0.014	0.013	0.013	0.013	0.013	0.013	0.013	0.013
		RPM	24404	24404	24404	21751	16446	16446	7958	7958	27284	24555	24555	21827	21827	16370	27454	27454	27454	24669	24669	24669	24669	24669	24669	24669
		FEED	634	634	634	479	329	329	143	143	764	638	638	480	480	327	769	769	769	641	641	641	641	641	641	641
	9	Vc	44	44	44	39	29	29	15	15	57	51	51	45	45	34	65	65	65	58	58	58	58	58	58	58
		fz	0.009	0.009	0.009	0.008	0.007	0.007	0.006	0.006	0.011	0.009	0.009	0.008	0.008	0.007	0.012	0.012	0.012	0.011	0.011	0.011	0.011	0.011	0.011	0.011
		RPM	23343	23343	23343	20690	15385	15385	7958	7958	25920	23191	23191	20463	20463	15461	25863	25863	25863	23077	23077	23077	23077	23077	23077	23077
FEED		420	420	420	331	215	215	95	95	570	417	417	327	327	216	621	621	621	508	508	508	508	508	508	508	
10-11.1	Vc	46	46	46	41	31	31	15	15	60	54	54	48	48	36	69	69	69	62	62	62	62	62	62	62	
	fz	0.013	0.013	0.013	0.011	0.01	0.01	0.009	0.009	0.014	0.013	0.013	0.011	0.011	0.01	0.014	0.014	0.014	0.013	0.013	0.013	0.013	0.013	0.013	0.013	
	RPM	24404	24404	24404	21751	16446	16446	7958	7958	27284	24555	24555	21827	21827	16370	27454	27454	27454	24669	24669	24669	24669	24669	24669	24669	
	FEED	634	634	634	479	329	329	143	143	764	638	638	480	480	327	769	769	769	641	641	641	641	641	641	641	
11.2	Vc	44	44	44	39	29	29	15	15	57	51	51	45	45	34	65	65	65	58	58	58	58	58	58	58	
	fz	0.009	0.009	0.009	0.008	0.007	0.007	0.006	0.006	0.011	0.009	0.009	0.008	0.008	0.007	0.012	0.012	0.012	0.011	0.011	0.011	0.011	0.011	0.011	0.011	
	RPM	23343	23343	23343	20690	15385	15385	7958	7958	25920	23191	23191	20463	20463	15461	25863	25863	25863	23077	23077	23077	23077	23077	23077	23077	
	FEED	420	420	420	331	215	215	95	95	570	417	417	327	327	216	621	621	621	508	508	508	508	508	508	508	
K 15-20	Vc	46	46	46	41	31	31	15	15	60	54	54	48	48	36	69	69	69	62	62	62	62	62	62	62	
	fz	0.013	0.013	0.013	0.011	0.01	0.01	0.009	0.009	0.014	0.013	0.013	0.011	0.011	0.01	0.014	0.014	0.014	0.013	0.013	0.013	0.013	0.013	0.013	0.013	
	RPM	24404	24404	24404	21751	16446	16446	7958	7958	27284	24555	24555	21827	21827	16370	27454	27454	27454	24669	24669	24669	24669	24669	24669	24669	
	FEED	634	634	634	479	329	329	143	143	764	638	638	480	480	327	769	769	769	641	641	641	641	641	641	641	
H	38.1 - 38.2	Vc	39	39	39	34	26	26	13	13	50	45	45	40	40	30	57	57	57	52	52	52	52	52	52	
		fz	0.008	0.008	0.008	0.007	0.006	0.006	0.005	0.005	0.009	0.008	0.008	0.007	0.007	0.006	0.01	0.01	0.01	0.009	0.009	0.009	0.009	0.009	0.009	
		RPM	20690	20690	20690	18038	13793	13793	6897	6897	22736	20463	20463	18189	18189	13642	22680	22680	22680	20690	20690	20690	20690	20690	20690	20690
		FEED	331	331	331	253	166	166	69	69	409	327	327	255	255	164	454	454	454	372	372	372	372	372	372	372
	40	Vc	44	44	44	39	29	29	15	15	57	51	51	45	45	34	65	65	65	58	58	58	58	58	58	58
		fz	0.009	0.009	0.009	0.008	0.007	0.007	0.006	0.006	0.011	0.009	0.009	0.008	0.008	0.007	0.012	0.012	0.012	0.011	0.011	0.011	0.011	0.011	0.011	0.011
		RPM	23343	23343	23343	20690	15385	15385	7958	7958	25920	23191	23191	20463	20463	15461	25863	25863	25863	23077	23077	23077	23077	23077	23077	23077
		FEED	420	420	420	331	215	215	95	95	570	417	417	327	327	216	621	621	621	508	508	508	508	508	508	508
	41	Vc	39	39	39	34	26	26	13	13	50	45	45	40	40	30	57	57	57	52	52	52	52	52	52	52
		fz	0.008	0.008	0.008	0.007	0.006	0.006	0.005	0.005	0.009	0.008	0.008	0.007	0.007	0.006	0.01	0.01	0.01	0.009	0.009	0.009	0.009	0.009	0.009	0.009
		RPM	20690	20690	20690	18038	13793	13793	6897	6897	22736	20463	20463	18189	18189	13642	22680	22680	22680	20690	20690	20690	20690	20690	20690	20690
		FEED	331	331	331	253	166	166	69	69	409	327	327	255	255	164	454	454	454	372	372	372	372	372	372	372

▶ NEXT PAGE

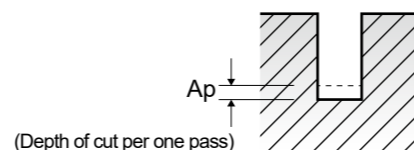

YG 4G MILL END MILLS

RECOMMENDED CUTTING CONDITIONS EMPFOHLENE SCHNEIDPARAMETER

SEM845 SERIES 2 FLUTE - SLOTTING

Vc = m/min. fz = mm/tooth
RPM = rev./min. FEED = mm/min.
Ap = mm LBS = Length Below Shank

VDI 3323	Parameter	Diameter (Ø)																																																																			
		0.8		0.8		0.8		0.8		0.8		0.9		0.9		0.9		1.0		1.0		1.0		1.0		1.0		1.0		1.0		1.0		1.0																																			
		LBS	8	10	12	14	16	20	6	8	10	2	3	4	5	6	7	8	10	12	14	16	18	20	22	8	10	12	14	16	18	20	22																																				
1-5	Vc	62	55	55	41	41	21	63	63	56	77	77	77	77	70	70	70	70	62	62	46	46	46	23	62	55	55	41	41	21	63	63	56	77	77	77	77	70	70	70	70	62	62	46	46	46	23																						
	fz	0.013	0.011	0.011	0.01	0.01	0.01	0.009	0.013	0.013	0.012	0.021	0.021	0.021	0.021	0.019	0.019	0.019	0.019	0.017	0.017	0.015	0.015	0.015	0.013	0.013	0.011	0.011	0.01	0.01	0.009	0.013	0.013	0.012	0.021	0.021	0.021	0.021	0.019	0.019	0.019	0.019	0.017	0.017	0.015	0.015	0.015	0.013																					
	RPM	24669	21884	21884	16313	16313	8356	22282	22282	19806	24510	24510	24510	24510	22282	22282	22282	22282	19806	24510	24510	24510	24510	22282	22282	22282	22282	19735	19735	14642	14642	14642	14642	14642	14642	14642	14642	14642	14642	14642	14642	14642	14642	14642	14642	14642	14642	14642	14642	14642	14642																		
	FEED	641	481	481	326	326	150	579	579	475	1029	1029	1029	1029	847	847	847	847	671	671	439	439	439	190	641	481	481	326	326	150	579	579	475	1029	1029	1029	1029	847	847	847	847	671	671	439	439	439	190	641	481	481	326	326	150	579	579	475	1029	1029	1029	1029	847	847	847	847	671	671	439	439	439
Ap	0.018	0.018	0.011	0.007	0.007	0.007	0.032	0.02	0.02	0.09	0.09	0.063	0.063	0.036	0.036	0.036	0.023	0.023	0.014	0.014	0.009	0.009	0.009	0.009	0.018	0.018	0.011	0.007	0.007	0.007	0.032	0.02	0.02	0.09	0.09	0.063	0.063	0.036	0.036	0.036	0.023	0.023	0.014	0.014	0.009	0.009	0.009	0.009	0.018	0.018	0.011	0.007	0.0																

SEM845 SERIES 2 FLUTE - SLOTTING

Vc = m/min. fz = mm/tooth
RPM = rev./min. FEED = mm/min.
Ap = mm LBS = Length Below Shank

Table with columns: ISO, VDI 3323, Parameter, Diameter (Ø) (3.0 to 4.5), and rows for Vc, fz, RPM, FEED, Ap for various ISO grades (P, K, H).

SEM845 SERIES 2 FLUTE - SLOTTING

Vc = m/min. fz = mm/tooth
RPM = rev./min. FEED = mm/min.
Ap = mm LBS = Length Below Shank

Table with columns: VDI 3323, Parameter, Diameter (Ø) (4.0 to 12.0), and rows for Vc, fz, RPM, FEED, Ap for various ISO grades (P, K, H).

▶ NEXT PAGE

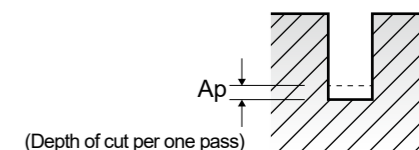
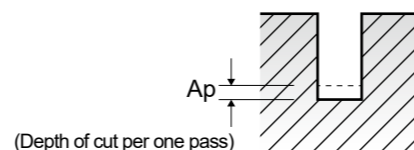



RECOMMENDED CUTTING CONDITIONS
EMPFOHLENE SCHNEIDPARAMETER

SEME36, SEME71 SERIES 4 FLUTE - SIDE CUTTING

Vc = m/min.
fz = mm/tooth
RPM = rev./min.
FEED = mm/min.

Table with columns: ISO, VDI 3323, Material Description, Ae, Ap, Parameter, Diameter (Ø) [0.8, 0.9, 1.0, 1.2, 1.5, 2.0, 2.5, 3.0], Vc, fz, RPM, FEED. Rows include materials like Non-alloy steel, Low alloy steel, High alloyed steel, Stainless steel, and Hardened steel.

▶ NEXT PAGE

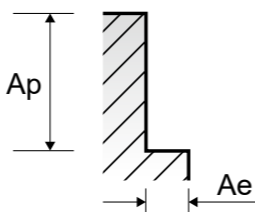

RECOMMENDED CUTTING CONDITIONS
EMPFOHLENE SCHNEIDPARAMETER

SEME36, SEME71 SERIES 4 FLUTE - SIDE CUTTING

Vc = m/min.
fz = mm/tooth
RPM = rev./min.
FEED = mm/min.

Table with columns: VDI 3323, Parameter, Diameter (Ø) [3.5, 4.0, 4.5, 5.0, 5.5, 6.0, 6.5, 7.0, 7.5, 8.0, 8.5, 9.0], Vc, fz, RPM, FEED. Rows include materials like Non-alloy steel, Low alloy steel, High alloyed steel, Stainless steel, and Hardened steel.

▶ NEXT PAGE

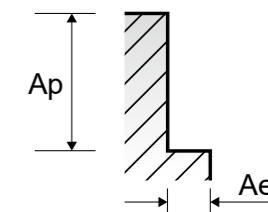

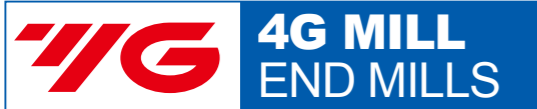

RECOMMENDED CUTTING CONDITIONS
EMPFOHLENE SCHNEIDPARAMETER

SEME36, SEME71 SERIES 4 FLUTE - SIDE CUTTING

Vc = m/min.
fz = mm/tooth
RPM = rev./min.
FEED = mm/min.

ISO	VDI 3323	Ae	Ap	Parameter	Diameter (Ø)							
					9.5	10.0	10.5	11.0	11.5	12.0	13.0	14.0
P	1-5	0.05D	1.0D	Vc	130	128	129	130	130	129	133	136
				fz	0.038	0.039	0.04	0.04	0.04	0.04	0.04	0.04
				RPM	4356	4074	3911	3762	3598	3422	3257	3092
	6-8	0.05D	1.0D	Vc	130	128	129	130	130	129	133	136
				fz	0.038	0.039	0.04	0.04	0.04	0.04	0.04	0.04
				RPM	4356	4074	3911	3762	3598	3422	3257	3092
	9	0.05D	1.0D	Vc	79	79	79	79	79	79	82	84
				fz	0.031	0.032	0.032	0.032	0.032	0.032	0.031	0.031
				RPM	2647	2515	2395	2286	2187	2096	2008	1910
	10-11.1	0.05D	1.0D	Vc	130	128	129	130	130	129	133	136
				fz	0.038	0.039	0.04	0.04	0.04	0.04	0.04	0.04
				RPM	4356	4074	3911	3762	3598	3422	3257	3092
11.2	0.05D	1.0D	Vc	79	79	79	79	79	79	82	84	
			fz	0.031	0.032	0.032	0.032	0.032	0.032	0.031	0.031	
			RPM	2647	2515	2395	2286	2187	2096	2008	1910	
M	14.1	0.05D	1.0D	Vc	67	66	66	66	65	64	66	68
				fz	0.037	0.038	0.038	0.038	0.038	0.037	0.037	0.037
				RPM	2245	2101	2001	1910	1799	1698	1616	1546
K	15-20	0.05D	1.0D	Vc	130	128	129	130	130	129	133	136
				fz	0.038	0.039	0.04	0.04	0.04	0.04	0.04	0.04
				RPM	4356	4074	3911	3762	3598	3422	3257	3092
H	38.1 - 38.2	0.05D	1.0D	Vc	54	53	54	55	55	55	56	57
				fz	0.014	0.014	0.014	0.014	0.015	0.015	0.015	0.015
				RPM	1809	1687	1637	1592	1522	1459	1371	1296
	40	0.05D	1.0D	Vc	79	79	79	79	79	79	82	84
				fz	0.031	0.032	0.032	0.032	0.032	0.032	0.031	0.031
				RPM	2647	2515	2395	2286	2187	2096	2008	1910
	41	0.05D	1.0D	Vc	54	53	54	55	55	55	56	57
				fz	0.014	0.014	0.014	0.014	0.015	0.015	0.015	0.015
				RPM	1809	1687	1637	1592	1522	1459	1371	1296

▶ NEXT PAGE

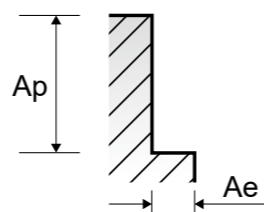

RECOMMENDED CUTTING CONDITIONS
EMPFOHLENE SCHNEIDPARAMETER

SEME36, SEME71 SERIES 4 FLUTE - SIDE CUTTING

Vc = m/min.
fz = mm/tooth
RPM = rev./min.
FEED = mm/min.

VDI 3323	Parameter	Diameter (Ø)											
		15.0	16.0	17.0	18.0	19.0	20.0	21.0	22.0	23.0	24.0	25.0	
1-5	Vc	138	138	138	137	135	132	133	134	134	134	134	
	fz	0.039	0.04	0.04	0.04	0.04	0.04	0.04	0.04	0.04	0.039	0.039	
	RPM	2928	2745	2584	2423	2262	2101	2016	1939	1855	1777	1706	
6-8	Vc	138	138	138	137	135	132	133	134	134	134	134	
	fz	0.039	0.04	0.04	0.04	0.04	0.04	0.04	0.04	0.04	0.039	0.039	
	RPM	2928	2745	2584	2423	2262	2101	2016	1939	1855	1777	1706	
9	Vc	85	85	86	85	85	84	84	84	84	84	82	
	fz	0.031	0.032	0.031	0.031	0.032	0.032	0.032	0.033	0.033	0.031	0.032	
	RPM	1804	1691	1610	1503	1424	1337	1273	1215	1163	1114	1044	
10 - 11.1	Vc	138	138	138	137	135	132	133	134	134	134	134	
	fz	0.039	0.04	0.04	0.04	0.04	0.04	0.04	0.04	0.04	0.039	0.039	
	RPM	2928	2745	2584	2423	2262	2101	2016	1939	1855	1777	1706	
11.2	Vc	85	85	86	85	85	84	84	84	84	84	82	
	fz	0.031	0.032	0.031	0.031	0.032	0.032	0.032	0.033	0.033	0.031	0.032	
	RPM	1804	1691	1610	1503	1424	1337	1273	1215	1163	1114	1044	
14.1	Vc	69	69	69	68	67	66	67	67	67	67	67	
	fz	0.038	0.038	0.039	0.038	0.039	0.038	0.037	0.037	0.038	0.037	0.037	
	RPM	1464	1373	1292	1203	1122	1050	1016	969	927	889	853	
15 - 20	Vc	138	138	138	137	135	132	133	134	134	134	134	
	fz	0.039	0.04	0.04	0.04	0.04	0.04	0.04	0.04	0.04	0.039	0.039	
	RPM	2928	2745	2584	2423	2262	2101	2016	1939	1855	1777	1706	
38.1 - 38.2	Vc	57	57	57	56	55	53	54	54	54	54	53	
	fz	0.014	0.014	0.014	0.014	0.013	0.012	0.013	0.013	0.013	0.012	0.011	
	RPM	1210	1134	1067	990	921	844	819	781	747	716	675	
40	Vc	85	85	86	85	85	84	84	84	84	84	82	
	fz	0.031	0.032	0.031	0.031	0.032	0.032	0.032	0.033	0.033	0.031	0.032	
	RPM	1804	1691	1610	1503	1424	1337	1273	1215	1163	1114	1044	
41	Vc	57	57	57	56	55	53	54	54	54	54	53	
	fz	0.014	0.014	0.014	0.014	0.013	0.012	0.013	0.013	0.013	0.012	0.011	
	RPM	1210	1134	1067	990	921	844	819	781	747	716	675	

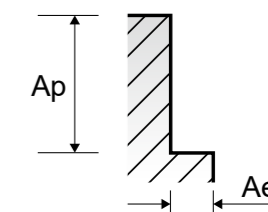

SEME72 SERIES 4 FLUTE - SIDE CUTTING

Vc = m/min. fz = mm/tooth
RPM = rev./min. FEED = mm/min.
LOC = Length of Cut

Table with columns: ISO, VDI 3323, Material Description, Ae, Ap, Parameter (LOC), Diameter (Ø) (1.0 to 1.2), and cutting parameters (Vc, fz, RPM, FEED) for various materials like Non-alloy steel, Low alloy steel, High alloyed steel, Grey cast iron, Hardened steel, and Chilled Cast Iron.

▶ NEXT PAGE

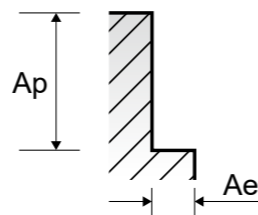

SEME72 SERIES 4 FLUTE - SIDE CUTTING

Vc = m/min. fz = mm/tooth
RPM = rev./min. FEED = mm/min.
LOC = Length of Cut

Table with columns: VDI 3323, Parameter (LOC), Diameter (Ø) (1.2 to 3.0), and cutting parameters (Vc, fz, RPM, FEED) for various materials like Non-alloy steel, Low alloy steel, High alloyed steel, Grey cast iron, Hardened steel, and Chilled Cast Iron.

▶ NEXT PAGE

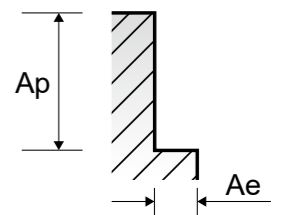



RECOMMENDED CUTTING CONDITIONS
EMPFOHLENE SCHNEIDPARAMETER

SEME72 SERIES 4 FLUTE - SIDE CUTTING

Vc = m/min. fz = mm/tooth
RPM = rev./min. FEED = mm/min.
LOC = Length of Cut

Table with columns for ISO, VDI 3323, Ae, Ap, Parameter, and Diameter (Ø) with sub-columns for LOC and various diameter values (3.0 to 5.0). Rows include ISO P (1-5, 6-8, 9, 10-11.1, 11.2) and ISO K (15-20) and ISO H (38.1-38.2, 40, 41).

▶ NEXT PAGE

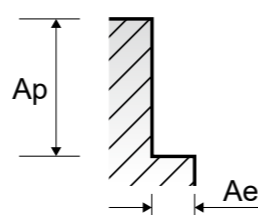

RECOMMENDED CUTTING CONDITIONS
EMPFOHLENE SCHNEIDPARAMETER

SEME72 SERIES 4 FLUTE - SIDE CUTTING

Vc = m/min. fz = mm/tooth
RPM = rev./min. FEED = mm/min.
LOC = Length of Cut

Table with columns for VDI 3323, Parameter, and Diameter (Ø) with sub-columns for LOC and various diameter values (6.0 to 10.0). Rows include VDI 1-5, 6-8, 9, 10-11.1, 11.2, 15-20, 38.1-38.2, 40, and 41.

▶ NEXT PAGE

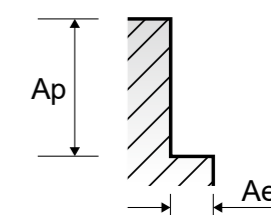



RECOMMENDED CUTTING CONDITIONS
EMPFOHLENE SCHNEIDPARAMETER

SEME72 SERIES 4 FLUTE - SIDE CUTTING

Vc = m/min. fz = mm/tooth
RPM = rev./min. FEED = mm/min.
LOC = Length of Cut

Table with columns for ISO, VDI 3323, Ae, Ap, Parameter, and Diameter (Ø) ranging from 10.0 to 16.0. Rows include material groups P, K, and H with various ISO grades and their corresponding cutting parameters.

▶ NEXT PAGE

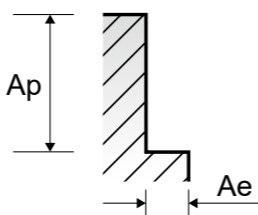

RECOMMENDED CUTTING CONDITIONS
EMPFOHLENE SCHNEIDPARAMETER

SEME72 SERIES 4 FLUTE - SIDE CUTTING

Vc = m/min. fz = mm/tooth
RPM = rev./min. FEED = mm/min.
LOC = Length of Cut

Table with columns for VDI 3323, Parameter, and Diameter (Ø) ranging from 16.0 to 25.0. Rows include material groups P, K, and H with various VDI grades and their corresponding cutting parameters.

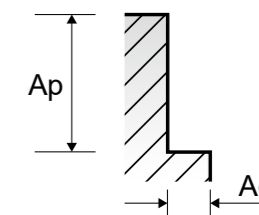

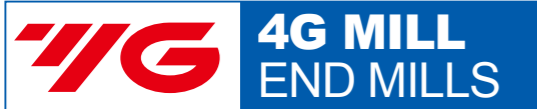

RECOMMENDED CUTTING CONDITIONS
EMPFOHLENE SCHNEIDPARAMETER

SEME73 SERIES 4 FLUTE - SIDE CUTTING

Vc = m/min. fz = mm/tooth
RPM = rev./min. FEED = mm/min.
Ae = mm LBS = Length Below Shank

Table with columns for ISO, VDI 3323, Parameter, Diameter (Ø), and various cutting parameters (Vc, fz, RPM, FEED, Ae) for different materials and diameters.

▶ NEXT PAGE

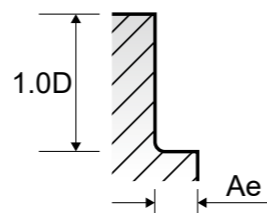

RECOMMENDED CUTTING CONDITIONS
EMPFOHLENE SCHNEIDPARAMETER

SEME73 SERIES 4 FLUTE - SIDE CUTTING

Vc = m/min. fz = mm/tooth
RPM = rev./min. FEED = mm/min.
Ae = mm LBS = Length Below Shank

Table with columns for VDI 3323, Parameter, Diameter (Ø), and various cutting parameters (Vc, fz, RPM, FEED, Ae) for different materials and diameters.

▶ NEXT PAGE

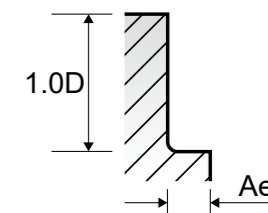



RECOMMENDED CUTTING CONDITIONS EMPFOHLENE SCHNEIDPARAMETER

SEME75 SERIES 6 FLUTE - SIDE CUTTING

NORMAL SPEED

Table with columns for ISO, VDI 3323, Material Description, Ae, Ap, Parameter, and Diameter (Ø) for various materials like Non-alloy steel, Low alloy steel, High alloyed steel, and Grey cast iron.

Vc = m/min. fz = mm/tooth
RPM = rev./min. FEED = mm/min.
LOC = Length of Cut

HIGH SPEED

Table with columns for ISO, VDI 3323, Material Description, Ae, Ap, Parameter, and Diameter (Ø) for High alloyed steel, Hardened steel, and Chilled Cast Iron.

▶ NEXT PAGE

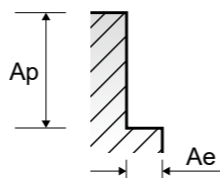

RECOMMENDED CUTTING CONDITIONS EMPFOHLENE SCHNEIDPARAMETER

SEME75 SERIES 6 FLUTE - SIDE CUTTING

NORMAL SPEED

Table with columns for VDI 3323, Parameter, and Diameter (Ø) for various materials like Non-alloy steel, Low alloy steel, High alloyed steel, and Grey cast iron.

Vc = m/min. fz = mm/tooth
RPM = rev./min. FEED = mm/min.
LOC = Length of Cut

HIGH SPEED

Table with columns for VDI 3323, Parameter, and Diameter (Ø) for High alloyed steel, Hardened steel, and Chilled Cast Iron.

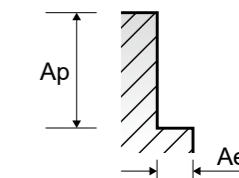

G9D75 G9D67 **G9D76 G9D68** **G9D77 G9D69**

4&5 FLUTE CORNER RADIUS ROUGHING

Vc = m/min.
fz = mm/tooth
RPM = rev./min.
FEED = mm/min.

SLOTTING

ISO	VDI 3323	Material Description	Ae	Ap	Parameter	Diameter (Ø)					
						6.0	8.0	10.0	12.0	16.0	20.0
P	1-3	Non-alloy steel	1.0D	1.0D	Vc	225	225	225	225	225	225
					fz	0.032	0.046	0.057	0.064	0.067	0.074
	RPM				11937	8952	7162	5968	4476	3581	
	FEED				1528	1647	1633	1528	1500	1325	
	Vc				200	205	200	205	205	200	
	fz				0.026	0.036	0.046	0.053	0.051	0.056	
	4-5	Low alloy steel	1.0D	0.8D	Vc	225	225	225	225	225	225
					fz	0.032	0.046	0.057	0.064	0.067	0.074
	RPM				11937	8952	7162	5968	4476	3581	
	FEED				1528	1647	1633	1528	1500	1325	
	Vc				200	205	200	205	205	200	
	fz				0.026	0.036	0.046	0.053	0.051	0.056	
6	High alloyed steel, and tool steel	1.0D	1.0D	Vc	225	225	225	225	225	225	
				fz	0.032	0.046	0.057	0.064	0.067	0.074	
RPM				11937	8952	7162	5968	4476	3581		
FEED				1528	1647	1633	1528	1500	1325		
Vc				200	205	200	205	205	200		
fz				0.026	0.036	0.046	0.053	0.051	0.056		
7-9	High alloyed steel, and tool steel	1.0D	0.8D	Vc	225	225	225	225	225	225	
				fz	0.032	0.046	0.057	0.064	0.067	0.074	
RPM				11937	8952	7162	5968	4476	3581		
FEED				1528	1647	1633	1528	1500	1325		
Vc				200	205	200	205	205	200		
fz				0.026	0.036	0.046	0.053	0.051	0.056		
10	High alloyed steel, and tool steel	1.0D	1.0D	Vc	225	225	225	225	225	225	
				fz	0.032	0.046	0.057	0.064	0.067	0.074	
RPM				11937	8952	7162	5968	4476	3581		
FEED				1528	1647	1633	1528	1500	1325		
Vc				200	205	200	205	205	200		
fz				0.026	0.036	0.046	0.053	0.051	0.056		
11.1	High alloyed steel, and tool steel	1.0D	0.8D	Vc	225	225	225	225	225	225	
				fz	0.032	0.046	0.057	0.064	0.067	0.074	
RPM				11937	8952	7162	5968	4476	3581		
FEED				1528	1647	1633	1528	1500	1325		
Vc				200	205	200	205	205	200		
fz				0.026	0.036	0.046	0.053	0.051	0.056		
K	15-20	Grey cast iron Nodular cast iron Malleable cast iron	1.0D	1.0D	Vc	225	225	225	225	225	225
					fz	0.032	0.046	0.057	0.064	0.067	0.074
					RPM	11937	8952	7162	5968	4476	3581
					FEED	1528	1647	1633	1528	1500	1325

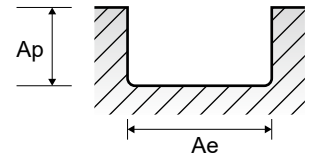

SIDE CUTTING

ISO	VDI 3323	Material Description	Ae	Ap	Parameter	Diameter (Ø)					
						6.0	8.0	10.0	12.0	16.0	20.0
P	1-3	Non-alloy steel	0.5D	1.0D	Vc	300	300	300	300	300	300
					fz	0.041	0.057	0.071	0.08	0.082	0.089
	RPM				15915	11937	9549	7958	5968	4775	
	FEED				2610	2722	2712	2546	2447	2125	
	Vc				270	270	265	270	270	270	
	fz				0.032	0.046	0.057	0.065	0.065	0.07	
	4-5	Low alloy steel	0.35D	1.0D	Vc	300	300	300	300	300	300
					fz	0.041	0.057	0.071	0.08	0.082	0.089
	RPM				15915	11937	9549	7958	5968	4775	
	FEED				2610	2722	2712	2546	2447	2125	
	Vc				270	270	265	270	270	270	
	fz				0.032	0.046	0.057	0.065	0.065	0.07	
6	High alloyed steel, and tool steel	0.5D	1.0D	Vc	300	300	300	300	300	300	
				fz	0.041	0.057	0.071	0.08	0.082	0.089	
RPM				15915	11937	9549	7958	5968	4775		
FEED				2610	2722	2712	2546	2447	2125		
Vc				270	270	265	270	270	270		
fz				0.032	0.046	0.057	0.065	0.065	0.07		
7-9	High alloyed steel, and tool steel	0.35D	1.0D	Vc	300	300	300	300	300	300	
				fz	0.041	0.057	0.071	0.08	0.082	0.089	
RPM				15915	11937	9549	7958	5968	4775		
FEED				2610	2722	2712	2546	2447	2125		
Vc				270	270	265	270	270	270		
fz				0.032	0.046	0.057	0.065	0.065	0.07		
10	High alloyed steel, and tool steel	0.5D	1.0D	Vc	300	300	300	300	300	300	
				fz	0.041	0.057	0.071	0.08	0.082	0.089	
RPM				15915	11937	9549	7958	5968	4775		
FEED				2610	2722	2712	2546	2447	2125		
Vc				270	270	265	270	270	270		
fz				0.032	0.046	0.057	0.065	0.065	0.07		
11.1	High alloyed steel, and tool steel	0.35D	1.0D	Vc	300	300	300	300	300	300	
				fz	0.041	0.057	0.071	0.08	0.082	0.089	
RPM				15915	11937	9549	7958	5968	4775		
FEED				2610	2722	2712	2546	2447	2125		
Vc				270	270	265	270	270	270		
fz				0.032	0.046	0.057	0.065	0.065	0.07		
K	15-20	Grey cast iron Nodular cast iron Malleable cast iron	0.5D	1.0D	Vc	300	300	300	300	300	300
					fz	0.041	0.057	0.071	0.08	0.082	0.089
					RPM	15915	11937	9549	7958	5968	4775
					FEED	2610	2722	2712	2546	2447	2125

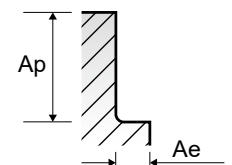



Leading Through Innovation



SOLID CARBIDE

X-POWER PRO END MILLS

X-POWER PRO VHM - FRÄSER

- For Pre-Hardened Steels up to HRc55
- Für vorgehärtete Stähle bis HRc55

CARBIDE, 2 FLUTE SHORT LENGTH BALL NOSE

- VOLLHARTMETALL, 2 SCHNEIDEN KURZ KUGELSTIRN
- ① Fraise carbure, 2 dents, hémisphérique, courte
- ② TAGLIENTI, SEMISFERICA, SERIE CORTA

- ▶ Economic type with short overall length.
- ▶ Radius tolerance ±0.02mm & short length of cut.

- ▶ Günstige Variante, kurze Gesamlänge.
- ▶ Radius Toleranz ±0.02mm und kurze Schneidenlänge.

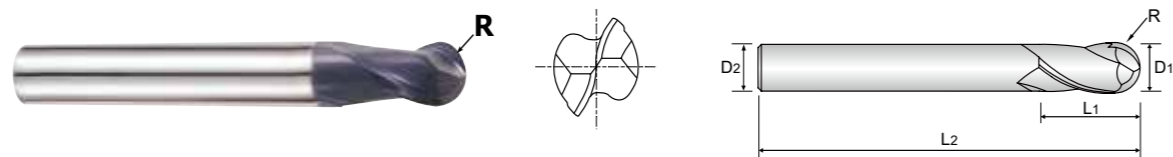

Plain Shank	Page
HYDRAULIC CHUCK	D15-46
SHRINK FIT HOLDER	D47-72
POWER MILLING CHUCK	D161-176
ER COLLET CHUCK	D73-116
SK SLIM CHUCK	D183-201

Unit : mm

EDP No.	Radius of Ball Nose	Mill Diameter	Shank Diameter	Length of Cut	Overall Length
	R(±0.02)	D1	D2	L1	L2
GM876010	R0.5	1.0	3	3	38
GM876020	R1.0	2.0	6	3	50
GM876030	R1.5	3.0	6	4	50
GM876040	R2.0	4.0	6	5	54
GM876060	R3.0	6.0	6	7	54
GM876080	R4.0	8.0	8	9	58
GM876100	R5.0	10.0	10	11	66
GM876120	R6.0	12.0	12	12	73
GM876160	R8.0	16.0	16	16	82

Mill Dia. Tolerance (mm)	Shank Dia. Tolerance
0 ~ -0.03	h5

◎ : Excellent ○ : Good

ISO Material Description	P									M				K						
	Non-alloy steel			Low alloy steel			High alloyed steel, and tool steel			Stainless steel		Grey cast iron	Nodular cast iron		Malleable cast iron					
VDI 3323	1	2	3	4	5	6	7	8	9	10	11	12	13	14	15	16	17	18	19	20
HRc	13	25	28	32	38	42	48	52	58	62	68	72	78	82	88	92	98	102	108	112
HB	125	190	250	270	300	180	275	300	350	200	325	200	240	180	180	260	160	250	130	230
Recommend	○	○	○	◎	◎	○	◎	◎	◎	◎	◎	○	○	○	○	○	○	○	○	○

ISO Material Description	N						S				H										
	Aluminum-wrought alloy		Aluminum-cast, alloyed		Copper and Copper Alloys (Bronze / Brass)		Non Metallic Materials		Heat Resistant Super Alloys		Titanium Alloys		Hardened steel	Chilled Cast Iron	Hardened Cast Iron						
VDI 3323	21	22	23	24	25	26	27	28	29	30	31	32	33	34	35	36	37	38	39	40	41
HRc	21	22	23	24	25	26	27	28	29	30	31	32	33	34	35	36	37	38	39	40	41
HB	60	100	75	90	130	110	90	100			200	280	250	350	320	400 Rm	1050 Rm	550	630	400	550
Recommend	○	○	○	○	○	○	○	○	○	○	○	○	○	○	○	○	○	○	○	○	○

CARBIDE, 2 FLUTE LONG LENGTH BALL NOSE

- VOLLHARTMETALL, 2 SCHNEIDEN LANG KUGELSTIRN
- ① Fraise carbure, 2 dents, hémisphérique, longue
- ② TAGLIENTI, SEMISFERICA, SERIE LUNGA

- ▶ Designed to machine tool steel, alloy steel, mold steel and other high hardened materials.
- ▶ For copy - milling machines.

- ▶ Zur Bearbeitung von Werkzeugstählen, Legierten Stählen, Stahlguß und gehärteten Stählen.
- ▶ Für Kopierfräsmaschinen.

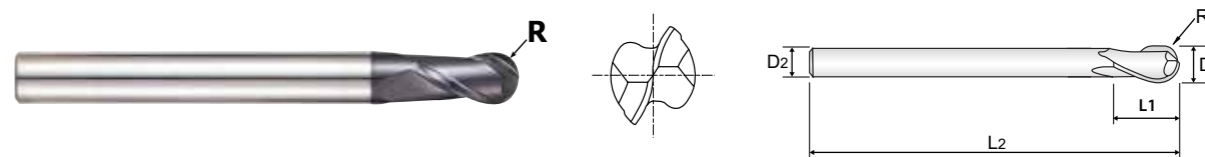

Plain Shank	Page
HYDRAULIC CHUCK	D15-46
SHRINK FIT HOLDER	D47-72
POWER MILLING CHUCK	D161-176
ER COLLET CHUCK	D73-116
SK SLIM CHUCK	D183-201

Unit : mm

EDP No.	Radius of Ball Nose	Mill Diameter	Shank Diameter	Length of Cut	Overall Length
	R(±0.02)	D1	D2	L1	L2
GM813010	R0.5	1.0	4	2.5	50
GM813020	R1.0	2.0	6	5	50
GM813030	R1.5	3.0	6	8	60
GM813040	R2.0	4.0	6	8	70
GM813050	R2.5	5.0	6	10	80
GM813060	R3.0	6.0	6	12	90
GM813080	R4.0	8.0	8	14	100
GM813100	R5.0	10.0	10	18	100
GM813120	R6.0	12.0	12	22	110
GM813160	R8.0	16.0	16	30	140
GM813200	R10.0	20.0	20	38	160

Mill Dia. Tolerance (mm)	Shank Dia. Tolerance
0 ~ -0.03	h5

◎ : Excellent ○ : Good

ISO Material Description	P									M				K						
	Non-alloy steel			Low alloy steel			High alloyed steel, and tool steel			Stainless steel		Grey cast iron	Nodular cast iron		Malleable cast iron					
VDI 3323	1	2	3	4	5	6	7	8	9	10	11	12	13	14	15	16	17	18	19	20
HRc	13	25	28	32	38	42	48	52	58	62	68	72	78	82	88	92	98	102	108	112
HB	125	190	250	270	300	180	275	300	350	200	325	200	240	180	180	260	160	250	130	230
Recommend	○	○	○	◎	◎	○	◎	◎	◎	◎	◎	○	○	○	○	○	○	○	○	○

ISO Material Description	N						S				H										
	Aluminum-wrought alloy		Aluminum-cast, alloyed		Copper and Copper Alloys (Bronze / Brass)		Non Metallic Materials		Heat Resistant Super Alloys		Titanium Alloys		Hardened steel	Chilled Cast Iron	Hardened Cast Iron						
VDI 3323	21	22	23	24	25	26	27	28	29	30	31	32	33	34	35	36	37	38	39	40	41
HRc	21	22	23	24	25	26	27	28	29	30	31	32	33	34	35	36	37	38	39	40	41
HB	60	100	75	90	130	110	90	100			200	280	250	350	320	400 Rm	1050 Rm	550	630	400	550
Recommend	○	○	○	○	○	○	○	○	○	○	○	○	○	○	○	○	○	○	○	○	○

CARBIDE, 2 FLUTE BALL NOSE with TAPER NECK

- VOLLHARTMETALL, 2 SCHNEIDEN KUGELSTIRN mit KONISCH ABGESETZTEM SCHAFTTEIL
- Ⓢ Fraise carbure, 2 dents, hémisphérique avec entrée conique
- Ⓢ 2 TAGLIENTI, SEMISFERICA, SCARICO CONICO

► High efficiency milling in deep slotting due to long projection of the end mills. ► Effizientes Tiefnutenfräsen von tiefliegenden Bereichen möglich.

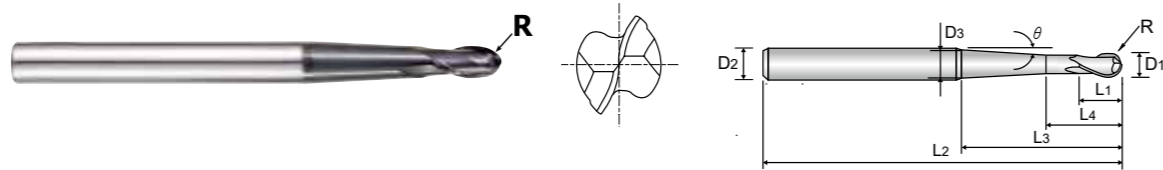

p.C358-359

Recommended ToolHolder	Plain Shank	Page
◎	HYDRAULIC CHUCK	D15-46
◎	SHRINK FIT HOLDER	D47-72
◎	POWER MILLING CHUCK	D161-176
◎	ER COLLET CHUCK	D73-116
○	SK SLIM CHUCK	D183-201

Unit : mm

EDP No.	Radius of Ball Nose R(±0.01)	Mill Diameter D1	Shank Diameter D2	Length of Cut L1	Under Neck Parallel Length L4	Length Below Shank L3	Overall Length L2	Neck Diameter D3	Taper Neck Angle θ
GM902010	R0.5	1.0	6	2	4	23	60	2	1° 30'
GM902901	R0.5	1.0	6	2	4	23	60	4.3	5°
GM902902	R0.5	1.0	6	2	4	42	80	5	3°
GM902020	R1.0	2.0	6	4	6	23	60	2.9	1° 30'
GM902903	R1.0	2.0	6	4	6	23	60	5	5°
GM902904	R1.0	2.0	6	4	6	41	80	5.7	3°
GM902030	R1.5	3.0	6	6	8	32	70	5.6	3°
GM902905	R1.5	3.0	6	6	8	52	90	5.3	1° 30'
GM902040	R2.0	4.0	6	8	10	28	70	5.9	3°
GM902906	R2.0	4.0	6	8	10	49	90	6	1° 30'
GM902060	R3.0	6.0	8	12	15	34	90	8	3°
GM902908	R3.0	6.0	8	12	15	53	110	8	1° 30'
GM902080	R4.0	8.0	10	14	17	36	100	10	3°
GM902909	R4.0	8.0	10	14	17	55	120	10	1° 30'

Mill Dia. Tolerance (mm)	Shank Dia. Tolerance
0 ~ -0.03	h5

ISO	P									M					K						
Material Description	Non-alloy steel			Low alloy steel			High alloyed steel, and tool steel			Stainless steel			Grey cast iron	Nodular cast iron		Malleable cast iron					
VDI 3323	1	2	3	4	5	6	7	8	9	10	11	12	13	14	15	16	17	18	19	20	
HRC		13	25	28	32	10	29	32	38	15	35	15	23	10	10	26	3	25	21		
HB	125	190	250	270	300	180	275	300	350	200	325	200	240	180	180	260	160	250	130	230	
Recommend	○	○	○	○	○	○	○	◎	◎	◎	◎	◎	◎	◎	◎	◎	◎	◎	◎	◎	
ISO	N									S						H					
Material Description	Aluminum-wrought alloy		Aluminum-cast, alloyed			Copper and Copper Alloys (Bronze / Brass)			Non Metallic Materials		Heat Resistant Super Alloys			Titanium Alloys			Hardened steel	Chilled Cast Iron	Hardened Cast Iron		
VDI 3323	21	22	23	24	25	26	27	28	29	30	31	32	33	34	35	36	37	38	39	40	41
HRC																					
HB	60	100	75	90	130	110	90	100			200	280	250	350	320	400 Rm	1050 Rm	550	630	400	550
Recommend																		◎	◎	◎	◎

◎ : Excellent ○ : Good

CARBIDE, 4 FLUTE LONG LENGTH BALL NOSE

- VOLLHARTMETALL, 4 SCHNEIDEN LANG KUGELSTIRN
- Ⓢ Fraise carbure, 4 dents, hémisphérique, longue
- Ⓢ 4 TAGLIENTI, SEMISFERICA, SERIE LUNGA

► Designed to machine tool steels, alloy steels, mold steels and other high hardened materials. ► Zur Bearbeitung von Werkzeugstählen, Legierten Stählen, Stahlguß und gehärteten Stählen.
 ► For copy - milling machines. ► Für Kopierfräsmaschinen.
 ► 4 Flute design - higher feed than GM813 series. ► 4 Schneiden - Höherer Vorschub als bei GM813 series.

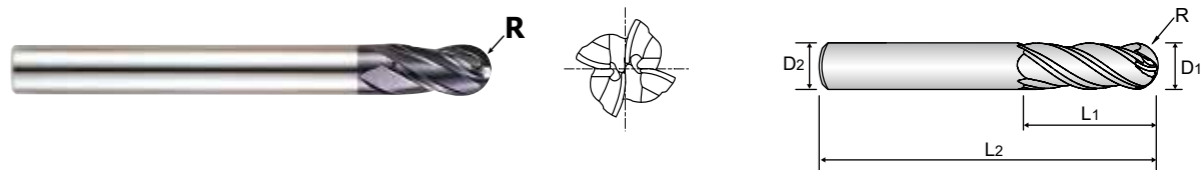

p.C360-361

Recommended ToolHolder	Plain Shank	Page
◎	HYDRAULIC CHUCK	D15-46
◎	SHRINK FIT HOLDER	D47-72
◎	POWER MILLING CHUCK	D161-176
◎	ER COLLET CHUCK	D73-116
○	SK SLIM CHUCK	D183-201

Unit : mm

EDP No.	Radius of Ball Nose R(±0.02)	Mill Diameter D1	Shank Diameter D2	Length of Cut L1	Overall Length L2
GM815020	R1.0	2.0	6	5	50
GM815030	R1.5	3.0	6	8	60
GM815040	R2.0	4.0	6	8	70
GM815050	R2.5	5.0	6	10	80
GM815060	R3.0	6.0	6	12	90
GM815080	R4.0	8.0	8	14	100
GM815100	R5.0	10.0	10	18	100
GM815120	R6.0	12.0	12	22	110
GM815160	R8.0	16.0	16	30	140

Mill Dia. Tolerance (mm)	Shank Dia. Tolerance
0 ~ -0.03	h5

ISO	P									M					K						
Material Description	Non-alloy steel			Low alloy steel			High alloyed steel, and tool steel			Stainless steel			Grey cast iron	Nodular cast iron		Malleable cast iron					
VDI 3323	1	2	3	4	5	6	7	8	9	10	11	12	13	14	15	16	17	18	19	20	
HRC		13	25	28	32	10	29	32	38	15	35	15	23	10	10	26	3	25	21		
HB	125	190	250	270	300	180	275	300	350	200	325	200	240	180	180	260	160	250	130	230	
Recommend	○	○	○	○	○	○	◎	◎	◎	◎	◎	◎	◎	◎	◎	◎	◎	◎	◎	◎	◎
ISO	N									S						H					
Material Description	Aluminum-wrought alloy		Aluminum-cast, alloyed			Copper and Copper Alloys (Bronze / Brass)			Non Metallic Materials		Heat Resistant Super Alloys			Titanium Alloys			Hardened steel	Chilled Cast Iron	Hardened Cast Iron		
VDI 3323	21	22	23	24	25	26	27	28	29	30	31	32	33	34	35	36	37	38	39	40	41
HRC																					
HB	60	100	75	90	130	110	90	100			200	280	250	350	320	400 Rm	1050 Rm	550	630	400	550
Recommend																		◎	◎	◎	◎

◎ : Excellent ○ : Good



CARBIDE, 2 FLUTE LONG LENGTH CORNER RADIUS

VOLLHARTMETALL, 2 SCHNEIDEN LANG ECKENRADIUS
Fraise carbure, 2 dents, torique, longue
2 TAGLIANTI, TORICA, SERIE LUNGA

- Designed to machine tool steels, alloy steels, mold steels and other hardened materials.
Superior workpiece finishes.
Increased feed rates.

- Zur Bearbeitung von Werkzeugstählen, Legierten Stählen, Stahlguß und gehärteten Stählen.
Bessere Werkstückoberflächen.
Höhere Vorschubwerte.

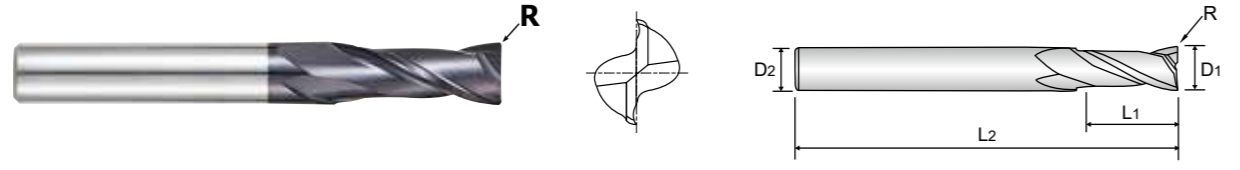

Table with Recommended ToolHolder, Plain Shank, and Page information.

Main product table for GM818 series listing EDP No., Corner Radius, Mill Diameter, Shank Diameter, Length of Cut, and Overall Length.

Table with Mill Dia. Tolerance (mm) and Shank Dia. Tolerance.

Material compatibility table with columns for Non-alloy steel, Low alloy steel, High alloyed steel, Stainless steel, Grey cast iron, Nodular cast iron, and Malleable cast iron.

Detailed material compatibility table including Aluminum-wrought alloy, Aluminum-cast, alloyed, Copper and Copper Alloys, Non Metallic Materials, Heat Resistant Super Alloys, and Titanium Alloys.



CARBIDE, 2 FLUTE CORNER RADIUS for RIB PROCESSING

VOLLHARTMETALL, 2 SCHNEIDEN ECKENRADIUS für SCHMALE RIPPEN
Fraise carbure, 2 dents, torique pour usinage de rainure
2 TAGLIANTI, TORICA PER NERVATURA

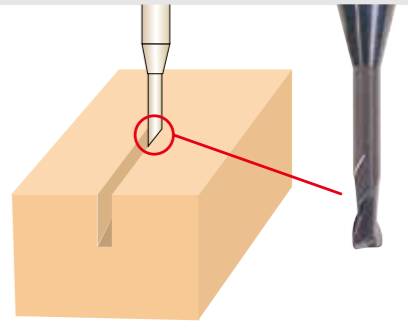
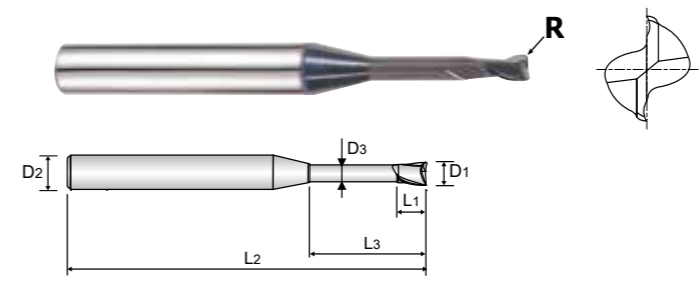

Table with Recommended ToolHolder, Plain Shank, and Page information.

Main product table for GM8A1 series listing EDP No., Corner Radius, Mill Diameter, Shank Diameter, Length of Cut, Length Below Shank, Overall Length, and Neck Diameter.

Table with Mill Dia. Tolerance (mm) and Shank Dia. Tolerance.

NEXT PAGE

Detailed material compatibility table including Aluminum-wrought alloy, Aluminum-cast, alloyed, Copper and Copper Alloys, Non Metallic Materials, Heat Resistant Super Alloys, and Titanium Alloys.

CARBIDE, 2 FLUTE CORNER RADIUS for RIB PROCESSING

- VOLLHARTMETALL, 2 SCHNEIDEN ECKENRADIUS für SCHMALE RIPPEN
- Fraise carbure, 2 dents, torique pour usinage de rainure
- 2 TAGLIENTI, TORICA PER NERVATURE

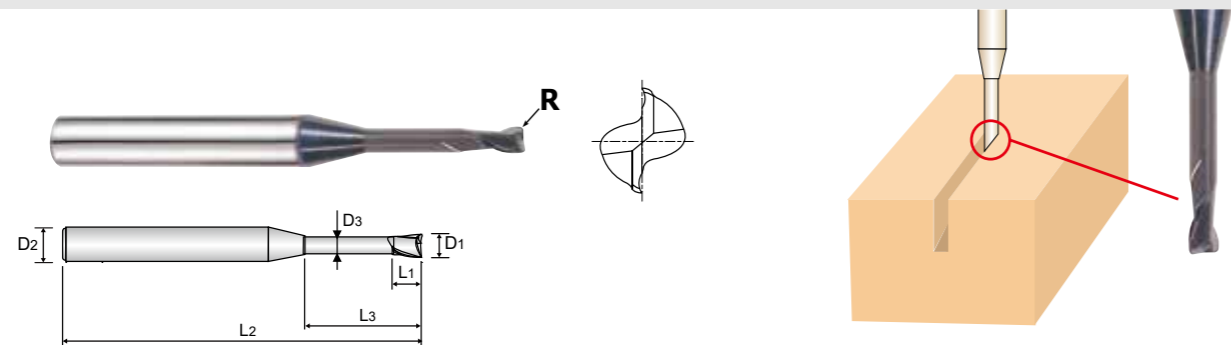

CARBIDE 2 30° PLAIN Coating Y p.C363-364

Recommended ToolHolder	Plain Shank	Page
◎	HYDRAULIC CHUCK	D15-46
◎	SHRINK FIT HOLDER	D47-72
◎	POWER MILLING CHUCK	D161-176
◎	ER COLLET CHUCK	D73-116
◎	SK SLIM CHUCK	D183-201

Unit : mm

EDP No.	Corner Radius	Mill Diameter	Shank Diameter	Length of Cut	Length Below Shank	Overall Length	Neck Diameter
	R	D1	D2	L1	L3	L2	D3
GM8A1981	R0.3	3.0	6	4.5	16	55	2.85
GM8A1983	R0.3	3.0	6	4.5	20	60	2.85
GM8A1984	R0.3	3.0	6	4.5	25	65	2.85
GM8A1976	R0.3	3.0	6	4.5	30	70	2.85
GM8A1985	R0.3	3.0	6	4.5	40	90	2.85
GM8A1040	R0.3	4.0	6	6	12	50	3.85
GM8A1986	R0.3	4.0	6	6	16	60	3.85
GM8A1987	R0.3	4.0	6	6	20	60	3.85
GM8A1060	R0.5	6.0	6	9	20	80	5.85
GM8A1802	R0.5	6.0	6	9	40	100	5.85

Mill Dia. Tolerance (mm)	Shank Dia. Tolerance
0 ~ -0.03	h5

◎ : Excellent ○ : Good

ISO Material Description	P									M					K					
	Non-alloy steel			Low alloy steel			High alloyed steel, and tool steel			Stainless steel			Grey cast iron		Nodular cast iron		Malleable cast iron			
VDI 3323	1	2	3	4	5	6	7	8	9	10	11	12	13	14	15	16	17	18	19	20
HRc	13	25	28	32	30	10	29	32	38	15	35	15	23	10	10	26	3	25	21	
HB	125	190	250	270	300	180	275	300	350	200	325	200	240	180	180	260	160	250	130	230
Recommend	○	○	○	◎	◎	○	◎	◎	◎	◎	◎	○	○	○	○	○	○	○	○	○

ISO Material Description	N					S					H										
	Aluminum-wrought alloy		Aluminum-cast, alloyed		Copper and Copper Alloys (Bronze / Brass)	Non Metallic Materials		Heat Resistant Super Alloys			Titanium Alloys		Hardened steel	Chilled Cast Iron	Hardened Cast Iron						
VDI 3323	21	22	23	24	25	26	27	28	29	30	31	32	33	34	35	36	37	38	39	40	41
HRc											15	30	25	38	34			55	60	42	55
HB	60	100	75	90	130	110	90	100			200	280	250	350	320	400 Rm	1050 Rm	550	630	400	550
Recommend																		○	◎	○	○

CARBIDE, 4 FLUTE STUB LENGTH CORNER RADIUS

- VOLLHARTMETALL, 4 SCHNEIDEN EXTRA KURZ ECKENRADIUS
- Fraise carbure, 4 dents, torique, extra-courte
- 4 TAGLIENTI, TORICA, TAGLIENTE CORTO, SCARICATA

- ▶ Designed to machine tool steels, alloy steels, mold steels and other hardened materials.
- ▶ Superior workpiece finishes.
- ▶ Increased feed rates.
- ▶ Zur Bearbeitung von Werkzeugstählen, Legierten Stählen, Stahlguß und gehärteten Stählen.
- ▶ Bessere Werkstückoberflächen.
- ▶ Höhere Vorschubwerte.

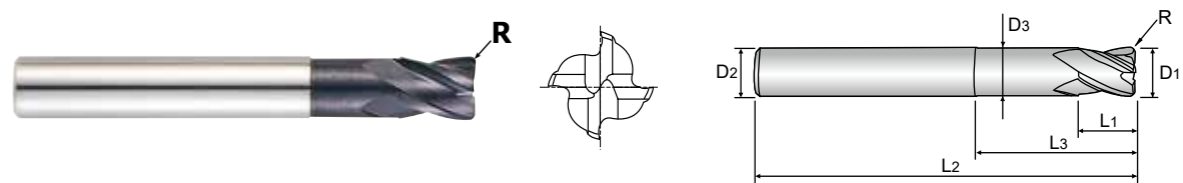

CARBIDE 4 30° PLAIN Coating Y p.C365

Recommended ToolHolder	Plain Shank	Page
◎	HYDRAULIC CHUCK	D15-46
◎	SHRINK FIT HOLDER	D47-72
◎	POWER MILLING CHUCK	D161-176
◎	ER COLLET CHUCK	D73-116
◎	SK SLIM CHUCK	D183-201

Unit : mm

EDP No.	Corner Radius	Mill Diameter	Shank Diameter	Length of Cut	Length Below Shank	Overall Length	Neck Diameter
	R	D1	D2	L1	L3	L2	D3
GM839020	R0.2	2.0	6	2.5	5	50	1.9
GM839030	R0.3	3.0	6	4	7	50	2.8
GM839040	R0.4	4.0	6	5	9	50	3.7
GM839060	R0.6	6.0	6	7	14	55	5.6
GM839080	R0.8	8.0	8	10	18	60	7.4
GM839100	R1.0	10.0	10	12	25	70	9.4
GM839120	R1.2	12.0	12	15	30	80	11.4

Mill Dia. Tolerance (mm)	Shank Dia. Tolerance
0 ~ -0.03	h5

◎ : Excellent ○ : Good

ISO Material Description	P									M					K						
	Non-alloy steel			Low alloy steel			High alloyed steel, and tool steel			Stainless steel			Grey cast iron		Nodular cast iron		Malleable cast iron				
VDI 3323	1	2	3	4	5	6	7	8	9	10	11	12	13	14	15	16	17	18	19	20	
HRc	13	25	28	32	30	10	29	32	38	15	35	15	23	10	10	26	3	25	21		
HB	125	190	250	270	300	180	275	300	350	200	325	200	240	180	180	260	160	250	130	230	
Recommend	○	○	○	◎	◎	○	◎	◎	◎	◎	◎	○	○	○	○	○	○	○	○	○	○

ISO Material Description	N					S					H										
	Aluminum-wrought alloy		Aluminum-cast, alloyed		Copper and Copper Alloys (Bronze / Brass)	Non Metallic Materials		Heat Resistant Super Alloys			Titanium Alloys		Hardened steel	Chilled Cast Iron	Hardened Cast Iron						
VDI 3323	21	22	23	24	25	26	27	28	29	30	31	32	33	34	35	36	37	38	39	40	41
HRc											15	30	25	38	34			55	60	42	55
HB	60	100	75	90	130	110	90	100			200	280	250	350	320	400 Rm	1050 Rm	550	630	400	550
Recommend																		○	◎	○	○

CARBIDE, 4 FLUTE LONG LENGTH CORNER RADIUS

- **VOLLHARTMETALL, 4 SCHNEIDEN LANG ECKENRADIUS**
- **Fraise carbure, 4 dents, torique, longue**
- **4 TAGLIENTI, TORICA, SERIE LUNGA**

- ▶ Designed to machine tool steels, alloy steels, mold steels and other hardened materials.
- ▶ 4 flute allows for better workpiece finishes.
- ▶ Increased production.

- ▶ Zur Bearbeitung von Werkzeugstählen, Legierten Stählen, Stahlguß und gehärteten Stählen.
- ▶ 4 Schneiden für bessere Oberflächengüte des Werkstücks.
- ▶ Gesteigerte Produktivität.

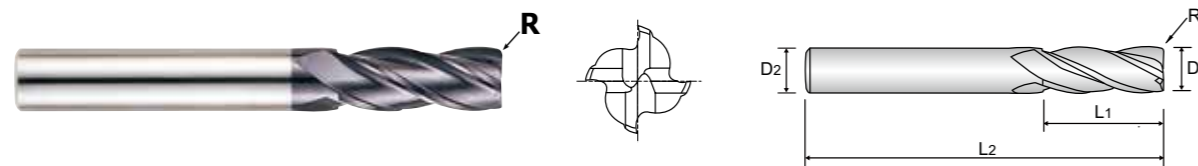

CARBIDE 4 30° PLAIN Coating Y p.C366

Recommended ToolHolder: HYDRAULIC CHUCK (D15-46), SHRINK FIT HOLDER (D47-72), POWER MILLING CHUCK (D161-176), ER COLLET CHUCK (D73-116), SK SLIM CHUCK (D183-201)

Unit : mm

EDP No.	Corner Radius	Mill Diameter	Shank Diameter	Length of Cut	Overall Length
	R	D1	D2	L1	L2
GM819030	R0.3	3.0	6	12	50
GM819040	R0.3	4.0	6	15	50
GM819911	R0.5	4.0	6	15	50
GM819912	R0.5	5.0	6	20	60
GM819060	R0.5	6.0	6	20	60
GM819901	R1.0	6.0	6	20	60
GM819080	R0.5	8.0	8	25	70
GM819902	R1.0	8.0	8	25	70
GM819904	R2.0	8.0	8	25	70
GM819100	R0.5	10.0	10	30	90
GM819905	R1.0	10.0	10	30	90
GM819906	R1.5	10.0	10	30	90
GM819907	R2.0	10.0	10	30	90
GM819120	R0.5	12.0	12	30	90
GM819908	R1.0	12.0	12	30	90
GM819909	R1.5	12.0	12	30	90
GM819910	R2.0	12.0	12	30	90
GM819160	R0.5	16.0	16	50	110
GM819916	R1.0	16.0	16	50	110
GM819918	R2.0	16.0	16	50	110
GM819921	R2.0	20.0	20	55	110

Mill Dia. Tolerance (mm)	Shank Dia. Tolerance
0 ~ - 0.03	h5

◎ : Excellent ○ : Good

ISO Material Description	P										M						K					
	Non-alloy steel					Low alloy steel					High alloyed steel, and tool steel		Stainless steel				Grey cast iron		Nodular cast iron		Malleable cast iron	
VDI 3323	1	2	3	4	5	6	7	8	9	10	11	12	13	14	15	16	17	18	19	20		
HRc	13	25	28	32	32	10	29	32	38	15	35	15	23	10	10	26	3	25	21	21		
HB	125	190	250	270	300	180	275	300	350	200	325	200	240	180	180	260	160	250	130	230		
Recommend	○	○	○	◎	◎	○	◎	◎	◎	◎	○	○	○	○	○	○	○	○	○	○	○	

ISO Material Description	N										S						H					
	Aluminum-wrought alloy		Aluminum-cast, alloyed				Copper and Copper Alloys (Bronze / Brass)				Non Metallic Materials		Heat Resistant Super Alloys				Titanium Alloys		Hardened steel	Chilled Cast Iron	Hardened Cast Iron	
VDI 3323	21	22	23	24	25	26	27	28	29	30	31	32	33	34	35	36	37	38	39	40	41	
HRc											15	30	25	38	34			55	60	42	55	
HB	60	100	75	90	130	110	90	100			200	280	250	350	320	400 Rm	1050 Rm	550	630	400	550	
Recommend											○	○	○	○	○	○	○	○	○	◎	○	

CARBIDE, 2 FLUTE MINIATURE

- **VOLLHARTMETALL, 2 SCHNEIDEN MINI**
- **Fraise carbure, 2 dents, micro-fraise**
- **2 TAGLIENTI, MINI**

- ▶ High precision milling in medical, optical, electronics and aerospace industries.
- ▶ Excellent performance on hardened steel

- ▶ Hochpräzises Fräsen für Medizintechnik, Optik, Elektronik und Raumfahrt.
- ▶ Ausgezeichnete Leistung bei der Bearbeitung von gehärtetem Stahl.

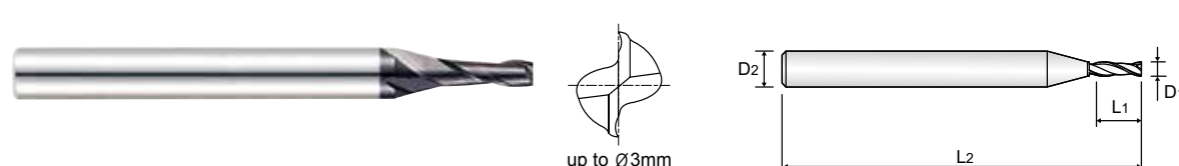

CARBIDE 2 30° PLAIN Coating Y p.C367

Recommended ToolHolder: HYDRAULIC CHUCK (D15-46), SHRINK FIT HOLDER (D47-72), POWER MILLING CHUCK (D161-176), ER COLLET CHUCK (D73-116), SK SLIM CHUCK (D183-201)

Unit : mm

EDP No.	Mill Diameter	Shank Diameter	Length of Cut	Overall Length
	D1	D2	L1	L2
GM810004	0.4	3	0.8	40
GM810005	0.5	3	1	40
GM810006	0.6	3	1.2	40
GM810007	0.7	3	1.4	40
GM810008	0.8	3	1.6	40
GM810009	0.9	3	2	40
GM810010	1.0	4	2.5	40
GM810901	1.0	6	2.5	40
GM810012	1.2	4	4	40
GM810014	1.4	4	4	40
GM810015	1.5	4	4	40
GM810902	1.5	6	4	40
GM810020	2.0	4	6	40
GM810903	2.0	6	6	40
GM810025	2.5	4	8	40
GM810030	3.0	6	8	45

Mill Dia. Tolerance (mm)	Shank Dia. Tolerance
0 ~ - 0.03	h5

▶ NEXT PAGE

◎ : Excellent ○ : Good

ISO Material Description	P										M						K					
	Non-alloy steel					Low alloy steel					High alloyed steel, and tool steel		Stainless steel				Grey cast iron		Nodular cast iron		Malleable cast iron	
VDI 3323	1	2	3	4	5	6	7	8	9	10	11	12	13	14	15	16	17	18	19	20		
HRc	13	25	28	32	32	10	29	32	38	15	35	15	23	10	10	26	3	25	21	21		
HB	125	190	250	270	300	180	275	300	350	200	325	200	240	180	180	260	160	250	130	230		
Recommend	○	○	○	◎	◎	○	◎	◎	◎	◎	○	○	○	○	○	○	○	○	○	○	○	

ISO Material Description	N										S						H					
	Aluminum-wrought alloy		Aluminum-cast, alloyed				Copper and Copper Alloys (Bronze / Brass)				Non Metallic Materials		Heat Resistant Super Alloys				Titanium Alloys		Hardened steel	Chilled Cast Iron	Hardened Cast Iron	
VDI 3323	21	22	23	24	25	26	27	28	29	30	31	32	33	34	35	36	37	38	39	40	41	
HRc											15	30	25	38	34			55	60	42	55	
HB	60	100	75	90	130	110	90	100			200	280	250	350	320	400 Rm	1050 Rm	550	630	400	550	
Recommend											○	○	○	○	○	○	○	○	○	◎	○	

HSS

HSS

CBN
END MILLS

CBN
END MILLS

i-Xmill
END MILLS

i-Xmill
END MILLS

i-SMART
MODULAR
END MILLS

i-SMART
MODULAR
END MILLS

X5070
END MILLS

X5070
END MILLS

4G MILL
END MILLS

4G MILL
END MILLS

X-POWER
PRO
END MILLS

X-POWER
PRO
END MILLS

TitaNox-
POWER
END MILLS

TitaNox-
POWER
END MILLS

JET-POWER
END MILLS

JET-POWER
END MILLS

V7 PLUS
END MILLS

V7 PLUS
END MILLS

ALU-POWER
HPC
END MILLS

ALU-POWER
HPC
END MILLS

ALU-
POWER
END MILLS

ALU-
POWER
END MILLS

D-POWER
GRAPHITE
END MILLS

D-POWER
GRAPHITE
END MILLS

CRX S
END MILLS

CRX S
END MILLS

K-2
END MILLS

K-2
END MILLS

ONLY ONE
COATED PM60
END MILLS

ONLY ONE
COATED PM60
END MILLS

TANK-
POWER
END MILLS

TANK-
POWER
END MILLS

GENERAL
HSS
END MILLS

GENERAL
HSS
END MILLS

MILLING
CUTTERS

MILLING
CUTTERS

TECHNICAL
DATA

TECHNICAL
DATA



PLAIN SHANK **GM810** SERIES

PLAIN SHANK **GM883** SERIES

CARBIDE, 2 FLUTE SHORT LENGTH

- **VOLLHARTMETALL, 2 SCHNEIDEN KURZ**
- () **Fraise carbure, 2 dents, courte**
- () **2 TAGLIENTI, SERIE CORTA**

- ▶ Designed to machine tool steels, alloy steels, mold steels and other hardened materials.
- ▶ Superior workpiece finishes.
- ▶ Increased feed rates.

- ▶ Zur Bearbeitung: Werkzeugstählen, Legierten Stählen, Stahlguß und gehärteten Stählen.
- ▶ Bessere Werkstückoberflächen.
- ▶ Höhere Vorschübe.

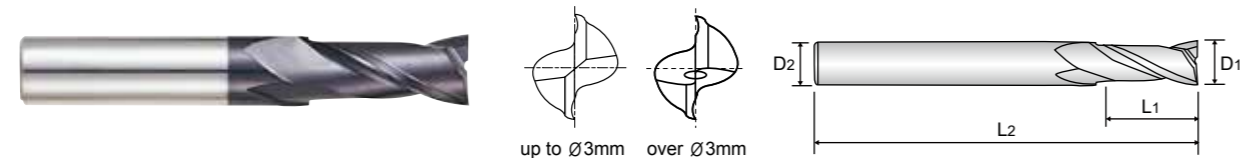

Plain Shank		Page
◎	HYDRAULIC CHUCK	D15-46
◎	SHRINK FIT HOLDER	D47-72
◎	POWER MILLING CHUCK	D161-176
○	ER COLLET CHUCK	D73-116
○	SK SLIM CHUCK	D183-201

EDP No.	Mill Diameter	Shank Diameter	Length of Cut	Overall Length
	D1	D2	L1	L2
GM810035	3.5	6	10	45
GM810040	4.0	6	11	45
GM810050	5.0	6	13	50
GM810060	6.0	6	13	50
GM810070	7.0	8	16	60
GM810080	8.0	8	19	60
GM810090	9.0	10	19	70
GM810100	10.0	10	22	70
GM810110	11.0	12	22	75
GM810120	12.0	12	26	75
GM810140	14.0	14	26	85
GM810160	16.0	16	32	100
GM810180	18.0	18	32	100
GM810200	20.0	20	38	105

Mill Dia. Tolerance (mm)	Shank Dia. Tolerance
0 ~ - 0.03	h5

◎ : Excellent ○ : Good

ISO Material Description	P						M			K										
	Non-alloy steel			Low alloy steel			High alloyed steel, and tool steel			Stainless steel										
VDI 3323	1	2	3	4	5	6	7	8	9	10	11	12	13	14	15	16	17	18	19	20
HRc	13	25	28	32	38	42	48	52	58	63	68	73	78	83	88	93	98	103	108	113
HB	125	190	250	270	300	350	380	420	450	500	550	600	650	700	750	800	850	900	950	1000
Recommend	○	○	○	◎	◎	◎	◎	◎	○	○	○	○	○	○	○	○	○	○	○	○

CARBIDE, 2 FLUTE for RIB PROCESSING

- **VOLLHARTMETALL, 2 SCHNEIDEN für SCHMALE RIPPEN**
- () **Fraise carbure, 2 dents pour usinage de rainure**
- () **2 TAGLIENTI, SCARICATA PER NERVATURE**

- ▶ Designed for rib processing on various materials.
- ▶ Superior workpiece finishes.
- ▶ Increased feed rates.

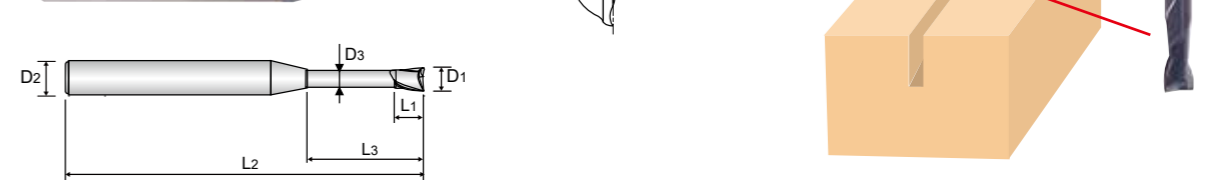

Plain Shank		Page
◎	HYDRAULIC CHUCK	D15-46
◎	SHRINK FIT HOLDER	D47-72
◎	POWER MILLING CHUCK	D161-176
○	ER COLLET CHUCK	D73-116
○	SK SLIM CHUCK	D183-201

EDP No.	Mill Diameter	Shank Diameter	Length of Cut	Length Below Shank	Overall Length	Neck Diameter
	D1	D2	L1	L3	L2	D3
GM883004	0.4	4	0.6	2	45	0.37
GM883005	0.5	4	0.7	2	45	0.45
GM883988	0.5	4	0.7	4	45	0.45
GM883820	0.7	4	1	3	45	0.65
GM883008	0.8	4	1.2	4	45	0.75
GM883908	0.8	4	1.2	6	45	0.75
GM883996	1.0	4	1.5	4	45	0.95
GM883010	1.0	4	1.5	6	45	0.95
GM883912	1.0	4	1.5	8	45	0.95
GM883913	1.0	4	1.5	10	45	0.95
GM883914	1.0	4	1.5	12	45	0.95
GM883997	1.0	4	1.5	16	50	0.95
GM883998	1.0	4	1.5	20	55	0.95
GM883012	1.2	4	1.8	6	45	1.15
GM883015	1.5	4	2.3	6	45	1.45
GM883923	1.5	4	2.3	8	45	1.45
GM883924	1.5	4	2.3	10	45	1.45
GM883925	1.5	4	2.3	12	45	1.45
GM883927	1.5	4	2.3	16	50	1.45
GM883810	1.5	4	2.3	20	55	1.45

Mill Dia. Tolerance (mm)	Shank Dia. Tolerance
0 ~ - 0.015	h5

▶ NEXT PAGE

◎ : Excellent ○ : Good

ISO Material Description	P						M			K										
	Non-alloy steel			Low alloy steel			High alloyed steel, and tool steel			Stainless steel										
VDI 3323	1	2	3	4	5	6	7	8	9	10	11	12	13	14	15	16	17	18	19	20
HRc	13	25	28	32	38	42	48	52	58	63	68	73	78	83	88	93	98	103	108	113
HB	125	190	250	270	300	350	380	420	450	500	550	600	650	700	750	800	850	900	950	1000
Recommend	○	○	○	◎	◎	◎	◎	◎	○	○	○	○	○	○	○	○	○	○	○	○



PLAIN SHANK GM883 SERIES

CARBIDE, 2 FLUTE for RIB PROCESSING

VOLLHARTMETALL, 2 SCHNEIDEN für SCHMALE RIPPEN
Fraise carbure, 2 dents pour usinage de rainure
2 TAGLIANTI, SCARICATA PER NERVATURE

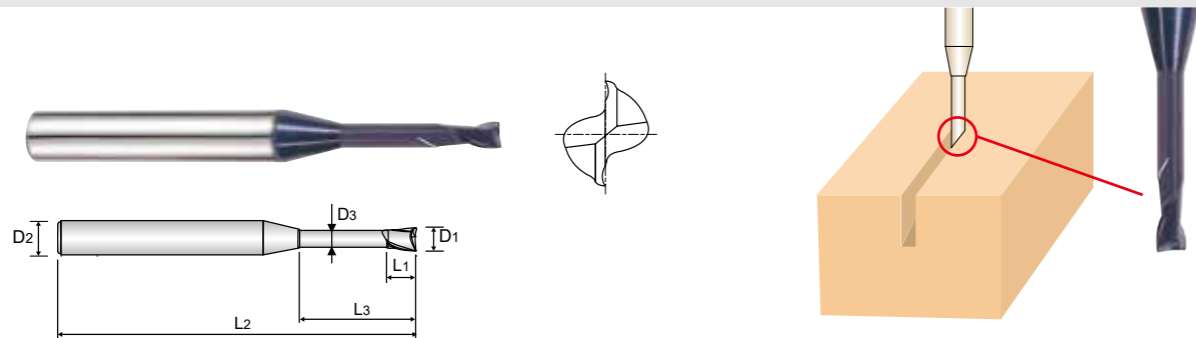

Recommended ToolHolder table with columns for Plain Shank and Page, listing hydraulic chucks, shrink fit holders, power milling chucks, and ER collet chucks.

Unit : mm

Main specification table with columns: EDP No., Mill Diameter (D1), Shank Diameter (D2), Length of Cut (L1), Length Below Shank (L3), Overall Length (L2), Neck Diameter (D3). Lists 34 models from GM883946 to GM883983.

Mill Dia. Tolerance (mm) and Shank Dia. Tolerance table showing 0 ~ - 0.015 mm for mill diameter and h5 for shank diameter.

NEXT PAGE

ISO material compatibility chart with columns for ISO, P (Non-alloy steel, Low alloy steel, High alloyed steel, Stainless steel, Grey cast iron, Nodular cast iron, Malleable cast iron), N (Aluminum, Copper, Non-Metallic), S (Heat Resistant Super Alloys, Titanium Alloys), H (Hardened steel, Chilled Cast Iron, Hardened Cast Iron).



PLAIN SHANK GM883 SERIES

CARBIDE, 2 FLUTE for RIB PROCESSING

VOLLHARTMETALL, 2 SCHNEIDEN für SCHMALE RIPPEN
Fraise carbure, 2 dents pour usinage de rainure
2 TAGLIANTI, SCARICATA PER NERVATURE

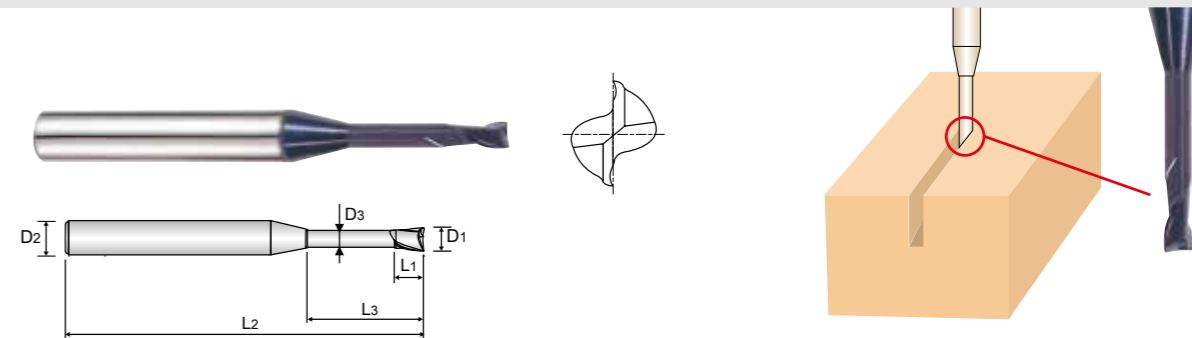

Recommended ToolHolder table with columns for Plain Shank and Page, listing hydraulic chucks, shrink fit holders, power milling chucks, and ER collet chucks.

Unit : mm

Main specification table with columns: EDP No., Mill Diameter (D1), Shank Diameter (D2), Length of Cut (L1), Length Below Shank (L3), Overall Length (L2), Neck Diameter (D3). Lists 10 models from GM883801 to GM883809.

Mill Dia. Tolerance (mm) and Shank Dia. Tolerance table showing 0 ~ - 0.015 mm for mill diameter and h5 for shank diameter.

CARBIDE, 3 FLUTE 38° HELIX SHORT LENGTH

VOLLHARTMETALL, 3 SCHNEIDEN 38° RECHTSSPIRALE KURZ
Fraise carbure, 3 dents, hélice 38°, courte
3 TAGLIENTI, ELICA 38°, SERIE CORTA

- ▶ Designed to machine tool steels, alloy steels, mold steels and other hardened materials.
- ▶ Possesses the advantage of 2 flute and 4 flute end mill.
- ▶ Superior workpiece finishes.

- ▶ Zur Bearbeitung: Werkzeugstählen, Legierten Stählen, Stahlguß und gehärteten Stählen.
- ▶ Besitzt die Vorteile von 2 und 4 Schneiden Fräsern
- ▶ Bessere Werkstückoberflächen

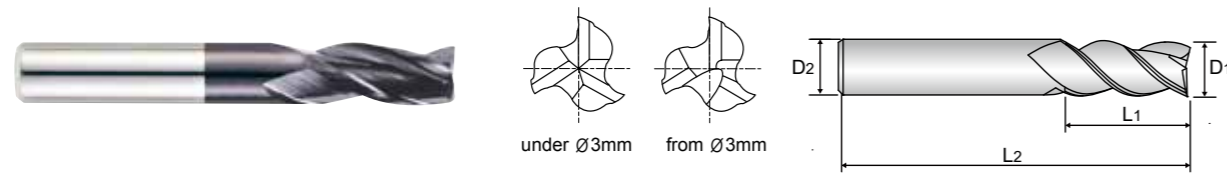

CARBIDE 3 38° PLAIN Coating Y p.C370-371

Plain Shank	Page
HYDRAULIC CHUCK	D15-46
SHRINK-FIT HOLDER	D47-72
POWER MILLING CHUCK	D161-176
ER COLLET CHUCK	D73-116
SK SLIM CHUCK	D183-201

Unit : mm

EDP No.	Mill Diameter D1	Shank Diameter D2	Length of Cut L1	Overall Length L2
GM895010	1.0	3	2.5	38
GM895015	1.5	4	5	50
GM895025	2.5	3	7	38
GM895030	3.0	3	10	38
GM895901	3.0	6	10	50
GM895040	4.0	4	12	50
GM895903	4.0	6	12	50
GM895050	5.0	5	14	50
GM895904	5.0	6	14	57
GM895060	6.0	6	16	57
GM895080	8.0	8	20	63
GM895100	10.0	10	22	72
GM895120	12.0	12	25	73
GM895160	16.0	16	32	82

Mill Dia. Tolerance (mm)	Shank Dia. Tolerance
0 ~ - 0.03	h5

◎ : Excellent ○ : Good

ISO Material Description	P										M				K						
	Non-alloy steel					Low alloy steel					High alloyed steel, and tool steel		Stainless steel		Grey cast iron		Nodular cast iron		Malleable cast iron		
VDI 3323	1	2	3	4	5	6	7	8	9	10	11	12	13	14	15	16	17	18	19	20	
HRc	13	25	28	32	30	29	29	32	38	15	35	15	23	10	10	26	3	25	21	21	
HB	125	190	250	270	300	180	275	300	350	200	325	200	240	180	180	260	160	250	130	230	
Recommend	○	○	○	◎	◎	○	◎	◎	◎	◎	◎	○	○	○	○	○	○	○	○	○	○

CARBIDE, 4 FLUTE SHORT LENGTH

VOLLHARTMETALL, 4 SCHNEIDEN KURZ
Fraise carbure, 4 dents, courte
4 TAGLIENTI, SERIE CORTA

- ▶ Designed to machine tool steels, alloy steels, mold steels and other hardened materials.
- ▶ 4 flute allows for better workpiece finishes.
- ▶ Increased Productivity.

- ▶ Zur Bearbeitung: Werkzeugstählen, Legierten Stählen, Stahlguß und gehärteten Stählen.
- ▶ 4 Schneiden erzeugen eine bessere Oberfläche des Werkstücks.
- ▶ Höhere Produktivität.

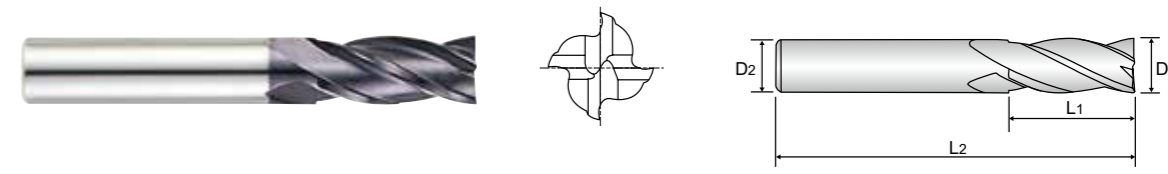

CARBIDE 4 30° PLAIN Coating Y p.C372

Plain Shank	Page
HYDRAULIC CHUCK	D15-46
SHRINK-FIT HOLDER	D47-72
POWER MILLING CHUCK	D161-176
ER COLLET CHUCK	D73-116
SK SLIM CHUCK	D183-201

Unit : mm

EDP No.	Mill Diameter D1	Shank Diameter D2	Length of Cut L1	Overall Length L2
GM811020	2.0	4	6	40
GM811901	2.0	6	6	40
GM811025	2.5	4	8	40
GM811902	2.5	6	8	40
GM811030	3.0	6	8	45
GM811035	3.5	6	10	45
GM811040	4.0	6	11	45
GM811045	4.5	6	11	45
GM811050	5.0	6	13	50
GM811060	6.0	6	13	50
GM811080	8.0	8	19	60
GM811100	10.0	10	22	70
GM811120	12.0	12	26	75
GM811140	14.0	14	26	85
GM811160	16.0	16	32	100
GM811200	20.0	20	38	105
GM811250	25.0	25	45	120

Mill Dia. Tolerance (mm)	Shank Dia. Tolerance
0 ~ - 0.03	h5

◎ : Excellent ○ : Good

ISO Material Description	P										M				K						
	Non-alloy steel					Low alloy steel					High alloyed steel, and tool steel		Stainless steel		Grey cast iron		Nodular cast iron		Malleable cast iron		
VDI 3323	1	2	3	4	5	6	7	8	9	10	11	12	13	14	15	16	17	18	19	20	
HRc	13	25	28	32	30	29	29	32	38	15	35	15	23	10	10	26	3	25	21	21	
HB	125	190	250	270	300	180	275	300	350	200	325	200	240	180	180	260	160	250	130	230	
Recommend	○	○	○	◎	◎	○	◎	◎	◎	◎	◎	○	○	○	○	○	○	○	○	○	○



PLAIN SHANK **GM817** SERIES

CARBIDE, 4 FLUTE LONG LENGTH

● **VOLLHARTMETALL, 4 SCHNEIDEN LANG**
 (●) **Fraise carbure, 4 dents, longue**
 (●) **4 TAGLIENTI, SERIE LUNGA**

- ▶ Designed to machine tool steels, alloy steels, mold steels and other hardened materials.
- ▶ 4 flute allows for better workpiece finishes.
- ▶ Increased Productivity.

- ▶ Zur Bearbeitung: Werkzeugstählen, Legierten Stählen, Stahlguß und gehärteten Stählen.
- ▶ 4 Schneiden erzeugen eine bessere Oberfläche des Werkstücks.
- ▶ Höhere Produktivität.

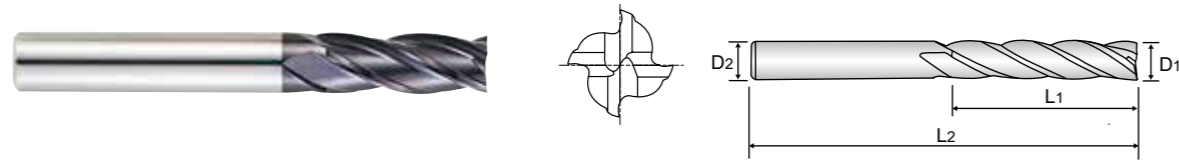

Recommended ToolHolder	Plain Shank	Page
⊙	HYDRAULIC CHUCK	D15-46
⊙	SHRINK FIT HOLDER	D47-72
⊙	POWER MILLING CHUCK	D161-176
⊙	ER COLLET CHUCK	D73-116
⊙	SK SLIM CHUCK	D183-201

Unit : mm

EDP No.	Mill Diameter	Shank Diameter	Length of Cut	Overall Length
	D1	D2	L1	L2
GM817020	2.0	4	8	40
GM817030	3.0	6	12	50
GM817040	4.0	6	15	50
GM817050	5.0	6	20	60
GM817060	6.0	6	20	60
GM817080	8.0	8	25	70
GM817100	10.0	10	30	90
GM817120	12.0	12	30	90
GM817140	14.0	16	40	110
GM817160	16.0	16	50	110
GM817200	20.0	20	55	110

Mill Dia. Tolerance (mm)	Shank Dia. Tolerance
0 ~ -0.03	h5

◎ : Excellent ○ : Good

ISO Material Description	P										M				K					
	Non-alloy steel					Low alloy steel					High alloyed steel, and tool steel		Stainless steel		Grey cast iron	Nodular cast iron		Malleable cast iron		
VDI 3323	1	2	3	4	5	6	7	8	9	10	11	12	13	14	15	16	17	18	19	20
HRc	13	25	28	32	38	10	29	32	38	15	35	15	23	10	10	26	3	25	21	
HB	125	190	250	270	300	180	275	300	350	200	325	200	240	180	180	260	160	250	130	230
Recommend	○	○	○	◎	◎	○	◎	◎	◎	◎	◎	○	○	○	○	○	○	○	○	○

ISO Material Description	N						S						H								
	Aluminum-wrought alloy		Aluminum-cast, alloyed		Copper and Copper Alloys (Bronze / Brass)		Non Metallic Materials		Heat Resistant Super Alloys			Titanium Alloys			Hardened steel	Chilled Cast Iron	Hardened Cast Iron				
VDI 3323	21	22	23	24	25	26	27	28	29	30	31	32	33	34	35	36	37	38	39	40	41
HRc	21	22	23	24	25	26	27	28	29	30	15	30	25	38	34	55	60	42	55		
HB	60	100	75	90	130	110	90	100			200	280	250	350	320	400 Rm	1050 Rm	550	630	400	550
Recommend	○	○	○	○	○	○	○	○	○	○	○	○	○	○	○	○	○	○	○	○	○



PLAIN SHANK **GM812** SERIES

CARBIDE, 6&8 FLUTE 45° HELIX LONG LENGTH

● **VOLLHARTMETALL, 6&8 SCHNEIDEN 45° RECHTSSPIRALE LANG**
 (●) **Fraise carbure, 6&8 dents, hélice 45°, longue**
 (●) **6&8 TAGLIENTI, ELICA 45°, SERIE**

- ▶ Designed to machine hardened materials.
- ▶ High speed cutting and finish milling with high feed rates.
- ▶ Superior workpiece finishes.
- ▶ Superior wear resistance.
- ▶ Suitable for dry milling.

- ▶ Geeignet zum Fräsen von gehärteten Stählen.
- ▶ Hochgeschwindigkeitsfräsen und Finishing mit erhöhtem Vorschub.
- ▶ Bessere Werkstückoberflächen
- ▶ Höhere Verschleißfestigkeit.
- ▶ Geeignet zum Trocken-Fräsen.

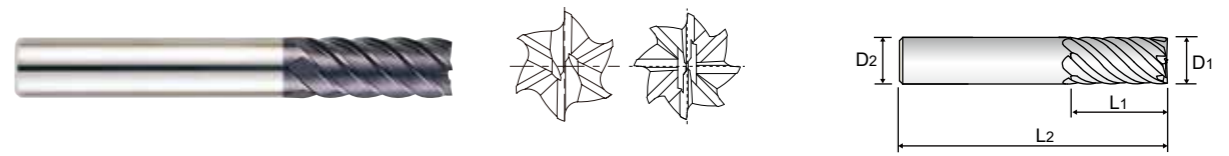

Recommended ToolHolder	Plain Shank	Page
⊙	HYDRAULIC CHUCK	D15-46
⊙	SHRINK FIT HOLDER	D47-72
⊙	POWER MILLING CHUCK	D161-176
⊙	ER COLLET CHUCK	D73-116
⊙	SK SLIM CHUCK	D183-201

p.C374

Unit : mm

EDP No.	Mill Diameter	Shank Diameter	Length of Cut	Overall Length	No. of Flute
	D1	D2	L1	L2	
GM812060	6.0	6	13	57	6
GM812080	8.0	8	19	63	6
GM812100	10.0	10	22	72	6
GM812120	12.0	12	26	83	6
GM812160	16.0	16	32	92	6
GM812200	20.0	20	38	104	8

Mill Dia. Tolerance (mm)	Shank Dia. Tolerance
0 ~ -0.03	h5

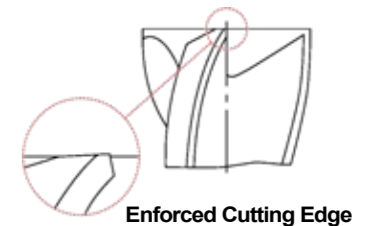

◎ : Excellent ○ : Good

ISO Material Description	P										M				K					
	Non-alloy steel					Low alloy steel					High alloyed steel, and tool steel		Stainless steel		Grey cast iron	Nodular cast iron		Malleable cast iron		
VDI 3323	1	2	3	4	5	6	7	8	9	10	11	12	13	14	15	16	17	18	19	20
HRc	13	25	28	32	38	10	29	32	38	15	35	15	23	10	10	26	3	25	21	
HB	125	190	250	270	300	180	275	300	350	200	325	200	240	180	180	260	160	250	130	230
Recommend	○	○	○	◎	◎	○	◎	◎	◎	◎	◎	○	○	○	○	○	○	○	○	○

ISO Material Description	N						S						H								
	Aluminum-wrought alloy		Aluminum-cast, alloyed		Copper and Copper Alloys (Bronze / Brass)		Non Metallic Materials		Heat Resistant Super Alloys			Titanium Alloys			Hardened steel	Chilled Cast Iron	Hardened Cast Iron				
VDI 3323	21	22	23	24	25	26	27	28	29	30	31	32	33	34	35	36	37	38	39	40	41
HRc	21	22	23	24	25	26	27	28	29	30	15	30	25	38	34	55	60	42	55		
HB	60	100	75	90	130	110	90	100			200	280	250	350	320	400 Rm	1050 Rm	550	630	400	550
Recommend	○	○	○	○	○	○	○	○	○	○	○	○	○	○	○	○	○	○	○	○	○

Vc = m/min.
fz = mm/tooth
RPM = rev./min.
FEED = mm/min.
Ap = mm

GM886 SERIES 2 FLUTE BALL NOSE RIB PROCESSING

Table with columns for ISO, VDI 3323, Material Description, Parameter, and Diameter (Ø) ranging from 0.5 to 1.4. Rows include material types like Non-alloy steel, Low alloy steel, High alloyed steel, and tool steel, with parameters Vc, fz, RPM, FEED, and Ap.

▶ NEXT PAGE

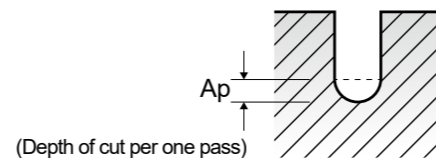

Vc = m/min.
fz = mm/tooth
RPM = rev./min.
FEED = mm/min.
Ap = mm

GM886 SERIES 2 FLUTE BALL NOSE RIB PROCESSING

Table with columns for VDI 3323, Diameter (Ø) ranging from 1.5 to 6.0, and parameters Vc, fz, RPM, FEED, and Ap for various material types.

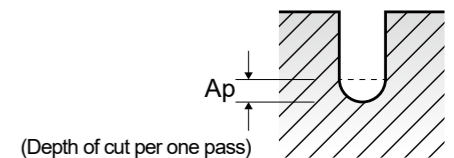



RECOMMENDED CUTTING CONDITIONS
EMPFOHLENE SCHNEIDPARAMETER



RECOMMENDED CUTTING CONDITIONS
EMPFOHLENE SCHNEIDPARAMETER

GM8A1 SERIES 2 FLUTE CORNER RADIUS RIB PROCESSING

GM839 SERIES 4 FLUTE CORNER RADIUS - SIDE CUTTING

Vc = m/min.
fz = mm/tooth
RPM = rev./min.
FEED = mm/min.
Ap = mm

Vc = m/min.
fz = mm/tooth
RPM = rev./min.
FEED = mm/min.

Table with columns: ISO, VDI 3323, Material Description, Parameter, Diameter (Ø) [2.0, 2.5, 3.0, 4.0, 5.0, 6.0]. Rows include material types like Non-alloy steel, Low alloy steel, High alloyed steel, and Hardened steel.

Table with columns: ISO, VDI 3323, Material Description, Ae, Ap, Parameter, Diameter (Ø) [2.0, 3.0, 4.0, 6.0, 8.0, 10.0, 12.0]. Rows include material types like Non-alloy steel, Low alloy steel, High alloyed steel, Grey cast iron, and Hardened steel.

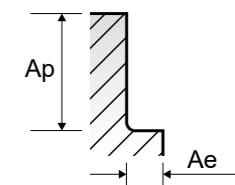
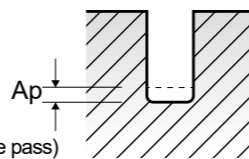

GM883 SERIES 2 FLUTE RIB PROCESSING

Vc = m/min.
fz = mm/tooth
RPM = rev./min.
FEED = mm/min.
Ap = mm

Table with columns for ISO, VDI 3323, Material Description, Diameter (Ø), and parameters Vc, fz, RPM, FEED, Ap for diameters 0.4 to 1.2. Includes material categories like Non-alloy steel, Low alloy steel, High alloyed steel, and Grey cast iron.

▶ NEXT PAGE

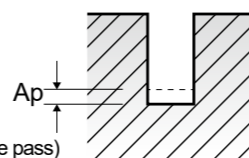

(Depth of cut per one pass)

GM883 SERIES 2 FLUTE RIB PROCESSING

Vc = m/min.
fz = mm/tooth
RPM = rev./min.
FEED = mm/min.
Ap = mm

Table with columns for VDI 3323, Parameter, and diameters 1.4 to 6.0. Includes material categories like Non-alloy steel, Low alloy steel, High alloyed steel, and Grey cast iron.

(Depth of cut per one pass)

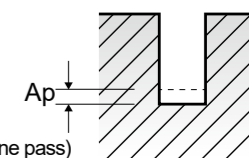



GM814 SERIES

3&4 FLUTE ROUGHING - SIDE CUTTING

Vc = m/min.
fz = mm/tooth
RPM = rev./min.
FEED = mm/min.

ISO	VDI 3323	Material Description	Ae	Ap	Parameter	Diameter (Ø)					
						6.0	8.0	10.0	12.0	16.0	20.0
P	1-4	Non-alloy steel	0.3D	1.5D	Vc	310	305	305	315	315	315
					fz	0.05	0.067	0.063	0.075	0.1	0.113
					RPM	16446	12136	9708	8356	6267	5013
					FEED	2467	2439	2447	2507	2507	2266
	5	Non-alloy steel	0.3D	1.5D	Vc	245	245	250	240	255	240
					fz	0.023	0.030	0.028	0.033	0.040	0.039
					RPM	12998	9748	7958	6366	5073	3820
					FEED	897	877	891	840	812	596
	6-7	Low alloy steel	0.3D	1.5D	Vc	310	305	305	315	315	315
					fz	0.05	0.067	0.063	0.075	0.1	0.113
					RPM	16446	12136	9708	8356	6267	5013
					FEED	2467	2439	2447	2507	2507	2266
8-9	Low alloy steel	0.3D	1.5D	Vc	245	245	250	240	255	240	
				fz	0.023	0.030	0.028	0.033	0.040	0.039	
				RPM	12998	9748	7958	6366	5073	3820	
				FEED	897	877	891	840	812	596	
10	High alloyed steel, and tool steel	0.3D	1.5D	Vc	310	305	305	315	315	315	
				fz	0.05	0.067	0.063	0.075	0.1	0.113	
				RPM	16446	12136	9708	8356	6267	5013	
				FEED	2467	2439	2447	2507	2507	2266	
11.1 11.2	High alloyed steel, and tool steel	0.3D	1.5D	Vc	245	245	250	240	255	240	
				fz	0.023	0.030	0.028	0.033	0.040	0.039	
				RPM	12998	9748	7958	6366	5073	3820	
				FEED	897	877	891	840	812	596	
M	14.1	Stainless steel	0.3D	1.5D	Vc	165	165	170	165	175	160
					fz	0.023	0.03	0.028	0.034	0.039	0.038
					RPM	8754	6565	5411	4377	3482	2546
					FEED	604	591	606	595	543	387
K	15-20	Grey cast iron Nodular cast iron Malleable cast iron	0.3D	1.5D	Vc	310	305	305	315	315	315
					fz	0.05	0.067	0.063	0.075	0.1	0.113
					RPM	16446	12136	9708	8356	6267	5013
					FEED	2467	2439	2447	2507	2507	2266
H	38.1 - 38.2	Hardened steel	0.05D	1.0D	Vc	65	65	65	65	65	65
					fz	0.026	0.033	0.036	0.039	0.034	0.038
	40	Chilled Cast Iron	0.3D	1.5D	RPM	3448	2586	2069	1724	1293	1035
					FEED	269	256	298	269	176	157
H	41	Hardened Cast Iron	0.05D	1.0D	Vc	245	245	250	240	255	240
					fz	0.023	0.030	0.028	0.033	0.040	0.039
					RPM	12998	9748	7958	6366	5073	3820
					FEED	897	877	891	840	812	596
H	41	Hardened Cast Iron	0.05D	1.0D	Vc	65	65	65	65	65	65
					fz	0.026	0.033	0.036	0.039	0.034	0.038
					RPM	3448	2586	2069	1724	1293	1035
					FEED	269	256	298	269	176	157

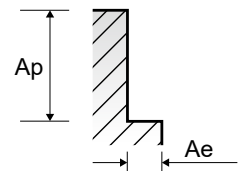



Leading Through Innovation

SOLID CARBIDE

TitaNox-POWER END MILLS

TitaNox-Power VHM - Schaftfräser

- High Speed Machining for Exotic Materials: Titanium and Stainless Steels
- Hochgeschwindigkeitsbearbeitung von Sonderwerkstoffen: Titan und rostfreie Stähle

SELECTION GUIDE



SERIES	GMG40 GMG41	GMG28 GMG29	GMG30 GMG31	GMG24 GMG25
FLUTE	4	5	5	5
HELIX ANGLE	43°/45°	43°/44°/45°	43°/44°/45°	43°/44°/45°
CUTTING EDGE SHAPE	CORNER RADIUS	CORNER RADIUS	CORNER RADIUS	SQUARE
SIZE MIN	D6.0	D6.0	D6.0	D6.0
SIZE MAX	D25.0	D25.0	D25.0	D25.0
PAGE	C380	C382	C383	C385

GMG26 GMG27	EHE54 EHE55
5	5
43°/44°/45°	40°
SQUARE	ROUGHING CORNER RADIUS
D6.0	D6.0
D25.0	D25.0
C386	C387
LONG LENGTH	-
Y-Coating	TiAlN

SOLID CARBIDE
TitaNox-POWER
END MILLS

High Speed Machining for Exotic Materials:
Titanium and Stainless Steels

LONG LENGTH DOUBLE CORE	SHORT LENGTH	LONG LENGTH	SHORT LENGTH
Y-Coating	Y-Coating	Y-Coating	Y-Coating



Please visit globalyg1.com/mat for material search

◎ : Excellent ○ : Good

Recommended cutting conditions : p. C388

ISO	VDI 3323	Material Description	Composition / Structure / Heat Treatment	HB	HRc	GMG40	GMG28	GMG30	GMG24
P	1	Non-alloy steel	About 0.15% C Annealed	125		○	○	○	○
	2		About 0.45% C Annealed	190	13	○	○	○	○
	3		About 0.45% C Quenched & Tempered	250	25	○	○	○	○
	4		About 0.75% C Annealed	270	28	○	○	○	○
	5		About 0.75% C Quenched & Tempered	300	32	○	○	○	○
	6	Low alloy steel	Annealed	180	10	○	○	○	○
	7		Quenched & Tempered	275	29	○	○	○	○
	8		Quenched & Tempered	300	32	○	○	○	○
	9		Quenched & Tempered	350	38	○	○	○	○
	10	High alloyed steel, and tool steel	Annealed	200	15	○	○	○	○
	11		Quenched & Tempered	325	35	○	○	○	○
M	12	Stainless steel	Ferritic / Martensitic Annealed	200	15	◎	◎	◎	◎
	13		Martensitic Quenched & Tempered	240	23	◎	◎	◎	◎
	14		Austenitic	180	10	◎	◎	◎	◎
K	15	Grey cast iron	Pearlitic / ferritic	180	10	○	○	○	○
	16		Pearlitic (Martensitic)	260	26	○	○	○	○
	17	Nodular cast iron	Ferritic	160	3	○	○	○	○
	18		Pearlitic	250	25	○	○	○	○
	19		Ferritic	130		○	○	○	○
20	Malleable cast iron	Pearlitic	230	21	○	○	○	○	
N	21	Aluminum-wrought alloy	Not Curable	60					
	22		Curable Hardened	100					
	23	Aluminum-cast, alloyed	≤ 12% Si, Not Curable	75					
	24		≤ 12% Si, Curable Hardened	90					
	25		> 12% Si, Not Curable	130					
	26	Copper and Copper Alloys (Bronze / Brass)	Cutting Alloys, PB>1%	110					
	27		CuZn, CuSnZn (Brass)	90					
	28	Non Metallic Materials	CuSn, lead-free copper and electrolytic copper	100					
	29		Duroplastic, Fiber Reinforced Plastic						
	30	Rubber, Wood, etc.							
S	31	Heat Resistant Super Alloys	Fe Based Annealed	200	15	○	○	○	○
	32		Cured	280	30	○	○	○	○
	33		Annealed	250	25	○	○	○	○
	34		Ni or Co Based Cured	350	38	○	○	○	○
	35		Cast	320	34	○	○	○	○
	36	Titanium Alloys	Pure Titanium	400 Rm		◎	◎	◎	◎
37	Alpha + Beta Alloys Hardened		1050 Rm		◎	◎	◎	◎	
H	38	Hardened steel	Hardened	550	55				
	39		Hardened	630	60				
	40	Chilled Cast Iron	Cast	400	42				
	41	Hardened Cast Iron	Hardened	550	55				

GMG26	EHE54	1
○		1
○		2
○		3
○		4
○		5
○		6
○		7
○		8
○		9
○		10
○		11
◎	○	12
◎	○	13
◎	○	14
○		15
○		16
○		17
○		18
○		19
○		20
		21
		22
		23
		24
		25
		26
		27
		28
		29
		30
○	○	31
○	○	32
○	○	33
○	○	34
○	○	35
◎	◎	36
◎	◎	37
		38
		39
		40
		41

HSS

CBN END MILLS

i-Xmill END MILLS

i-SMART MODULAR END MILLS

X5070 END MILLS

4G MILL END MILLS

X-POWER PRO END MILLS

TitaNox-POWER END MILLS

JET-POWER END MILLS

V7 PLUS END MILLS

ALU-POWER HPC END MILLS

ALU-POWER END MILLS

D-POWER GRAPHITE END MILLS

CRX S END MILLS

K-2 END MILLS

ONLY ONE COATED PM60 END MILLS

TANK-POWER END MILLS

GENERAL HSS END MILLS

MILLING CUTTERS

TECHNICAL DATA

CARBIDE, 4 FLUTE CORNER RADIUS with DOUBLE CORE

- VOLLHARTMETALL, 4 SCHNEIDEN ECKRADIUS mit DOPPELKERN
CARBURE, 4 DENTS, TORIQUE AVEC ÂME DOUBLE
FRESA IN MD, 4 TAGLIENTI, TORICA, DOUBLE CORE

Double core end mill has a unique flute design for excellent chip evacuation and higher rigidity.
The double core adds stability and aids chip flow, reducing tool deflection, improving dimensional stability and workpiece accuracy.

Der Doppelkern hat ein einzigartiges Schneiden Design für eine exzellente Spanabfuhr und bessere Zähigkeit.
Der Doppelkern erhöht die Stabilität und unterstützt den Spänefluss, reduziert die Werkzeugabdrängung, verbessert die Formstabilität und die Werkstückgenauigkeit.

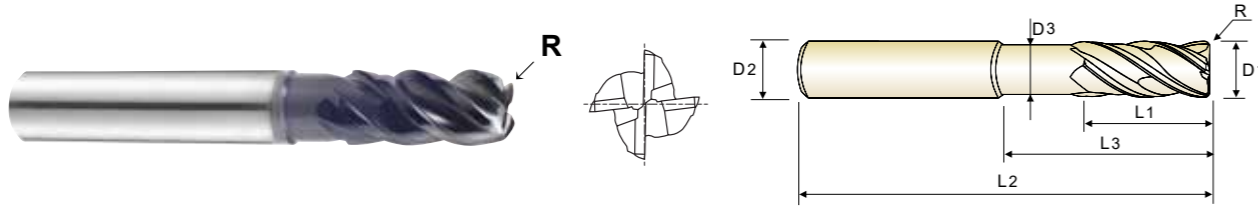

Product icons: CARBIDE, 4, 43°/45°, PLAIN, FLAT, Coating, Y, p.C388-389. Recommended Tool Holder table.

Table with 9 columns: EDP No., Corner Radius, Mill Diameter, Shank Diameter, Length of Cut, Length Below Shank, Overall Length, Neck Diameter. Lists models GMG40060 to GMG41160.

Unit : mm

Mill Dia. Tolerance (mm) 0 ~ - 0.03
Shank Dia. Tolerance h5
Shank Dia. ≥ Ø12 : h6

2 STEP CORE

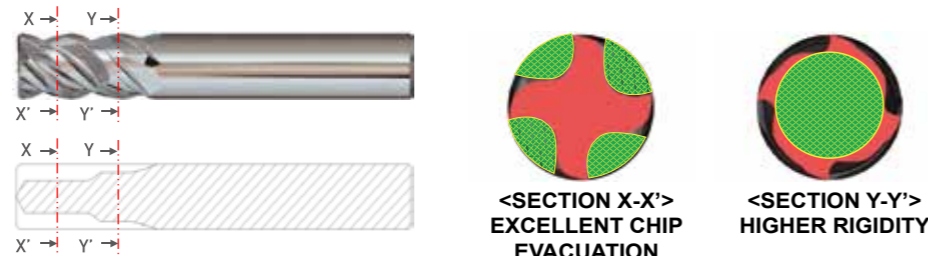

◎ : Excellent ○ : Good

ISO material compatibility chart with columns for Non-alloy steel, Low alloy steel, High alloyed steel, Stainless steel, Grey cast iron, Nodular cast iron, Malleable cast iron, Aluminum-wrought alloy, Aluminum-cast, alloyed, Copper and Copper Alloys, Non Metallic Materials, Heat Resistant Super Alloys, Titanium Alloys, Hardened steel, Chilled Cast Iron, Hardened Cast Iron.

CARBIDE, 4 FLUTE CORNER RADIUS with DOUBLE CORE

- VOLLHARTMETALL, 4 SCHNEIDEN ECKRADIUS mit DOPPELKERN
CARBURE, 4 DENTS, TORIQUE AVEC ÂME DOUBLE
FRESA IN MD, 4 TAGLIENTI, TORICA, DOUBLE CORE

Double core end mill has a unique flute design for excellent chip evacuation and higher rigidity.
The double core adds stability and aids chip flow, reducing tool deflection, improving dimensional stability and workpiece accuracy.

Der Doppelkern hat ein einzigartiges Schneiden Design für eine exzellente Spanabfuhr und bessere Zähigkeit.
Der Doppelkern erhöht die Stabilität und unterstützt den Spänefluss, reduziert die Werkzeugabdrängung, verbessert die Formstabilität und die Werkstückgenauigkeit.

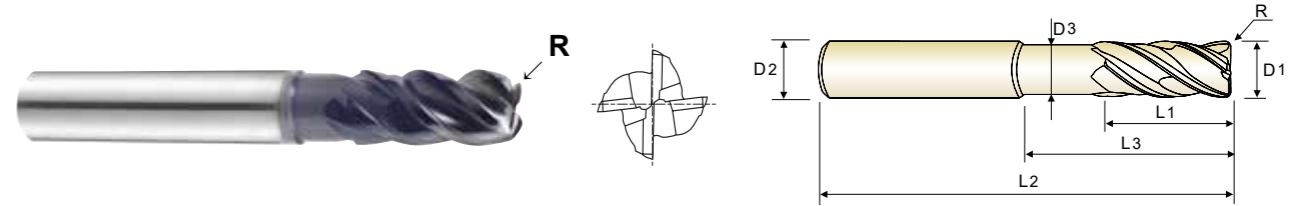

Product icons: CARBIDE, 4, 43°/45°, PLAIN, FLAT, Coating, Y, p.C388-389. Recommended Tool Holder table.

Table with 9 columns: EDP No., Corner Radius, Mill Diameter, Shank Diameter, Length of Cut, Length Below Shank, Overall Length, Neck Diameter. Lists models GMG40913 to GMG41925.

Unit : mm

Mill Dia. Tolerance (mm) 0 ~ - 0.03
Shank Dia. Tolerance h5
Shank Dia. ≥ Ø12 : h6

2 STEP CORE

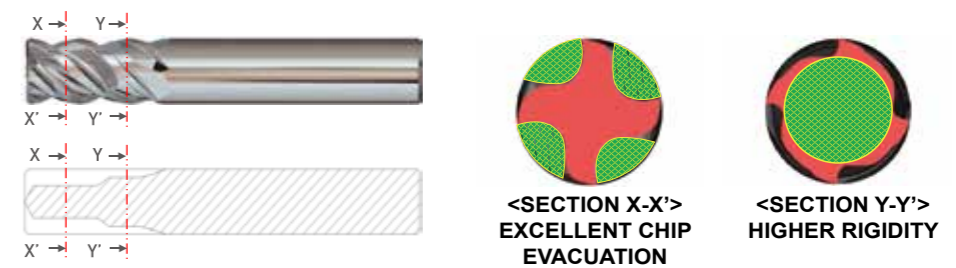

◎ : Excellent ○ : Good

ISO material compatibility chart with columns for Non-alloy steel, Low alloy steel, High alloyed steel, Stainless steel, Grey cast iron, Nodular cast iron, Malleable cast iron, Aluminum-wrought alloy, Aluminum-cast, alloyed, Copper and Copper Alloys, Non Metallic Materials, Heat Resistant Super Alloys, Titanium Alloys, Hardened steel, Chilled Cast Iron, Hardened Cast Iron.



PLAIN SHANK **GMG28** SERIES
FLAT SHANK **GMG29** SERIES

CARBIDE, 5 FLUTE CORNER RADIUS SHORT LENGTH

- VOLLHARTMETALL, 5 SCHNEIDEN KURZ mit ECKRADIUS
- CARBURE, 5 DENTS, TORIQUE, SÉRIE COURTE
- FRESA IN MD, 5 TAGLIENTI, SERIE CORTA, TORICA

- ▶ Excellent performance results and long tool life when machining Titanium and other tough materials.
- ▶ This tool has high rigidity of flute so that is possible to use for heavy profile and high speed milling.
- ▶ For protecting Corner chipping of end teeth, Corner Radius & Chamfer are adopted.

- ▶ Exzellente Leistungsergebnisse und hohe Standzeiten beim Bearbeiten von Titan oder anderen robusten Materialien.
- ▶ Die Schneiden des Werkzeugs haben eine besondere Festigkeit, so dass es für schwere Profile und zum High-Speed-Fräsen geeignet ist.
- ▶ Durch die Fase und den Eckradius werden Ausbrüche verhindert.

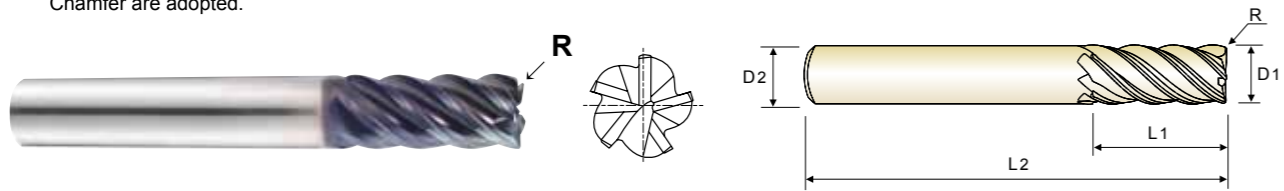

Flat Shank	Page	Plain Shank	Page
END MILL HOLDER	D118-137	POWER MILLING CHUCK	D161-176
-	-	HYDRAULIC CHUCK	D15-46
-	-	SHRINK FIT HOLDER	D47-72
-	-	ER COLLET CHUCK	D73-116

Unit : mm

EDP No.		Corner Radius	Mill Diameter	Shank Diameter	Length of Cut	Overall Length
PLAIN	FLAT	R	D1	D2	L1	L2
GMG28060	GMG29060	R0.5	6.0	6	10	54
GMG28080	GMG29080	R0.5	8.0	8	12	58
GMG28100	GMG29100	R0.5	10.0	10	14	66
GMG28120	GMG29120	R0.5	12.0	12	16	73
GMG28160	GMG29160	R1.0	16.0	16	22	82
GMG28200	GMG29200	R1.0	20.0	20	26	92
GMG28250	GMG29250	R1.0	25.0	25	29	100

Mill Dia. Tolerance (mm)	Shank Dia. Tolerance
0 ~ - 0.03	h5 * Shank Dia. ≥ Ø12 : h6

◎ : Excellent ○ : Good

ISO Material Description	P										M				K					
	Non-alloy steel					Low alloy steel					High alloyed steel, and tool steel		Stainless steel		Grey cast iron	Nodular cast iron		Malleable cast iron		
VDI 3323	1	2	3	4	5	6	7	8	9	10	11	12	13	14	15	16	17	18	19	20
HRc	13	25	28	32	38	10	29	32	38	15	35	15	23	10	10	26	3	25	21	
HB	125	190	250	270	300	180	275	300	350	200	325	200	240	180	180	260	160	250	130	230
Recommend	○	○	○	○	○	○	○	○	○	○	○	◎	◎	◎	○	○	○	○	○	○

ISO Material Description	N					S					H										
	Aluminum-wrought alloy		Aluminum-cast, alloyed			Copper and Copper Alloys (Bronze / Brass)		Non Metallic Materials			Heat Resistant Super Alloys			Titanium Alloys		Hardened steel	Chilled Cast Iron	Hardened Cast Iron			
VDI 3323	21	22	23	24	25	26	27	28	29	30	31	32	33	34	35	36	37	38	39	40	41
HRc	15	30	25	38	34						15	30	25	38	34	55	60	42	55		
HB	60	100	75	90	130	110	90	100			200	280	250	350	320	400 Rm	1050 Rm	550	630	400	550
Recommend	○	○	○	○	○	○	○	○	○	○	○	○	○	○	○	◎	◎	○	○	○	○



PLAIN SHANK **GMG30** SERIES
FLAT SHANK **GMG31** SERIES

CARBIDE, 5 FLUTE CORNER RADIUS LONG LENGTH

- VOLLHARTMETALL, 5 SCHNEIDEN LANG mit ECKRADIUS
- CARBURE, 5 DENTS, TORIQUE, SÉRIE LONGUE
- FRESA IN MD, 5 TAGLIENTI, SERIE LUNGA, TORICA

- ▶ Excellent performance results and long tool life when machining Titanium and other tough materials.
- ▶ This tool has high rigidity of flute so that is possible to use for heavy profile and high speed milling.
- ▶ For protecting Corner chipping of end teeth, Corner Radius & Chamfer are adopted.

- ▶ Exzellente Leistungsergebnisse und hohe Standzeiten beim Bearbeiten von Titan oder anderen robusten Materialien.
- ▶ Die Schneiden des Werkzeugs haben eine besondere Festigkeit, so dass es für schwere Profile und zum High-Speed-Fräsen geeignet ist.
- ▶ Durch die Fase und den Eckradius werden Ausbrüche verhindert.

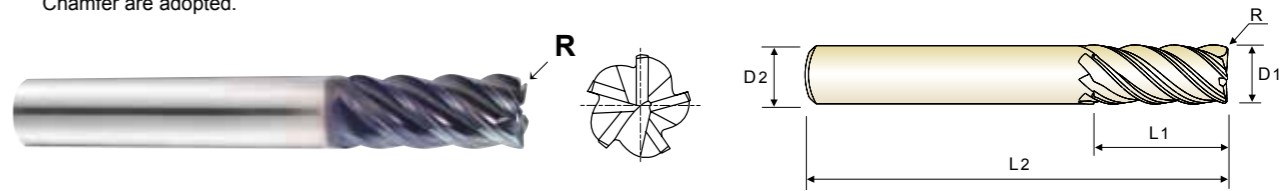

Flat Shank	Page	Plain Shank	Page
END MILL HOLDER	D118-137	POWER MILLING CHUCK	D161-176
-	-	HYDRAULIC CHUCK	D15-46
-	-	SHRINK FIT HOLDER	D47-72
-	-	ER COLLET CHUCK	D73-116

Unit : mm

EDP No.		Corner Radius	Mill Diameter	Shank Diameter	Length of Cut	Overall Length
PLAIN	FLAT	R	D1	D2	L1	L2
GMG30060	GMG31060	R0.3	6.0	6	13	57
GMG30901	GMG31901	R0.5	6.0	6	13	57
GMG30902	GMG31902	R1.0	6.0	6	13	57
GMG30080	GMG31080	R0.5	8.0	8	19	63
GMG30903	GMG31903	R1.0	8.0	8	19	63
GMG30904	GMG31904	R1.5	8.0	8	19	63
GMG30905	GMG31905	R2.0	8.0	8	19	63
GMG30100	GMG31100	R0.5	10.0	10	22	72
GMG30906	GMG31906	R1.0	10.0	10	22	72
GMG30907	GMG31907	R1.5	10.0	10	22	72
GMG30908	GMG31908	R2.0	10.0	10	22	72
GMG30120	GMG31120	R0.5	12.0	12	26	83
GMG30909	GMG31909	R1.0	12.0	12	26	83
GMG30910	GMG31910	R1.5	12.0	12	26	83
GMG30911	GMG31911	R2.0	12.0	12	26	83
GMG30912	GMG31912	R2.5	12.0	12	26	83
GMG30913	GMG31913	R3.0	12.0	12	26	83
GMG30160	GMG31160	R1.0	16.0	16	36	92
GMG30914	GMG31914	R1.5	16.0	16	36	92
GMG30915	GMG31915	R2.0	16.0	16	36	92
GMG30916	GMG31916	R2.5	16.0	16	36	92
GMG30917	GMG31917	R3.0	16.0	16	36	92

Mill Dia. Tolerance (mm)	Shank Dia. Tolerance
0 ~ - 0.03	h5 * Shank Dia. ≥ Ø12 : h6

◎ : Excellent ○ : Good

ISO Material Description	P										M				K					
	Non-alloy steel					Low alloy steel					High alloyed steel, and tool steel		Stainless steel		Grey cast iron	Nodular cast iron		Malleable cast iron		
VDI 3323	1	2	3	4	5	6	7	8	9	10	11	12	13	14	15	16	17	18	19	20
HRc	13	25	28	32	38	10	29	32	38	15	35	15	23	10	10	26	3	25	21	
HB	125	190	250	270	300	180	275	300	350	200	325	200	240	180	180	260	160	250	130	230
Recommend	○	○	○	○	○	○	○	○	○	○	◎	◎	◎	○	○	○	○	○	○	○

ISO Material Description	N					S					H										
	Aluminum-wrought alloy		Aluminum-cast, alloyed			Copper and Copper Alloys (Bronze / Brass)		Non Metallic Materials			Heat Resistant Super Alloys			Titanium Alloys		Hardened steel	Chilled Cast Iron	Hardened Cast Iron			
VDI 3323	21	22	23	24	25	26	27	28	29	30	31	32	33	34	35	36	37	38	39	40	41
HRc	15	30	25	38	34						15	30	25	38	34	55	60	42	55		
HB	60	100	75	90	130	110	90	100			200	280	250	350	320	400 Rm	1050 Rm	550	630	400	550
Recommend	○	○	○	○	○	○	○	○	○	○	○	○	○	○	○	◎	◎	○	○	○	○

CARBIDE, 5 FLUTE CORNER RADIUS LONG LENGTH

- VOLLHARTMETALL, 5 SCHNEIDEN LANG mit ECKRADIUS
- () CARBURE, 5 DENTS, TORIQUE, SÉRIE LONGUE
- () FRESA IN MD, 5 TAGLIENTI, SERIE LUNGA, TORICA

- ▶ Excellent performance results and long tool life when machining Titanium and other tough materials.
- ▶ This tool has high rigidity of flute so that is possible to use for heavy profile and high speed milling.
- ▶ For protecting Corner chipping of end teeth, Corner Radius & Chamfer are adopted.

- ▶ Exzellente Leistungsergebnisse und hohe Standzeiten beim Bearbeiten von Titan oder anderen robusten Materialien.
- ▶ Die Schneiden des Werkzeugs haben eine besondere Festigkeit, so dass es für schwere Profile und zum High-Speed-Fräsen geeignet ist.
- ▶ Durch die Fase und den Eckradius werden Ausbrüche verhindert.

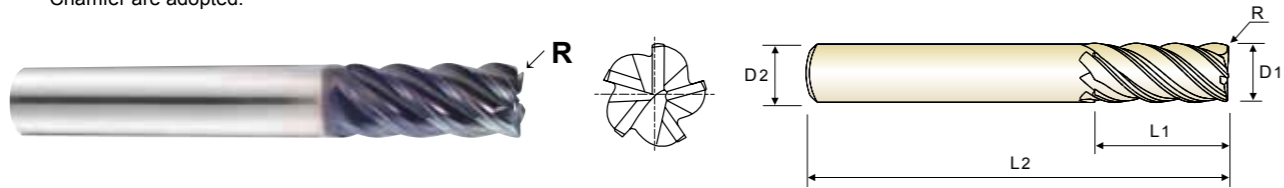

CARBIDE 5 43°/44°/45° PLAIN FLAT Coating Y p.C390

Flat Shank	Page	Plain Shank	Page
END MILL HOLDER	D118-137	POWER MILLING CHUCK	D161-176
-	-	HYDRAULIC CHUCK	D15-46
-	-	SHRINK FIT HOLDER	D47-72
-	-	ER COLLET CHUCK	D73-116

Unit : mm

EDP No.		Corner Radius	Mill Diameter	Shank Diameter	Length of Cut	Overall Length
PLAIN	FLAT	R	D1	D2	L1	L2
GMG30918	GMG31918	R4.0	16.0	16	36	92
GMG30200	GMG31200	R1.0	20.0	20	44	104
GMG30919	GMG31919	R1.5	20.0	20	44	104
GMG30920	GMG31920	R2.0	20.0	20	44	104
GMG30921	GMG31921	R2.5	20.0	20	44	104
GMG30922	GMG31922	R3.0	20.0	20	44	104
GMG30923	GMG31923	R4.0	20.0	20	44	104
GMG30924	GMG31924	R5.0	20.0	20	44	104
GMG30250	GMG31250	R1.0	25.0	25	54	121
GMG30925	GMG31925	R1.5	25.0	25	54	121
GMG30926	GMG31926	R2.0	25.0	25	54	121
GMG30927	GMG31927	R2.5	25.0	25	54	121
GMG30928	GMG31928	R3.0	25.0	25	54	121
GMG30929	GMG31929	R4.0	25.0	25	54	121
GMG30930	GMG31930	R5.0	25.0	25	54	121

Mill Dia. Tolerance (mm)	Shank Dia. Tolerance
0 ~ -0.03	h5 * Shank Dia. ≥ Ø12 : h6

◎ : Excellent ○ : Good

ISO	P									M				K						
Material Description	Non-alloy steel				Low alloy steel					High alloyed steel, and tool steel				Stainless steel				Grey cast iron	Nodular cast iron	Malleable cast iron
VDI 3323	1	2	3	4	5	6	7	8	9	10	11	12	13	14	15	16	17	18	19	20
HRc	13	25	28	32	10	29	32	38	38	15	35	15	23	10	10	26	3	25	21	
HB	125	190	250	270	300	180	275	300	350	200	325	200	240	180	180	260	160	250	130	230
Recommend	○	○	○	○	○	○	○	○	○	○	○	◎	◎	◎	○	○	○	○	○	○

CARBIDE, 5 FLUTE SHORT LENGTH

- VOLLHARTMETALL, 5 SCHNEIDEN KURZ
- () CARBURE, 5 DENTS, SÉRIE COURTE
- () FRESA IN MD, 5 TAGLIENTI, SERIE CORTA

- ▶ Excellent performance results and long tool life when machining Titanium and other tough materials.
- ▶ This tool has high rigidity of flute so that is possible to use for heavy profile and high speed milling.
- ▶ For protecting Corner chipping of end teeth, Corner Radius & Chamfer are adopted.

- ▶ Exzellente Leistungsergebnisse und hohe Standzeiten beim Bearbeiten von Titan oder anderen robusten Materialien.
- ▶ Die Schneiden des Werkzeugs haben eine besondere Festigkeit, so dass es für schwere Profile und zum High-Speed-Fräsen geeignet ist.
- ▶ Durch die Fase und den Eckradius werden Ausbrüche verhindert.

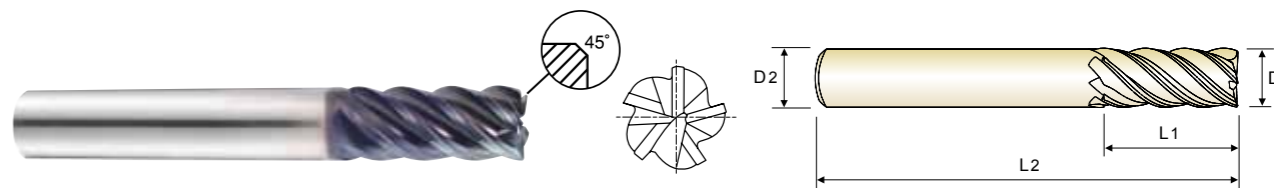

CARBIDE 5 43°/44°/45° PLAIN FLAT C x 45° Coating Y p.C391

Flat Shank	Page	Plain Shank	Page
END MILL HOLDER	D118-137	POWER MILLING CHUCK	D161-176
-	-	HYDRAULIC CHUCK	D15-46
-	-	SHRINK FIT HOLDER	D47-72
-	-	ER COLLET CHUCK	D73-116

Unit : mm

EDP No.		Mill Diameter	Shank Diameter	Length of Cut	Overall Length	Chamfer
PLAIN	FLAT	D1	D2	L1	L2	
GMG24060	GMG25060	6.0	6	10	54	0.20
GMG24080	GMG25080	8.0	8	12	58	0.20
GMG24100	GMG25100	10.0	10	14	66	0.30
GMG24120	GMG25120	12.0	12	16	73	0.35
GMG24160	GMG25160	16.0	16	22	82	0.40
GMG24200	GMG25200	20.0	20	26	92	0.50
GMG24250	GMG25250	25.0	25	29	100	0.50

Mill Dia. Tolerance (mm)	Shank Dia. Tolerance
0 ~ -0.03	h5 * Shank Dia. ≥ Ø12 : h6

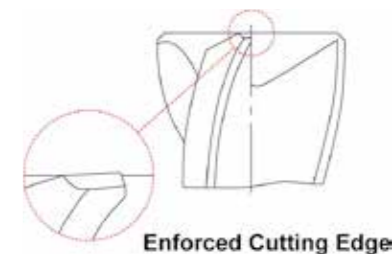

◎ : Excellent ○ : Good

ISO	P									M				K						
Material Description	Non-alloy steel				Low alloy steel					High alloyed steel, and tool steel				Stainless steel				Grey cast iron	Nodular cast iron	Malleable cast iron
VDI 3323	1	2	3	4	5	6	7	8	9	10	11	12	13	14	15	16	17	18	19	20
HRc	13	25	28	32	10	29	32	38	38	15	35	15	23	10	10	26	3	25	21	
HB	125	190	250	270	300	180	275	300	350	200	325	200	240	180	180	260	160	250	130	230
Recommend	○	○	○	○	○	○	○	○	○	○	○	◎	◎	◎	○	○	○	○	○	○

CARBIDE, 5 FLUTE LONG LENGTH

- VOLLHARTMETALL, 5 SCHNEIDEN LANG**
- CARBURE, 5 DENTS, SÉRIE LONGUE**
- FRESA IN MD, 5 TAGLIENTI, SERIE LUNGA**

- Suitable for Titanium, Titanium Alloys, Inconel and Stainless Steels.
- Optimized flute design for chip evacuation and rigidity when machining difficult-to-cut materials.
- Special roughing profile for machining Titanium and Titanium Alloys.
- Longer tool life with special coating.

- Einsetzbar für Titan, Titanlegierungen, Nickellegierungen und rostfreie Stähle.
- Verbessertes Schneidendesign für eine optimale Spanabfuhr und Stabilität beim Bearbeiten von schwer zerspanbaren Materialien.
- Spezielles Schruppprofil zum Bearbeiten von Titan und Titanlegierungen.
- Erhöhte Standzeit durch Spezialbeschichtung.

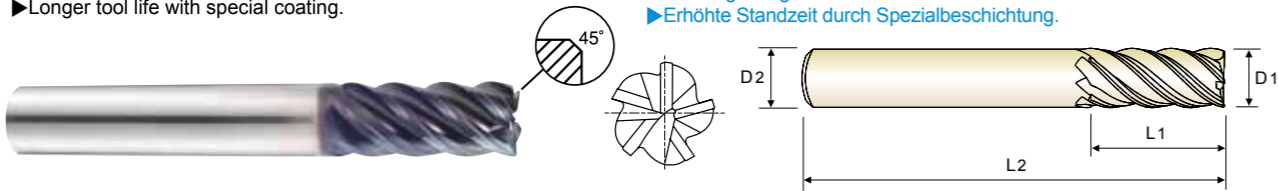

	Flat Shank	Page	Plain Shank	Page
END MILL HOLDER	D118 - 137		POWER MILLING CHUCK	D161 - 176
	-	-	HYDRAULIC CHUCK	D15 - 46
	-	-	SHRINK FIT HOLDER	D47 - 72
	-	-	ER COLLET CHUCK	D73 - 116

Unit : mm

EDP No.	Mill Diameter	Shank Diameter	Length of Cut	Overall Length	Chamfer
GMG26060	6.0	6	13	57	0.20
GMG26080	8.0	8	19	63	0.20
GMG26100	10.0	10	22	72	0.30
GMG26120	12.0	12	26	83	0.35
GMG26160	16.0	16	36	92	0.40
GMG26200	20.0	20	44	104	0.50
GMG26250	25.0	25	54	121	0.50

Mill Dia. Tolerance (mm)	Shank Dia. Tolerance
0 ~ - 0.03	h5 * Shank Dia. ≥ Ø12 : h6

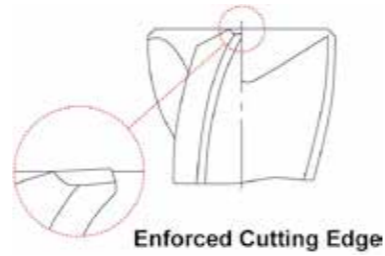

◎ : Excellent ○ : Good

ISO Material Description	P										M			K						
	Non-alloy steel					Low alloy steel					High alloyed steel, and tool steel			Stainless steel			Grey cast iron	Nodular cast iron	Malleable cast iron	
VDI 3323	1	2	3	4	5	6	7	8	9	10	11	12	13	14	15	16	17	18	19	20
HRc	13	25	28	32	38	10	29	32	38	45	15	35	40	48	10	26	3	25	21	21
HB	125	190	250	270	300	180	275	300	350	400	200	240	180	180	180	260	160	250	130	230
Recommend	○	○	○	○	○	○	○	○	○	○	○	◎	◎	◎	○	○	○	○	○	○

ISO Material Description	N					S					H										
	Aluminum-wrought alloy		Aluminum-cast, alloyed			Copper and Copper Alloys (Bronze / Brass)			Non Metallic Materials		Heat Resistant Super Alloys			Titanium Alloys	Hardened steel	Chilled Cast Iron	Hardened Cast Iron				
VDI 3323	21	22	23	24	25	26	27	28	29	30	31	32	33	34	35	36	37	38	39	40	41
HRc	21	22	23	24	25	26	27	28	29	30	31	32	33	34	35	36	37	38	39	40	41
HB	60	100	75	90	130	110	90	100			200	280	250	350	320	400 Rm	1050 Rm	550	630	400	550
Recommend	○	○	○	○	○	○	○	○	○	○	○	○	○	○	○	◎	◎	○	○	○	○

CARBIDE, 5 FLUTE 40° HELIX CORNER RADIUS ROUGHING - FINE

- VOLLHARTMETALL, 5 SCHNEIDEN 40° HELIX mit ECKRADIUS FÜR FEINSCHRUPPEN**
- CARBURE, 5 DENTS, HÉLICE 40°, TORIQUE, ÉBAUCHE PAS FINS**
- FRESA IN MD, 5 TAGLIENTI, ELICA 40°, TORICA, BOMBATO FINE**

- Excellent performance results and long tool life when machining Titanium and other tough materials.
- This tool has high rigidity of flute so that is possible to use for heavy profile and high speed milling.
- For protecting Corner chipping of end teeth, Corner Radius & Chamfer are adopted.

- Exzellente Leistungsergebnisse und hohe Standzeiten beim Bearbeiten von Titan oder anderen robusten Materialien.
- Die Schneiden des Werkzeugs haben eine besondere Festigkeit, so dass es für schwere Profile und zum High-Speed-Fräsen geeignet ist.
- Durch die Fase und den Eckradius werden Ausbrüche verhindert.

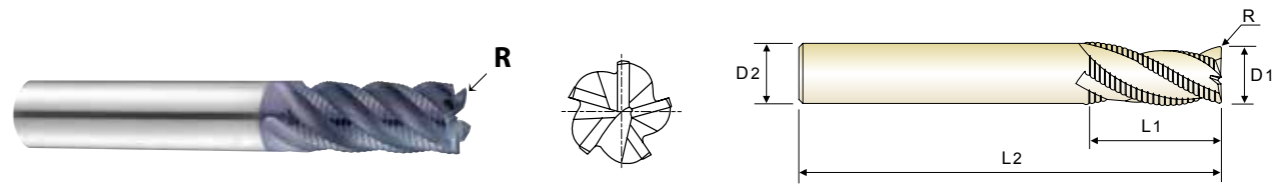

	Flat Shank	Page	Plain Shank	Page
END MILL HOLDER	D118 - 137		POWER MILLING CHUCK	D161 - 176
	-	-	HYDRAULIC CHUCK	D15 - 46
	-	-	SHRINK FIT HOLDER	D47 - 72
	-	-	ER COLLET CHUCK	D73 - 116

Unit : mm

EDP No.	Corner Radius	Mill Diameter	Shank Diameter	Length of Cut	Overall Length	
						PLAIN
EHE54060	R0.2	6.0	6	16	57	
EHE54080	R0.2	8.0	8	16	63	
EHE54100	R0.3	10.0	10	22	72	
EHE54120	R0.3	12.0	12	26	83	
EHE54140	R0.3	14.0	14	26	83	
EHE54160	R0.3	16.0	16	32	92	
EHE54200	R0.3	20.0	20	38	104	
EHE54250	R0.3	25.0	25	45	121	

Tolerances according to DIN 7160 & 7161

	Tolerance range in μ m				
	Nominal-Diameter in mm				
	from 1 to 3	over 3 to 6	over 6 to 10	over 10 to 18	over 18 to 30
h10	0 - 40	0 - 48	0 - 58	0 - 70	0 - 84
h5	0 - 4	0 - 5	0 - 6	0 - 8	0 - 9

* Shank Dia. ≥ Ø12 : h6

◎ : Excellent ○ : Good

ISO Material Description	P										M			K						
	Non-alloy steel					Low alloy steel					High alloyed steel, and tool steel			Stainless steel			Grey cast iron	Nodular cast iron	Malleable cast iron	
VDI 3323	1	2	3	4	5	6	7	8	9	10	11	12	13	14	15	16	17	18	19	20
HRc	13	25	28	32	38	10	29	32	38	45	15	35	40	48	10	26	3	25	21	21
HB	125	190	250	270	300	180	275	300	350	400	200	240	180	180	180	260	160	250	130	230
Recommend	○	○	○	○	○	○	○	○	○	○	○	○	○	○	○	○	○	○	○	○

ISO Material Description	N					S					H										
	Aluminum-wrought alloy		Aluminum-cast, alloyed			Copper and Copper Alloys (Bronze / Brass)			Non Metallic Materials		Heat Resistant Super Alloys			Titanium Alloys	Hardened steel	Chilled Cast Iron	Hardened Cast Iron				
VDI 3323	21	22	23	24	25	26	27	28	29	30	31	32	33	34	35	36	37	38	39	40	41
HRc	21	22	23	24	25	26	27	28	29	30	31	32	33	34	35	36	37	38	39	40	41
HB	60	100	75	90	130	110	90	100			200	280	250	350	320	400 Rm	1050 Rm	550	630	400	550
Recommend	○	○	○	○	○	○	○	○	○	○	○	○	○	○	○	◎	◎	○	○	○	○



RECOMMENDED CUTTING CONDITIONS
EMPFOHLENE SCHNEIDPARAMETER



RECOMMENDED CUTTING CONDITIONS
EMPFOHLENE SCHNEIDPARAMETER

GMG28 GMG29 GMG30 GMG31 5 FLUTE CORNER RADIUS - SIDE CUTTING

Vc = m/min.
fz = mm/tooth
RPM = rev/min.
FEED = mm/min.

GMG24 GMG25 GMG26 GMG27 5 FLUTE - SIDE CUTTING

Vc = m/min.
fz = mm/tooth
RPM = rev/min.
FEED = mm/min.

Table with 18 columns: ISO, VDI 3323, Material Description, Ae, Ap, Parameter, and Diameter (Ø) from 6.0 to 25.0. Rows include materials like Non-alloy steel, Low alloy steel, High alloyed steel, Stainless steel, Grey cast iron, Heat Resistant Super Alloys, and Titanium Alloys.

Table with 18 columns: ISO, VDI 3323, Material Description, Ae, Ap, Parameter, and Diameter (Ø) from 6.0 to 25.0. Rows include materials like Non-alloy steel, Low alloy steel, High alloyed steel, Stainless steel, Grey cast iron, Heat Resistant Super Alloys, and Titanium Alloys.

* Maximum recommended depth shown.
* Finish cuts typically require reduced feed rates and/or higher spindle speed, with radial width of 2% x D1 or less.
* Reduce speed and feed recommendations for materials harder than listed.
* Above recommendations are based on ideal conditions.
Adjust parameters accordingly for smaller taper machining centers or less rigid conditions.

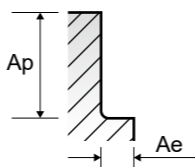

* Maximum recommended depth shown.
* Finish cuts typically require reduced feed rates and/or higher spindle speed, with radial width of 2% x D1 or less.
* Reduce speed and feed recommendations for materials harder than listed.
* Above recommendations are based on ideal conditions.
Adjust parameters accordingly for smaller taper machining centers or less rigid conditions.

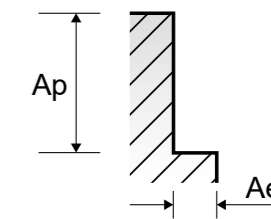

EHE54, EHE55 SERIES 5 FLUTES ROUGHING - SIDE CUTTING

Table with 18 columns: ISO, VDI 3323, Material Description, Ae, Ap, Parameter, and Diameter (Ø) from 6.0 to 25.0. Rows include Stainless steel, Heat Resistant Super Alloys, and Titanium Alloys.



Global Cutting Tool Leader **YG-1**



MILLING



Leading Through Innovation



SOLID CARBIDE

JET-POWER END MILLS

JET - POWER VHM/HSS-PM - FRÄSERFRÄSER

- For Exotic materials like Stainless Steels, Nickel Alloys and Titanium
- Für Sonderwerkstoffe wie rostfreie Stähle, Nickellegierungen und Titan.

SELECTION GUIDE



SOLID CARBIDE
JET-POWER
END MILLS

Exotic materials like Stainless Steels
Nickel alloys and Titanium

Please visit
globalyg1.com/mat
for material search

◎ : Excellent ○ : Good

Recommended cutting conditions : p. C405

SERIES	EH911 EH912	EH913 EH914
FLUTE	2	4
HELIX ANGLE	35°	35°
CUTTING EDGE SHAPE	SQUARE	SQUARE
SIZE MIN	D1.0	D2.0
SIZE MAX	D25.0	D25.0
PAGE	C396	C398
	SHORT LENGTH	SHORT LENGTH
	TiAIN	TiAIN

ISO	VDI 3323	Material Description	Composition / Structure / Heat Treatment	HB	HRc
P	1	Non-alloy steel	About 0.15% C Annealed	125	
	2		About 0.45% C Annealed	190	13
	3		About 0.45% C Quenched & Tempered	250	25
	4		About 0.75% C Annealed	270	28
	5		About 0.75% C Quenched & Tempered	300	32
	6	Low alloy steel	Annealed	180	10
	7		Quenched & Tempered	275	29
	8		Quenched & Tempered	300	32
	9		Quenched & Tempered	350	38
	10	High alloyed steel, and tool steel	Annealed	200	15
	11		Quenched & Tempered	325	35
M	12	Stainless steel	Ferritic / Martensitic Annealed	200	15
	13		Martensitic Quenched & Tempered	240	23
	14		Austenitic	180	10
K	15	Grey cast iron	Pearlitic / ferritic	180	10
	16		Pearlitic (Martensitic)	260	26
	17	Nodular cast iron	Ferritic	160	3
	18		Pearlitic	250	25
	19	Malleable cast iron	Ferritic	130	
20	Pearlitic		230	21	
N	21	Aluminum-wrought alloy	Not Curable	60	
	22		Curable Hardened	100	
	23	Aluminum-cast, alloyed	≤ 12% Si, Not Curable	75	
	24		≤ 12% Si, Curable Hardened	90	
	25		> 12% Si, Not Curable	130	
	26	Copper and Copper Alloys	Cutting Alloys, PB>1%	110	
	27		(Bronze / Brass)	90	
	28	Non Metallic Materials	CuSn, lead-free copper and electrolytic copper	100	
	29		Duroplastic, Fiber Reinforced Plastic		
30	Rubber, Wood, etc.				
S	31	Heat Resistant Super Alloys	Fe Based Annealed	200	15
	32		Cured	280	30
	33		Annealed	250	25
	34		Ni or Co Based Cured	350	38
	35		Cast	320	34
	36	Titanium Alloys	Pure Titanium	400 Rm	
37	Alpha + Beta Alloys Hardened		1050 Rm		
H	38	Hardened steel	Hardened	550	55
	39		Hardened	630	60
	40	Chilled Cast Iron	Cast	400	42
	41	Hardened Cast Iron	Hardened	550	55

EH915 EH916	EH831 EH841	EH917 EH918	EH919 EH920	EH921 EH942
6&8	Multi Flute	Multi Flute	Multi Flute	Multi Flute
45°	30°	45°	45°	45°
SQUARE	ROUGHING	ROUGHING	ROUGHING	ROUGHING
D6.0	D6.0	D6.0	D4.0	D6.0
D25.0	D25.0	D20.0	D25.0	D20.0
C400	C401	C402	C403	C404
LONG LENGTH	LONG LENGTH	SHORT LENGTH	LONG LENGTH	LONG LENGTH
TiAIN	TiAIN	TiAIN	TiAIN	TiAIN



PLAIN SHANK **EH911** SERIES
 FLAT SHANK **EH912** SERIES

CARBIDE, 2 FLUTE 35° HELIX SHORT LENGTH

● VOLLHARTMETALL, 2 SCHNEIDEN 35° RECHTSSPIRALE KURZ
 () Fraise carbure, 2 dents, hélice 35°, courte
 () 2 TAGLIENTI, ELICA 35°, CORTA

- ▶ Ultra micro grain carbide
- ▶ Reduces chipping of corner edges
- ▶ Suitable for low hardness materials (under HRC45), alloy steels, tool steels, carbon steels, prehardened steels, stainless steels, etc

- ▶ Ultra Feinstkorn - Vollhartmetall.
- ▶ Verstärkte Schneidkante.
- ▶ zur Bearbeitung von: Werkstoffen bis 45 HRC, rostfreien Stählen, Titan und Nickellegierungen.

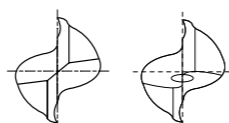

up to Ø3mm over Ø3mm

CARBIDE 2 35° PLAIN FLAT TiAlN p.C405

Flat Shank	Page	Plain Shank	Page
END MILL HOLDER	D118-137	POWER MILLING CHUCK	D161-176
		HYDRAULIC CHUCK	D15-46
		SHRINK FIT HOLDER	D47-72
		ER COLLET CHUCK	D73-116

Unit : mm

EDP No.		Mill Diameter	Shank Diameter	Length of Cut	Overall Length
PLAIN	FLAT	D1	D2	L1	L2
EH911010	-	1.0	4	2.5	40
EH911901	EH912901	1.0	6	2.5	40
EH911015	-	1.5	4	4	40
EH911902	EH912902	1.5	6	4	40
EH911020	-	2.0	4	6	40
EH911903	EH912903	2.0	6	6	40
EH911025	-	2.5	4	8	40
EH911904	EH912904	2.5	6	8	40
EH911030	EH912030	3.0	6	8	45
EH911035	EH912035	3.5	6	10	45
EH911040	EH912040	4.0	6	11	45
EH911045	EH912045	4.5	6	11	45
EH911050	EH912050	5.0	6	13	50
EH911055	EH912055	5.5	6	13	50
EH911060	EH912060	6.0	6	13	50
EH911065	EH912065	6.5	8	16	60
EH911070	EH912070	7.0	8	16	60
EH911075	EH912075	7.5	8	16	60
EH911080	EH912080	8.0	8	19	60
EH911085	EH912085	8.5	10	19	70

Mill Dia. Tolerance (mm)	Shank Dia. Tolerance
0 ~ - 0.03	h5

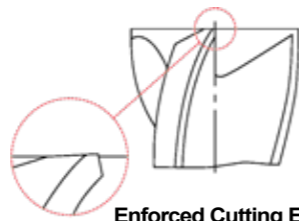

Enforced Cutting Edge

▶ NEXT PAGE

◎ : Excellent ○ : Good

ISO Material Description	P									M						K					
	Non-alloy steel			Low alloy steel			High alloyed steel, and tool steel			Stainless steel			Grey cast iron		Nodular cast iron		Malleable cast iron				
VDI 3323	1	2	3	4	5	6	7	8	9	10	11	12	13	14	15	16	17	18	19	20	
HRc	13	25	28	32	38	10	29	32	38	15	35	15	23	10	10	26	3	25	21		
HB	125	190	250	270	300	180	275	300	350	200	325	200	240	180	180	260	160	250	130	230	
Recommend	○	○	◎	◎	◎	○	◎	◎	◎	◎	○	○	○	◎	◎	◎	◎	◎	◎	◎	

ISO Material Description	N						S						H								
	Aluminum-wrought alloy		Aluminum-cast, alloyed		Copper and Copper Alloys (Bronze / Brass)		Heat Resistant Super Alloys			Titanium Alloys			Hardened steel	Chilled Cast Iron	Hardened Cast Iron						
VDI 3323	21	22	23	24	25	26	27	28	29	30	31	32	33	34	35	36	37	38	39	40	41
HRc	21	22	23	24	25	26	27	28	29	30	31	32	33	34	35	36	37	38	39	40	41
HB	60	100	75	90	130	110	90	100			200	280	250	350	320	400 Rm	1050 Rm	550	630	400	550
Recommend											◎	◎				◎	◎	◎	◎	◎	◎



PLAIN SHANK **EH911** SERIES
 FLAT SHANK **EH912** SERIES

CARBIDE, 2 FLUTE 35° HELIX SHORT LENGTH

● VOLLHARTMETALL, 2 SCHNEIDEN 35° RECHTSSPIRALE KURZ
 () Fraise carbure, 2 dents, hélice 35°, courte
 () 2 TAGLIENTI, ELICA 35°, CORTA

- ▶ Ultra micro grain carbide
- ▶ Reduces chipping of corner edges
- ▶ Suitable for low hardness materials (under HRC45), alloy steels, tool steels, carbon steels, prehardened steels, stainless steels, etc

- ▶ Ultra Feinstkorn - Vollhartmetall.
- ▶ Verstärkte Schneidkante.
- ▶ zur Bearbeitung von: Werkstoffen bis 45 HRC, rostfreien Stählen, Titan und Nickellegierungen.

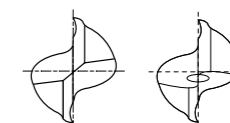

up to Ø3mm over Ø3mm

CARBIDE 2 35° PLAIN FLAT TiAlN p.C405

Flat Shank	Page	Plain Shank	Page
END MILL HOLDER	D118-137	POWER MILLING CHUCK	D161-176
		HYDRAULIC CHUCK	D15-46
		SHRINK FIT HOLDER	D47-72
		ER COLLET CHUCK	D73-116

Unit : mm

EDP No.		Mill Diameter	Shank Diameter	Length of Cut	Overall Length
PLAIN	FLAT	D1	D2	L1	L2
EH911090	EH912090	9.0	10	19	70
EH911095	EH912095	9.5	10	19	70
EH911100	EH912100	10.0	10	22	70
EH911110	EH912110	11.0	12	22	75
EH911120	EH912120	12.0	12	26	75
EH911140	EH912140	14.0	16	26	85
EH911160	EH912160	16.0	16	32	100
EH911180	EH912180	18.0	16	32	100
EH911200	EH912200	20.0	20	38	105
EH911220	EH912220	22.0	20	38	105
EH911250	EH912250	25.0	25	45	120

Mill Dia. Tolerance (mm)	Shank Dia. Tolerance
0 ~ - 0.03	h5

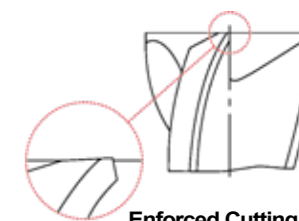

Enforced Cutting Edge

◎ : Excellent ○ : Good

ISO Material Description	P									M						K					
	Non-alloy steel			Low alloy steel			High alloyed steel, and tool steel			Stainless steel			Grey cast iron		Nodular cast iron		Malleable cast iron				
VDI 3323	1	2	3	4	5	6	7	8	9	10	11	12	13	14	15	16	17	18	19	20	
HRc	13	25	28	32	38	10	29	32	38	15	35	15	23	10	10	26	3	25	21		
HB	125	190	250	270	300	180	275	300	350	200	325	200	240	180	180	260	160	250	130	230	
Recommend	○	○	◎	◎	◎	○	◎	◎	◎	◎	○	○	○	◎	◎	◎	◎	◎	◎	◎	

ISO Material Description	N						S						H								
	Aluminum-wrought alloy		Aluminum-cast, alloyed		Copper and Copper Alloys (Bronze / Brass)		Heat Resistant Super Alloys			Titanium Alloys			Hardened steel	Chilled Cast Iron	Hardened Cast Iron						
VDI 3323	21	22	23	24	25	26	27	28	29	30	31	32	33	34	35	36	37	38	39	40	41
HRc	21	22	23	24	25	26	27	28	29	30	31	32	33	34	35	36	37	38	39	40	41
HB	60	100	75	90	130	110	90	100			200	280	250	350	320	400 Rm	1050 Rm	550	630	400	550
Recommend											◎	◎				◎	◎	◎	◎	◎	◎

CARBIDE, 4 FLUTE 35° HELIX SHORT LENGTH

● **VOLLHARTMETALL, 4 SCHNEIDEN 35° RECHTSSPIRALE KURZ**
 (●) **Fraise carbure, 4 dents, hélice 35°, courte**
 (●) **4 TAGLIENTI, ELICA 35°, CORTA**

- ▶ Ultra micro grain carbide
- ▶ Reduces chipping of corner edges
- ▶ Suitable for low hardness materials (under HRC45), alloy steels, tool steels, carbon steels, prehardened steels, stainless steels, etc

- ▶ Ultra Feinstkorn - Vollhartmetall
- ▶ Verstärkte Schneidkante.
- ▶ Für die Bearbeitung von: Werkstoffen bis 45 HRC, rostfreien Stählen, Titan und Nickellegierungen.

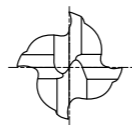

CARBIDE 4 35° PLAIN FLAT TiAIN p.C406

Flat Shank	Page	Plain Shank	Page
END MILL HOLDER	D118-137	POWER MILLING CHUCK	D161-176
-	-	HYDRAULIC CHUCK	D15-46
-	-	SHRINK FIT HOLDER	D47-72
-	-	ER COLLET CHUCK	D73-116

Unit : mm

EDP No.		Mill Diameter	Shank Diameter	Length of Cut	Overall Length
PLAIN	FLAT	D1	D2	L1	L2
EH913020	-	2.0	4	6	40
EH913901	EH914901	2.0	6	6	40
EH913025	-	2.5	4	8	40
EH913902	EH914902	2.5	6	8	40
EH913030	EH914030	3.0	6	8	45
EH913035	EH914035	3.5	6	10	45
EH913040	EH914040	4.0	6	11	45
EH913045	EH914045	4.5	6	11	45
EH913050	EH914050	5.0	6	13	50
EH913055	EH914055	5.5	6	13	50
EH913060	EH914060	6.0	6	13	50
EH913065	EH914065	6.5	8	16	60
EH913070	EH914070	7.0	8	16	60
EH913075	EH914075	7.5	8	16	60
EH913080	EH914080	8.0	8	19	60
EH913085	EH914085	8.5	10	19	70
EH913090	EH914090	9.0	10	19	70
EH913095	EH914095	9.5	10	19	70
EH913100	EH914100	10.0	10	22	70
EH913110	EH914110	11.0	12	22	75

Mill Dia. Tolerance (mm)	Shank Dia. Tolerance
0 ~ - 0.03	h5

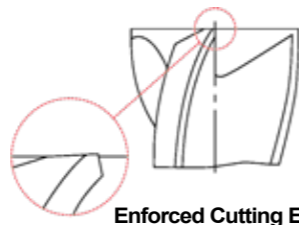

Enforced Cutting Edge

◎ : Excellent ○ : Good

ISO Material Description	P									M						K					
	Non-alloy steel			Low alloy steel			High alloyed steel, and tool steel			Stainless steel			Grey cast iron		Nodular cast iron		Malleable cast iron				
VDI 3323	1	2	3	4	5	6	7	8	9	10	11	12	13	14	15	16	17	18	19	20	
HRc	13	25	28	32	38	10	29	32	38	15	35	15	23	10	10	26	3	25	21	21	
HB	125	190	250	270	300	180	275	300	350	200	325	200	240	180	180	260	160	250	130	230	
Recommend	○	○	◎	◎	◎	○	◎	◎	◎	◎	◎	○	○	◎	○	◎	◎	◎	◎	◎	◎

ISO Material Description	N						S						H									
	Aluminum-wrought alloy		Aluminum-cast, alloyed		Copper and Copper Alloys (Bronze / Brass)		Heat Resistant Super Alloys			Titanium Alloys			Hardened steel	Chilled Cast Iron	Hardened Cast Iron							
VDI 3323	21	22	23	24	25	26	27	28	29	30	31	32	33	34	35	36	37	38	39	40	41	
HRc	21	22	23	24	25	26	27	28	29	30	15	30	25	38	34	55	60	42	55	42	55	
HB	60	100	75	90	130	110	90	100			200	280	250	350	320	400 Rm	1050 Rm	550	630	400	550	
Recommend	◎	◎	◎	◎	◎	◎	◎	◎	◎	◎	◎	◎	◎	◎	◎	◎	◎	◎	◎	◎	◎	○

CARBIDE, 4 FLUTE 35° HELIX SHORT LENGTH

● **VOLLHARTMETALL, 4 SCHNEIDEN 35° RECHTSSPIRALE KURZ**
 (●) **Fraise carbure, 4 dents, hélice 35°, courte**
 (●) **4 TAGLIENTI, ELICA 35°, CORTA**

- ▶ Ultra micro grain carbide
- ▶ Reduces chipping of corner edges
- ▶ Suitable for low hardness materials (under HRC45), alloy steels, tool steels, carbon steels, prehardened steels, stainless steels, etc

- ▶ Ultra Feinstkorn - Vollhartmetall
- ▶ Verstärkte Schneidkante.
- ▶ Für die Bearbeitung von: Werkstoffen bis 45 HRC, rostfreien Stählen, Titan und Nickellegierungen.

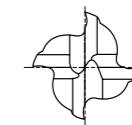

CARBIDE 4 35° PLAIN FLAT TiAIN p.C406

Flat Shank	Page	Plain Shank	Page
END MILL HOLDER	D118-137	POWER MILLING CHUCK	D161-176
-	-	HYDRAULIC CHUCK	D15-46
-	-	SHRINK FIT HOLDER	D47-72
-	-	ER COLLET CHUCK	D73-116

Unit : mm

EDP No.		Mill Diameter	Shank Diameter	Length of Cut	Overall Length
PLAIN	FLAT	D1	D2	L1	L2
EH913120	EH914120	12.0	12	26	75
EH913140	EH914140	14.0	16	26	85
EH913160	EH914160	16.0	16	32	100
EH913180	EH914180	18.0	16	32	100
EH913200	EH914200	20.0	20	38	105
EH913220	EH914220	22.0	20	38	105
EH913250	EH914250	25.0	25	45	120

Mill Dia. Tolerance (mm)	Shank Dia. Tolerance
0 ~ - 0.03	h5

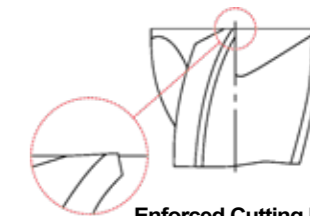

Enforced Cutting Edge

◎ : Excellent ○ : Good

ISO Material Description	P									M						K					
	Non-alloy steel			Low alloy steel			High alloyed steel, and tool steel			Stainless steel			Grey cast iron		Nodular cast iron		Malleable cast iron				
VDI 3323	1	2	3	4	5	6	7	8	9	10	11	12	13	14	15	16	17	18	19	20	
HRc	13	25	28	32	38	10	29	32	38	15	35	15	23	10	10	26	3	25	21	21	
HB	125	190	250	270	300	180	275	300	350	200	325	200	240	180	180	260	160	250	130	230	
Recommend	○	○	◎	◎	◎	○	◎	◎	◎	◎	◎	○	○	◎	○	◎	◎	◎	◎	◎	◎

ISO Material Description	N						S						H									
	Aluminum-wrought alloy		Aluminum-cast, alloyed		Copper and Copper Alloys (Bronze / Brass)		Heat Resistant Super Alloys			Titanium Alloys			Hardened steel	Chilled Cast Iron	Hardened Cast Iron							
VDI 3323	21	22	23	24	25	26	27	28	29	30	31	32	33	34	35	36	37	38	39	40	41	
HRc	21	22	23	24	25	26	27	28	29	30	15	30	25	38	34	55	60	42	55	42	55	
HB	60	100	75	90	130	110	90	100			200	280	250	350	320	400 Rm	1050 Rm	550	630	400	550	
Recommend	◎	◎	◎	◎	◎	◎	◎	◎	◎	◎	◎	◎	◎	◎	◎	◎	◎	◎	◎	◎	◎	○

CARBIDE, 6&8 FLUTE 45° HELIX LONG LENGTH (Positive Rake Angle)

- VOLLHARTMETALL, 6&8 SCHNEIDEN 45° RECHTSSPIRALE LANG
- Fraise carbure, 6&8 dents, hélice 45°, longue (Angle de coupe positif)
- 6&8 TAGLIENTI, ELICA 45°, LUNGA (Tagliente positivizzato)

- ▶ Ultra micro grain carbide
- ▶ Reduces chipping of corner edges
- ▶ Suitable for low hardness materials(under HRC45), alloy steels, tool steels, carbon steels, prehardened steels, stainless steels, etc
- ▶ Ultra Feinstkorn - Vollhartmetall
- ▶ Verstärkte Schneidkante.
- ▶ zur Bearbeitung von: Werkstoffen bis 45 HRc, rostfreien Stählen, Titan und Nickellegierungen.



CARBIDE 6&8 45° PLAIN FLAT TiAIN p.C407

Flat Shank	Page	Plain Shank	Page
END MILL HOLDER	D118-137	POWER MILLING CHUCK	D161-176
-	-	HYDRAULIC CHUCK	D15-46
-	-	SHRINK FIT HOLDER	D47-72
-	-	ER COLLET CHUCK	D73-116

Unit : mm

EDP No.	Mill Diameter	Shank Diameter	Length of Cut	Overall Length	No. of Flute
EH915060	6.0	6	13	57	6
EH915070	7.0	8	16	63	6
EH915080	8.0	8	19	63	6
EH915090	9.0	10	19	72	6
EH915100	10.0	10	22	72	6
EH915120	12.0	12	26	83	6
EH915140	14.0	14	26	83	6
EH915160	16.0	16	32	92	6
EH915180	18.0	18	32	92	8
EH915200	20.0	20	38	104	8
EH915250	25.0	25	44	104	8

Mill Dia. Tolerance (mm)	Shank Dia. Tolerance
0 ~ -0.03	h5

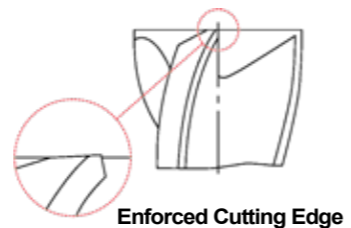

◎ : Excellent ○ : Good

ISO Material Description	P										M				K					
	Non-alloy steel					Low alloy steel					High alloyed steel, and tool steel				Stainless steel		Grey cast iron	Nodular cast iron		Malleable cast iron
VDI 3323	1	2	3	4	5	6	7	8	9	10	11	12	13	14	15	16	17	18	19	20
HRc	13	25	28	32	38	10	29	32	38	45	15	35	40	48	10	26	3	25	21	21
HB	125	190	250	270	300	180	275	300	350	400	200	240	180	180	180	260	160	250	130	230
Recommend	○	○	◎	◎	◎	○	◎	◎	◎	◎	○	○	○	◎	○	○	○	○	○	○

ISO Material Description	N					S					H										
	Aluminum-wrought alloy		Aluminum-cast, alloyed			Copper and Copper Alloys (Bronze / Brass)			Non Metallic Materials		Heat Resistant Super Alloys					Titanium Alloys		Hardened steel	Chilled Cast Iron	Hardened Cast Iron	
VDI 3323	21	22	23	24	25	26	27	28	29	30	31	32	33	34	35	36	37	38	39	40	41
HRc	21	22	23	24	25	26	27	28	29	30	31	32	33	34	35	36	37	38	39	40	41
HB	60	100	75	90	130	110	90	100			200	280	250	350	320	400 Rm	1050 Rm	550	630	400	550
Recommend	○	○	○	○	○	○	○	○	○	○	○	○	○	○	○	◎	◎	○	○	○	○

CARBIDE, MULTI FLUTE LONG LENGTH ROUGHING - FINE

- VOLLHARTMETALL, MULTI SCHNEIDEN LANG SCHRUPPFRÄSER - FEIN
- Fraise carbure, multi-dents ébauche, pas fin, longue
- 3 - 4 - 5 TAGLIENTI, PER SGROSSATURA, LUNGA - Bombato fine

- ▶ Suitable for low hardness materials(under HRC45), alloy steels, tool steels, carbon steels, prehardened steels, stainless steels, etc.
- ▶ High velocity milling operation.
- ▶ Fast chip ejection.
- ▶ zur Bearbeitung von: Werkstoffen bis 45 HRc, rostfreien Stählen, Titan und Nickellegierungen..
- ▶ Hochgeschwindigkeitsfräsen.
- ▶ Schnelle Spanausfuhr.

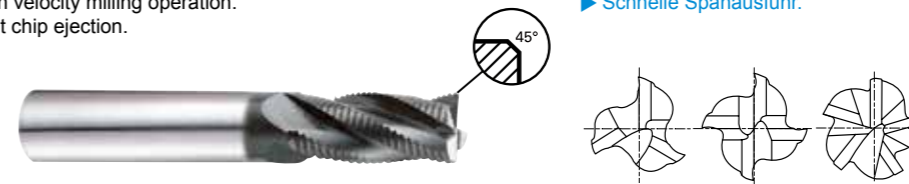

CARBIDE HR 3-5 30°

Flat Shank	Page	Plain Shank	Page
END MILL HOLDER	D118-137	POWER MILLING CHUCK	D161-176
-	-	HYDRAULIC CHUCK	D15-46
-	-	SHRINK FIT HOLDER	D47-72
-	-	ER COLLET CHUCK	D73-116

Unit : mm

EDP No.	Mill Diameter	Shank Diameter	Length of Cut	Overall Length	No. of Flute	Chamfer
EH831060	6.0	6	16	57	3	0.38
EH831070	7.0	8	16	63	3	0.38
EH831080	8.0	8	16	63	3	0.38
EH831090	9.0	10	19	72	4	0.38
EH831100	10.0	10	22	72	4	0.38
EH831120	12.0	12	26	83	4	0.55
EH831140	14.0	14	26	83	4	0.55
EH831160	16.0	16	32	92	4	0.55
EH831180	18.0	18	32	92	4	0.55
EH831200	20.0	20	38	104	4	0.55
EH831250	25.0	25	45	121	5	0.55

Tolerances according to DIN 7160 & 7161

	Tolerance range in μm				
	Nominal-Diameter in mm				
	from 1 to 3	over 3 to 6	over 6 to 10	over 10 to 18	over 18 to 30
h10	0 -40	0 -48	0 -58	0 -70	0 -84
h5	0 -4	0 -5	0 -6	0 -8	0 -9

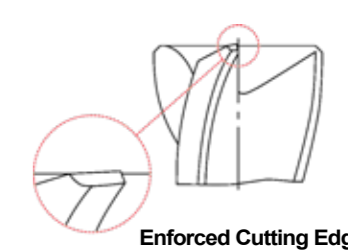

◎ : Excellent ○ : Good

ISO Material Description	P										M				K					
	Non-alloy steel					Low alloy steel					High alloyed steel, and tool steel				Stainless steel		Grey cast iron	Nodular cast iron		Malleable cast iron
VDI 3323	1	2	3	4	5	6	7	8	9	10	11	12	13	14	15	16	17	18	19	20
HRc	13	25	28	32	38	10	29	32	38	45	15	35	40	48	10	26	3	25	21	21
HB	125	190	250	270	300	180	275	300	350	400	200	240	180	180	180	260	160	250	130	230
Recommend	○	○	◎	◎	◎	○	◎	◎	◎	◎	○	○	○	◎	○	○	○	○	○	○

ISO Material Description	N					S					H										
	Aluminum-wrought alloy		Aluminum-cast, alloyed			Copper and Copper Alloys (Bronze / Brass)			Non Metallic Materials		Heat Resistant Super Alloys					Titanium Alloys		Hardened steel	Chilled Cast Iron	Hardened Cast Iron	
VDI 3323	21	22	23	24	25	26	27	28	29	30	31	32	33	34	35	36	37	38	39	40	41
HRc	21	22	23	24	25	26	27	28	29	30	31	32	33	34	35	36	37	38	39	40	41
HB	60	100	75	90	130	110	90	100			200	280	250	350	320	400 Rm	1050 Rm	550	630	400	550
Recommend	○	○	○	○	○	○	○	○	○	○	○	○	○	○	○	◎	◎	○	○	○	○



PLAIN SHANK **EH917** SERIES
FLAT SHANK **EH918** SERIES



PLAIN SHANK **EH919** SERIES
FLAT SHANK **EH920** SERIES

CARBIDE, MULTI FLUTE 45° HELIX SHORT LENGTH ROUGHING - FINE

● **VOLLHARTMETALL, MULTI SCHNEIDEN 45° RECHTSSPIRALE KURZ SCHRUPPFRÄSER - FEIN**
● **Fraise carbure, multi-dents ébauche, hélice 45°, pas fin, courte**
● **4 - 5 - 6 TAGLIENTI, ELICA 45°, PER SGROSSATURA, CORTA - Bombato fine**

- ▶ Ultra micro grain carbide
- ▶ High chip removal and minimizing breakages of cutting edges.
- ▶ Suitable for low hardness materials(under HRC45), alloy steels, tool steels, carbon steels, prehardened steels, stainless steels, etc

- ▶ Ultra Feinstkorn - Vollhartmetall
- ▶ Schnelle Spanausfuhr und Minimierung von Abbrechen von Schneidkanten.
- ▶ zur Bearbeitung von: Werkstoffen bis 45 HRc, rostfreien Stählen, Titan und Nickellegierungen.



CARBIDE HR 4+6 45°
PLAIN FLAT C x 45° TiAIN p.C410-411

Flat Shank		Plain Shank	
END MILL HOLDER	Page	POWER MILLING CHUCK	Page
⊙	D118-137	HYDRAULIC CHUCK	D15-46
○	-	SHRINK FIT HOLDER	D47-72
○	-	ER COLLET CHUCK	D73-116

Unit : mm

EDP No.	Mill Diameter	Shank Diameter	Length of Cut	Overall Length	No. of Flute	Chamfer	
							PLAIN
EH917060	EH918060	6.0	6	7	54	4	0.15
EH917080	EH918080	8.0	8	9	58	4	0.18
EH917100	EH918100	10.0	10	14	66	4	0.20
EH917120	EH918120	12.0	12	16	73	4	0.20
EH917160	EH918160	16.0	16	22	82	5	0.20
EH917200	EH918200	20.0	20	26	92	6	0.20

Tolerances according to DIN 7160 & 7161

Tolerance range in μm					
Nominal-Diameter in mm					
	from 1 to 3	over 3 to 6	over 6 to 10	over 10 to 18	over 18 to 30
h10	0 -40	0 -48	0 -58	0 -70	0 -84
h5	0 -4	0 -5	0 -6	0 -8	0 -9

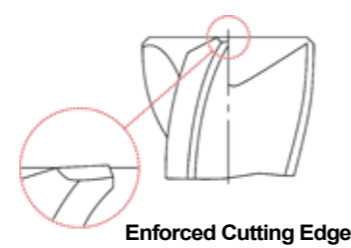

Enforced Cutting Edge

⊙ : Excellent ○ : Good

ISO Material Description	P									M						K					
	Non-alloy steel			Low alloy steel			High alloyed steel, and tool steel			Stainless steel			Grey cast iron		Nodular cast iron		Malleable cast iron				
VDI 3323	1	2	3	4	5	6	7	8	9	10	11	12	13	14	15	16	17	18	19	20	
HRC	13	25	28	32	35	38	42	45	48	52	56	60	64	68	72	76	80	84	88	92	
HB	125	190	250	270	300	180	275	300	350	200	325	200	240	180	160	250	130	230			
Recommend	○	○	⊙	⊙	⊙	○	⊙	⊙	⊙	○	⊙	○	⊙	⊙							

CARBIDE, MULTI FLUTE 45° HELIX LONG LENGTH ROUGHING - FINE

● **VOLLHARTMETALL, MULTI SCHNEIDEN 45° RECHTSSPIRALE LANG SCHRUPPFRÄSER - FEIN**
● **Fraise carbure, multi-dents ébauche, hélice 45°, pas fin, longue**
● **MULTITAGLIENTI, ELICA 45°, PER SGROSSATURA, LUNGA - Bombato fine**

- ▶ Ultra micro grain carbide
- ▶ High chip removal and minimizing breakages of cutting edges.
- ▶ Suitable for low hardness materials(under HRC45), alloy steels, tool steels, carbon steels, prehardened steels, stainless steels, etc

- ▶ Ultra Feinstkorn - Vollhartmetall
- ▶ Schnelle Spanausfuhr und Minimierung von Abbrechen von Schneidkanten.
- ▶ zur Bearbeitung von: Werkstoffen bis 45 HRc, rostfreien Stählen, Titan und Nickellegierungen.

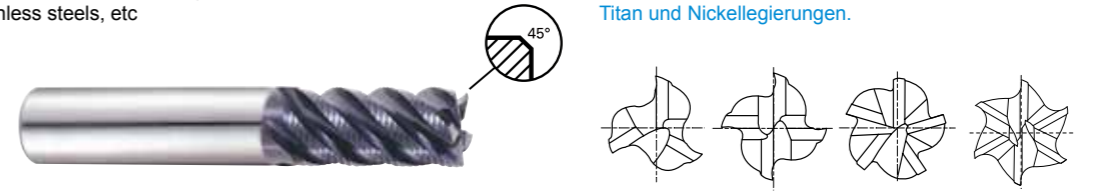

CARBIDE HR 3-6 45°
PLAIN FLAT C x 45° TiAIN p.C412-413

Flat Shank		Plain Shank	
END MILL HOLDER	Page	POWER MILLING CHUCK	Page
⊙	D118-137	HYDRAULIC CHUCK	D15-46
○	-	SHRINK FIT HOLDER	D47-72
○	-	ER COLLET CHUCK	D73-116

Unit : mm

EDP No.	Mill Diameter	Shank Diameter	Length of Cut	Overall Length	No. of Flute	Chamfer	
							PLAIN
EH919040	EH920040	4.0	6	11	57	3	0.1
EH919050	EH920050	5.0	6	13	57	4	0.13
EH919060	EH920060	6.0	6	16	57	4	0.15
EH919070	EH920070	7.0	8	16	63	4	0.15
EH919080	EH920080	8.0	8	16	63	4	0.18
EH919090	EH920090	9.0	10	19	72	4	0.18
EH919100	EH920100	10.0	10	22	72	4	0.2
EH919120	EH920120	12.0	12	26	83	4	0.2
EH919140	EH920140	14.0	14	26	83	5	0.2
EH919160	EH920160	16.0	16	32	92	5	0.2
EH919200	EH920200	20.0	20	38	104	6	0.2
EH919250	EH920250	25.0	25	45	121	6	0.2

Tolerances according to DIN 7160 & 7161

Tolerance range in μm					
Nominal-Diameter in mm					
	from 1 to 3	over 3 to 6	over 6 to 10	over 10 to 18	over 18 to 30
h10	0 -40	0 -48	0 -58	0 -70	0 -84
h5	0 -4	0 -5	0 -6	0 -8	0 -9

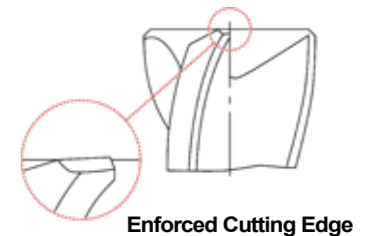

Enforced Cutting Edge

⊙ : Excellent ○ : Good

ISO Material Description	P									M						K					
	Non-alloy steel			Low alloy steel			High alloyed steel, and tool steel			Stainless steel			Grey cast iron		Nodular cast iron		Malleable cast iron				
VDI 3323	1	2	3	4	5	6	7	8	9	10	11	12	13	14	15	16	17	18	19	20	
HRC	13	25	28	32	35	38	42	45	48	52	56	60	64	68	72	76	80	84	88	92	
HB	125	190	250	270	300	180	275	300	350	200	325	200	240	180	160	250	130	230			
Recommend	○	○	⊙	⊙	⊙	○	⊙	⊙	⊙	○	⊙	○	⊙	⊙							



PLAIN SHANK EH921 SERIES
FLAT SHANK EH942 SERIES

CARBIDE, MULTI FLUTE 45° HELIX LONG REACH ROUGHING - FINE

VOLLHARTMETALL, MULTI SCHNEIDEN 45° RECHTSSPIRALE GROßE REICHWEITE SCHRUPPFÄßER - FEIN
Fraise carbure, multi-dents ébauche longue portée, hélice 45°, pas fin
MULTITAGLIENTI, ELICA 45° SCARICATA, PER SGROSSATURA, LUNGA - Bombato fine

Ultra micro grain carbide
High chip removal and minimizing breakages of cutting edges.
Suitable for low hardness materials(under HRC45), alloy steels, tool steels, carbon steels, prehardened steels, stainless steels, etc

Ultra Feinstkorn - Vollhartmetall
Schnelle Spanausfuhr und Minimierung von Abbrechen von Schneidkanten.
zur Bearbeitung von: Werkstoffen bis 45 HRC, rostfreien Stählen, Titan und Nickellegierungen.

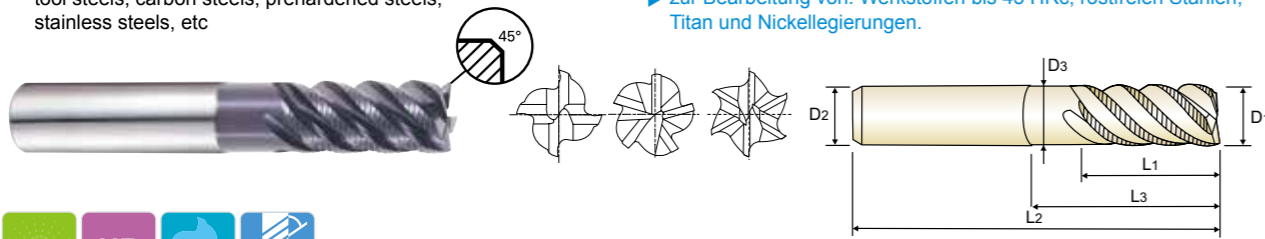

Recommended Tool/Holder table with columns for Flat Shank and Plain Shank, listing various holders and their page references.

Main technical specifications table with columns for EDP No., Mill Diameter, Shank Diameter, Length of Cut, Length Below Shank, Overall Length, Neck Diameter, No. of Flute, and Chamfer.

Tolerances according to DIN 7160 & 7161

Tolerance range table showing values for h10 and h5 across different nominal diameter ranges.

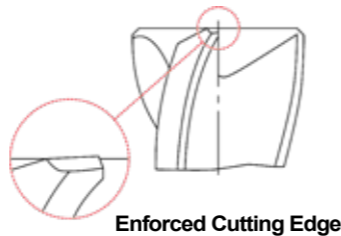

Material selection chart showing ISO standards and material groups for different series (P, M, S, H) and their recommended uses.



EH911, EH912 SERIES 2 FLUTE - SLOTTING

RECOMMENDED CUTTING CONDITIONS EMPFOHLENE SCHNEIDPARAMETER

Large table of recommended cutting conditions (Vc, fz, RPM, FEED) for various materials (Non-alloy steel, Low alloy steel, High alloyed steel, Stainless steel, Titanium Alloys, Chilled Cast Iron) across different diameter ranges.

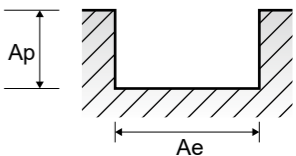



RECOMMENDED CUTTING CONDITIONS
EMPFOHLENE SCHNEIDPARAMETER



RECOMMENDED CUTTING CONDITIONS
EMPFOHLENE SCHNEIDPARAMETER

EH913, EH914 SERIES 4 FLUTE - SIDE CUTTING

Vc = m/min.
fz = mm/tooth
RPM = rev./min.
FEED = mm/min.

Table with columns for ISO, VDI 3323, Material Description, Ae, Ap, Parameter, and Diameter (Ø) from 2.0 to 25.0. Rows include Non-alloy steel, Low alloy steel, High alloyed steel, Stainless steel, Titanium Alloys, and Chilled Cast Iron.

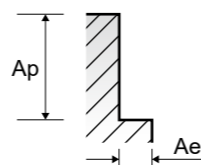

EH915, EH916 SERIES 6&8 FLUTE - SIDE CUTTING

Vc = m/min.
fz = mm/tooth
RPM = rev./min.
FEED = mm/min.

NORMAL SPEED

Table with columns for ISO, VDI 3323, Material Description, Ae, Ap, Parameter, and Diameter (Ø) from 6.0 to 25.0. Rows include Non-alloy steel, Low alloy steel, High alloyed steel, Stainless steel, Heat Resistant Super Alloys, Titanium Alloys, and Chilled Cast Iron.

HIGH SPEED

Table with columns for ISO, VDI 3323, Material Description, Ae, Ap, Parameter, and Diameter (Ø) from 6.0 to 25.0. Rows include Non-alloy steel, Low alloy steel, High alloyed steel, and Chilled Cast Iron.

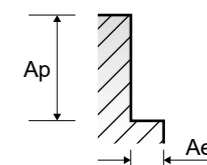

EH917 EH918 | EH921 EH942 MULTI FLUTES ROUGHING - **SLOTING**

Vc = m/min.
fz = mm/tooth
RPM = rev./min.
FEED = mm/min.

ISO	VDI 3323	Material Description	Ae	Ap	Parameter	Diameter (Ø)						
						6.0	8.0	10.0	12.0	16.0	20.0	
P	1-4	Non-alloy steel	1.0D	0.5D	Vc	294	292	289	302	302	302	
					fz	0.022	0.03	0.038	0.045	0.048	0.045	
					RPM	15597	11618	9199	8011	6008	4806	
					FEED	1373	1394	1398	1442	1442	1298	
	5		Vc	234	231	239	226	241	226			
			fz	0.01	0.014	0.016	0.02	0.019	0.016			
			RPM	12414	9191	7608	5995	4795	3597			
			FEED	497	515	487	480	455	345			
	6-7	Vc	294	292	289	302	302	302				
		fz	0.022	0.03	0.038	0.045	0.048	0.045				
		RPM	15597	11618	9199	8011	6008	4806				
		FEED	1373	1394	1398	1442	1442	1298				
8-9	Vc	234	231	239	226	241	226					
	fz	0.01	0.014	0.016	0.02	0.019	0.016					
	RPM	12414	9191	7608	5995	4795	3597					
	FEED	497	515	487	480	455	345					
10	Vc	294	292	289	302	302	302					
	fz	0.022	0.03	0.038	0.045	0.048	0.045					
	RPM	15597	11618	9199	8011	6008	4806					
	FEED	1373	1394	1398	1442	1442	1298					
11.1 11.2	Vc	234	231	239	226	241	226					
	fz	0.01	0.014	0.016	0.02	0.019	0.016					
M	14.1	Stainless steel	1.0D	0.4~10:0.25D 0.12~16:0.15D 0.18~25:0.10D	Vc	158	158	160	158	166	151	
					fz	0.01	0.013	0.017	0.02	0.019	0.015	
					RPM	8382	6287	5093	4191	3302	2403	
					FEED	335	327	346	335	314	216	
S	31-35	Heat Resistant Super Alloys	1.0D	0.5D	Vc	45	45	41	45	40	41	
					fz	0.012	0.015	0.022	0.024	0.016	0.015	
					RPM	2387	1790	1305	1194	796	653	
					FEED	115	107	115	115	64	59	
	36-37	Titanium Alloys	1.0D	0.4~10:0.25D 0.12~16:0.15D 0.18~25:0.10D	Vc	158	158	160	158	166	151	
					fz	0.01	0.013	0.017	0.02	0.019	0.015	
					RPM	8382	6287	5093	4191	3302	2403	
					FEED	335	327	346	335	314	216	
	H	40	Chilled Cast Iron	1.0D	0.5D	Vc	234	231	239	226	241	226
						fz	0.01	0.014	0.016	0.02	0.019	0.016
						RPM	12414	9191	7608	5995	4795	3597
						FEED	372	386	487	480	455	345

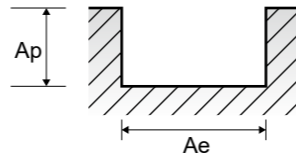

EH917 EH918 | EH921 EH942 MULTI FLUTES ROUGHING - **SIDE CUTTING**

Vc = m/min.
fz = mm/tooth
RPM = rev./min.
FEED = mm/min.

ISO	VDI 3323	Material Description	Ae	Ap	Parameter	Diameter (Ø)						
						6.0	8.0	10.0	12.0	16.0	20.0	
P	1-4	Non-alloy steel	0.3D	1.5D	Vc	294	292	289	302	302	302	
					fz	0.037	0.05	0.063	0.075	0.08	0.075	
					RPM	15597	11618	9199	8011	6008	4806	
					FEED	2308	2324	2318	2403	2403	2163	
	5		Vc	234	231	239	226	241	226			
			fz	0.017	0.023	0.028	0.033	0.032	0.026			
			RPM	12414	9191	7608	5995	4795	3597			
			FEED	844	846	852	791	767	561			
	6-7	Vc	294	292	289	302	302	302				
		fz	0.037	0.05	0.063	0.075	0.08	0.075				
		RPM	15597	11618	9199	8011	6008	4806				
		FEED	2308	2324	2318	2403	2403	2163				
8-9	Vc	234	231	239	226	241	226					
	fz	0.017	0.023	0.028	0.033	0.032	0.026					
	RPM	12414	9191	7608	5995	4795	3597					
	FEED	844	846	852	791	767	561					
10	Vc	294	292	289	302	302	302					
	fz	0.037	0.05	0.063	0.075	0.08	0.075					
	RPM	15597	11618	9199	8011	6008	4806					
	FEED	2308	2324	2318	2403	2403	2163					
11.1 11.2	Vc	234	231	239	226	241	226					
	fz	0.017	0.023	0.028	0.033	0.032	0.026					
M	14.1	Stainless steel	0.4~10:0.15D 0.12~16:0.10D 0.18~25:0.05D	1.5D	Vc	158	158	160	158	166	151	
					fz	0.017	0.023	0.028	0.034	0.031	0.025	
					RPM	8382	6287	5093	4191	3302	2403	
					FEED	570	578	570	570	512	360	
S	31-35	Heat Resistant Super Alloys	0.05D	1.0D	Vc	45	45	41	45	40	41	
					fz	0.02	0.025	0.037	0.04	0.028	0.025	
					RPM	2387	1790	1305	1194	796	653	
					FEED	191	179	193	191	111	98	
	36-37	Titanium Alloys	1.0D	0.4~10:0.15D 0.12~16:0.10D 0.18~25:0.05D	Vc	158	158	160	158	166	151	
					fz	0.017	0.023	0.028	0.034	0.031	0.025	
					RPM	8382	6287	5093	4191	3302	2403	
					FEED	570	578	570	570	512	360	
	H	40	Chilled Cast Iron	0.3D	1.5D	Vc	234	231	239	226	241	226
						fz	0.017	0.023	0.028	0.033	0.032	0.026
						RPM	12414	9191	7608	5995	4795	3597
						FEED	844	846	852	791	767	561

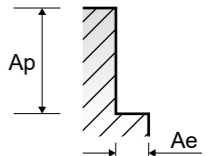



Global Cutting Tool Leader **YG-1**



MILLING



Leading Through Innovation



SOLID CARBIDE



V7 PLUS END MILLS

V7 Plus VHM - Schaftfräser

- High Performance Carbide End Mills for Steels, Cast Iron and Stainless Steels
- Hochleistungs-VHM-Schaftfräser für Stähle, Gusseisen und rostfreie Stähle

SELECTION GUIDE



SOLID CARBIDE V7 PLUS END MILLS

High performance carbide end mills for Steels, Cast Iron and Stainless Steels



Please visit globallyg1.com/mat for material search

⊙ : Excellent ○ : Good

Recommended cutting conditions : p. C436

Table with columns: ISO, VDI 3323, Material Description, Composition / Structure / Heat Treatment, HB, HRc, GMG55, GMF54, GMF58. Rows include P (Non-alloy and Low alloy steel), M (Stainless steel), K (Grey and Nodular cast iron, Malleable cast iron), N (Aluminum and Copper alloys), S (Heat Resistant Super Alloys, Titanium Alloys), and H (Hardened steel, Chilled Cast Iron, Hardened Cast Iron).

Series specifications table for GMG55, GMF54, GMF58 with columns for Flute, Helix Angle, Cutting Edge Shape, Size Min, Size Max, and Page.



Series specifications table for GMF62, GMF52, GMF56, GMF60, GMG16, GMG18, GMH58, GMG12, GMG14, GMH56, EMB72. Includes additional columns for GMF63, GMF53, GMF57, GMF61, GMG17, GMG19, GMH59, GMG13, GMG15, GMH57, EMB73.



Material compatibility table for the GMF62-EMB72 series, with rows corresponding to ISO standards 1 through 41 and columns corresponding to each tool model. Contains circles (○) and squares (◻) indicating suitability.



PLAIN SHANK **GMG55** SERIES
 FLAT SHANK **GMG56** SERIES

CARBIDE, 4 FLUTE BALL NOSE

- VOLLHARTMETALL, 4 SCHNEIDEN STIRNRADIUS
- CARBURE, 4 DENTS, HÉMISPHERIQUE
- MD, 4 TAGLIENTI SEMISFERICA

►Special flute geometry and multiple helix eliminate vibrations
 ►Excellent performance for Stainless Steels, Mild Steels, Cast Iron, Low/Medium hardness materials under HRC40

►Die spezielle Schneidengeometrie und der ungleiche Drill verhindern Vibrationen
 ►Exzellente Leistung in Edeltählen, Baustählen, Guss und Stählen unter 40HRc

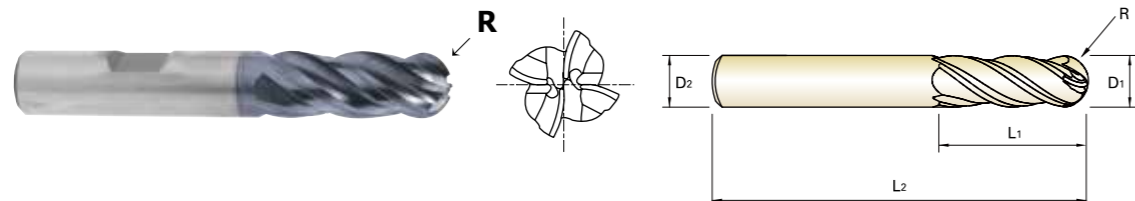

CARBIDE 4 35°/37° ±0.02 PLAIN FLAT Coating Y p.C436

Flat Shank	Page	Plain Shank	Page
END MILL HOLDER	D118-137	POWER MILLING CHUCK	D161-176
-	-	SHRINK FIT HOLDER	D47-72
-	-	HYDRAULIC CHUCK	D15-46
-	-	ER COLLET CHUCK	D73-116
-	-	SK SLIM CHUCK	D183-201

Unit : mm

EDP No.	Radius of Ball Nose		Mill Diameter	Shank Diameter		Length of Cut		Overall Length
	PLAIN	FLAT		R	D1	D2	L1	
GMG55030	GMG56030	R1.5	3.0	6	8	57		
GMG55040	GMG56040	R2.0	4.0	6	11	57		
GMG55050	GMG56050	R2.5	5.0	6	13	57		
GMG55060	GMG56060	R3.0	6.0	6	13	57		
GMG55080	GMG56080	R4.0	8.0	8	19	63		
GMG55100	GMG56100	R5.0	10.0	10	22	72		
GMG55120	GMG56120	R6.0	12.0	12	26	83		
GMG55160	GMG56160	R8.0	16.0	16	32	92		
GMG55200	GMG56200	R10.0	20.0	20	38	104		
GMG55250	GMG56250	R12.5	25.0	25	38	104		

Mill Dia. Tolerance (mm)	Shank Dia. Tolerance
Up to Ø12	0 ~ - 0.02 h5
Over Ø12	0 ~ - 0.03 * Shank Dia. ≥ Ø12 : h6

◎ : Excellent ○ : Good

ISO	P										M				K					
	Non-alloy steel					Low alloy steel					High alloyed steel, and tool steel		Stainless steel		Grey cast iron		Nodular cast iron		Malleable cast iron	
Material Description	1	2	3	4	5	6	7	8	9	10	11	12	13	14	15	16	17	18	19	20
VDI 3323	1	2	3	4	5	6	7	8	9	10	11	12	13	14	15	16	17	18	19	20
HRc	13	25	28	32	35	38	42	45	48	50	55	58	60	62	65	68	70	72	75	78
HB	125	190	250	270	300	180	275	300	350	200	325	200	240	180	180	260	160	250	130	230
Recommend	◎	◎	◎	◎	◎	◎	◎	◎	◎	◎	◎	◎	◎	◎	◎	◎	◎	◎	◎	◎



PLAIN SHANK **GMF54** SERIES
 FLAT SHANK **GMF55** SERIES

CARBIDE, 4 FLUTE CORNER RADIUS SHORT LENGTH

- VOLLHARTMETALL, 4 SCHNEIDEN ECKENRADIUS KURZ
- CARBURE, 4 DENTS, SÉRIE COURTE, RAYONNÉE
- MD, 4 TAGLIENTI SERIE CORTA TORICA

►Special flute geometry and multiple helix eliminate vibrations
 ►Excellent performance for Stainless Steels, Mild Steels, Cast Iron, Low/Medium hardness materials under HRC40

►Die spezielle Schneidengeometrie und der ungleiche Drill verhindern Vibrationen
 ►Exzellente Leistung in Edeltählen, Baustählen, Guss und Stählen unter 40HRc

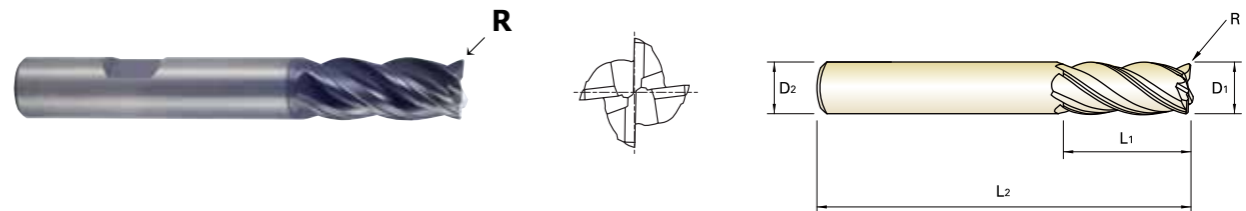

CARBIDE 4 35°/37° PLAIN FLAT Coating Y p.C437

Flat Shank	Page	Plain Shank	Page
END MILL HOLDER	D118-137	POWER MILLING CHUCK	D161-176
-	-	SHRINK FIT HOLDER	D47-72
-	-	HYDRAULIC CHUCK	D15-46
-	-	ER COLLET CHUCK	D73-116
-	-	SK SLIM CHUCK	D183-201

Unit : mm

EDP No.	Corner Radius		Mill Diameter	Shank Diameter		Length of Cut		Overall Length
	PLAIN	FLAT		R	D1	D2	L1	
GMF54030	GMF55030	R0.3	3.0	6	7	54		
GMF54901	GMF55901	R0.5	3.0	6	7	54		
GMF54040	GMF55040	R0.3	4.0	6	8	54		
GMF54902	GMF55902	R0.5	4.0	6	8	54		
GMF54050	GMF55050	R0.3	5.0	6	10	54		
GMF54903	GMF55903	R0.5	5.0	6	10	54		
GMF54060	GMF55060	R0.3	6.0	6	10	54		
GMF54904	GMF55904	R0.5	6.0	6	10	54		
GMF54905	GMF55905	R1.0	6.0	6	10	54		
GMF54080	GMF55080	R0.5	8.0	8	12	58		
GMF54906	GMF55906	R1.0	8.0	8	12	58		
GMF54100	GMF55100	R0.5	10.0	10	14	66		
GMF54907	GMF55907	R1.0	10.0	10	14	66		
GMF54120	GMF55120	R0.5	12.0	12	16	73		
GMF54908	GMF55908	R1.0	12.0	12	16	73		
GMF54909	GMF55909	R2.0	12.0	12	16	73		
GMF54140	GMF55140	R0.5	14.0	14	18	75		
GMF54160	GMF55160	R1.0	16.0	16	22	82		
GMF54912	GMF55912	R2.0	16.0	16	22	82		
GMF54913	GMF55913	R3.0	16.0	16	22	82		
GMF54180	GMF55180	R1.0	18.0	18	24	84		
GMF54200	GMF55200	R1.0	20.0	20	26	92		
GMF54916	GMF55916	R2.0	20.0	20	26	92		
GMF54917	GMF55917	R3.0	20.0	20	26	92		

Mill Dia. Tolerance (mm)	Shank Dia. Tolerance
Up to Ø12	0 ~ - 0.02 h5
Over Ø12	0 ~ - 0.03 * Shank Dia. ≥ Ø12 : h6

◎ : Excellent ○ : Good

ISO	P										M				K					
	Non-alloy steel					Low alloy steel					High alloyed steel, and tool steel		Stainless steel		Grey cast iron		Nodular cast iron		Malleable cast iron	
Material Description	1	2	3	4	5	6	7	8	9	10	11	12	13	14	15	16	17	18	19	20
VDI 3323	1	2	3	4	5	6	7	8	9	10	11	12	13	14	15	16	17	18	19	20
HRc	13	25	28	32	35	38	42	45	48	50	55	58	60	62	65	68	70	72	75	78
HB	125	190	250	270	300	180	275	300	350	200	325	200	240	180	180	260	160	250	130	230
Recommend	◎	◎	◎	◎	◎	◎	◎	◎	◎	◎	◎	◎	◎	◎	◎	◎	◎	◎	◎	◎

CARBIDE, 4 FLUTE CORNER RADIUS LONG LENGTH

- VOLLHARTMETALL, 4 SCHNEIDEN ECKENRADIUS LANG
CARBURE, 4 DENTS, SÉRIE LONGUE, RAYONNÉE
MD, 4 TAGLIENTI SERIE LUNGA TORICA

Special flute geometry and multiple helix eliminate vibrations
Excellent performance for Stainless Steels, Mild Steels, Cast Iron, Low/Medium hardness materials under HRc40

Die spezielle Schneidengeometrie und der ungleiche Drill verhindern Vibrationen
Exzellente Leistung in Edelstählen, Baustählen, Guss und Stählen unter 40HRc

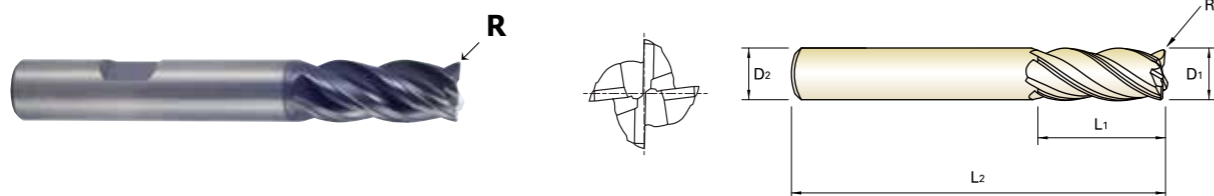

Product icons: CARBIDE, 4, 35°/37°, PLAIN, FLAT, Coating, Y, p.C437. Recommended Tool Holder table with Flat Shank and Plain Shank options.

Unit : mm

Main product table with columns: EDP No., Corner Radius, Mill Diameter, Shank Diameter, Length of Cut, Overall Length. Rows include models GMF58030 to GMF58250.

Table with Mill Dia. Tolerance (mm) and Shank Dia. Tolerance. Values: Up to Ø12 (0 ~ -0.02), Over Ø12 (0 ~ -0.03).

◎ : Excellent ○ : Good

ISO material compatibility table with columns for Non-alloy steel, Low alloy steel, High alloyed steel, Stainless steel, Grey cast iron, Nodular cast iron, Malleable cast iron, Aluminum-wrought alloy, Aluminum-cast, alloyed, Copper and Copper Alloys, Non Metallic Materials, Heat Resistant Super Alloys, Titanium Alloys, Hardened steel, Chilled Cast Iron, Hardened Cast Iron.

CARBIDE, 4 FLUTE CORNER RADIUS with EXTENDED NECK

- VOLLHARTMETALL, 4 SCHNEIDEN ECKENRADIUS mit ABGESETZTEM HALS
CARBURE, 4 DENTS, DÉTALONNÉE, RAYONNÉE
MD, 4 TAGLIENTI CON SCARICO ESTESO TORICA

Special flute geometry and multiple helix eliminate vibrations
Excellent performance for Stainless Steels, Mild Steels, Cast Iron, Low/Medium hardness materials under HRc40

Die spezielle Schneidengeometrie und der ungleiche Drill verhindern Vibrationen
Exzellente Leistung in Edelstählen, Baustählen, Guss und Stählen unter 40HRc

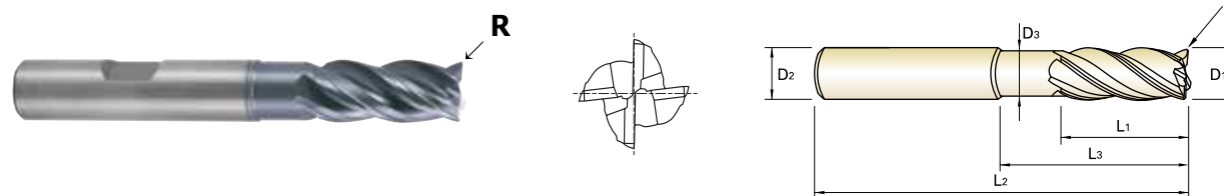

Product icons: CARBIDE, 4, 35°/37°, PLAIN, FLAT, Coating, Y, p.C437. Recommended Tool Holder table with Flat Shank and Plain Shank options.

Unit : mm

Main product table with columns: EDP No., Corner Radius, Mill Diameter, Shank Diameter, Length of Cut, Length Below Shank, Overall Length, Neck Diameter. Rows include models GMF62030 to GMF62919.

Table with Mill Dia. Tolerance (mm) and Shank Dia. Tolerance. Values: Up to Ø12 (0 ~ -0.02), Over Ø12 (0 ~ -0.03).

◎ : Excellent ○ : Good

ISO material compatibility table with columns for Non-alloy steel, Low alloy steel, High alloyed steel, Stainless steel, Grey cast iron, Nodular cast iron, Malleable cast iron, Aluminum-wrought alloy, Aluminum-cast, alloyed, Copper and Copper Alloys, Non Metallic Materials, Heat Resistant Super Alloys, Titanium Alloys, Hardened steel, Chilled Cast Iron, Hardened Cast Iron.



PLAIN SHANK GMF52 SERIES
FLAT SHANK GMF53 SERIES

CARBIDE, 4 FLUTE SHORT LENGTH

VOLLHARTMETALL, 4 SCHNEIDEN KURZ
CARBURE, 4 DENTS, SÉRIE COURTE
MD, 4 TAGLIENTI SERIE CORTA

Special flute geometry and multiple helix eliminate vibrations
Excellent performance for Stainless Steels, Mild Steels, Cast Iron, Low/Medium hardness materials under HRc40

Die spezielle Schneidengeometrie und der ungleiche Drill verhindern Vibrationen
Exzellente Leistung in Edelstählen, Baustählen, Guss und Stählen unter 40HRc

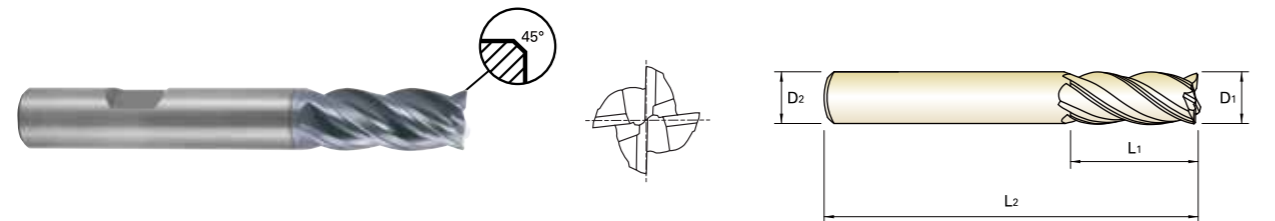

Icons for Carbide, 4 flutes, 35°/37° angle, Plain/Flat shank, C x 45° coating, Y coating, p.C437, and Recommended ToolHolder table.

Table with 7 columns: EDP No., Mill Diameter, Shank Diameter, Length of Cut, Overall Length, Chamfer. Rows include GMF52030 to GMF52200.

Table with 2 columns: Mill Dia. Tolerance (mm) and Shank Dia. Tolerance. Values range from 0 ~ - 0.02 to h5.

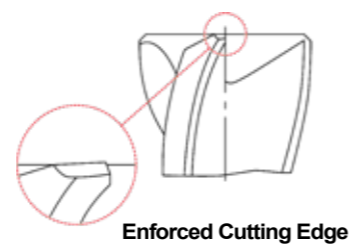

ISO material compatibility chart with columns for P (Non-alloy steel), M (Stainless steel), K (Grey cast iron), N (Aluminum), S (Heat Resistant Super Alloys), and H (Titanium Alloys).



PLAIN SHANK GMF56 SERIES
FLAT SHANK GMF57 SERIES

CARBIDE, 4 FLUTE LONG LENGTH

VOLLHARTMETALL, 4 SCHNEIDEN LANG
CARBURE, 4 DENTS, SÉRIE LONGUE
MD, 4 TAGLIENTI SERIE LUNGA

Special flute geometry and multiple helix eliminate vibrations
Excellent performance for Stainless Steels, Mild Steels, Cast Iron, Low/Medium hardness materials under HRc40

Die spezielle Schneidengeometrie und der ungleiche Drill verhindern Vibrationen
Exzellente Leistung in Edelstählen, Baustählen, Guss und Stählen unter 40HRc

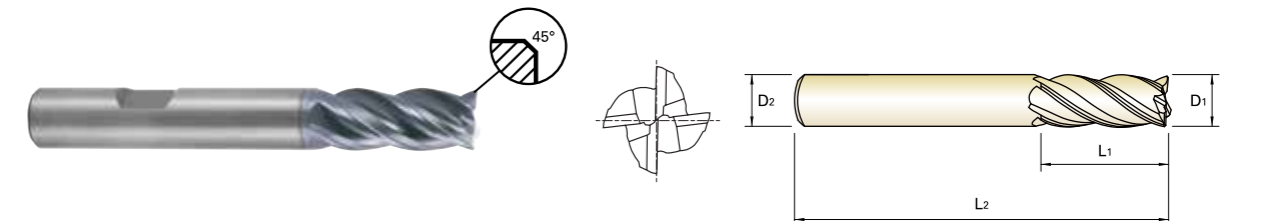

Icons for Carbide, 4 flutes, 35°/37° angle, Plain/Flat shank, C x 45° coating, Y coating, p.C437, and Recommended ToolHolder table.

Table with 7 columns: EDP No., Mill Diameter, Shank Diameter, Length of Cut, Overall Length, Chamfer. Rows include GMF56030 to GMF56250.

Table with 2 columns: Mill Dia. Tolerance (mm) and Shank Dia. Tolerance. Values range from 0 ~ - 0.02 to h5.

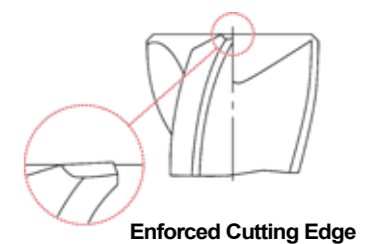

ISO material compatibility chart with columns for P (Non-alloy steel), M (Stainless steel), K (Grey cast iron), N (Aluminum), S (Heat Resistant Super Alloys), and H (Titanium Alloys).



PLAIN SHANK GMG16 SERIES
FLAT SHANK GMG17 SERIES

CARBIDE, 6 FLUTE CORNER RADIUS LONG LENGTH

- VOLLHARTMETALL, 6 SCHNEIDEN ECKENRADIUS LANG
CARBURE, 6 DENTS, SÉRIE LONGUE, RAYONNÉE
MD, 6 TAGLIENTI SERIE LUNGA TORICA

The unique geometry of the variable pitch provides the best chatter free tool for high speed and trochoidal milling
Excellent performance for Stainless Steels, Mild Steels, Cast Iron, Low/Medium hardness materials under HRc40

Durch die einzigartige Geometrie und die ungleiche Teilung der Schneiden, eignet sich Fräser Bestens für hohe Bearbeitungsgeschwindigkeiten und trochoidales Fräsen.
Exzellente Leistung in Edelstählen, Baustählen, Guss und Stählen unter 40HRc

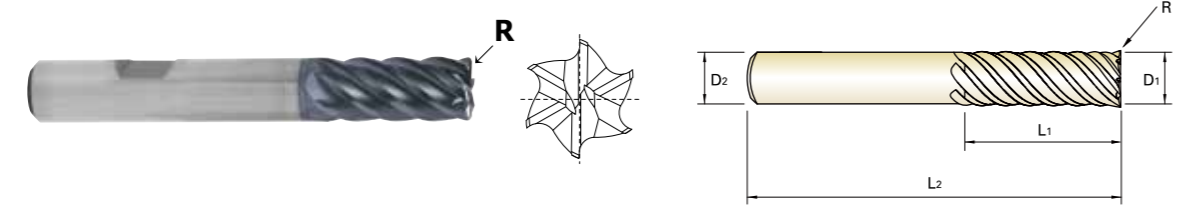

Icons for Carbide, 6 flutes, 45 degree angle, Plain/Flat shank, Coating, and p.C438.

Recommended Tool Holder table listing Flat Shank and Plain Shank options with corresponding page numbers.

Main product catalog table for GMG16/17 series with columns for EDP No., Corner Radius, Mill Diameter, Shank Diameter, Length of Cut, and Overall Length.

Table showing Mill Dia. Tolerance (mm) and Shank Dia. Tolerance (h5, h6).

ISO material compatibility chart for GMG16/17 series, categorized by P, M, K, N, S, H groups.



PLAIN SHANK GMG18 SERIES
FLAT SHANK GMG19 SERIES

CARBIDE, 6 FLUTE CORNER RADIUS EXTRA LONG LENGTH

- VOLLHARTMETALL, 6 SCHNEIDEN ECKENRADIUS EXTRA LANG
CARBURE, 6 DENTS, SÉRIE EXTRA-LONGUE, RAYONNÉE
MD, 6 TAGLIENTI SERIE EXTRA LUNGA TORICA

The unique geometry of the variable pitch provides the best chatter free tool for high speed and trochoidal milling
Excellent performance for Stainless Steels, Mild Steels, Cast Iron, Low/Medium hardness materials under HRc40

Durch die einzigartige Geometrie und die ungleiche Teilung der Schneiden, eignet sich Fräser Bestens für hohe Bearbeitungsgeschwindigkeiten und trochoidales Fräsen.
Exzellente Leistung in Edelstählen, Baustählen, Guss und Stählen unter 40HRc

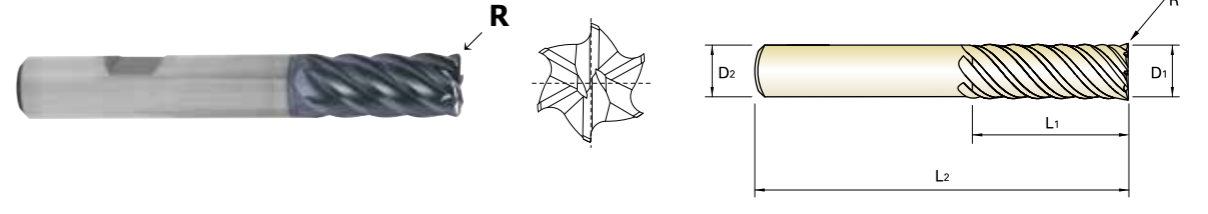

Icons for Carbide, 6 flutes, 45 degree angle, Plain/Flat shank, Coating, and p.C438.

Recommended Tool Holder table listing Flat Shank and Plain Shank options with corresponding page numbers.

Main product catalog table for GMG18/19 series with columns for EDP No., Corner Radius, Mill Diameter, Shank Diameter, Length of Cut, and Overall Length.

Table showing Mill Dia. Tolerance (mm) and Shank Dia. Tolerance (h5, h6).

ISO material compatibility chart for GMG18/19 series, categorized by P, M, K, N, S, H groups.



PLAIN SHANK **GMG18** SERIES
 FLAT SHANK **GMG19** SERIES

CARBIDE, 6 FLUTE CORNER RADIUS EXTRA LONG LENGTH

- VOLLHARTMETALL, 6 SCHNEIDEN ECKENRADIUS EXTRA LANG
- CARBURE, 6 DENTS, SÉRIE EXTRA-LONGUE, RAYONNÉE
- MD, 6 TAGLIENTI SERIE EXTRA LUNGA TORICA

The unique geometry of the variable pitch provides the best chatter free tool for high speed and trochoidal milling
 Excellent performance for Stainless Steels, Mild Steels, Cast Iron, Low/Medium hardness materials under HRc40

Durch die einzigartige Geometrie und die ungleiche Teilung der Schneiden, eignet sich Fräser Bestens für hohe Bearbeitungsgeschwindigkeiten und trochoidales Fräsen.
 Exzellente Leistung in Edelstählen, Baustählen, Guss und Stählen unter 40HRc

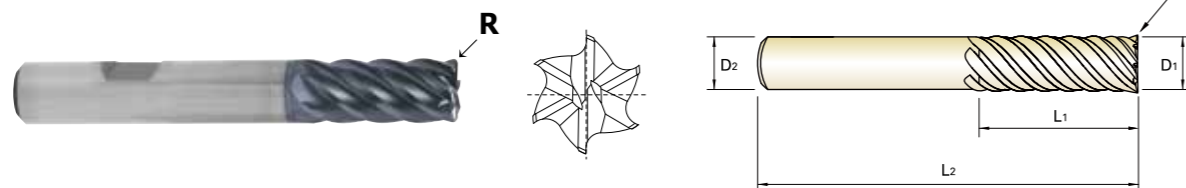

CARBIDE 6 45° PLAIN FLAT Coating Y p.C438

Flat Shank	Page	Plain Shank	Page
END MILL HOLDER	D118-137	POWER MILLING CHUCK	D161-176
-	-	SHRINK FIT HOLDER	D47-72
-	-	HYDRAULIC CHUCK	D15-46
-	-	ER COLLET CHUCK	D73-116
-	-	SK SLIM CHUCK	D183-201

Unit : mm

EDP No.	Corner Radius	Mill Diameter		Shank Diameter	Length of Cut	Overall Length
		PLAIN	FLAT			
GMG18250	GMG19250	R1.0	25.0	25	100	170
GMG18919	GMG19919	R1.5	25.0	25	100	170
GMG18920	GMG19920	R2.0	25.0	25	100	170
GMG18921	GMG19921	R3.0	25.0	25	100	170
GMG18922	GMG19922	R4.0	25.0	25	100	170
GMG18923	GMG19923	R5.0	25.0	25	100	170

Mill Dia. Tolerance (mm)	Shank Dia. Tolerance
0 ~ - 0.03	h5 * Shank Dia. ≥ Ø12 : h6

◎ : Excellent ○ : Good

ISO Material Description	P					M					K									
	Non-alloy steel					Low alloy steel					High alloyed steel, and tool steel									
VDI 3323	1	2	3	4	5	6	7	8	9	10	11	12	13	14	15	16	17	18	19	20
HRc	13	25	28	32	38	10	29	32	38	15	35	15	23	10	10	26	3	25	21	
HB	125	190	250	270	300	180	275	300	350	200	325	200	240	180	180	260	160	250	130	230
Recommend	◎	◎	◎	◎	◎	◎	◎	◎	◎	◎	◎	◎	◎	◎	◎	◎	◎	◎	◎	◎



PLAIN SHANK **GMH58** SERIES
 FLAT SHANK **GMH59** SERIES

6 FLUTE CORNER RADIUS EXTRA LONG LENGTH CHIP SPLITTER

- VOLLHARTMETALL, 6 SCHNEIDEN ECKRADIUS EXTRA LANG SPANTEILER
- CARBURE, 6 dents, extra-longue, fendeur des copeaux
- MD, 6 TAGLIENTI, TORICA, SERIE EXTRA LUNGA CON ROMPI TRUCIOLO

Special chip splitter design for better chip removal shortened chip length at high axial machining
 High Performance for Steels, Stainless Steels and Cast Iron

Spezielles Spanteilerdesign für verbesserte Spanabfuhr durch kurze Späne bei hohem axialen Eingriff
 Hohe Leistung bei der Bearbeitung von Stählen, rostfreien Stählen und Gusseisen.

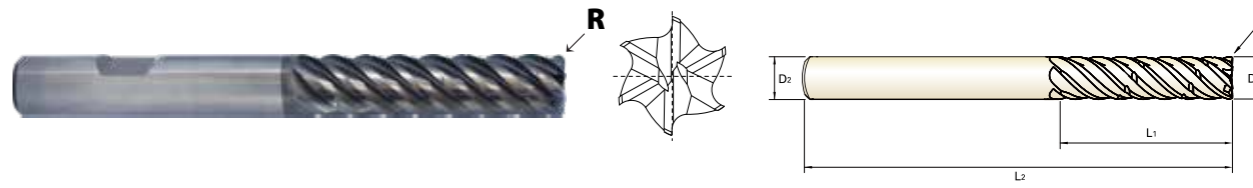

CARBIDE 6 45° PLAIN FLAT Coating Y p.C439

Flat Shank	Page	Plain Shank	Page
END MILL HOLDER	D118-137	POWER MILLING CHUCK	D161-176
-	-	SHRINK FIT HOLDER	D47-72
-	-	HYDRAULIC CHUCK	D15-46
-	-	ER COLLET CHUCK	D73-116
-	-	SK SLIM CHUCK	D183-201

Unit : mm

EDP No.	Corner Radius	Mill Diameter		Shank Diameter	Length of Cut	Overall Length
		PLAIN	FLAT			
GMH58916	GMH59916	R3.0	20.0	20	80	150
GMH58917	GMH59917	R4.0	20.0	20	80	150
GMH58918	GMH59918	R5.0	20.0	20	80	150
GMH58250	GMH59250	R1.0	25.0	25	100	170
GMH58919	GMH59919	R1.5	25.0	25	100	170
GMH58920	GMH59920	R2.0	25.0	25	100	170
GMH58921	GMH59921	R3.0	25.0	25	100	170
GMH58922	GMH59922	R4.0	25.0	25	100	170
GMH58923	GMH59923	R5.0	25.0	25	100	170

Mill Dia. Tolerance (mm)	Shank Dia. Tolerance
0 ~ - 0.03	h5 * Shank Dia. ≥ Ø12 : h6

◎ : Excellent ○ : Good

ISO Material Description	P					M					K									
	Non-alloy steel					Low alloy steel					High alloyed steel, and tool steel									
VDI 3323	1	2	3	4	5	6	7	8	9	10	11	12	13	14	15	16	17	18	19	20
HRc	13	25	28	32	38	10	29	32	38	15	35	15	23	10	10	26	3	25	21	
HB	125	190	250	270	300	180	275	300	350	200	325	200	240	180	180	260	160	250	130	230
Recommend	◎	◎	◎	◎	◎	◎	◎	◎	◎	◎	◎	◎	◎	◎	◎	◎	◎	◎	◎	◎



PLAIN SHANK **GMG12** SERIES
 FLAT SHANK **GMG13** SERIES

CARBIDE, 6 FLUTE LONG LENGTH

- VOLLHARTMETALL, 6 SCHNEIDEN, LANG
- CARBURE, 6 DENTS, SÉRIE -LONGUE
- MD, 6 TAGLIENTI SERIE LUNGA

► The unique geometry of the variable pitch provides the best chatter free tool for high speed and trochoidal milling
 ► Excellent performance for Stainless Steels, Mild Steels, Cast Iron, Low/Medium hardness materials under HRc40

► Durch die einzigartige Geometrie und die ungleiche Teilung der Schneiden, eignet sich Fräser Bestens für hohe Bearbeitungsgeschwindigkeiten und trochoidales Fräsen.
 ► Exzellente Leistung in Edelstählen, Baustählen, Guss und Stählen unter 40HRc

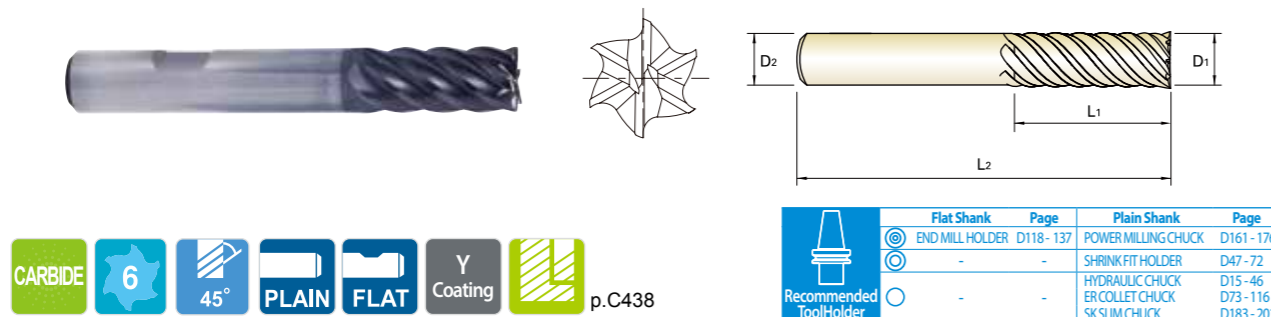

Unit : mm

EDP No.		Mill Diameter	Shank Diameter	Length of Cut	Overall Length
PLAIN	FLAT	D1	D2	L1	L2
GMG12060	GMG13060	6.0	6	13	57
GMG12080	GMG13080	8.0	8	19	63
GMG12100	GMG13100	10.0	10	22	72
GMG12120	GMG13120	12.0	12	26	83
GMG12160	GMG13160	16.0	16	32	92
GMG12200	GMG13200	20.0	20	38	104
GMG12250	GMG13250	25.0	25	44	104

Mill Dia. Tolerance (mm)	Shank Dia. Tolerance
Up to Ø12	0 ~ - 0.02 h5
Over Ø12	0 ~ - 0.03 * Shank Dia. ≥ Ø12 : h6

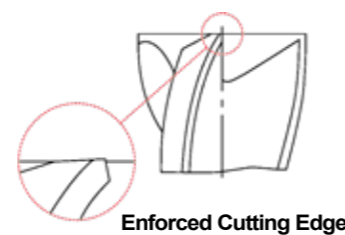

◎ : Excellent ○ : Good

ISO Material Description	P										M				K					
	Non-alloy steel					Low alloy steel					High alloyed steel, and tool steel		Stainless steel		Grey cast iron	Nodular cast iron		Malleable cast iron		
VDI 3323	1	2	3	4	5	6	7	8	9	10	11	12	13	14	15	16	17	18	19	20
HRc	13	25	28	32	38	10	29	32	38	15	35	15	23	10	10	26	3	25	21	
HB	125	190	250	270	300	180	275	300	350	200	325	200	240	180	180	260	160	250	130	230
Recommend	◎	◎	◎	◎	◎	◎	◎	◎	◎	◎	◎	◎	◎	◎	◎	◎	◎	◎	◎	◎

ISO Material Description	N				S						H										
	Aluminum-wrought alloy		Aluminum-cast, alloyed		Copper and Copper Alloys (Bronze / Brass)		Non Metallic Materials		Heat Resistant Super Alloys				Titanium Alloys	Hardened steel	Chilled Cast Iron	Hardened Cast Iron					
VDI 3323	21	22	23	24	25	26	27	28	29	30	31	32	33	34	35	36	37	38	39	40	41
HRc	21	22	23	24	25	26	27	28	29	30	31	32	33	34	35	36	37	38	39	40	41
HB	60	100	75	90	130	110	90	100			200	280	250	350	320	400 Rm	1050 Rm	550	630	400	550
Recommend	◎	◎	◎	◎	◎	◎	◎	◎	◎	◎	◎	◎	◎	◎	◎	◎	◎	◎	◎	◎	◎



PLAIN SHANK **GMG14** SERIES
 FLAT SHANK **GMG15** SERIES

CARBIDE, 6 FLUTE EXTRA LONG LENGTH

- VOLLHARTMETALL, 6 SCHNEIDEN, EXTRA LANG
- CARBURE, 6 DENTS, SÉRIE EXTRA-LONGUE
- MD, 6 TAGLIENTI SERIE EXTRA LUNGA

► The unique geometry of the variable pitch provides the best chatter free tool for high speed and trochoidal milling
 ► Excellent performance for Stainless Steels, Mild Steels, Cast Iron, Low/Medium hardness materials under HRc40

► Durch die einzigartige Geometrie und die ungleiche Teilung der Schneiden, eignet sich Fräser Bestens für hohe Bearbeitungsgeschwindigkeiten und trochoidales Fräsen.
 ► Exzellente Leistung in Edelstählen, Baustählen, Guss und Stählen unter 40HRc

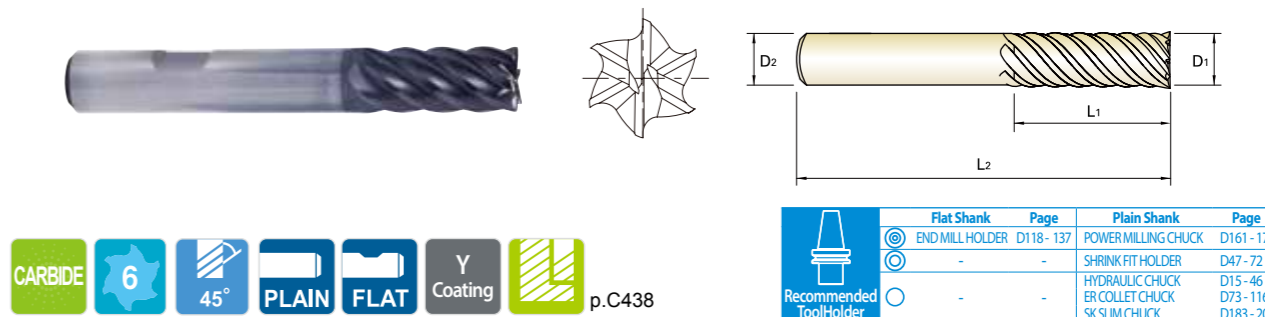

Unit : mm

EDP No.		Mill Diameter	Shank Diameter	Length of Cut	Overall Length
PLAIN	FLAT	D1	D2	L1	L2
GMG14060	GMG15060	6.0	6	24	75
GMG14080	GMG15080	8.0	8	32	75
GMG14100	GMG15100	10.0	10	40	100
GMG14120	GMG15120	12.0	12	48	120
GMG14160	GMG15160	16.0	16	64	140
GMG14200	GMG15200	20.0	20	80	150
GMG14250	GMG15250	25.0	25	100	170

Mill Dia. Tolerance (mm)	Shank Dia. Tolerance
0 ~ - 0.03	h5 * Shank Dia. ≥ Ø12 : h6

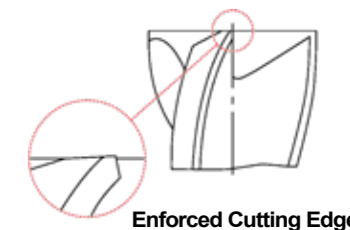

◎ : Excellent ○ : Good

ISO Material Description	P										M				K					
	Non-alloy steel					Low alloy steel					High alloyed steel, and tool steel		Stainless steel		Grey cast iron	Nodular cast iron		Malleable cast iron		
VDI 3323	1	2	3	4	5	6	7	8	9	10	11	12	13	14	15	16	17	18	19	20
HRc	13	25	28	32	38	10	29	32	38	15	35	15	23	10	10	26	3	25	21	
HB	125	190	250	270	300	180	275	300	350	200	325	200	240	180	180	260	160	250	130	230
Recommend	◎	◎	◎	◎	◎	◎	◎	◎	◎	◎	◎	◎	◎	◎	◎	◎	◎	◎	◎	◎

ISO Material Description	N				S						H										
	Aluminum-wrought alloy		Aluminum-cast, alloyed		Copper and Copper Alloys (Bronze / Brass)		Non Metallic Materials		Heat Resistant Super Alloys				Titanium Alloys	Hardened steel	Chilled Cast Iron	Hardened Cast Iron					
VDI 3323	21	22	23	24	25	26	27	28	29	30	31	32	33	34	35	36	37	38	39	40	41
HRc	21	22	23	24	25	26	27	28	29	30	31	32	33	34	35	36	37	38	39	40	41
HB	60	100	75	90	130	110	90	100			200	280	250	350	320	400 Rm	1050 Rm	550	630	400	550
Recommend	◎	◎	◎	◎	◎	◎	◎	◎	◎	◎	◎	◎	◎	◎	◎	◎	◎	◎	◎	◎	◎



PLAIN SHANK **GMH56** SERIES
FLAT SHANK **GMH57** SERIES

CARBIDE, 6 FLUTE EXTRA LONG LENGTH CHIP SPLITTER

● VOLLHARTMETALL, 6-SCHNEIDEN-SPANTEILER MIT EXTRA LANGER LÄNGE
● Carbure, 6 Dents, Torique, Extra-Longue, Fendeur Des Copeaux
● MD, 6 TAGLIENTI, SERIE EXTRA LUNGA CON ROMPI TRUCIOLO

- Special chip splitter design for better chip removal shortened chip length at high axial machining
- High Performance for Steels, Stainless Steels and Cast Iron

- Spezielles Spanteilerdesign für verbesserte Spanabfuhr durch kurze Späne bei hohem axialen Eingriff
- Hohe Leistung bei der Bearbeitung von Stählen, rostfreien Stählen und Gusseisen.

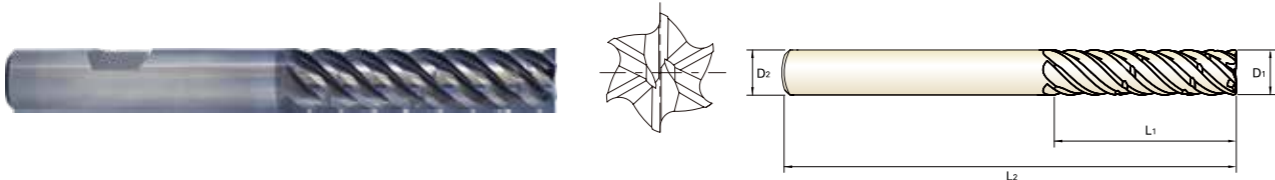

CARBIDE 6 45° PLAIN FLAT Coating Y p.C439

Flat Shank	Page	Plain Shank	Page
END MILL HOLDER	D118-137	POWER MILLING CHUCK	D161-176
-	-	SHRINK FIT HOLDER	D47-72
-	-	HYDRAULIC CHUCK	D15-46
-	-	ER COLLET CHUCK	D73-116
-	-	SK SLIM CHUCK	D183-201

Unit : mm

EDP No.		Mill Diameter	Shank Diameter	Length of Cut	Overall Length
PLAIN	FLAT	D1	D2	L1	L2
GMH56060	GMH57060	6.0	6	24	75
GMH56080	GMH57080	8.0	8	32	75
GMH56100	GMH57100	10.0	10	40	100
GMH56120	GMH57120	12.0	12	48	120
GMH56160	GMH57160	16.0	16	64	140
GMH56200	GMH57200	20.0	20	80	150
GMH56250	GMH57250	25.0	25	100	170

Mill Dia. Tolerance (mm)	Shank Dia. Tolerance
0 ~ - 0.03	h5 * Shank Dia. ≥ Ø12 : h6

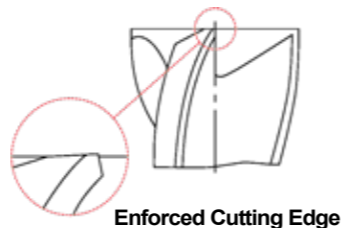

◎ : Excellent ○ : Good

ISO	P										M				K						
	Non-alloy steel					Low alloy steel					High alloyed steel, and tool steel				Stainless steel		Grey cast iron		Nodular cast iron		Malleable cast iron
Material Description	1	2	3	4	5	6	7	8	9	10	11	12	13	14	15	16	17	18	19	20	
VDI 3323	1	2	3	4	5	6	7	8	9	10	11	12	13	14	15	16	17	18	19	20	
HRc	13	25	28	32	10	29	32	38	15	35	15	23	10	10	26	3	25	10	21		
HB	125	190	250	270	300	180	275	300	350	200	325	200	240	180	180	260	160	250	130	230	
Recommend	◎	◎	◎	◎	◎	◎	◎	◎	◎	◎	◎	◎	◎	◎	◎	◎	◎	◎	◎	◎	◎

ISO	N				S				H													
	Aluminum-wrought alloy		Aluminum-cast, alloyed		Copper and Copper Alloys (Bronze / Brass)		Non Metallic Materials		Heat Resistant Super Alloys		Titanium Alloys	Hardened steel	Chilled Cast Iron	Hardened Cast Iron								
Material Description	21	22	23	24	25	26	27	28	29	30	31	32	33	34	35	36	37	38	39	40	41	
VDI 3323	21	22	23	24	25	26	27	28	29	30	31	32	33	34	35	36	37	38	39	40	41	
HRc	15	30	25	38	34	15	30	25	38	34	55	60	42	55								
HB	60	100	75	90	130	110	90	100			200	280	250	350	320	400 Rm	1050 Rm	550	630	400	550	
Recommend	◎	◎	◎	◎	◎	◎	◎	◎	◎	◎	◎	◎	◎	◎	◎	◎	◎	◎	◎	◎	◎	◎



PLAIN SHANK **EMB72** SERIES
FLAT SHANK **EMB73** SERIES

CARBIDE, 5 FLUTE LONG LENGTH

● VOLLHARTMETALL, 5 SCHNEIDEN LANG
● Fraise carbure, 5 dents, longue
● 5 TAGLIENTI, SERIE LUNGA, EVOLVENTE VARIABILE

- Special flute geometry eliminates vibrations
- Designed for mild steels, stainless steels, cast iron, tool steels, titanium alloys, prehardened steels and low hardness materials under HRc40
- Excellent finished work piece
- Higher speeds, deeper cuts and excellent metal removal rates

- Spezielle Schneidengeometrie verhindert Vibrationen
- Geeignet für Baustähle, Rostfreie Stähle, Grauguss, Werkzeugstähle, Titanlegierungen, hochfeste Stähle und Werkstoffe unter 40 HRC
- Bessere Werkstückoberflächen.
- Höhere Schnittgeschwindigkeiten, größere Profiltiefe und größeres Zerspanungsvolumen



CARBIDE 5 Sinusoidal PLAIN FLAT C x 45° AITiN p.C440

Flat Shank	Page	Plain Shank	Page
END MILL HOLDER	D118-137	POWER MILLING CHUCK	D161-176
-	-	SHRINK FIT HOLDER	D47-72
-	-	HYDRAULIC CHUCK	D15-46
-	-	ER COLLET CHUCK	D73-116
-	-	SK SLIM CHUCK	D183-201

Unit : mm

EDP No.		Mill Diameter	Shank Diameter	Length of Cut	Overall Length	Chamfer
PLAIN	FLAT					
EMB72060	EMB73060	6.0	6	13	57	0.1
EMB72080	EMB73080	8.0	8	19	63	0.1
EMB72100	EMB73100	10.0	10	22	72	0.1
EMB72120	EMB73120	12.0	12	26	83	0.1
EMB72140	EMB73140	14.0	14	26	83	0.2
EMB72160	EMB73160	16.0	16	32	92	0.2
EMB72180	EMB73180	18.0	18	32	92	0.2
EMB72200	EMB73200	20.0	20	38	104	0.2
EMB72250	EMB73250	25.0	25	38	104	0.2

Mill Dia. Tolerance (mm)	Shank Dia. Tolerance
0 ~ - 0.03	h5 * Shank Dia. ≥ Ø12 : h6

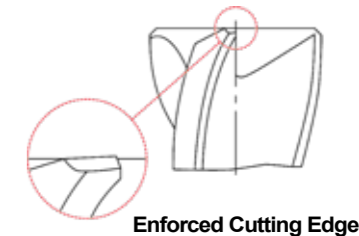

◎ : Excellent ○ : Good

ISO	P										M				K						
	Non-alloy steel					Low alloy steel					High alloyed steel, and tool steel				Stainless steel		Grey cast iron		Nodular cast iron		Malleable cast iron
Material Description	1	2	3	4	5	6	7	8	9	10	11	12	13	14	15	16	17	18	19	20	
VDI 3323	1	2	3	4	5	6	7	8	9	10	11	12	13	14	15	16	17	18	19	20	
HRc	13	25	28	32	10	29	32	38	15	35	15	23	10	10	26	3	25	10	21		
HB	125	190	250	270	300	180	275	300	350	200	325	200	240	180	180	260	160	250	130	230	
Recommend	◎	◎	◎	◎	◎	◎	◎	◎	◎	◎	◎	◎	◎	◎	◎	◎	◎	◎	◎	◎	◎

ISO	N				S				H													
	Aluminum-wrought alloy		Aluminum-cast, alloyed		Copper and Copper Alloys (Bronze / Brass)		Non Metallic Materials		Heat Resistant Super Alloys		Titanium Alloys	Hardened steel	Chilled Cast Iron	Hardened Cast Iron								
Material Description	21	22	23	24	25	26	27	28	29	30	31	32	33	34	35	36	37	38	39	40	41	
VDI 3323	21	22	23	24	25	26	27	28	29	30	31	32	33	34	35	36	37	38	39	40	41	
HRc	15	30	25	38	34	15	30	25	38	34	55	60	42	55								
HB	60	100	75	90	130	110	90	100			200	280	250	350	320	400 Rm	1050 Rm	550	630	400	550	
Recommend	◎	◎	◎	◎	◎	◎	◎	◎	◎	◎	◎	◎	◎	◎	◎	◎	◎	◎	◎	◎	◎	◎

HSS

HSS



RECOMMENDED CUTTING CONDITIONS
EMPFOHLENE SCHNEIDPARAMETER



RECOMMENDED CUTTING CONDITIONS
EMPFOHLENE SCHNEIDPARAMETER

GMG55, GMG56 SERIES 4 FLUTE BALL NOSE

Vc = m/min.
fz = mm/tooth
RPM = rev./min.
FEED = mm/min.

Table with columns for ISO, VDI 3323, Material Description, Ae, Ap, Parameter, and Diameter (Ø) from 3.0 to 25.0. Rows are categorized by material groups: P (Non-alloy steel, Low alloy steel, High alloyed steel, and tool steel), M (Stainless steel), K (Grey cast iron), and S (Heat Resistant Super Alloys, Titanium Alloys).

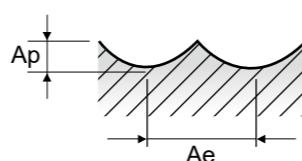

GMF52 GMF53 GMF54 GMF55 GMF56 GMF57 GMF58 GMF59 GMF60 GMF61 GMF62 GMF63 4 FLUTE - SIDE & SLOTING

Vc = m/min.
fz = mm/tooth
RPM = rev./min.
FEED = mm/min.

Table with columns for ISO, VDI 3323, Material Description, Ae (Side, Slotting), Ap (Side, Slotting), Parameter, and Diameter (Ø) from 3.0 to 25.0. Rows are categorized by material groups: P (Non-alloy steel, Low alloy steel, High alloyed steel, and tool steel), M (Stainless steel), K (Grey cast iron), and S (Heat Resistant Super Alloys, Titanium Alloys).

(*): Short length & Neck type

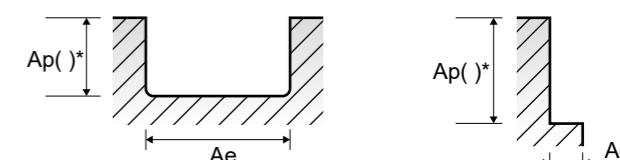



**RECOMMENDED CUTTING CONDITIONS
EMPFOHLENE SCHNEIDPARAMETER**

**GMG16
GMG17** **GMG18
GMG19** **GMG12
GMG13** **GMG14
GMG15** **6 FLUTE - SIDE CUTTING**

Vc = m/min.
fz = mm/tooth
RPM = rev./min.
FEED = mm/min.

ISO	VDI 3323	Material Description	Ae	Ap	Parameter	Diameter (Ø)						
						6.0	8.0	10.0	12.0	16.0	20.0	25.0
P	1-4	Non-alloy steel	0.05D	2.0D	Vc	300	300	300	300	300	300	300
					fz	0.068	0.116	0.144	0.173	0.202	0.225	0.232
	RPM	15915	11937	9549	7958	5968	4775	3820				
	FEED	6494	8308	8251	8260	7234	6446	5317				
5	Non-alloy steel	0.05D	2.0D	Vc	205	205	205	205	205	205	205	
				fz	0.050	0.085	0.106	0.128	0.149	0.167	0.174	
				RPM	10876	8157	6525	5438	4078	3263	2610	
6-7	Low alloy steel	0.05D	2.0D	Vc	300	300	300	300	300	300	300	
				fz	0.068	0.116	0.144	0.173	0.202	0.225	0.232	
				RPM	15915	11937	9549	7958	5968	4775	3820	
8-9	Low alloy steel	0.05D	2.0D	Vc	205	205	205	205	205	205	205	
				fz	0.050	0.085	0.106	0.128	0.149	0.167	0.174	
				RPM	10876	8157	6525	5438	4078	3263	2610	
10-11.1	High alloyed steel, and tool steel	0.05D	2.0D	Vc	100	100	100	100	100	100	100	
				fz	0.041	0.071	0.088	0.105	0.123	0.137	0.144	
				RPM	5305	3979	3183	2653	1989	1592	1273	
M	12-13	Stainless steel	0.05D	2.0D	Vc	215	215	215	215	215	215	215
					fz	0.049	0.084	0.104	0.125	0.146	0.162	0.168
	RPM	11406	8555	6844	5703	4277	3422	2737				
	FEED	3353	4312	4270	4277	3747	3326	2759				
14.1	Stainless steel	0.05D	2.0D	Vc	145	145	145	145	145	145	145	
				fz	0.041	0.071	0.088	0.105	0.123	0.137	0.143	
				RPM	7692	5769	4615	3846	2885	2308	1846	
14.2	Stainless steel	0.05D	2.0D	Vc	135	135	135	135	135	135	135	
				fz	0.041	0.071	0.088	0.105	0.123	0.137	0.142	
				RPM	7162	5371	4297	3581	2686	2149	1719	
K	15-20	Grey cast iron	0.05D	2.0D	Vc	225	225	225	225	225	225	225
					fz	0.082	0.139	0.173	0.208	0.242	0.270	0.278
					RPM	11937	8952	7162	5968	4476	3581	2865
					FEED	5844	7477	7426	7434	6510	5801	4785
S	31-35	Heat Resistant Super Alloys	0.05D	2.0D	Vc	35	35	35	35	35	35	35
					fz	0.033	0.055	0.070	0.082	0.097	0.112	0.115
					RPM	1857	1393	1114	928	696	557	446
					FEED	368	460	468	457	405	374	307
36-37	Titanium Alloys	0.05D	2.0D	Vc	115	115	115	115	115	115	115	
				fz	0.033	0.055	0.070	0.083	0.097	0.113	0.117	
				RPM	6101	4576	3661	3050	2288	1830	1464	
				FEED	1208	1510	1537	1519	1332	1241	1028	

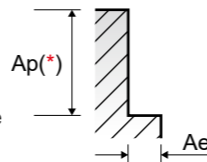

(*) : If product's Length of Cut(L.O.C) is below 2D, it must be applied with L.O.C x 90%



**RECOMMENDED CUTTING CONDITIONS
EMPFOHLENE SCHNEIDPARAMETER**

**GMH58
GMH59** **GMH56
GMH57** **6 FLUTE CHIP SPLITTER - SIDE CUTTING**

Vc = m/min.
fz = mm/tooth
RPM = rev./min.
FEED = mm/min.

ISO	VDI 3323	Material Description	Ae	Ap	Parameter	Diameter (Ø)						
						6.0	8.0	10.0	12.0	16.0	20.0	25.0
P	1-4	Non-alloy steel	0.05D	3.0D	Vc	300	300	300	300	300	300	300
					fz	0.068	0.116	0.144	0.173	0.202	0.225	0.232
	RPM	15915	11937	9549	7958	5968	4775	3820				
	FEED	6494	8308	8251	8260	7234	6446	5317				
5	Non-alloy steel	0.05D	3.0D	Vc	205	205	205	205	205	205	205	
				fz	0.050	0.085	0.106	0.128	0.149	0.167	0.174	
				RPM	10876	8157	6525	5438	4078	3263	2610	
6-7	Low alloy steel	0.05D	3.0D	Vc	300	300	300	300	300	300	300	
				fz	0.068	0.116	0.144	0.173	0.202	0.225	0.232	
				RPM	15915	11937	9549	7958	5968	4775	3820	
8-9	Low alloy steel	0.05D	3.0D	Vc	205	205	205	205	205	205	205	
				fz	0.050	0.085	0.106	0.128	0.149	0.167	0.174	
				RPM	10876	8157	6525	5438	4078	3263	2610	
10-11.1	High alloyed steel, and tool steel	0.05D	3.0D	Vc	100	100	100	100	100	100	100	
				fz	0.041	0.071	0.088	0.105	0.123	0.137	0.144	
				RPM	5305	3979	3183	2653	1989	1592	1273	
M	12-13	Stainless steel	0.05D	3.0D	Vc	215	215	215	215	215	215	215
					fz	0.049	0.084	0.104	0.125	0.146	0.162	0.168
	RPM	11406	8555	6844	5703	4277	3422	2737				
	FEED	3353	4312	4270	4277	3747	3326	2759				
14.1	Stainless steel	0.05D	3.0D	Vc	145	145	145	145	145	145	145	
				fz	0.041	0.071	0.088	0.105	0.123	0.137	0.143	
				RPM	7692	5769	4615	3846	2885	2308	1846	
14.2	Stainless steel	0.05D	3.0D	Vc	135	135	135	135	135	135	135	
				fz	0.041	0.071	0.088	0.105	0.123	0.137	0.142	
				RPM	7162	5371	4297	3581	2686	2149	1719	
K	15-20	Grey cast iron	0.05D	3.0D	Vc	225	225	225	225	225	225	225
					fz	0.082	0.139	0.173	0.208	0.242	0.270	0.278
					RPM	11937	8952	7162	5968	4476	3581	2865
					FEED	5844	7477	7426	7434	6510	5801	4785
S	31-35	Heat Resistant Super Alloys	0.05D	3.0D	Vc	35	35	35	35	35	35	35
					fz	0.033	0.055	0.070	0.082	0.097	0.112	0.115
					RPM	1857	1393	1114	928	696	557	446
					FEED	368	460	468	457	405	374	307
36-37	Titanium Alloys	0.05D	3.0D	Vc	115	115	115	115	115	115	115	
				fz	0.033	0.055	0.070	0.083	0.097	0.113	0.117	
				RPM	6101	4576	3661	3050	2288	1830	1464	
				FEED	1208	1510	1537	1519	1332	1241	1028	

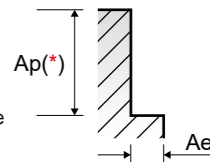

(*) : If product's Length of Cut(L.O.C) is below 2D, it must be applied with L.O.C x 90%

EMB72, EMB73 SERIES 5 FLUTE - SIDE CUTTING

Vc = m/min.
fz = mm/tooth
RPM = rev./min.
FEED = mm/min.

ISO	VDI 3323	Material Description	Ae	Ap	Parameter	Diameter (Ø)						
						6.0	8.0	10.0	12.0	14.0	16.0	20.0
P	1-2	Non-alloy steel	0.25D	1.25D	Vc	135	135	135	135	135	135	135
					fz	0.034	0.038	0.050	0.063	0.069	0.076	0.089
					RPM	7162	5371	4297	3581	3069	2686	2149
					FEED	1218	1021	1074	1128	1059	1021	956
					Vc	135	135	135	135	135	135	135
					fz	0.034	0.038	0.050	0.063	0.069	0.076	0.089
	6	High alloyed steel, and tool steel	0.25D	1.25D	Vc	135	135	135	135	135	135	135
					fz	0.034	0.038	0.050	0.063	0.069	0.076	0.089
					RPM	7162	5371	4297	3581	3069	2686	2149
					FEED	1218	1021	1074	1128	1059	1021	956
					Vc	135	135	135	135	135	135	135
					fz	0.034	0.038	0.050	0.063	0.069	0.076	0.089
10	High alloyed steel, and tool steel	0.25D	1.25D	Vc	105	105	105	145	105	105	105	
				fz	0.030	0.032	0.038	0.043	0.064	0.068	0.076	
				RPM	5570	4178	3342	3846	2387	2089	1671	
				FEED	836	668	635	827	764	710	635	
				Vc	115	115	115	115	115	115	115	
				fz	0.030	0.032	0.038	0.063	0.065	0.069	0.076	
M	14.1	Stainless steel	0.25D	1.25D	Vc	135	135	135	135	135	135	135
					fz	0.034	0.038	0.050	0.063	0.069	0.076	0.089
					RPM	7162	5371	4297	3581	3069	2686	2149
					FEED	1218	1021	1074	1128	1059	1021	956
					Vc	25	25	25	25	25	25	25
					fz	0.017	0.020	0.025	0.036	0.045	0.048	0.060
K	15-20	Grey cast iron	0.25D	1.25D	Vc	85	85	85	85	85	85	85
					fz	0.030	0.031	0.038	0.050	0.057	0.063	0.075
					RPM	4509	3382	2706	2255	1933	1691	1353
					FEED	676	524	514	564	551	533	507
					Vc	135	135	135	135	135	135	135
					fz	0.034	0.038	0.050	0.063	0.069	0.076	0.089
S	31-35	Heat Resistant Super Alloys	0.25D	1.0D	Vc	25	25	25	25	25	25	25
					fz	0.017	0.020	0.025	0.036	0.045	0.048	0.060
					RPM	1326	995	796	663	568	497	398
					FEED	113	99	99	119	128	119	119
					Vc	85	85	85	85	85	85	85
					fz	0.030	0.031	0.038	0.050	0.057	0.063	0.075
S	36-37	Titanium Alloys	0.25D	1.25D	Vc	85	85	85	85	85	85	85
					fz	0.030	0.031	0.038	0.050	0.057	0.063	0.075
					RPM	4509	3382	2706	2255	1933	1691	1353
					FEED	676	524	514	564	551	533	507
					Vc	25	25	25	25	25	25	25
					fz	0.017	0.020	0.025	0.036	0.045	0.048	0.060

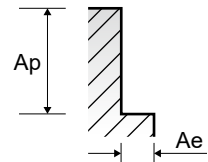



Leading Through Innovation

SOLID CARBIDE

ALU-POWER HPC END MILLS

Alu Power HPC VHM Fräser

- For Aluminium, Aluminum Die Cast, Non-ferrous Alloys and Plastics
- Für Aluminium, Aluminiumdruckguss, Nichteisenlegierungen und Kunststoffe

SELECTION GUIDE



SERIES	E5H24 JAH24	E5H25 JAH25	E5H22 JAH22	E5H23 JAH23
FLUTE	3	3	3	3
HELIX ANGLE	37°	37°	37°	37°
CUTTING EDGE SHAPE	CORNER RADIUS	CORNER RADIUS	SQUARE	SQUARE
SIZE MIN	D6.0	D6.0	D3.0	D6.0
SIZE MAX	D20.0	D20.0	D25.0	D20.0
PAGE	C444	C447	C450	C451

SOLID CARBIDE
ALU-POWER HPC
END MILLS

3-Flute, High-Performance,
For Aluminum, Aluminum Die Cast,
Non-Ferrous Alloys And Plastics

	E5H24 JAH24	E5H25 JAH25	E5H22 JAH22	E5H23 JAH23
	-	EXTENDED NECK	-	EXTENDED NECK
	Uncoated	Uncoated	Uncoated	Uncoated
	DLC	DLC	DLC	DLC



Please visit globalyg1.com/mat for material search

◎ : Excellent ○ : Good

Recommended cutting conditions : p. C452

ISO	VDI 3323	Material Description	Composition / Structure / Heat Treatment	HB	HRc				
P	1	Non-alloy steel	About 0.15% C Annealed	125					
	2		About 0.45% C Annealed	190	13				
	3		About 0.45% C Quenched & Tempered	250	25				
	4		About 0.75% C Annealed	270	28				
	5		About 0.75% C Quenched & Tempered	300	32				
	6	Low alloy steel	Annealed	180	10				
	7		Quenched & Tempered	275	29				
	8		Quenched & Tempered	300	32				
	9		Quenched & Tempered	350	38				
	10	High alloyed steel, and tool steel	Annealed	200	15				
	11		Quenched & Tempered	325	35				
M	12	Stainless steel	Ferritic / Martensitic Annealed	200	15				
	13		Martensitic Quenched & Tempered	240	23				
	14		Austenitic	180	10				
K	15	Grey cast iron	Pearlitic / ferritic	180	10				
	16		Pearlitic (Martensitic)	260	26				
	17	Nodular cast iron	Ferritic	160	3				
	18		Pearlitic	250	25				
	19	Malleable cast iron	Ferritic	130					
	20		Pearlitic	230	21				
N	21	Aluminum-wrought alloy	Not Curable	60		◎	◎	◎	◎
	22		Curable Hardened	100		◎	◎	◎	◎
	23	Aluminum-cast, alloyed	≤ 12% Si, Not Curable	75		◎	◎	◎	◎
	24		≤ 12% Si, Curable Hardened	90		◎	◎	◎	◎
	25		> 12% Si, Not Curable	130		○	○	○	○
	26	Copper and Copper Alloys (Bronze / Brass)	Cutting Alloys, PB>1%	110		○	○	○	○
	27		CuZn, CuSnZn (Brass)	90		○	○	○	○
	28		CuSn, lead-free copper and electrolytic copper	100		○	○	○	○
	29		Non Metallic Materials	Duroplastic, Fiber Reinforced Plastic Rubber, Wood, etc.			○	○	○
	30								
S	31	Heat Resistant Super Alloys	Fe Based	Annealed	200	15			
	32			Cured	280	30			
	33		Ni or Co Based	Annealed	250	25			
	34			Cured	350	38			
	35			Cast	320	34			
	36	Titanium Alloys	Pure Titanium	400 Rm					
37	Alpha + Beta Alloys		Hardened	1050 Rm					
H	38	Hardened steel	Hardened	550	55				
	39		Hardened	630	60				
	40	Chilled Cast Iron	Cast	400	42				
	41	Hardened Cast Iron	Hardened	550	55				

Scan QR Code to See Catalogue
AEROSPACE SOLUTIONS & COMPOSITE MATERIALS



ALU-POWER HPC END MILLS

UNCOATED E5H24 SERIES
DLC COATED JAH24 SERIES
PLAIN SHANK

CARBIDE, 3 FLUTE 37° HELIX CORNER RADIUS

- Vollhartmetall, 3 Schneiden 37° Eckradius
Fraise carbure, 3 dents, torique, hélice 37°
3 TAGLIENTI, ELICA 37°, SPIGOLO RAGGIATO

- Balanced cutting with less vibration
Ability to run at higher speeds with less heat in aluminum
More efficient chip evacuation
Ability to counteract extreme radial forces
DLC Coating provides edge strength and unsurpassed tool life

- Ausgewogenes Fräsen, mit weniger Vibrationen
Höhere Schnittgeschwindigkeiten möglich bei weniger Wärmeeinbringung in den Werkstoff Aluminium
Effizientere Spanabfuhr
Fähigkeit, extremen Radialkräften entgegenzuwirken
Die DLC-Beschichtung bietet Kantenfestigkeit und unübertroffene Standzeit

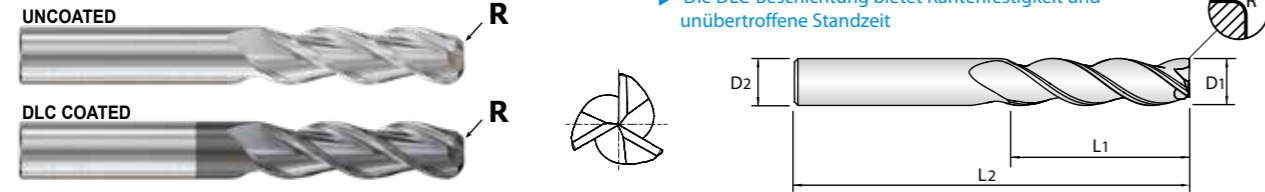

Table with 2 columns: Plain Shank, Page. Lists tool holders like Hydraulic Chuck, Shrink Fit Holder, Power Milling Chuck, ER Collet Chuck, SK Slim Chuck with corresponding page numbers.

Unit : mm

Main product table for E5H24 series with columns: EDP No., Corner Radius, Mill Diameter, Shank Diameter, Length of Cut, Overall Length.

Table with 2 columns: Mill Diameter Tolerances (mm), Shank Diameter Tolerance. Shows diameter ranges and tolerances.

© : Excellent ○ : Good

ISO material compatibility table for E5H24 series, categorized by P (Non-alloy steel), M (Stainless steel), K (Cast iron), N (Aluminum), S (Heat Resistant Super Alloys), and H (Titanium Alloys).

ALU-POWER HPC END MILLS

UNCOATED E5H25 SERIES
DLC COATED JAH25 SERIES
PLAIN SHANK

CARBIDE, 3 FLUTE 37° HELIX CORNER RADIUS with EXTENDED NECK

- Vollhartmetall, 3 Schneiden 37° Eckradius mit verlängertem Hals
Fraise carbure, 3 dents, torique, hélice 37°, détalonnée, extra-courte
3 TAGLIENTI, ELICA 37°, SPIGOLO RAGGIATO SCARICATA

- Balanced cutting with less vibration
Ability to run at higher speeds with less heat in aluminum
More efficient chip evacuation
Ability to counteract extreme radial forces
DLC Coating provides edge strength and unsurpassed tool life

- Ausgewogenes Fräsen, mit weniger Vibrationen
Höhere Schnittgeschwindigkeiten möglich bei weniger Wärmeeinbringung in den Werkstoff Aluminium
Effizientere Spanabfuhr
Fähigkeit, extremen Radialkräften entgegenzuwirken
Die DLC-Beschichtung bietet Kantenfestigkeit und unübertroffene Standzeit

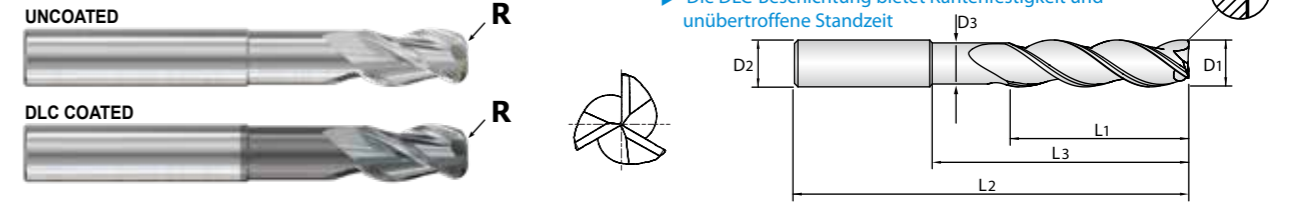

Table with 2 columns: Plain Shank, Page. Lists tool holders like Hydraulic Chuck, Shrink Fit Holder, Power Milling Chuck, ER Collet Chuck, SK Slim Chuck with corresponding page numbers.

Unit : mm

Main product table for E5H25 series with columns: EDP No., Corner Radius, Mill Diameter, Shank Diameter, Length of Cut, Length Below Shank, Overall Length, Neck Diameter.

Table with 2 columns: Mill Diameter Tolerances (mm), Shank Diameter Tolerance. Shows diameter ranges and tolerances.

NEXT PAGE

© : Excellent ○ : Good

ISO material compatibility table for E5H25 series, categorized by P (Non-alloy steel), M (Stainless steel), K (Cast iron), N (Aluminum), S (Heat Resistant Super Alloys), and H (Titanium Alloys).



Global Cutting Tool Leader **YG-1**



MILLING



Leading Through Innovation



SOLID CARBIDE

ALU-POWER END MILLS

Alu - Power Fräser

- For Aluminium Alloys and Silent Cutting
- Für Aluminiumlegierungen und geräuscharmen Schnitt

SELECTION GUIDE



SOLID CARBIDE
ALU POWER
END MILLS

Aluminium Alloys and Silent Cutting

Please visit globalyg1.com/mat for material search

◎ : Excellent ○ : Good

Recommended cutting conditions : p. C470

SERIES	E5910	E5908	E5909
FLUTE	2	3	2
HELIX ANGLE	50°	40°	30°
CUTTING EDGE SHAPE	BALL NOSE	BALL NOSE	CORNER RADIUS
SIZE MIN	R3.0	R1.0	D4.0
SIZE MAX	R10.0	R8.0	D20.0
PAGE	C458	C459	C460
	NECK	NECK	NECK
	Uncoated	Uncoated	Uncoated



ISO	VDI 3323	Material Description	Composition / Structure / Heat Treatment	HB	HRc
P	1	Non-alloy steel	About 0.15% C Annealed	125	
	2		About 0.45% C Annealed	190	13
	3		About 0.45% C Quenched & Tempered	250	25
	4		About 0.75% C Annealed	270	28
	5		About 0.75% C Quenched & Tempered	300	32
	6	Low alloy steel	Annealed	180	10
	7		Quenched & Tempered	275	29
	8		Quenched & Tempered	300	32
	9		Quenched & Tempered	350	38
	10		High alloyed steel, and tool steel	Annealed	200
	11	Quenched & Tempered		325	35
M	12	Stainless steel	Ferritic / Martensitic Annealed	200	15
	13		Martensitic Quenched & Tempered	240	23
	14		Austenitic	180	10
K	15	Grey cast iron	Pearlitic / ferritic	180	10
	16		Pearlitic (Martensitic)	260	26
	17	Nodular cast iron	Ferritic	160	3
	18		Pearlitic	250	25
	19	Malleable cast iron	Ferritic	130	
	20		Pearlitic	230	21
N	21	Aluminum-wrought alloy	Not Curable	60	
	22		Curable Hardened	100	
	23	Aluminum-cast, alloyed	≤ 12% Si, Not Curable	75	
	24		≤ 12% Si, Curable Hardened	90	
	25		> 12% Si, Not Curable	130	
	26		Copper and Copper Alloys (Bronze / Brass)	CuZn, CuSnZn (Brass)	90
	27	Non Metallic Materials	CuSn, lead-free copper and electrolytic copper	100	
	28		Duroplastic, Fiber Reinforced Plastic		
	29		Rubber, Wood, etc.		
	S	31	Heat Resistant Super Alloys	Fe Based Annealed	200
32		Cured		280	30
33		Annealed		250	25
34		Ni or Co Based Cured		350	38
35		Cast		320	34
36		Titanium Alloys	Pure Titanium	400 Rm	
37	Alpha + Beta Alloys	Hardened	1050 Rm		
H	38	Hardened steel	Hardened	550	55
	39		Hardened	630	60
	40	Chilled Cast Iron	Cast	400	42
	41	Hardened Cast Iron	Hardened	550	55

E5930	E5E51	E5E47	E5E48	E5522 E5521	E5E49	E5E50	E5742 E5711	E5E39 E5E40
2	3	1	2	2	3	3	3	3
25°	45°	30°	45°	45°	45°	45°	30°	30°
CORNER RADIUS	CORNER RADIUS	SQUARE	SQUARE	SQUARE	SQUARE	SQUARE	ROUGHING	ROUGHING
D2.0	D3.0	D2.0	D3.0	D3.0	D3.0	D3.0	D6.0	D6.0
D20.0	D20.0	D12.0	D20.0	D20.0	D20.0	D20.0	D25.0	D20.0
C461	C462	C463	C464	C465	C466	C467	C468	C469
NECK	LONG LENGTH	-	SHORT LENGTH	LONG LENGTH	LONG LENGTH	NECK	LONG LENGTH	NECK
Uncoated	Uncoated	Uncoated	Uncoated	Uncoated	Uncoated	Uncoated	Uncoated	Uncoated



ISO	VDI 3323	Material Description	Composition / Structure / Heat Treatment	HB	HRc
P	1	Non-alloy steel	About 0.15% C Annealed	125	
	2		About 0.45% C Annealed	190	13
	3		About 0.45% C Quenched & Tempered	250	25
	4		About 0.75% C Annealed	270	28
	5		About 0.75% C Quenched & Tempered	300	32
	6	Low alloy steel	Annealed	180	10
	7		Quenched & Tempered	275	29
	8		Quenched & Tempered	300	32
	9		Quenched & Tempered	350	38
	10		High alloyed steel, and tool steel	Annealed	200
	11	Quenched & Tempered		325	35
M	12	Stainless steel	Ferritic / Martensitic Annealed	200	15
	13		Martensitic Quenched & Tempered	240	23
	14		Austenitic	180	10
K	15	Grey cast iron	Pearlitic / ferritic	180	10
	16		Pearlitic (Martensitic)	260	26
	17	Nodular cast iron	Ferritic	160	3
	18		Pearlitic	250	25
	19	Malleable cast iron	Ferritic	130	
	20		Pearlitic	230	21
N	21	Aluminum-wrought alloy	Not Curable	60	
	22		Curable Hardened	100	
	23	Aluminum-cast, alloyed	≤ 12% Si, Not Curable	75	
	24		≤ 12% Si, Curable Hardened	90	
	25		> 12% Si, Not Curable	130	
	26		Copper and Copper Alloys (Bronze / Brass)	CuZn, CuSnZn (Brass)	90
	27	Non Metallic Materials	CuSn, lead-free copper and electrolytic copper	100	
	28		Duroplastic, Fiber Reinforced Plastic		
	29		Rubber, Wood, etc.		
	S	31	Heat Resistant Super Alloys	Fe Based Annealed	200
32		Cured		280	30
33		Annealed		250	25
34		Ni or Co Based Cured		350	38
35		Cast		320	34
36		Titanium Alloys	Pure Titanium	400 Rm	
37	Alpha + Beta Alloys	Hardened	1050 Rm		
H	38	Hardened steel	Hardened	550	55
	39		Hardened	630	60
	40	Chilled Cast Iron	Cast	400	42
	41	Hardened Cast Iron	Hardened	550	55

HSS

CBN END MILLS

i-Xmill END MILLS

i-SMART MODULAR TYPE END MILLS

X5070 END MILLS

4G MILL END MILLS

X-POWER PRO END MILLS

TitaNox-POWER END MILLS

JET-POWER END MILLS

V7 PLUS END MILLS

ALU-POWER HPC END MILLS

ALU-POWER END MILLS

D-POWER GRAPHITE END MILLS

CRX S END MILLS

K-2 END MILLS

ONLY ONE COATED PM60 END MILLS

TANK-POWER END MILLS

GENERAL HSS END MILLS

MILLING CUTTERS

TECHNICAL DATA

CARBIDE, 2 FLUTE 50° HELIX BALL NOSE with NECK

● VOLLHARTMETALL, 2 SCHNEIDEN 50° RECHTSSPIRALE STIRNRADIUS mit ABGESETZTEM SCHAFTTETEL
 (●) Fraise carbure, 2 dents, hémisphérique, hélice 50°, détalonnée
 (●) 2 TAGLIENTI, ELICA 50°, SEMISFERICA, SCARICATA

- ▶ Excellent cutting qualities on aluminum and copper
- ▶ Increased tool life and higher cutting accuracy
- ▶ Mirror surface - Excellent surface finish

- ▶ Ausgezeichnete Schneideigenschaften in Aluminium, Kupfer
- ▶ Verbesserte Standzeiten und höhere Fräsgenauigkeit.
- ▶ Spiegel-Oberfläche - Hervorragendes Oberflächenfinishing.

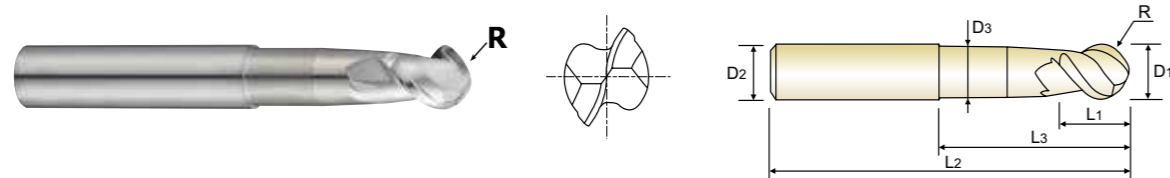

CARBIDE 2 50° R ±0.02 PLAIN UNCOATED p.C470

Flat Shank	Page	Plain Shank	Page
END MILL HOLDER	D118 - 137	HYDRAULIC CHUCK	D15 - 46
		SHRINK FIT HOLDER	D47 - 72
		POWER MILLING CHUCK	D161 - 176
		ER COLLET CHUCK	D73 - 116

Unit : mm

EDP No.	Radius of Ball Nose	Mill Diameter	Shank Diameter	Length of Cut		Overall Length	Neck Diameter
	R(±0.02)	D1	D2	L1	L3	L2	D3
E5910060	R3.0	6.0	6	5.5	25	55	5.4
E5910080	R4.0	8.0	8	7	30	65	7.2
E5910100	R5.0	10.0	10	8.5	35	75	9
E5910120	R6.0	12.0	12	10.5	40	75	11
E5910160	R8.0	16.0	16	14	50	90	14.5
E5910200	R10.0	20.0	20	17	50	100	18

▶ TiN, TiCN and TiAlN Coatings are available on your request.

Mill Dia. Tolerance(mm)	Shank Dia. Tolerance
± 0.02	h5

◎ : Excellent ○ : Good

ISO Material Description	P										M				K						
	Non-alloy steel					Low alloy steel					High alloyed steel, and tool steel				Stainless steel		Grey cast iron		Nodular cast iron	Malleable cast iron	
VDI 3323	1	2	3	4	5	6	7	8	9	10	11	12	13	14	15	16	17	18	19	20	
HRc	13	25	28	32	32	10	29	32	38	15	35	15	23	10	10	26	3	25	21	21	
HB	125	190	250	270	300	180	275	300	350	200	325	200	240	180	180	260	160	250	130	230	
Recommend	◎	◎	◎	◎	◎	◎	◎	◎	◎	◎	◎	◎	◎	◎	◎	◎	◎	◎	◎	◎	◎

ISO Material Description	N					S					H											
	Aluminum-wrought alloy		Aluminum-cast, alloyed			Copper and Copper Alloys (Bronze / Brass)			Non Metallic Materials		Heat Resistant Super Alloys					Titanium Alloys		Hardened steel	Chilled Cast Iron	Hardened Cast Iron		
VDI 3323	21	22	23	24	25	26	27	28	29	30	31	32	33	34	35	36	37	38	39	40	41	
HRc	21	22	23	24	25	26	27	28	29	30	31	32	33	34	35	36	37	38	39	40	41	
HB	60	100	75	90	130	110	90	100			200	280	250	350	320	400 Rm	1050 Rm	550	630	400	550	
Recommend	◎	◎	◎	◎	◎	◎	◎	◎	◎	◎	◎	◎	◎	◎	◎	◎	◎	◎	◎	◎	◎	◎

CARBIDE, 3 FLUTE 40° HELIX BALL NOSE with NECK

● VOLLHARTMETALL, 3 SCHNEIDEN 40° RECHTSSPIRALE STIRNRADIUS mit ABGESETZTEM SCHAFTTETEL
 (●) Fraise carbure, 3 dents, hémisphérique, hélice 40°, détalonnée
 (●) 3 TAGLIENTI, ELICA 40°, SEMISFERICA, SCARICATA

- ▶ Excellent cutting qualities on aluminum and copper
- ▶ Increased tool life and higher cutting accuracy
- ▶ Mirror surface - Excellent surface finish

- ▶ Ausgezeichnete Schneideigenschaften in Aluminium, Kupfer
- ▶ Verbesserte Standzeiten und höhere Fräsgenauigkeit.
- ▶ Spiegel-Oberfläche - Hervorragendes Oberflächenfinishing.

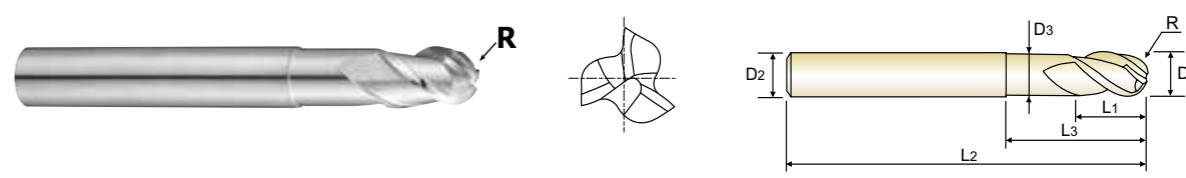

CARBIDE 3 40° R ±0.02 PLAIN UNCOATED p.C470

Flat Shank	Page	Plain Shank	Page
END MILL HOLDER	D118 - 137	HYDRAULIC CHUCK	D15 - 46
		SHRINK FIT HOLDER	D47 - 72
		POWER MILLING CHUCK	D161 - 176
		ER COLLET CHUCK	D73 - 116

Unit : mm

EDP No.	Radius of Ball Nose	Mill Diameter	Shank Diameter	Length of Cut	Length Below Shank	Overall Length	Neck Diameter
	R(±0.02)	D1	D2	L1	L3	L2	D3
E5908020	R1.0	2.0	6	3	5	60	1.9
E5908025	R1.25	2.5	6	4	6	60	2.4
E5908030	R1.5	3.0	6	4.5	6.5	60	2.8
E5908035	R1.75	3.5	6	5	7	65	3.2
E5908040	R2.0	4.0	6	6	8	65	3.7
E5908050	R2.5	5.0	6	7.5	10	65	4.6
E5908060	R3.0	6.0	6	9	12	75	5.6
E5908080	R4.0	8.0	8	12	25	75	7.4
E5908100	R5.0	10.0	10	15	30	80	9.4
E5908120	R6.0	12.0	12	18	36	90	11.4
E5908160	R8.0	16.0	16	24	40	100	15.4

▶ TiN, TiCN and TiAlN Coatings are available on your request.

Mill Dia. Tolerance(mm)	Shank Dia. Tolerance
0 ~ - 0.03	h5

◎ : Excellent ○ : Good

ISO Material Description	P										M				K						
	Non-alloy steel					Low alloy steel					High alloyed steel, and tool steel				Stainless steel		Grey cast iron		Nodular cast iron	Malleable cast iron	
VDI 3323	1	2	3	4	5	6	7	8	9	10	11	12	13	14	15	16	17	18	19	20	
HRc	13	25	28	32	32	10	29	32	38	15	35	15	23	10	10	26	3	25	21	21	
HB	125	190	250	270	300	180	275	300	350	200	325	200	240	180	180	260	160	250	130	230	
Recommend	◎	◎	◎	◎	◎	◎	◎	◎	◎	◎	◎	◎	◎	◎	◎	◎	◎	◎	◎	◎	◎

ISO Material Description	N					S					H											
	Aluminum-wrought alloy		Aluminum-cast, alloyed			Copper and Copper Alloys (Bronze / Brass)			Non Metallic Materials		Heat Resistant Super Alloys					Titanium Alloys		Hardened steel	Chilled Cast Iron	Hardened Cast Iron		
VDI 3323	21	22	23	24	25	26	27	28	29	30	31	32	33	34	35	36	37	38	39	40	41	
HRc	21	22	23	24	25	26	27	28	29	30	31	32	33	34	35	36	37	38	39	40	41	
HB	60	100	75	90	130	110	90	100			200	280	250	350	320	400 Rm	1050 Rm	550	630	400	550	
Recommend	◎	◎	◎	◎	◎	◎	◎	◎	◎	◎	◎	◎	◎	◎	◎	◎	◎	◎	◎	◎	◎	◎

CARBIDE, 2 FLUTE CORNER RADIUS with NECK

- VOLLHARTMETALL, 2 SCHNEIDEN ECKENRADIUS mit ABGESETZTEM SCHAFTTETL
- Fraise carbure, 2 dents, torique, détalonnée
- 2 TAGLIENTI, TORICA, SCARICATA

- ▶ Excellent cutting qualities on aluminum and copper
- ▶ Increased tool life and higher cutting accuracy
- ▶ Mirror surface - Excellent surface finish
- ▶ Superior chip evacuation
- ▶ Reduces chipping of corner edges

- ▶ Ausgezeichnete Schneideigenschaften in Aluminium, Kupfer
- ▶ Verbesserte Standzeiten und höhere Fräsgenauigkeit.
- ▶ Spiegel-Oberfläche - Hervorragendes Oberflächenfinishing.
- ▶ Überlegene Spanabfuhr
- ▶ Reduzierung von Schneideckenausbrüchen.

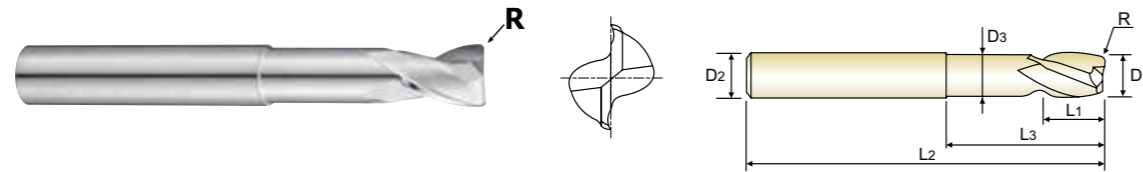

Flat Shank	Page	Plain Shank	Page
END MILL HOLDER	D118 - 137	HYDRAULIC CHUCK	D15 - 46
		SHRINK FIT HOLDER	D47 - 72
		POWER MILLING CHUCK	D161 - 176
		ER COLLET CHUCK	D73 - 116

Unit : mm

EDP No.	Corner Radius	Mill Diameter	Shank Diameter	Length of Cut	Length Below Shank	Overall Length	Neck Diameter
	R(±0.01)	D1	D2	L1	L3	L2	D3
E5909040	R0.3	4.0	6.0	5	10	50	3.6
E5909060	R0.5	6.0	6.0	8	20	60	5.4
E5909080	R0.6	8.0	8.0	10	30	70	7.2
E5909100	R0.8	10.0	10.0	12	36	80	9
E5909120	R1.0	12.0	12.0	14	40	90	11
E5909160	R1.3	16.0	16.0	18	45	100	14.5
E5909200	R1.6	20.0	20.0	24	45	100	18

▶ TIN, TiCN and TiAlN Coatings are available on your request.

Mill Dia. Tolerance(mm)	Shank Dia. Tolerance
0 ~ -0.03	h5

◎ : Excellent ○ : Good

ISO Material Description	P					M				K												
	Non-alloy steel					Low alloy steel				High alloyed steel, and tool steel		Stainless steel	Grey cast iron	Nodular cast iron	Malleable cast iron							
VDI 3323	1	2	3	4	5	6	7	8	9	10	11	12	13	14	15	16	17	18	19	20		
HRc	13	25	28	32	30	10	29	32	38	15	35	15	23	10	10	26	3	25	21	21		
HB	125	190	250	270	300	180	275	300	350	200	325	200	240	180	180	260	160	250	130	230		
Recommend	◎	◎	◎	◎	◎	◎	◎	◎	◎	◎	◎	◎	◎	◎	◎	◎	◎	◎	◎	◎	◎	
ISO Material Description	N				S						H											
	Aluminum-wrought alloy		Aluminum-cast, alloyed		Copper and Copper Alloys (Bronze / Brass)			Non Metallic Materials			Heat Resistant Super Alloys			Titanium Alloys	Hardened steel	Chilled Cast Iron	Hardened Cast Iron					
VDI 3323	21	22	23	24	25	26	27	28	29	30	31	32	33	34	35	36	37	38	39	40	41	
HRc	21	22	23	24	25	26	27	28	29	30	15	30	25	38	34	55	60	42	55	40	41	
HB	60	100	75	90	130	110	90	100			200	280	250	350	320	400 Rm	1050 Rm	550	630	400	550	
Recommend	◎	◎	◎	◎	◎	◎	◎	◎	◎	◎	◎	◎	◎	◎	◎	◎	◎	◎	◎	◎	◎	◎

CARBIDE, 2 FLUTE 25° HELIX CORNER RADIUS with NECK

- VOLLHARTMETALL, 2 SCHNEIDEN 25° RECHTSSPIRALE ECKENRADIUS mit ABGESETZTEM SCHAFTTETL
- Fraise carbure, 2 dents, torique, hélice 25°, détalonnée
- 2 TAGLIENTI, ELICA 25°, TORICA, SCARICATA

- ▶ Designed for machining aluminum, aluminum alloys and non-ferrous material
- ▶ Mirror surface - Excellent surface finish
- ▶ Increased tool life and higher cutting accuracy
- ▶ Maximum-metal removal rate
- ▶ Superior chip evacuation
- ▶ Corner Radius to avoid chipping problems

- ▶ Entwickelt für die Bearbeitung von Aluminium, Aluminiumlegierungen, NE-Metalle
- ▶ Spiegel-Oberfläche - Hervorragendes Oberflächenfinishing.
- ▶ Verbesserte Standzeiten und höhere Fräsgenauigkeit.
- ▶ Maximale Zerspanungsleistung.
- ▶ Überlegene Spanabfuhr
- ▶ Eckradien verhindern Schneidkantenausbrüche

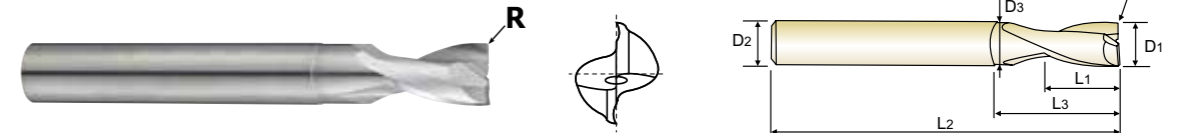

Flat Shank	Page	Plain Shank	Page
END MILL HOLDER	D118 - 137	HYDRAULIC CHUCK	D15 - 46
		SHRINK FIT HOLDER	D47 - 72
		POWER MILLING CHUCK	D161 - 176
		ER COLLET CHUCK	D73 - 116

Unit : mm

EDP No.	Corner Radius	Mill Diameter	Shank Diameter	Length of Cut	Length Below Shank	Overall Length	Neck Diameter
	R(±0.01)	D1	D2	L1	L3	L2	D3
E5930020	R0.2	2.0	3	3	6	40	1.9
E5930030	R0.2	3.0	3	4	8	40	2.9
E5930040	R0.2	4.0	4	5	12	50	3.8
E5930050	R0.2	5.0	5	8	14	50	4.8
E5930060	R0.2	6.0	6	8	18	65	5.7
E5930080	R0.2	8.0	8	10	22	70	7.7
E5930100	R0.2	10.0	10	14	28	80	9.7
E5930120	R0.2	12.0	12	16	35	90	11.5
E5930160	R0.2	16.0	16	20	40	90	15.5
E5930200	R0.2	20.0	20	25	50	100	19.5

▶ TIN, TiCN and TiAlN Coatings are available on your request.

Mill Dia. Tolerance(mm)	Shank Dia. Tolerance
0 ~ -0.03	h5

◎ : Excellent ○ : Good

ISO Material Description	P					M				K												
	Non-alloy steel					Low alloy steel				High alloyed steel, and tool steel		Stainless steel	Grey cast iron	Nodular cast iron	Malleable cast iron							
VDI 3323	1	2	3	4	5	6	7	8	9	10	11	12	13	14	15	16	17	18	19	20		
HRc	13	25	28	32	30	10	29	32	38	15	35	15	23	10	10	26	3	25	21	21		
HB	125	190	250	270	300	180	275	300	350	200	325	200	240	180	180	260	160	250	130	230		
Recommend	◎	◎	◎	◎	◎	◎	◎	◎	◎	◎	◎	◎	◎	◎	◎	◎	◎	◎	◎	◎	◎	
ISO Material Description	N				S						H											
	Aluminum-wrought alloy		Aluminum-cast, alloyed		Copper and Copper Alloys (Bronze / Brass)			Non Metallic Materials			Heat Resistant Super Alloys			Titanium Alloys	Hardened steel	Chilled Cast Iron	Hardened Cast Iron					
VDI 3323	21	22	23	24	25	26	27	28	29	30	31	32	33	34	35	36	37	38	39	40	41	
HRc	21	22	23	24	25	26	27	28	29	30	15	30	25	38	34	55	60	42	55	40	41	
HB	60	100	75	90	130	110	90	100			200	280	250	350	320	400 Rm	1050 Rm	550	630	400	550	
Recommend	◎	◎	◎	◎	◎	◎	◎	◎	◎	◎	◎	◎	◎	◎	◎	◎	◎	◎	◎	◎	◎	◎

CARBIDE, 3 FLUTE 45° HELIX LONG LENGTH CORNER RADIUS

● **VOLLHARTMETALL, 3 SCHNEIDEN 45° RECHTSSPIRALE LANG ECKENRADIUS**
 ○ **Fraise carbure, 3 dents, torique, hélice 45°, longue**
 ◎ **3 TAGLIENTI, ELICA 45°, TORICA, SERIE LUNGA**

- ▶ Excellent cutting qualities on aluminum and copper
- ▶ Increased tool life and higher cutting accuracy
- ▶ Mirror surface - Excellent surface finish
- ▶ Superior chip evacuation
- ▶ Reduces chipping of corner edges

- ▶ Ausgezeichnete Schneideigenschaften in Aluminium, Kupfer
- ▶ Verbesserte Standzeiten und höhere Fräsengenauigkeit.
- ▶ Spiegel-Oberfläche - Hervorragendes Oberflächenfinishing.
- ▶ Überlegene Spanabfuhr
- ▶ Reduzierung von Schneideckenausbrüchen.

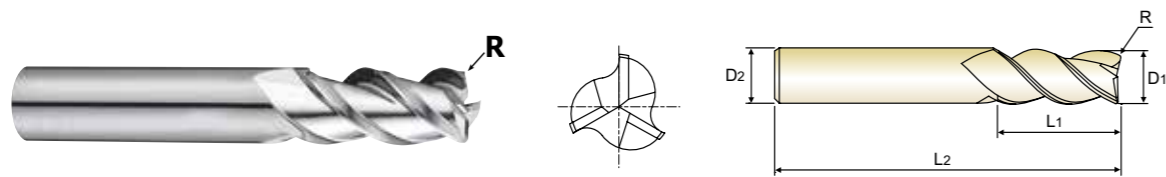

	Flat Shank	Page	Plain Shank	Page
⊙	END MILL HOLDER	D118 - 137	HYDRAULIC CHUCK	D15 - 46
⊙			SHRINK FIT HOLDER	D47 - 72
⊙			POWER MILLING CHUCK	D161 - 176
⊙			ER COLLET CHUCK	D73 - 116

Unit : mm

EDP No.	Corner Radius	Mill Diameter	Shank Diameter	Length of Cut	Overall Length
	R	D1	D2	L1	L2
E5E51030	R0.5	3.0	6	12	57
E5E51901	R1.0	3.0	6	12	57
E5E51040	R0.5	4.0	6	15	57
E5E51902	R1.0	4.0	6	15	57
E5E51050	R0.5	5.0	6	20	57
E5E51903	R1.0	5.0	6	20	57
E5E51060	R0.5	6.0	6	20	65
E5E51904	R1.0	6.0	6	20	65
E5E51080	R0.5	8.0	8	22	65
E5E51905	R1.0	8.0	8	22	65
E5E51100	R0.5	10.0	10	25	70
E5E51906	R1.0	10.0	10	25	70
E5E51907	R2.0	10.0	10	25	70
E5E51120	R0.5	12.0	12	25	75
E5E51908	R1.0	12.0	12	25	75
E5E51909	R2.0	12.0	12	25	75
E5E51160	R0.5	16.0	16	35	90
E5E51910	R1.0	16.0	16	35	90
E5E51911	R2.0	16.0	16	35	90
E5E51200	R0.5	20.0	20	40	100
E5E51912	R1.0	20.0	20	40	100
E5E51913	R2.0	20.0	20	40	100

▶ **TiN, TiCN and TiAlN Coatings are available on your request.**

Mill Dia. Tolerance(mm)	Shank Dia. Tolerance
0 ~ -0.015	h5

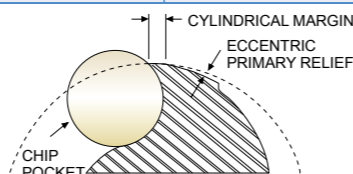

◎ : Excellent ○ : Good

ISO Material Description	P										M				K					
	Non-alloy steel					Low alloy steel					High alloyed steel, and tool steel		Stainless steel		Grey cast iron	Nodular cast iron	Malleable cast iron			
VDI 3323	1	2	3	4	5	6	7	8	9	10	11	12	13	14	15	16	17	18	19	20
HRc																				
HB	125	190	250	270	300	32	10	29	32	38	15	35	15	23	10	10	26	3	25	21
Recommend																				

ISO Material Description	N					S					H											
	Aluminum-wrought alloy		Aluminum-cast, alloyed			Copper and Copper Alloys (Bronze / Brass)		Non Metallic Materials		Heat Resistant Super Alloys			Titanium Alloys	Hardened steel	Chilled Cast Iron	Hardened Cast Iron						
VDI 3323	21	22	23	24	25	26	27	28	29	30	31	32	33	34	35	36	37	38	39	40	41	
HRc																						
HB	60	100	75	90	130	110	90	100														
Recommend	◎	◎	◎	◎	○																	

CARBIDE, 1 FLUTE

● **VOLLHARTMETALL, 1 SCHNEIDEN**
 ○ **Fraise carbure, 1 dent**
 ◎ **1 TAGLIENTE**

- ▶ Designed for non-ferrous material, non-metal like aluminum and acrylic
- ▶ 1 Flute allows excellent finished workpiece and chip evacuation

- ▶ Entwickelt für NE-Metalle und nichtmetallische Werkstoffe wie Aluminium und Acryl
- ▶ 1 Spannfute ermöglicht hervorragende Werkstückoberflächen und Spanabfuhr

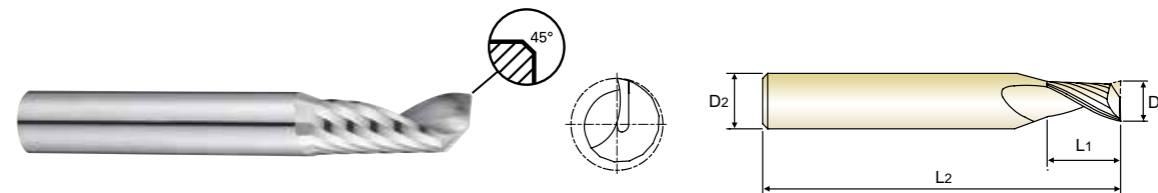

	Flat Shank	Page	Plain Shank	Page
⊙	END MILL HOLDER	D118 - 137	HYDRAULIC CHUCK	D15 - 46
⊙			SHRINK FIT HOLDER	D47 - 72
⊙			POWER MILLING CHUCK	D161 - 176
⊙			ER COLLET CHUCK	D73 - 116

Unit : mm

EDP No.	Mill Diameter	Shank Diameter	Length of Cut	Overall Length	Chamfer
	D1	D2	L1	L2	
E5E47020	2.0	3	8	50	0.04
E5E47030	3.0	3	12	50	0.05
E5E47040	4.0	4	15	60	0.07
E5E47050	5.0	5	17	60	0.09
E5E47060	6.0	6	20	65	0.10
E5E47080	8.0	8	22	65	0.14
E5E47100	10.0	10	25	75	0.14
E5E47120	12.0	12	30	80	0.14

▶ **TiN, TiCN and TiAlN Coatings are available on your request.**

Mill Dia. Tolerance(mm)	Shank Dia. Tolerance
0 ~ -0.03	h5

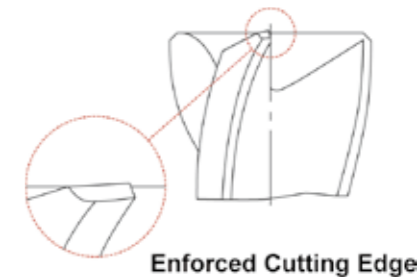

◎ : Excellent ○ : Good

ISO Material Description	P										M				K					
	Non-alloy steel					Low alloy steel					High alloyed steel, and tool steel		Stainless steel		Grey cast iron	Nodular cast iron	Malleable cast iron			
VDI 3323	1	2	3	4	5	6	7	8	9	10	11	12	13	14	15	16	17	18	19	20
HRc																				
HB	125	190	250	270	300	32	10	29	32	38	15	35	15	23	10	10	26	3	25	21
Recommend																				

ISO Material Description	N					S					H											
	Aluminum-wrought alloy		Aluminum-cast, alloyed			Copper and Copper Alloys (Bronze / Brass)		Non Metallic Materials		Heat Resistant Super Alloys			Titanium Alloys	Hardened steel	Chilled Cast Iron	Hardened Cast Iron						
VDI 3323	21	22	23	24	25	26	27	28	29	30	31	32	33	34	35	36	37	38	39	40	41	
HRc																						
HB	60	100	75	90	130	110	90	100														
Recommend	◎	◎	◎	◎	○					◎												

CARBIDE, 2 FLUTE 45° HELIX SHORT LENGTH

- VOLLHARTMETALL, 2 SCHNEIDEN 45° RECHTSSPIRALE KURZ
- Fraise carbure, 2 dents, hélice 45°, courte
- 2 TAGLIENTI, ELICA 45°, SERIE CORTA

- ▶ Suitable for high speed machining in aluminum and other non-ferrous materials
- ▶ Mirror surface - Excellent surface finish
- ▶ Superior chip evacuation

- ▶ Zur HSC- Bearbeitung von Aluminium und anderen Nichteisenmetallen.
- ▶ Spiegel-Oberfläche - Hervorragendes Oberflächenfinishing.
- ▶ Überlegene Spanabfuhr

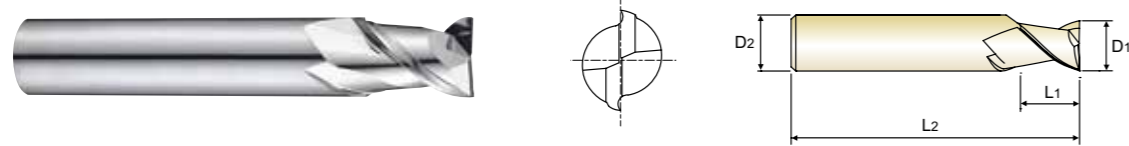

CARBIDE 2 45° PLAIN UNCOATED p.C472

Flat Shank	Page	Plain Shank	Page
END MILL HOLDER	D118-137	HYDRAULIC CHUCK	D15-46
		SHRINK FIT HOLDER	D47-72
		POWER MILLING CHUCK	D161-176
		ER COLLET CHUCK	D73-116

Unit : mm

EDP No.	Mill Diameter	Shank Diameter	Length of Cut	Overall Length
	D1	D2	L1	L2
E5E48030	3.0	6	5	50
E5E48040	4.0	6	8	54
E5E48050	5.0	6	9	54
E5E48060	6.0	6	10	54
E5E48080	8.0	8	12	58
E5E48100	10.0	10	14	66
E5E48120	12.0	12	16	73
E5E48140	14.0	14	18	75
E5E48160	16.0	16	22	82
E5E48180	18.0	18	24	84
E5E48200	20.0	20	26	92

▶ TIN, TiCN and TiAlN Coatings are available on your request.

Mill Dia. Tolerance(mm)	Shank Dia. Tolerance
0 ~ -0.015	h5

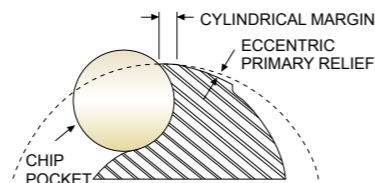

Enforced Cutting Edge

◎ : Excellent ○ : Good

ISO Material Description	P									M						K					
	Non-alloy steel			Low alloy steel			High alloyed steel, and tool steel			Stainless steel			Grey cast iron		Nodular cast iron		Malleable cast iron				
VDI 3323	1	2	3	4	5	6	7	8	9	10	11	12	13	14	15	16	17	18	19	20	
HRc	13	25	28	32	32	10	29	32	38	15	35	15	23	10	10	26	3	25	21	21	
HB	125	190	250	270	300	180	275	300	350	200	325	200	240	180	180	260	160	250	130	230	
Recommend																					
ISO Material Description	N						S						H								
	Aluminum-wrought alloy		Aluminum-cast, alloyed		Copper and Copper Alloys (Bronze / Brass)		Non Metallic Materials			Heat Resistant Super Alloys			Titanium Alloys		Hardened steel	Chilled Cast Iron	Hardened Cast Iron				
VDI 3323	21	22	23	24	25	26	27	28	29	30	31	32	33	34	35	36	37	38	39	40	41
HRc	15	30	25	38	34						200	280	250	350	320	400 Rm	1050 Rm	550	630	400	550
HB	60	100	75	90	130	110	90	100													
Recommend	◎	◎	◎	◎	○																

CARBIDE, 2 FLUTE 45° HELIX LONG LENGTH

- VOLLHARTMETALL, 2 SCHNEIDEN 45° RECHTSSPIRALE LANG
- Fraise carbure, 2 dents, hélice 45°, longue
- 2 TAGLIENTI, ELICA 45°, SERIE LUNGA

- ▶ Suitable for high speed machining in aluminum and other non-ferrous materials
- ▶ Mirror surface - Excellent surface finish
- ▶ Superior chip evacuation
- ▶ Reduces chipping of corner edges

- ▶ Zur HSC- Bearbeitung von Aluminium und anderen Nichteisenmetallen.
- ▶ Spiegel-Oberfläche - Hervorragendes Oberflächenfinishing.
- ▶ Überlegene Spanabfuhr
- ▶ Reduzierung von Schneideckenausbrüchen.

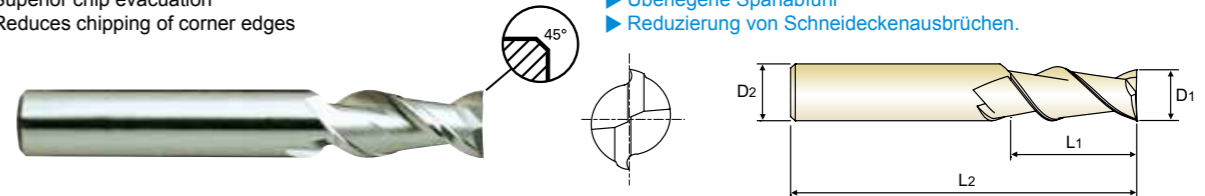

CARBIDE 2 45° PLAIN FLAT UNCOATED C x 45° p.C472

Flat Shank	Page	Plain Shank	Page
END MILL HOLDER	D118-137	HYDRAULIC CHUCK	D15-46
		SHRINK FIT HOLDER	D47-72
		POWER MILLING CHUCK	D161-176
		ER COLLET CHUCK	D73-116

Unit : mm

EDP No.	Mill Diameter	Shank Diameter	Length of Cut	Overall length	Chamfer	
						PLAIN
E5522030	E5521030	3.0	6	8	57	0.05
E5522040	E5521040	4.0	6	11	57	0.05
E5522050	E5521050	5.0	6	13	57	0.05
E5522060	E5521060	6.0	6	13	57	0.05
E5522080	E5521080	8.0	8	19	63	0.05
E5522100	E5521100	10.0	10	22	72	0.10
E5522120	E5521120	12.0	12	26	83	0.10
E5522140	E5521140	14.0	14	26	83	0.10
E5522160	E5521160	16.0	16	32	92	0.10
E5522180	E5521180	18.0	18	32	92	0.10
E5522200	E5521200	20.0	20	38	104	0.10

▶ TIN, TiCN and TiAlN Coatings are available on your request.

Mill Dia. Tolerance(mm)	Shank Dia. Tolerance
0 ~ -0.015	h5

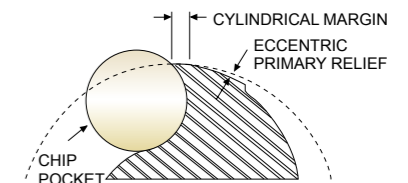

Enforced Cutting Edge

◎ : Excellent ○ : Good

ISO Material Description	P									M						K					
	Non-alloy steel			Low alloy steel			High alloyed steel, and tool steel			Stainless steel			Grey cast iron		Nodular cast iron		Malleable cast iron				
VDI 3323	1	2	3	4	5	6	7	8	9	10	11	12	13	14	15	16	17	18	19	20	
HRc	13	25	28	32	32	10	29	32	38	15	35	15	23	10	10	26	3	25	21	21	
HB	125	190	250	270	300	180	275	300	350	200	325	200	240	180	180	260	160	250	130	230	
Recommend																					
ISO Material Description	N						S						H								
	Aluminum-wrought alloy		Aluminum-cast, alloyed		Copper and Copper Alloys (Bronze / Brass)		Non Metallic Materials			Heat Resistant Super Alloys			Titanium Alloys		Hardened steel	Chilled Cast Iron	Hardened Cast Iron				
VDI 3323	21	22	23	24	25	26	27	28	29	30	31	32	33	34	35	36	37	38	39	40	41
HRc	15	30	25	38	34						200	280	250	350	320	400 Rm	1050 Rm	550	630	400	550
HB	60	100	75	90	130	110	90	100													
Recommend	◎	◎	◎	◎	○																

CARBIDE, 3 FLUTE 45° HELIX LONG LENGTH

● **VOLLHARTMETALL, 3 SCHNEIDEN 45° RECHTSSPIRALE LANG**
 (●) **Fraise carbure, 3 dents, hélice 45°, longue**
 (●) **3 TAGLIENTI, ELICA 45°, SERIE LUNGA**

- ▶ Excellent cutting qualities on aluminum and copper
- ▶ Increased tool life and higher cutting accuracy
- ▶ Mirror surface - Excellent surface finish
- ▶ Superior chip evacuation

- ▶ Ausgezeichnete Schneideigenschaften in Aluminium, Kupfer
- ▶ Verbesserte Standzeiten und höhere Fräsgenauigkeit
- ▶ Spiegel-Oberfläche - Hervorragendes Oberflächenfinishing
- ▶ Überlegene Spanabfuhr

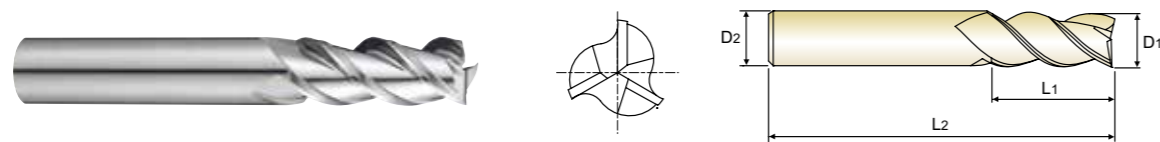

CARBIDE 3 45° PLAIN UNCOATED p.C473

Flat Shank	Page	Plain Shank	Page
END MILL HOLDER	D118 - 137	HYDRAULIC CHUCK	D15 - 46
		SHRINK FIT HOLDER	D47 - 72
		POWER MILLING CHUCK	D161 - 176
		ER COLLET CHUCK	D73 - 116

Unit : mm

EDP No.	Mill Diameter D1	Shank Diameter D2	Length of Cut L1	Overall Length L2
E5E49030	3.0	6	12	57
E5E49040	4.0	6	15	57
E5E49050	5.0	6	20	57
E5E49060	6.0	6	20	65
E5E49080	8.0	8	22	65
E5E49100	10.0	10	25	70
E5E49120	12.0	12	25	75
E5E49160	16.0	16	35	90
E5E49200	20.0	20	40	100

▶ TiN, TiCN and TiAlN Coatings are available on your request.

Mill Dia. Tolerance(mm)	Shank Dia. Tolerance
0 ~ -0.015	h5

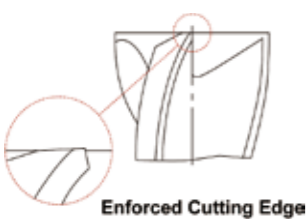
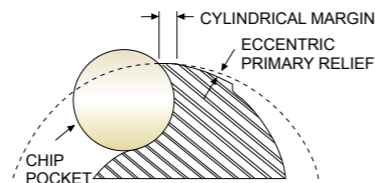

◎ : Excellent ○ : Good

ISO Material Description	P									M					K						
	Non-alloy steel			Low alloy steel			High alloyed steel, and tool steel			Stainless steel		Grey cast iron	Nodular cast iron		Malleable cast iron						
VDI 3323	1	2	3	4	5	6	7	8	9	10	11	12	13	14	15	16	17	18	19	20	
HRc	13	25	28	32	30	10	29	32	38	15	35	15	23	10	10	26	3	25	21	21	
HB	125	190	250	270	300	180	275	300	350	200	325	200	240	180	180	260	160	250	130	230	
Recommend																					

ISO Material Description	N					S					H										
	Aluminum-wrought alloy		Aluminum-cast, alloyed		Copper and Copper Alloys (Bronze / Brass)	Non Metallic Materials		Heat Resistant Super Alloys			Titanium Alloys		Hardened steel	Chilled Cast Iron	Hardened Cast Iron						
VDI 3323	21	22	23	24	25	26	27	28	29	30	31	32	33	34	35	36	37	38	39	40	41
HRc																					
HB	60	100	75	90	130	110	90	100			200	280	250	350	320	400 Rm	1050 Rm	550	630	400	550
Recommend	◎	◎	◎	◎	○																

CARBIDE, 3 FLUTE 45° HELIX with NECK

● **VOLLHARTMETALL, 3 SCHNEIDEN 45° RECHTSSPIRALE mit ABGESETZTEM SCHAFTTETEL**
 (●) **Fraise carbure, 3 dents, hélice 45°, détalonnée**
 (●) **3 TAGLIENTI, ELICA 45°, SCARICATA**

- ▶ Excellent cutting qualities on aluminum and copper
- ▶ Increased tool life and higher cutting accuracy
- ▶ Mirror surface - Excellent surface finish
- ▶ Superior chip evacuation

- ▶ Ausgezeichnete Schneideigenschaften in Aluminium, Kupfer
- ▶ Verbesserte Standzeiten und höhere Fräsgenauigkeit
- ▶ Spiegel-Oberfläche - Hervorragendes Oberflächenfinishing
- ▶ Überlegene Spanabfuhr

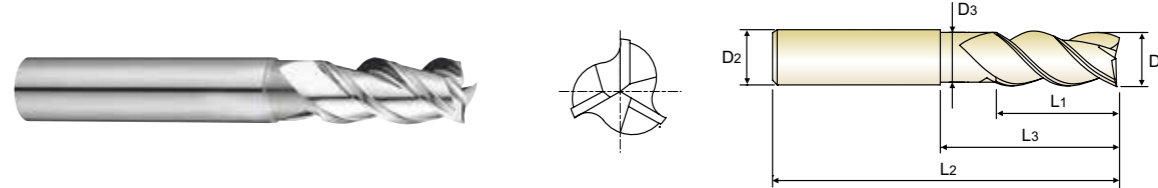

CARBIDE 3 45° PLAIN UNCOATED p.C473

Flat Shank	Page	Plain Shank	Page
END MILL HOLDER	D118 - 137	HYDRAULIC CHUCK	D15 - 46
		SHRINK FIT HOLDER	D47 - 72
		POWER MILLING CHUCK	D161 - 176
		ER COLLET CHUCK	D73 - 116

Unit : mm

EDP No.	Mill Diameter D1	Shank Diameter D2	Length of Cut L1	Length Below Shank L3	Overall Length L2	Neck Diameter D3
E5E50030	3.0	6	8	12	57	2.7
E5E50040	4.0	6	11	18	57	3.7
E5E50050	5.0	6	13	18	57	4.7
E5E50060	6.0	6	13	18	57	5.7
E5E50080	8.0	8	21	25	63	7.4
E5E50100	10.0	10	22	30	72	9.2
E5E50120	12.0	12	26	36	83	11
E5E50160	16.0	16	36	42	92	15
E5E50200	20.0	20	41	52	104	19

▶ TiN, TiCN and TiAlN Coatings are available on your request.

Mill Dia. Tolerance(mm)	Shank Dia. Tolerance
0 ~ -0.015	h5

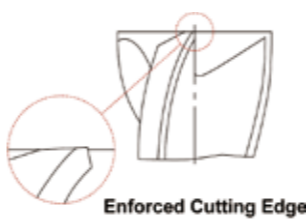
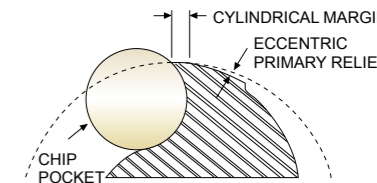

◎ : Excellent ○ : Good

ISO Material Description	P									M					K						
	Non-alloy steel			Low alloy steel			High alloyed steel, and tool steel			Stainless steel		Grey cast iron	Nodular cast iron		Malleable cast iron						
VDI 3323	1	2	3	4	5	6	7	8	9	10	11	12	13	14	15	16	17	18	19	20	
HRc	13	25	28	32	30	10	29	32	38	15	35	15	23	10	10	26	3	25	21	21	
HB	125	190	250	270	300	180	275	300	350	200	325	200	240	180	180	260	160	250	130	230	
Recommend																					

ISO Material Description	N					S					H										
	Aluminum-wrought alloy		Aluminum-cast, alloyed		Copper and Copper Alloys (Bronze / Brass)	Non Metallic Materials		Heat Resistant Super Alloys			Titanium Alloys		Hardened steel	Chilled Cast Iron	Hardened Cast Iron						
VDI 3323	21	22	23	24	25	26	27	28	29	30	31	32	33	34	35	36	37	38	39	40	41
HRc																					
HB	60	100	75	90	130	110	90	100			200	280	250	350	320	400 Rm	1050 Rm	550	630	400	550
Recommend	◎	◎	◎	◎	○																



PLAIN SHANK **E5742** SERIES
 FLAT SHANK **E5711** SERIES

CARBIDE, 3 FLUTE LONG LENGTH ROUGHING

● VOLLHARTMETALL, 3 SCHNEIDEN LANG SCHRUPPFÄSER
 (●) Fraise carbure, 3 dents, ébauche, longue
 (●) 3 TAGLIENTI, PER SGROSSATURA, SERIE LUNGA

- ▶ Excellent cutting qualities on aluminum and copper
- ▶ Increased tool life and higher cutting accuracy
- ▶ Mirror surface - Excellent surface finish

- ▶ Ausgezeichnete Schneideigenschaften in Aluminium, Kupfer
- ▶ Verbesserte Standzeiten und höhere Fräsgenauigkeit.
- ▶ Spiegel-Oberfläche - Hervorragendes Oberflächenfinishing.

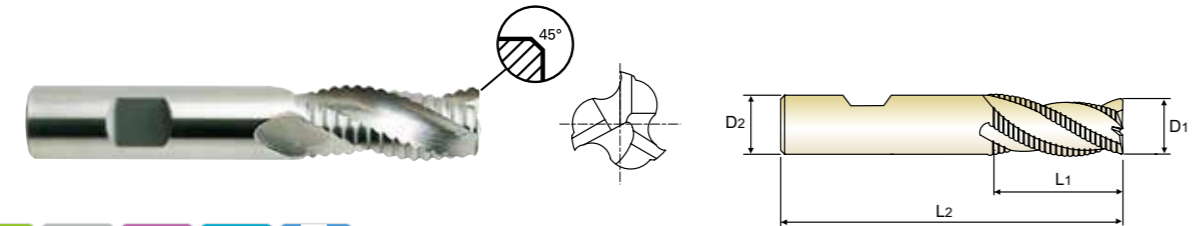

CARBIDE YG STD WR 3 30°
 UNCOATED p.C473

Flat Shank	Page	Plain Shank	Page
END MILL HOLDER	D118-137	HYDRAULIC CHUCK	D15-46
		SHRINK FIT HOLDER	D47-72
		POWER MILLING CHUCK	D161-176
		ER COLLET CHUCK	D73-116

Unit : mm

EDP No.	Mill Diameter		Shank Diameter		Length of Cut		Overall length		Chamfer
	PLAIN	FLAT	D1	D2	L1	L2	L2		
E5742060	E5711060	6.0	6	16	57	0.60			
E5742070	E5711070	7.0	8	16	63	0.60			
E5742080	E5711080	8.0	8	16	63	0.60			
E5742090	E5711090	9.0	10	19	72	0.60			
E5742100	E5711100	10.0	10	22	72	0.60			
E5742120	E5711120	12.0	12	26	83	0.60			
E5742140	E5711140	14.0	14	26	83	0.91			
E5742160	E5711160	16.0	16	32	92	0.91			
E5742180	E5711180	18.0	18	32	92	0.91			
E5742200	E5711200	20.0	20	38	104	0.91			
E5742250	E5711250	25.0	25	45	121	0.91			

▶ TIN, TiCN and TiAlN Coatings are available on your request.

Tolerances according to DIN 7160 & 7161

	Tolerance range in μm				
	Nominal-Diameter in mm				
	from 1 to 3	over 3 to 6	over 6 to 10	over 10 to 18	over 18 to 30
h10	0 -40	0 -48	0 -58	0 -70	0 -84
h5	0 -4	0 -5	0 -6	0 -8	0 -9

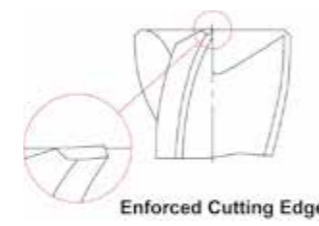

◎ : Excellent ○ : Good

ISO Material Description	P										M				K					
	Non-alloy steel					Low alloy steel					High alloyed steel, and tool steel		Stainless steel		Grey cast iron	Nodular cast iron		Malleable cast iron		
VDI 3323	1	2	3	4	5	6	7	8	9	10	11	12	13	14	15	16	17	18	19	20
HRc	13	25	28	32	35	38	42	45	48	52	55	58	62	65	68	72	75	78	82	85
HB	125	190	250	270	300	180	275	300	350	200	325	200	240	180	180	260	160	250	130	230
Recommend	○	○	○	○	○	○	○	○	○	○	○	○	○	○	○	○	○	○	○	○



PLAIN SHANK **E5E39** SERIES
 FLAT SHANK **E5E40** SERIES

CARBIDE, 3 FLUTE ROUGHING with NECK

● VOLLHARTMETALL, 3 SCHNEIDEN SCHRUPPFÄSER mit ABGESETZTEM SCHAFTTETL
 (●) Fraise carbure, 3 dents, ébauche détalonnée
 (●) 3 TAGLIENTI, PER SGROSSATURA, SCARICATA

- ▶ Excellent cutting qualities on aluminum and copper
- ▶ Increased tool life and higher cutting accuracy
- ▶ Mirror surface - Excellent surface finish

- ▶ Ausgezeichnete Schneideigenschaften in Aluminium, Kupfer
- ▶ Verbesserte Standzeiten und höhere Fräsgenauigkeit.
- ▶ Spiegel-Oberfläche - Hervorragendes Oberflächenfinishing.

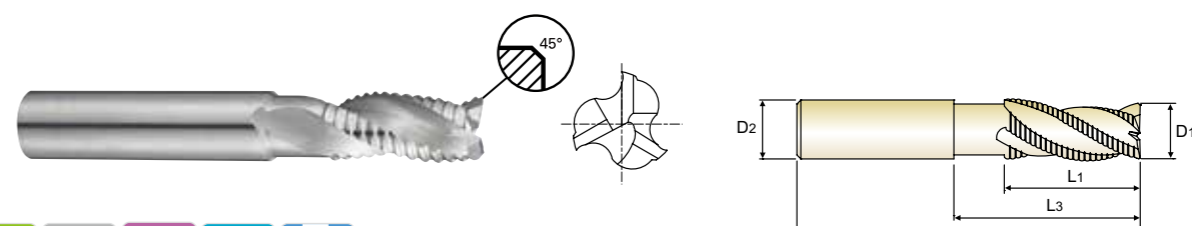

CARBIDE YG STD WR 3 30°
 UNCOATED p.C473

Flat Shank	Page	Plain Shank	Page
END MILL HOLDER	D118-137	HYDRAULIC CHUCK	D15-46
		SHRINK FIT HOLDER	D47-72
		POWER MILLING CHUCK	D161-176
		ER COLLET CHUCK	D73-116

Unit : mm

EDP No.	Mill Diameter		Shank Diameter		Length of Cut		Length Below Shank		Overall length		Neck Diameter		Chamfer
	PLAIN	FLAT	D1	D2	L1	L3	L2	L2	D3	D3	D3		
E5E39060	E5E40060	6.0	6	16	20	57	5	0.60					
E5E39080	E5E40080	8.0	8	16	25	63	7	0.60					
E5E39100	E5E40100	10.0	10	22	30	72	9	0.60					
E5E39120	E5E40120	12.0	12	26	36	83	10.5	0.60					
E5E39160	E5E40160	16.0	16	32	42	92	14.5	0.91					
E5E39200	E5E40200	20.0	20	38	52	104	18.5	0.91					

▶ TIN, TiCN and TiAlN Coatings are available on your request.

Tolerances according to DIN 7160 & 7161

	Tolerance range in μm				
	Nominal-Diameter in mm				
	from 1 to 3	over 3 to 6	over 6 to 10	over 10 to 18	over 18 to 30
h10	0 -40	0 -48	0 -58	0 -70	0 -84
h5	0 -4	0 -5	0 -6	0 -8	0 -9

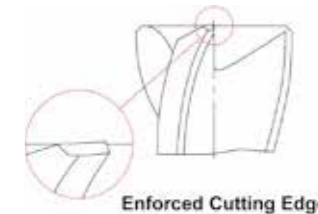

◎ : Excellent ○ : Good

ISO Material Description	P										M				K					
	Non-alloy steel					Low alloy steel					High alloyed steel, and tool steel		Stainless steel		Grey cast iron	Nodular cast iron		Malleable cast iron		
VDI 3323	1	2	3	4	5	6	7	8	9	10	11	12	13	14	15	16	17	18	19	20
HRc	13	25	28	32	35	38	42	45	48	52	55	58	62	65	68	72	75	78	82	85
HB	125	190	250	270	300	180	275	300	350	200	325	200	240	180	180	260	160	250	130	230
Recommend	○	○	○	○	○	○	○	○	○	○	○	○	○	○	○	○	○	○	○	○



Global Cutting Tool Leader **YG-1**



MILLING



Leading Through Innovation



SOLID CARBIDE

D-POWER GRAPHITE END MILLS

D - POWER Graphit VHM - Fräser

- For Graphites
- Für Graphite

SELECTION GUIDE



SOLID CARBIDE D-POWER for GRAPHITE END MILLS

High performance on graphite

Please visit globalyg1.com/mat for material search

◎: Excellent ○: Good

Recommended cutting conditions : p. C493

Table with 6 columns: ISO, VDI 3323, Material Description, Composition / Structure / Heat Treatment, HB, HRc. Rows include P (Non-alloy steel, Low alloy steel, High alloyed steel), M (Stainless steel), K (Grey cast iron, Nodular cast iron, Malleable cast iron), N (Aluminum-wrought alloy, Aluminum-cast alloyed, Copper and Copper Alloys, Non Metallic Materials), S (Heat Resistant Super Alloys, Titanium Alloys), and H (Hardened steel, Chilled Cast Iron, Hardened Cast Iron).

Series comparison table for EI997, EIB93, and EI880. Columns include FLUTE (2), HELIX ANGLE (30°), CUTTING EDGE SHAPE (BALL NOSE), SIZE MIN (R0.1, R0.2, R1.0), SIZE MAX (R3.0, R2.0, R6.0), PAGE (C478, C480, C481), and Neck types (MINIATURE NECK, SHORT LENGTH NECK).



Series comparison table for EI451, EI450, EIB87, EI881, EI996, EIB86, EIA13, EIA14, EIB88, and EIB04. Columns include FLUTE (2, 3), HELIX ANGLE (30°, 40°), CUTTING EDGE SHAPE (BALL NOSE, CORNER RADIUS, SQUARE), SIZE MIN (R1.0, D0.2, D2.0, D12.0), SIZE MAX (R6.0, D6.0, D12.0, D12.0), PAGE (C482, C483, C484, C485, C486, C488, C489, C490, C491, C492), and Neck types (LONG LENGTH NECK, LONG REACH NECK, TAPER NECK, MINIATURE NECK, TAPER NECK, SHORT LENGTH, LONG LENGTH, NECK, LONG LENGTH NECK).

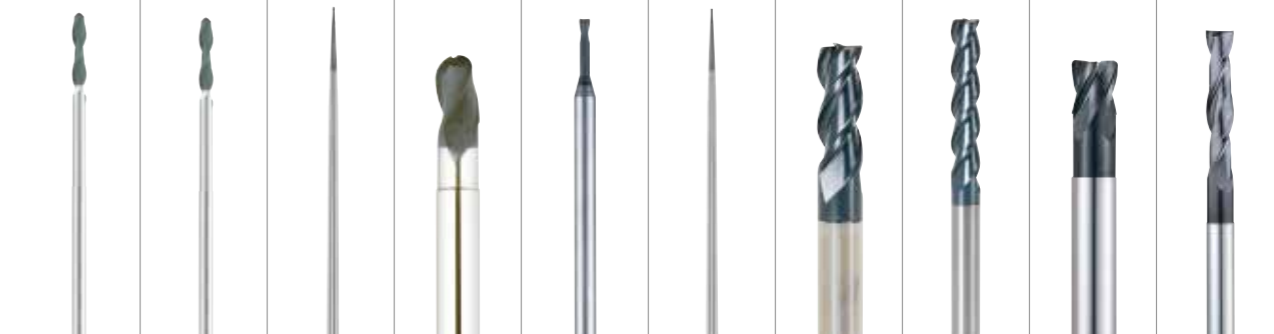

Large selection table with 10 columns corresponding to the series in the table above and 41 rows corresponding to the ISO/VDI codes in the table on the left. Contains selection marks (circles) for each tool series across various material groups.

CARBIDE, 2 FLUTE MINIATURE BALL NOSE with NECK

VOLLHARTMETALL, 2 SCHNEIDEN MINI STIRNRADIUS mit ABGESETZTEM SCHAFTTETL
Fraise carbure, 2 dents, hémisphérique, détalonnée, micro-fraise
2 TAGLIENTI, SEMISFERICA, SERIE MINI, SCARICATA

- Higher hardness of film and excellent wear-resistance increase the tool life surprisingly.
- Ultra fine film of YG-1's diamond coated carbide ball end mills ensure the smooth and excellent surface on work materials.
- High performance on graphite, wrought aluminum, bakelite, plastics, wood, brass etc. YG-1's diamond coated carbide ball end mills have good result for the machining of non-ferrous metals and non-metallic materials.

- Höhere Härte der Beschichtung und ausgezeichnete Verschleißfestigkeit verlängern die Standzeit beachtlich.
- Ultrafeiner Film auf YG-1 Diamant - beschichteten Hartmetall Schafffräser gewährleisten eine glatte und ausgezeichnete Oberflächengüte.
- Hohe Leistungsfähigkeit bei Graphit, Aluminium ohne Silicon, Bakelit, Plastik, Holz, Messing, etc. YG-1 Diamant - beschichtete Hartmetall Schafffräser zeigen gute Ergebnisse beim Bearbeiten von NE - Metallen und Nichtmetall - Werkstoffen.

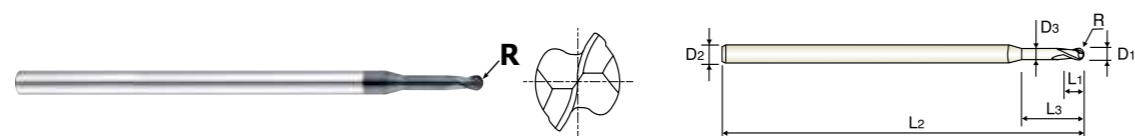

CARBIDE 2 30° ±0.01 PLAIN Diamond p.C493

Plain Shank	Page
HYDRAULIC CHUCK	D15-46
SHRINK FIT HOLDER	D47-72
POWER MILLING CHUCK	D161-176
ER COLLET CHUCK	D73-116
SK SLIM CHUCK	D183-201

Unit : mm

EDP No.	Radius of Ball Nose	Mill Diameter	Shank Diameter	Length of Cut	Length Below Shank	Overall Length	Neck Diameter
	R (±0.01)	D1	D2	L1	L3	L2	D3
EIB93004040	R0.2	0.4	4	0.6	4	45	0.36
EIB93004060	R0.2	0.4	4	0.6	6	45	0.36
EIB93006040	R0.3	0.6	4	1	4	45	0.56
EIB93006060	R0.3	0.6	4	1	6	45	0.56
EIB93006080	R0.3	0.6	4	1	8	45	0.56
EIB93010060	R0.5	1.0	4	1.5	6	45	0.95
EIB93010080	R0.5	1.0	4	1.5	8	45	0.95
EIB93010120	R0.5	1.0	4	1.5	12	45	0.95
EIB93015120	R0.75	1.5	4	1.75	12	45	1.45
EIB93020080	R1.0	2.0	4	3	8	60	1.95
EIB93020120	R1.0	2.0	4	3	12	60	1.95
EIB93020160	R1.0	2.0	4	3	16	60	1.95
EIB93040160	R2.0	4.0	4	6	16	60	3.9

Mill Dia. Tolerance (mm)	Shank Dia. Tolerance
0 ~ - 0.02	h5

◎ : Excellent ○ : Good

ISO Material Description	P									M						K				
	Non-alloy steel			Low alloy steel			High alloyed steel, and tool steel			Stainless steel			Grey cast iron	Nodular cast iron		Malleable cast iron				
VDI 3323	1	2	3	4	5	6	7	8	9	10	11	12	13	14	15	16	17	18	19	20
HRc	13	25	28	32	30	29	32	38	15	35	15	23	10	10	26	3	25	21		
HB	125	190	250	270	300	180	275	300	350	200	325	200	240	180	180	260	160	250	130	230
Recommend																				

ISO Material Description	N					S						H									
	Aluminum-wrought alloy		Aluminum-cast, alloyed		Copper and Copper Alloys (Bronze / Brass)	Heat Resistant Super Alloys			Titanium Alloys			Hardened steel	Chilled Cast Iron	Hardened Cast Iron							
VDI 3323	21	22	23	24	25	26	27	28	29	30	31	32	33	34	35	36	37	38	39	40	41
HRc											15	30	25	38	34			55	60	42	55
HB	60	100	75	90	130	110	90	100			200	280	250	350	320	400 Rm	1050 Rm	550	630	400	550
Recommend	○	○	○	○	○				◎												

CARBIDE, 2 FLUTE BALL NOSE SHORT LENGTH with NECK

VOLLHARTMETALL, 2 SCHNEIDEN STIRNRADIUS KURZ mit ABGESETZTEM SCHAFTTETL
Fraise carbure, 2 dents, hémisphérique, détalonnée, courte
2 TAGLIENTI, SEMISFERICA, SERIE CORTA, SCARICATA

- Higher hardness of film and excellent wear-resistance increase the tool life surprisingly.
- Ultra fine film of YG-1's diamond coated carbide ball end mills ensure the smooth and excellent surface on work materials.
- High performance on graphite, wrought aluminum, bakelite, plastics, wood, brass etc. YG-1's diamond coated carbide ball end mills have good result for the machining of non-ferrous metals and non-metallic materials.

- Höhere Härte der Beschichtung und ausgezeichnete Verschleißfestigkeit verlängern die Standzeit beachtlich.
- Ultrafeiner Film auf YG-1 Diamant - beschichteten Hartmetall Schafffräser gewährleisten eine glatte und ausgezeichnete Oberflächengüte.
- Hohe Leistungsfähigkeit bei Graphit, Aluminium ohne Silicon, Bakelit, Plastik, Holz, Messing, etc. YG-1 Diamant - beschichtete Hartmetall Schafffräser zeigen gute Ergebnisse beim Bearbeiten von NE - Metallen und Nichtmetall - Werkstoffen.

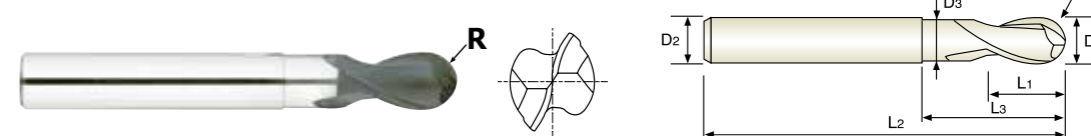

CARBIDE 2 30° ±0.01 PLAIN Diamond p.C493

Plain Shank	Page
HYDRAULIC CHUCK	D15-46
SHRINK FIT HOLDER	D47-72
POWER MILLING CHUCK	D161-176
ER COLLET CHUCK	D73-116
SK SLIM CHUCK	D183-201

Unit : mm

EDP No.	Radius of Ball Nose	Mill Diameter	Shank Diameter	Length of Cut	Length Below Shank	Overall Length	Neck Diameter
	R (±0.01)	D1	D2	L1	L3	L2	D3
EI880020	R1.0	2.0	6	3	5	60	1.9
EI880025	R1.25	2.5	6	4	6	60	2.4
EI880030	R1.5	3.0	6	4.5	6.5	60	2.8
EI880035	R1.75	3.5	6	5	7	65	3.2
EI880040	R2.0	4.0	6	6	8	65	3.7
EI880050	R2.5	5.0	6	7.5	10	65	4.6
EI880060	R3.0	6.0	6	9	12	75	5.6
EI880080	R4.0	8.0	8	12	25	75	7.4
EI880100	R5.0	10.0	10	15	30	80	9.4
EI880120	R6.0	12.0	12	18	36	90	11.4

Mill Dia. Tolerance (mm)	Shank Dia. Tolerance
0 ~ - 0.03	h5

◎ : Excellent ○ : Good

ISO Material Description	P									M						K				
	Non-alloy steel			Low alloy steel			High alloyed steel, and tool steel			Stainless steel			Grey cast iron	Nodular cast iron		Malleable cast iron				
VDI 3323	1	2	3	4	5	6	7	8	9	10	11	12	13	14	15	16	17	18	19	20
HRc	13	25	28	32	30	29	32	38	15	35	15	23	10	10	26	3	25	21		
HB	125	190	250	270	300	180	275	300	350	200	325	200	240	180	180	260	160	250	130	230
Recommend																				

ISO Material Description	N					S						H									
	Aluminum-wrought alloy		Aluminum-cast, alloyed		Copper and Copper Alloys (Bronze / Brass)	Heat Resistant Super Alloys			Titanium Alloys			Hardened steel	Chilled Cast Iron	Hardened Cast Iron							
VDI 3323	21	22	23	24	25	26	27	28	29	30	31	32	33	34	35	36	37	38	39	40	41
HRc											15	30	25	38	34			55	60	42	55
HB	60	100	75	90	130	110	90	100			200	280	250	350	320	400 Rm	1050 Rm	550	630	400	550
Recommend	○	○	○	○	○				◎												

CARBIDE, 2 FLUTE BALL NOSE LONG LENGTH with NECK

● **VOLLHARTMETALL, 2 SCHNEIDEN STIRNRADIUS LANG mit ABGESETZTEM SCHAFTTETEL**
 (●) **Fraise carbure, 2 dents, hémisphérique, détalonnée, longue**
 (●) **2 TAGLIENTI, SEMISFERICA, SERIE LUNGA**

- ▶ Higher hardness of film and excellent wear-resistance increase the tool life surprisingly.
- ▶ Ultra fine film of YG-1's diamond coated carbide ball end mills ensure the smooth and excellent surface on work materials.
- ▶ High performance on graphite, wrought aluminum, bakelite, plastics, wood, brass etc. YG-1's diamond coated carbide ball end mills have good result for the machining of non-ferrous metals and non-metallic materials.
- ▶ Höhere Härte der Beschichtung und ausgezeichnete Verschleißfestigkeit verlängern die Standzeit beachtlich.
- ▶ Ultrafeiner Film auf YG-1 Diamant - beschichteten Hartmetall Schafffräser gewährleisten eine glatte und ausgezeichnete Oberflächengüte.
- ▶ Hohe Leistungsfähigkeit bei Graphit, Aluminium ohne Silicon, Bakelit, Plastik, Holz, Messing, etc. YG-1 Diamant - beschichtete Hartmetall Schafffräser zeigen gute Ergebnisse beim Bearbeiten von NE - Metallen und Nichtmetall - Werkstoffen.

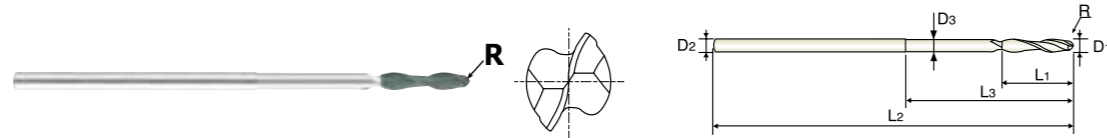

CARBIDE 2 30° ±0.01 PLAIN Diamond p.C493

Recommended ToolHolder:

- HYDRAULIC CHUCK SHRINK FIT HOLDER (D15-46, D47-72)
- POWER MILLING CHUCK (D161-176)
- ER COLLET CHUCK SK SLIM CHUCK (D73-116, D183-201)

Unit : mm

EDP No.	Radius of Ball Nose	Mill Diameter	Shank Diameter	Length of Cut	Length Below Shank	Overall Length	Neck Diameter
	R (±0.01)	D1	D2	L1	L3	L2	D3
EI451020	R1.0	2.0	4	10	20	80	1.95
EI451030	R1.5	3.0	4	15	25	80	2.9
EI451040	R2.0	4.0	4	20	30	80	3.9
EI451050	R2.5	5.0	6	30	50	100	4.9
EI451060	R3.0	6.0	6	30	50	100	5.5
EI451070	R3.5	7.0	6	30	-	100	-
EI451080	R4.0	8.0	8	40	60	110	7.5
EI451090	R4.5	9.0	8	40	-	110	-
EI451100	R5.0	10.0	10	50	70	120	9.5
EI451120	R6.0	12.0	12	55	75	130	11.5

Mill Dia. Tolerance (mm)	Shank Dia. Tolerance
0 ~ - 0.03	h5

◎ : Excellent ○ : Good

ISO Material Description	P									M				K						
	Non-alloy steel			Low alloy steel			High alloyed steel, and tool steel			Stainless steel		Grey cast iron		Nodular cast iron		Malleable cast iron				
VDI 3323	1	2	3	4	5	6	7	8	9	10	11	12	13	14	15	16	17	18	19	20
HRc	13	25	28	32	30	10	29	32	38	15	35	15	23	10	10	26	3	25	21	21
HB	125	190	250	270	300	180	275	300	350	200	325	200	240	180	180	260	160	250	130	230
Recommend																				

ISO Material Description	N					S					H										
	Aluminum-wrought alloy		Aluminum-cast, alloyed		Copper and Copper Alloys (Bronze / Brass)	Heat Resistant Super Alloys			Titanium Alloys		Hardened steel	Chilled Cast Iron		Hardened Cast Iron							
VDI 3323	21	22	23	24	25	26	27	28	29	30	31	32	33	34	35	36	37	38	39	40	41
HRc	21	22	23	24	25	26	27	28	29	30	31	32	33	34	35	36	37	38	39	40	41
HB	60	100	75	90	130	110	90	100			200	280	250	350	320	400 Rm	1050 Rm	550	630	400	550
Recommend	○	○	○	○	○				◎												

CARBIDE, 2 FLUTE BALL NOSE LONG REACH with NECK

● **VOLLHARTMETALL, 2 SCHNEIDEN STIRNRADIUS GROÙE REICHWEITE mit ABGESETZTEM SCHAFTTETEL**
 (●) **Fraise carbure, 2 dents, hémisphérique longue portée, détalonnée**
 (●) **2 TAGLIENTI, SEMISFERICA PER CAVITA' PROFONDE**

- ▶ Higher hardness of film and excellent wear-resistance increase the tool life surprisingly.
- ▶ Ultra fine film of YG-1's diamond coated carbide ball end mills ensure the smooth and excellent surface on work materials.
- ▶ High performance on graphite, wrought aluminum, bakelite, plastics, wood, brass etc. YG-1's diamond coated carbide ball end mills have good result for the machining of non-ferrous metals and non-metallic materials.
- ▶ Höhere Härte der Beschichtung und ausgezeichnete Verschleißfestigkeit verlängern die Standzeit beachtlich.
- ▶ Ultrafeiner Film auf YG-1 Diamant - beschichteten Hartmetall Schafffräser gewährleisten eine glatte und ausgezeichnete Oberflächengüte.
- ▶ Hohe Leistungsfähigkeit bei Graphit, Aluminium ohne Silicon, Bakelit, Plastik, Holz, Messing, etc. YG-1 Diamant - beschichtete Hartmetall Schafffräser zeigen gute Ergebnisse beim Bearbeiten von NE - Metallen und Nichtmetall - Werkstoffen.

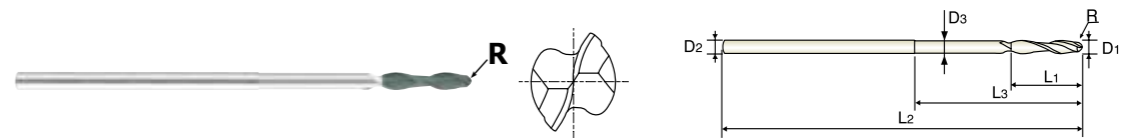

CARBIDE 2 30° ±0.01 PLAIN Diamond p.C493

Recommended ToolHolder:

- HYDRAULIC CHUCK SHRINK FIT HOLDER (D15-46, D47-72)
- POWER MILLING CHUCK (D161-176)
- ER COLLET CHUCK SK SLIM CHUCK (D73-116, D183-201)

Unit : mm

EDP No.	Radius of Ball Nose	Mill Diameter	Shank Diameter	Length of Cut	Length Below Shank	Overall Length	Neck Diameter
	R (±0.01)	D1	D2	L1	L3	L2	D3
EI450020	R1.0	2.0	4	10	20	100	1.95
EI450030	R1.5	3.0	4	15	25	100	2.9
EI450040	R2.0	4.0	4	20	30	100	3.9
EI450050	R2.5	5.0	6	30	50	120	4.9
EI450060	R3.0	6.0	6	30	50	150	5.5
EI450070	R3.5	7.0	6	30	-	150	-
EI450080	R4.0	8.0	8	40	60	150	7.5
EI450090	R4.5	9.0	8	40	-	150	-
EI450100	R5.0	10.0	10	50	70	180	9.5
EI450120	R6.0	12.0	12	55	75	200	11.5

Mill Dia. Tolerance (mm)	Shank Dia. Tolerance
0 ~ - 0.03	h5

◎ : Excellent ○ : Good

ISO Material Description	P									M				K						
	Non-alloy steel			Low alloy steel			High alloyed steel, and tool steel			Stainless steel		Grey cast iron		Nodular cast iron		Malleable cast iron				
VDI 3323	1	2	3	4	5	6	7	8	9	10	11	12	13	14	15	16	17	18	19	20
HRc	13	25	28	32	30	10	29	32	38	15	35	15	23	10	10	26	3	25	21	21
HB	125	190	250	270	300	180	275	300	350	200	325	200	240	180	180	260	160	250	130	230
Recommend																				

ISO Material Description	N					S					H										
	Aluminum-wrought alloy		Aluminum-cast, alloyed		Copper and Copper Alloys (Bronze / Brass)	Heat Resistant Super Alloys			Titanium Alloys		Hardened steel	Chilled Cast Iron		Hardened Cast Iron							
VDI 3323	21	22	23	24	25	26	27	28	29	30	31	32	33	34	35	36	37	38	39	40	41
HRc	21	22	23	24	25	26	27	28	29	30	31	32	33	34	35	36	37	38	39	40	41
HB	60	100	75	90	130	110	90	100			200	280	250	350	320	400 Rm	1050 Rm	550	630	400	550
Recommend	○	○	○	○	○				◎												

CARBIDE, 2 FLUTE BALL NOSE with TAPER NECK

VOLLHARTMETALL, 2 SCHNEIDEN STIRNRADIUS mit KONISCH ABGESETZTEM SCHAFTTEIL
Fraise carbure, 2 dents, hémisphérique avec entrée conique
2 TAGLIENTI, SEMISFERICA CON SCARICO CONICO

- Higher hardness of film and excellent wear-resistance increase the tool life surprisingly.
Ultra fine film of YG-1's diamond coated carbide ball end mills ensure the smooth and excellent surface on work materials.
High performance on graphite, wrought aluminum, bakelite, plastics, wood, brass etc. YG-1's diamond coated carbide ball end mills have good result for the machining of non-ferrous metals and non-metallic materials.

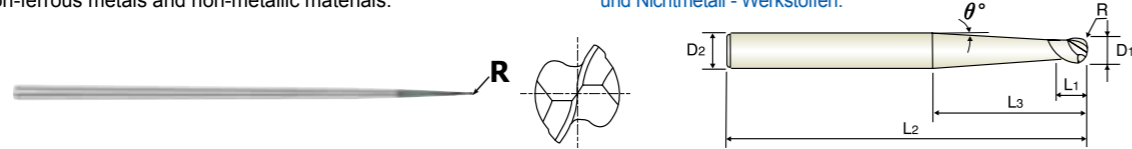

Icons for Carbide, 2 flutes, 30 degree angle, R radius, Plain shank, Diamond coating, and Recommended Tool Holder. Includes a table of recommended tool holders and their page numbers.

Unit : mm

Table with 8 columns: EDP No., Radius of Ball Nose, Mill Diameter, Shank Diameter, Length of Cut, Length Below Shank, Overall Length, Neck Taper Angle. Lists various end mill models and their specifications.

Table with 2 columns: Mill Dia. Tolerance (mm) and Shank Dia. Tolerance. Values: 0 ~ - 0.02, h5.

ISO material compatibility chart for EIB87 series. Columns include Non-alloy steel, Low alloy steel, High alloyed steel, Stainless steel, Grey cast iron, Nodular cast iron, Malleable cast iron, Aluminum-wrought alloy, Aluminum-cast, alloyed, Copper and Copper Alloys, Non Metallic Materials, Heat Resistant Super Alloys, Titanium Alloys, Hardened steel, Chilled Cast Iron, Hardened Cast Iron.

CARBIDE, 3 FLUTE BALL NOSE SHORT LENGTH with NECK

VOLLHARTMETALL, 3 SCHNEIDEN STIRNRADIUS KURZ mit ABGESETZTEM SCHAFTTETEL
Fraise carbure, 3 dents, hémisphérique, détalonnée, courte
3 TAGLIENTI, SEMISFERICA, SERIE CORTA

- Higher hardness of film and excellent wear-resistance increase the tool life surprisingly.
Ultra fine film of YG-1's diamond coated carbide ball end mills ensure the smooth and excellent surface on work materials.
High performance on graphite, wrought aluminum, bakelite, plastics, wood, brass etc. YG-1's diamond coated carbide ball end mills have good result for the machining of non-ferrous metals and non-metallic materials.

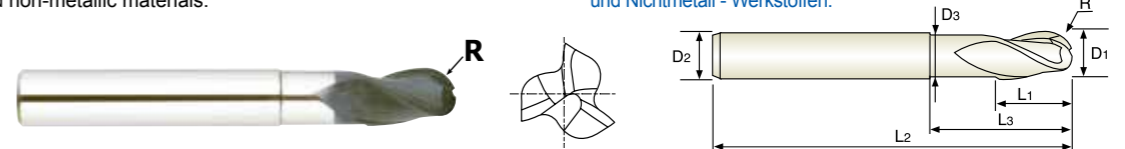

Icons for Carbide, 3 flutes, 30 degree angle, R radius, Plain shank, Diamond coating, and Recommended Tool Holder. Includes a table of recommended tool holders and their page numbers.

Unit : mm

Table with 8 columns: EDP No., Radius of Ball Nose, Mill Diameter, Shank Diameter, Length of Cut, Length Below Shank, Overall Length, Neck Diameter. Lists various end mill models and their specifications.

Table with 2 columns: Mill Dia. Tolerance (mm) and Shank Dia. Tolerance. Values: 0 ~ - 0.03, h5.

ISO material compatibility chart for EI881 series. Columns include Non-alloy steel, Low alloy steel, High alloyed steel, Stainless steel, Grey cast iron, Nodular cast iron, Malleable cast iron, Aluminum-wrought alloy, Aluminum-cast, alloyed, Copper and Copper Alloys, Non Metallic Materials, Heat Resistant Super Alloys, Titanium Alloys, Hardened steel, Chilled Cast Iron, Hardened Cast Iron.

CARBIDE, 2 FLUTE CORNER RADIUS with TAPER NECK

- VOLLHARTMETALL, 2 SCHEIDEN ECKENRADIUS mit KONISCH ABGESETZTEM SCHAFTTEIL
- Fraise carbure, 2 dents, torique avec entrée conique
- 2 TAGLIENTI, TORICA CON SCARICO CONICO

- ▶ Higher hardness of film and excellent wear-resistance increase the tool life surprisingly.
 - ▶ Ultra fine film of YG-1's diamond coated carbide end mills ensure the smooth and excellent surface on work materials.
 - ▶ High performance on graphite, wrought aluminum, bakelite, plastics, wood, brass etc. YG-1's diamond coated carbide end mills have good result for the machining of non-ferrous metals and non-metallic materials.
- ▶ Höhere Härte der Beschichtung und ausgezeichnete Verschleißfestigkeit verlängern die Standzeit beachtlich.
 - ▶ Ultrafeiner Film auf YG-1 Diamant - beschichteten Hartmetall Schafffräser gewährleisten eine glatte und ausgezeichnete Oberflächengüte.
 - ▶ Hohe Leistungsfähigkeit bei Graphit, Aluminium ohne Silicon, Bakelit, Plastik, Holz, Messing, etc. YG-1 Diamant - beschichtete Hartmetall Schafffräser zeigen gute Ergebnisse beim Bearbeiten von NE - Metallen und Nichtmetall - Werkstoffen.



CARBIDE 2 30° PLAIN Diamond p.C493

Plain Shank	Page
HYDRAULIC CHUCK SHRINK FIT HOLDER	D15 - 46 D47 - 72
POWER MILLING CHUCK	D161 - 176
ER COLLET CHUCK SK SLIM CHUCK	D73 - 116 D183 - 201

Unit : mm

EDP No.	Corner Radius	Mill Diameter	Shank Diameter	Length of Cut	Length Below Shank	Overall Length	Neck Taper Angle
	R	D1	D2	L1	L3	L2	θ°
EIB86010	R0.1	1.0	3	2	30	60	2°
EIB86901	R0.1	1.0	3	2	70	100	1°
EIB86015	R0.15	1.5	3	3	30	60	1° 30'
EIB86902	R0.15	1.5	3	3	50	100	1°
EIB86020	R0.15	2.0	3	4	30	60	1°
EIB86903	R0.15	2.0	4	4	70	100	1°

Mill Dia. Tolerance (mm)	Shank Dia. Tolerance
0 ~ - 0.02	h5

◎ : Excellent ○ : Good

ISO Material Description	P									M				K							
	Non-alloy steel			Low alloy steel			High alloyed steel, and tool steel			Stainless steel		Grey cast iron	Nodular cast iron		Malleable cast iron						
VDI 3323	1	2	3	4	5	6	7	8	9	10	11	12	13	14	15	16	17	18	19	20	
HRc	13	25	28	32	10	29	32	38	15	35	15	23	10	10	26	3	25	21	21		
HB	125	190	250	270	300	180	275	300	350	200	325	200	240	180	180	260	160	250	130	230	
Recommend																					

ISO Material Description	N				S						H											
	Aluminum-wrought alloy		Aluminum-cast, alloyed		Copper and Copper Alloys (Bronze / Brass)			Non Metallic Materials			Heat Resistant Super Alloys			Hardened steel	Chilled Cast Iron	Hardened Cast Iron						
VDI 3323	21	22	23	24	25	26	27	28	29	30	31	32	33	34	35	36	37	38	39	40	41	
HRc	21	22	23	24	25	26	27	28	29	30	31	32	33	34	35	36	37	38	39	40	41	
HB	60	100	75	90	130	110	90	100			200	280	250	350	320	400 Rm	1050 Rm	550	630	400	550	
Recommend	○	○	○	○	○				◎													

CARBIDE, 3 FLUTE 40° HELIX CORNER RADIUS SHORT LENGTH

- VOLLHARTMETALL, 3 SCHNEIDEN 40° RECHTSSPIRALE ECKENRADIUS KURZ
- Fraise carbure, 3 dents, torique, hélice 40°, courte
- 3 TAGLIENTI, ELICA 40°, TORICA, SERIE CORTA

- ▶ Higher hardness of film and excellent wear-resistance increase the tool life surprisingly.
 - ▶ Ultra fine film of YG-1's diamond coated carbide end mills ensure the smooth and excellent surface on work materials.
 - ▶ High performance on graphite, wrought aluminum, bakelite, plastics, wood, brass etc. YG-1's diamond coated carbide end mills have good result for the machining of non-ferrous metals and non-metallic materials.
- ▶ Höhere Härte der Beschichtung und ausgezeichnete Verschleißfestigkeit verlängern die Standzeit beachtlich.
 - ▶ Ultrafeiner Film auf YG-1 Diamant - beschichteten Hartmetall Schafffräser gewährleisten eine glatte und ausgezeichnete Oberflächengüte.
 - ▶ Hohe Leistungsfähigkeit bei Graphit, Aluminium ohne Silicon, Bakelit, Plastik, Holz, Messing, etc. YG-1 Diamant - beschichtete Hartmetall Schafffräser zeigen gute Ergebnisse beim Bearbeiten von NE - Metallen und Nichtmetall - Werkstoffen.

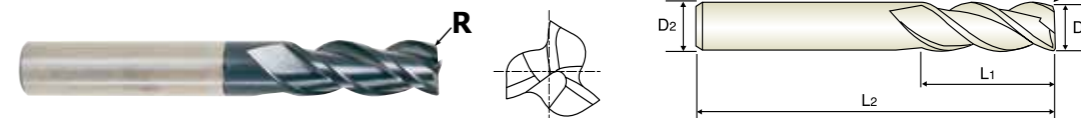

CARBIDE 3 40° PLAIN Diamond p.C494

Plain Shank	Page
HYDRAULIC CHUCK SHRINK FIT HOLDER	D15 - 46 D47 - 72
POWER MILLING CHUCK	D161 - 176
ER COLLET CHUCK SK SLIM CHUCK	D73 - 116 D183 - 201

Unit : mm

EDP No.	Corner Radius	Mill Diameter	Shank Diameter	Length of Cut	Overall Length
	R	D1	D2	L1	L2
EIA13020	R0.15	2.0	3	6	40
EIA13030	R0.15	3.0	3	12	40
EIA13040	R0.2	4.0	4	14	50
EIA13050	R0.3	5.0	5	16	50
EIA13060	R0.3	6.0	6	20	65
EIA13080	R0.5	8.0	8	20	65
EIA13100	R0.5	10.0	10	25	75
EIA13120	R0.5	12.0	12	25	75

Mill Dia. Tolerance (mm)	Shank Dia. Tolerance
0 ~ - 0.03	h5

◎ : Excellent ○ : Good

ISO Material Description	P									M				K							
	Non-alloy steel			Low alloy steel			High alloyed steel, and tool steel			Stainless steel		Grey cast iron	Nodular cast iron		Malleable cast iron						
VDI 3323	1	2	3	4	5	6	7	8	9	10	11	12	13	14	15	16	17	18	19	20	
HRc	13	25	28	32	10	29	32	38	15	35	15	23	10	10	26	3	25	21	21		
HB	125	190	250	270	300	180	275	300	350	200	325	200	240	180	180	260	160	250	130	230	
Recommend																					

ISO Material Description	N				S						H											
	Aluminum-wrought alloy		Aluminum-cast, alloyed		Copper and Copper Alloys (Bronze / Brass)			Non Metallic Materials			Heat Resistant Super Alloys			Hardened steel	Chilled Cast Iron	Hardened Cast Iron						
VDI 3323	21	22	23	24	25	26	27	28	29	30	31	32	33	34	35	36	37	38	39	40	41	
HRc	21	22	23	24	25	26	27	28	29	30	31	32	33	34	35	36	37	38	39	40	41	
HB	60	100	75	90	130	110	90	100			200	280	250	350	320	400 Rm	1050 Rm	550	630	400	550	
Recommend	○	○	○	○	○				◎													

CARBIDE, 3 FLUTE 40° HELIX CORNER RADIUS LONG LENGTH

● **VOLLHARTMETALL, 3 SCHNEIDN 40° RECHTSSPIRALE ECKENRADIUS LANG**
 (●) **Fraise carbure, 3 dents, torique, hélice 40°, longue**
 (●) **3 TAGLIENTI, ELICA 40°, TORICA, SERIE LUNGA**

- ▶ Higher hardness of film and excellent wear-resistance increase the tool life surprisingly.
 - ▶ Ultra fine film of YG-1's diamond coated carbide end mills ensure the smooth and excellent surface on work materials.
 - ▶ High performance on graphite, wrought aluminum, bakelite, plastics, wood, brass etc. YG-1's diamond coated carbide end mills have good result for the machining of non-ferrous metals and non-metallic materials.
- ▶ Höhere Härte der Beschichtung und ausgezeichnete Verschleißfestigkeit verlängern die Standzeit beachtlich.
 - ▶ Ultrafeiner Film auf YG-1 Diamant - beschichteten Hartmetall Schafffräser gewährleisten eine glatte und ausgezeichnete Oberflächengüte.
 - ▶ Hohe Leistungsfähigkeit bei Graphit, Aluminium ohne Silicon, Bakelit, Plastik, Holz, Messing, etc. YG-1 Diamant - beschichtete Hartmetall Schafffräser zeigen gute Ergebnisse beim Bearbeiten von NE - Metallen und Nichtmetall - Werkstoffen.

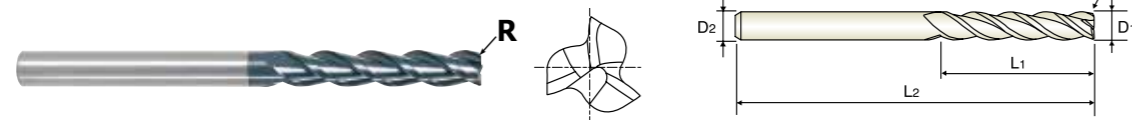

Plain Shank	Page
HYDRAULIC CHUCK SHRINK FIT HOLDER	D15 - 46 D47 - 72
POWER MILLING CHUCK	D161 - 176
ER COLLET CHUCK SK SLIM CHUCK	D73 - 116 D183 - 201

Unit : mm

EDP No.	Corner Radius	Mill Diameter	Shank Diameter	Length of Cut		Overall Length
	R	D1	D2	L1	L2	L2
EIA14020	R0.15	2.0	3	9	60	60
EIA14030	R0.15	3.0	3	30	60	60
EIA14040	R0.2	4.0	4	30	60	60
EIA14050	R0.3	5.0	5	35	70	70
EIA14060	R0.3	6.0	6	40	100	100
EIA14080	R0.5	8.0	8	40	100	100
EIA14100	R0.5	10.0	10	40	100	100
EIA14120	R0.5	12.0	12	45	100	100

Mill Dia. Tolerance (mm)	Shank Dia. Tolerance
0 ~ - 0.03	h5

◎ : Excellent ○ : Good

ISO Material Description	P									M				K						
	Non-alloy steel			Low alloy steel			High alloyed steel, and tool steel			Stainless steel		Grey cast iron	Nodular cast iron		Malleable cast iron					
VDI 3323	1	2	3	4	5	6	7	8	9	10	11	12	13	14	15	16	17	18	19	20
HRc	13	25	28	32	30	10	29	32	38	15	35	15	23	10	10	26	3	25	21	21
HB	125	190	250	270	300	180	275	300	350	200	325	200	240	180	180	260	160	250	130	230
Recommend																				

ISO Material Description	N					S					H										
	Aluminum-wrought alloy		Aluminum-cast, alloyed		Copper and Copper Alloys (Bronze / Brass)	Heat Resistant Super Alloys		Titanium Alloys		Hardened steel	Chilled Cast Iron	Hardened Cast Iron									
VDI 3323	21	22	23	24	25	26	27	28	29	30	31	32	33	34	35	36	37	38	39	40	41
HRc	21	22	23	24	25	26	27	28	29	30	31	32	33	34	35	36	37	38	39	40	41
HB	60	100	75	90	130	110	90	100			200	280	250	350	320	400 Rm	1050 Rm	550	630	400	550
Recommend	○	○	○	○	○				◎												

CARBIDE, 4 FLUTE CORNER RADIUS with NECK

● **VOLLHARTMETALL, 4 SCHNEIDEN ECKENRADIUS mit ABGESETZTEM SCHAFTTETL**
 (●) **Fraise carbure, 4 dents, torique, détalonnée**
 (●) **4 TAGLIENTI, TORICA, SCARICATA**

- ▶ Higher hardness of film and excellent wear-resistance increase the tool life surprisingly.
 - ▶ Ultra fine film of YG-1's diamond coated carbide end mills ensure the smooth and excellent surface on work materials.
 - ▶ High performance on graphite, wrought aluminum, bakelite, plastics, wood, brass etc. YG-1's diamond coated carbide end mills have good result for the machining of non-ferrous metals and non-metallic materials.
- ▶ Höhere Härte der Beschichtung und ausgezeichnete Verschleißfestigkeit verlängern die Standzeit beachtlich.
 - ▶ Ultrafeiner Film auf YG-1 Diamant - beschichteten Hartmetall Schafffräser gewährleisten eine glatte und ausgezeichnete Oberflächengüte.
 - ▶ Hohe Leistungsfähigkeit bei Graphit, Aluminium ohne Silicon, Bakelit, Plastik, Holz, Messing, etc. YG-1 Diamant - beschichtete Hartmetall Schafffräser zeigen gute Ergebnisse beim Bearbeiten von NE - Metallen und Nichtmetall - Werkstoffen.

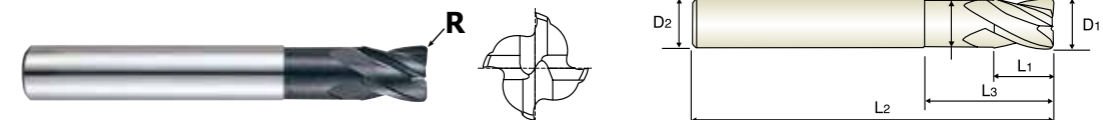

Plain Shank	Page
HYDRAULIC CHUCK SHRINK FIT HOLDER	D15 - 46 D47 - 72
POWER MILLING CHUCK	D161 - 176
ER COLLET CHUCK SK SLIM CHUCK	D73 - 116 D183 - 201

Unit : mm

EDP No.	Corner Radius	Mill Diameter	Shank Diameter	Length of Cut	Length Below Shank	Overall Length	Neck Diameter
	R	D1	D2	L1	L3	L2	D3
EIB88060	R0.5	6.0	6	10	40	80	5.9
EIB88080	R0.5	8.0	8	10	40	80	7.8
EIB88901	R1.0	8.0	8	10	60	100	7.8
EIB88100	R0.5	10.0	10	25	-	75	-
EIB88902	R0.5	10.0	10	12	40	80	9.8
EIB88903	R1.0	10.0	10	12	40	80	9.8
EIB88904	R0.5	10.0	10	12	80	125	9.8
EIB88120	R0.5	12.0	12	25	-	80	-
EIB88905	R0.5	12.0	12	15	40	80	11.8
EIB88906	R1.0	12.0	12	15	40	80	11.8
EIB88907	R1.0	12.0	12	15	80	125	11.8

Mill Dia. Tolerance (mm)	Shank Dia. Tolerance
0 ~ - 0.03	h5

◎ : Excellent ○ : Good

ISO Material Description	P									M				K						
	Non-alloy steel			Low alloy steel			High alloyed steel, and tool steel			Stainless steel		Grey cast iron	Nodular cast iron		Malleable cast iron					
VDI 3323	1	2	3	4	5	6	7	8	9	10	11	12	13	14	15	16	17	18	19	20
HRc	13	25	28	32	30	10	29	32	38	15	35	15	23	10	10	26	3	25	21	21
HB	125	190	250	270	300	180	275	300	350	200	325	200	240	180	180	260	160	250	130	230
Recommend																				

ISO Material Description	N					S					H										
	Aluminum-wrought alloy		Aluminum-cast, alloyed		Copper and Copper Alloys (Bronze / Brass)	Heat Resistant Super Alloys		Titanium Alloys		Hardened steel	Chilled Cast Iron	Hardened Cast Iron									
VDI 3323	21	22	23	24	25	26	27	28	29	30	31	32	33	34	35	36	37	38	39	40	41
HRc	21	22	23	24	25	26	27	28	29	30	31	32	33	34	35	36	37	38	39	40	41
HB	60	100	75	90	130	110	90	100			200	280	250	350	320	400 Rm	1050 Rm	550	630	400	550
Recommend	○	○	○	○	○				◎												



EIA13, EIA14 SERIES

3 FLUTE CORNER RADIUS - SIDE CUTTING

Vc = m/min.
fz = mm/tooth
RPM = rev./min.
FEED = mm/min.

ISO	VDI 3323	Material Description	Ae	Ap	Parameter	Diameter (Ø)							
						2.0	3.0	4.0	5.0	6.0	8.0	10.0	12.0
N	29.2	Graphite	0.3D	0.3D	Vc	250	375	505	630	755	805	815	790
					fz	0.025	0.035	0.05	0.06	0.07	0.088	0.11	0.13
					RPM	39789	39789	40187	40107	40054	32030	25942	20955
					FEED	2984	4178	6028	7219	8411	8456	8561	8173

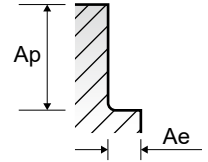

EIB88 SERIES

4 FLUTE CORNER RADIUS - SIDE CUTTING

ISO	VDI 3323	Material Description	Ae	Ap	Parameter	Diameter (Ø)			
						6.0	8.0	10.0	12.0
N	29.2	Graphite	0.3D	0.3D	Vc	755	805	815	790
					fz	0.035	0.044	0.055	0.065
					RPM	40054	32030	25942	20955
					FEED	5608	5637	5707	5448

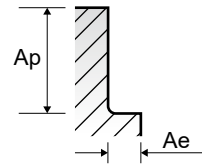

EIB04 SERIES

2 FLUTE - SIDE CUTTING

ISO	VDI 3323	Material Description	Ae	Ap	Parameter	Diameter (Ø)												
						0.4	0.6	0.8	1.0	1.5	2.0	3.0	4.0	5.0	6.0	8.0	10.0	12.0
N	29.2	Graphite	0.1D	1.5D	Vc	50	75	100	125	190	155	190	225	220	205	200	205	205
					fz	0.003	0.004	0.007	0.009	0.010	0.016	0.020	0.026	0.043	0.064	0.081	0.092	0.109
					RPM	39789	39789	39789	39789	40319	24669	20160	17905	14006	10876	7958	6525	5438
					FEED	239	318	557	716	806	789	806	931	1204	1392	1289	1201	1185

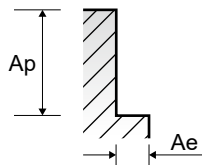



Leading Through Innovation



SOLID CARBIDE

CRX S END MILLS

CRX S FRÄSER

- DLC Coated Carbide End Mills for Copper
- DLC beschichtete VHM Fräser für die Kuper

SGED27 SERIES 2 FLUTE BALL

Vc = m/min.
fz = mm/tooth
RPM = rev./min.
FEED = mm/min.

ISO	VDI 3323	Material Description	Ae	Ap	Parameter	Diameter (Ø)											
						0.5	0.6	0.8	1.0	2.0	3.0	4.0	5.0	6.0	8.0	10.0	12.0
N	21	Aluminum-wrought alloy	0.05D	0.02D	Vc	80	95	125	155	250	245	240	240	245	250	250	250
					fz	0.005	0.007	0.009	0.01	0.022	0.03	0.042	0.052	0.061	0.079	0.1	0.122
					RPM	50930	50399	49736	49338	39789	25995	19099	15279	12998	9947	7958	6631
	FEED	509	706	895	987	1751	1560	1604	1589	1586	1572	1592	1618				
	26-28	Copper and Copper Alloys (Bronze / Brass)	0.05D	0.02D	Vc	80	95	110	110	125	125	120	120	125	125	125	125
					fz	0.005	0.007	0.009	0.011	0.02	0.028	0.038	0.047	0.055	0.072	0.091	0.111
					RPM	50930	50399	43768	35014	19894	13263	9549	7639	6631	4974	3979	3316
	FEED	509	706	788	770	796	743	726	718	729	716	724	736				
	29.1	Duroplastic	0.05D	0.02D	Vc	80	95	125	155	315	370	360	365	370	375	375	375
fz					0.004	0.005	0.006	0.006	0.013	0.019	0.027	0.033	0.039	0.05	0.064	0.077	
RPM					50930	50399	49736	49338	50134	39258	28648	23237	19629	14921	11937	9947	
FEED	407	504	597	592	1303	1492	1547	1534	1531	1492	1528	1532					

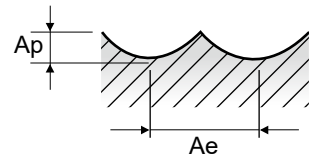

SGED30, SGED31 SERIES

2 FLUTE - SLOTTING

ISO	VDI 3323	Material Description	Ae	Ap	Parameter	Diameter (Ø)										
						0.5	0.6	0.8	1.0	2.0	3.0	4.0	6.0	8.0	10.0	12.0
N	21-22	Aluminum-wrought alloy	1.0D	0.5D	Vc	80	95	125	155	315	330	325	325	330	325	330
					fz	0.005	0.006	0.008	0.01	0.01	0.023	0.032	0.048	0.064	0.081	0.097
					RPM	50930	50399	49736	49338	50134	35014	25863	17242	13130	10345	8754
	FEED	509	605	796	987	1003	1611	1655	1655	1681	1676	1698				
	26-28	Copper and Copper Alloys (Bronze / Brass)	1.0D	0.5D	Vc	80	95	105	110	160	165	160	165	165	160	165
					fz	0.005	0.006	0.008	0.01	0.01	0.023	0.032	0.048	0.064	0.081	0.097
					RPM	50930	50399	41778	35014	25465	17507	12732	8754	6565	5093	4377
	FEED	509	605	668	700	509	805	815	840	840	825	849				
	29.1	Duroplastic	1.0D	0.5D	Vc	80	95	125	155	315	470	490	490	500	490	495
fz					0.001	0.002	0.002	0.003	0.004	0.007	0.009	0.014	0.018	0.023	0.028	
RPM					50930	50399	49736	49338	50134	49869	38993	25995	19894	15597	13130	
FEED	102	202	199	296	401	698	702	728	716	717	735					

2 FLUTE - SIDE CUTTING

ISO	VDI 3323	Material Description	Ae	Ap	Parameter	Diameter (Ø)										
						0.5	0.6	0.8	1.0	2.0	3.0	4.0	6.0	8.0	10.0	12.0
N	21-22	Aluminum-wrought alloy	0.5D	1.0D	Vc	80	95	125	130	260	260	265	270	265	265	270
					fz	0.005	0.006	0.008	0.01	0.011	0.025	0.034	0.053	0.069	0.086	0.107
					RPM	50930	50399	49736	41380	41380	27587	21088	14324	10544	8435	7162
	FEED	509	605	796	828	910	1379	1434	1518	1455	1451	1533				
	26-28	Copper and Copper Alloys (Bronze / Brass)	0.5D	1.0D	Vc	80	85	85	85	170	175	175	180	175	175	180
					fz	0.005	0.006	0.008	0.01	0.01	0.023	0.032	0.05	0.064	0.08	0.1
					RPM	50930	45094	33820	27056	27056	18568	13926	9549	6963	5570	4775
	FEED	509	541	541	541	541	854	891	955	891	891	955				
	29.1	Duroplastic	0.5D	1.0D	Vc	80	95	125	155	315	350	350	360	350	350	360
fz					0.004	0.005	0.006	0.008	0.009	0.018	0.026	0.04	0.051	0.064	0.08	
RPM					50930	50399	49736	49338	50134	37136	27852	19099	13926	11141	9549	
FEED	407	504	597	789	902	1337	1448	1528	1420	1426	1528					

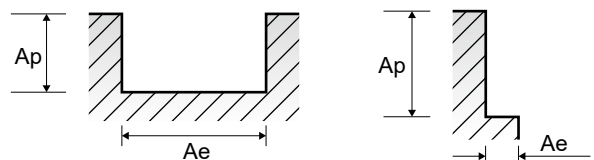



Leading Through Innovation



SOLID CARBIDE

K-2 END MILLS

K-2 VHM - Fräser

- General Purpose / Conventional or High Speed Milling / Wet & Dry Cutting
- Für allgemeinen Einsatz / Konventionelles oder Hochgeschwindigkeitsfräsen

SELECTION GUIDE



SOLID CARBIDE K-2 END MILLS

General Purpose Conventional or High Speed Milling Wet & Dry Cutting

Please visit globalyg1.com/mat for material search

◎ : Excellent ○ : Good

Recommended cutting conditions : P 597

Table with columns: ISO, VDI 3323, Material Description, Composition / Structure / Heat Treatment, HB, HRc, and 4 series of end mill types (G9624, G9A70, G9437, G9438). Rows include materials like Non-alloy steel, Low alloy steel, Stainless steel, Grey cast iron, etc.

Series specification table with columns: SERIES, FLUTE, HELIX ANGLE, CUTTING EDGE SHAPE, SIZE MIN, SIZE MAX, PAGE. Values include 2, 30°, BALL NOSE, R1.0, R10.0, C514-C517.



Series specification table with columns: G9454, G9455, G9B81, G9634, G9B82, G9B83, G9B84, G9B85, G9424, G9G44, G9A68. Values include 2, 30°, BALL NOSE, CORNER RADIUS, D1.0-D20.0, C518-C531.



Large compatibility table with 11 columns (series G9454-G9A68) and 41 rows (ISO 1-41). Contains circles (◎) and squares (◻) indicating compatibility.

SELECTION GUIDE



SOLID CARBIDE K-2 END MILLS

General Purpose with Coating Conventional or High Speed Milling, Wet or Dry Cutting

Please visit globalyg1.com/mat for material search

◎ : Excellent ○ : Good

Recommended cutting conditions : p. C565

Table with columns: ISO, VDI 3323, Material Description, Composition / Structure / Heat Treatment, HB, HRc, and performance indicators for series G9444, G9527, G9445, G9G45.

Table with columns: G9452, G9B80, G9410 G9553, G9G46, G9425, G9G47, G9439, G9528, G9433, G9G48, G9447 and performance indicators for various series.

SELECTION GUIDE

HSS



SOLID CARBIDE K-2 END MILLS

General Purpose with Coating Conventional or High Speed Milling, Wet or Dry Cutting



Please visit globalyg1.com/mat for material search

⊙ : Excellent ○ : Good

Recommended cutting conditions : p. C565

Table with 3 columns: SERIES (G9G49, G9432, G9G50), FLUTE (3, 4, 4), HELIX ANGLE (45°, 30°, 30°), CUTTING EDGE SHAPE (SQUARE, SQUARE, SQUARE), SIZE MIN (D3.0, D1.0, D3.0), SIZE MAX (D20.0, D20.0, D20.0), PAGE (C551, C552, C553), LONG LENGTH with CHAMFER, SHORT LENGTH, SHORT LENGTH with CHAMFER, TiAIN, TiAIN, TiAIN

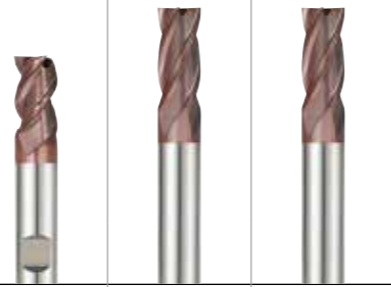

Main selection table with columns: ISO, VDI 3323, Material Description, Composition / Structure / Heat Treatment, HB, HRc, and performance indicators (⊙/○) for series G9G49, G9432, G9G50 across 41 rows.

HSS

Table with 11 columns: G9A69, G9448, G9540, G9449, G9G51, G9H73 G9H74, G9H75 G9H76, G9453, G9F45 G9F46, G9A42, G9400. Rows include flute counts, helix angles, cutting edge shapes, sizes, and coatings like TiAIN, X-Coating, Multi Flute.



Performance matrix table with 11 columns corresponding to tool types and 41 rows corresponding to ISO standards. Contains circles (⊙/○) indicating suitability.



PLAIN SHANK **G9624** SERIES

CARBIDE, 2 FLUTE SHORT LENGTH BALL NOSE

- VOLLHARTMETALL, 2 SCHNEIDEN KURZ STIRNRADIUS
- ① Fraise carbure, 2 dents, hémisphérique, courte
- ② 2 TAGLIENTI, SEMISFERICA, SERIE CORTA

- Suitable for dry milling applications at high temperatures.
- Excellent high-performance end mills.
- Designed for milling of radius bottom slots, fillets and special contours.

- Für die Trockenbearbeitung.
- Hervorragendes Preis - Leistungsverhältnis.
- Bestimmt für das Fräsen von Nuten mit konvexem Grund, Sonderprofilen und zum Kopieren.

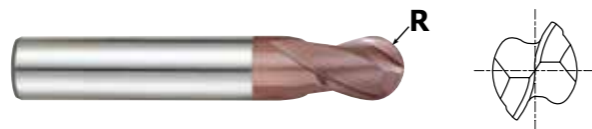

CARBIDE 2 30° R ±0.02 DIN 6535HA TiAlN p.C565

Flat Shank	Page	Plain Shank	Page
END MILL HOLDER	D118 - 137	HYDRAULIC CHUCK POWER MILLING CHUCK	D15 - 46 D161 - 176
-	-	SHRINK FIT HOLDER	D47 - 72
-	-	ER COLLET CHUCK SK SLIM CHUCK	D73 - 116 D183 - 201

Recommended ToolHolder

Unit : mm

EDP No.	Radius of Ball Nose R (±0.02)	Mill Diameter	Shank Diameter	Length of Cut	Overall Length
G9624020	R1.0	2.0	6	4	48
G9624025	R1.25	2.5	6	4	48
G9624030	R1.5	3.0	6	4	48
G9624040	R2.0	4.0	6	6	50
G9624901	R2.0	4.0	4	12	40
G9624050	R2.5	5.0	6	7	51
G9624902	R2.5	5.0	5	14	50
G9624060	R3.0	6.0	6	7	51
G9624080	R4.0	8.0	8	9	59
G9624100	R5.0	10.0	10	10	60
G9624120	R6.0	12.0	12	14	71
G9624140	R7.0	14.0	14	14	71
G9624160	R8.0	16.0	16	16	76
G9624180	R9.0	18.0	18	18	76
G9624200	R10.0	20.0	20	20	82

Mill Dia. Tolerance(mm)	Shank Dia. Tolerance
0 ~ - 0.03	h5

◎ : Excellent ○ : Good

ISO Material Description	P										M				K						
	Non-alloy steel					Low alloy steel					High alloyed steel, and tool steel				Stainless steel		Grey cast iron		Nodular cast iron		Malleable cast iron
VDI 3323	1	2	3	4	5	6	7	8	9	10	11	12	13	14	15	16	17	18	19	20	
HRc	13	25	28	32	38	40	45	50	55	60	65	70	75	80	85	90	95	100	105	110	
HB	125	190	250	270	300	180	275	300	350	200	325	200	240	180	180	260	160	250	130	230	
Recommend	◎	◎	◎	◎	◎	◎	◎	◎	◎	◎	◎	◎	◎	◎	◎	◎	◎	◎	◎	◎	

ISO Material Description	N										S				H						
	Aluminum-wrought alloy		Aluminum-cast, alloyed		Copper and Copper Alloys (Bronze / Brass)		Non Metallic Materials		Heat Resistant Super Alloys				Titanium Alloys		Hardened steel		Chilled Cast Iron		Hardened Cast Iron		
VDI 3323	21	22	23	24	25	26	27	28	29	30	31	32	33	34	35	36	37	38	39	40	41
HRc	21	22	23	24	25	26	27	28	29	30	31	32	33	34	35	36	37	38	39	40	41
HB	60	100	75	90	130	110	90	100			200	280	250	350	320	400 Rm	1050 Rm	550	630	400	550
Recommend	◎	◎	◎	◎	◎	◎	◎	◎	◎	◎	◎	◎	◎	◎	◎	◎	◎	◎	◎	◎	◎



PLAIN SHANK **G9A70** SERIES

CARBIDE, 2 FLUTE SHORT LENGTH BALL NOSE

- VOLLHARTMETALL, 2 SCHNEIDEN KURZ STIRNRADIUS
- ① Fraise carbure, 2 dents, hémisphérique, courte
- ② 2 TAGLIENTI, SEMISFERICA, SERIE CORTA

- Suitable for dry milling applications at high temperatures.
- Excellent high-performance end mills.
- Designed for milling of radius bottom slots, fillets and special contours.

- Für die Trockenbearbeitung.
- Hervorragendes Preis - Leistungsverhältnis.
- Bestimmt für das Fräsen von Nuten mit konvexem Grund, Sonderprofilen und zum Kopieren.



CARBIDE 2 30° R ±0.02 DIN 6535HA TiAlN p.C565

Flat Shank	Page	Plain Shank	Page
END MILL HOLDER	D118 - 137	HYDRAULIC CHUCK POWER MILLING CHUCK	D15 - 46 D161 - 176
-	-	SHRINK FIT HOLDER	D47 - 72
-	-	ER COLLET CHUCK SK SLIM CHUCK	D73 - 116 D183 - 201

Recommended ToolHolder

Unit : mm

EDP No.	Radius of Ball Nose R (±0.02)	Mill Diameter	Shank Diameter	Length of Cut	Overall Length
G9A70010	R0.5	1.0	3	3	39
G9A70015	R0.75	1.5	3	5	39
G9A70020	R1.0	2.0	3	7	39
G9A70025	R1.25	2.5	3	8	39
G9A70030	R1.5	3.0	3	9	39
G9A70040	R2.0	4.0	4	14	51
G9A70050	R2.5	5.0	5	16	51
G9A70060	R3.0	6.0	6	19	64
G9A70080	R4.0	8.0	8	21	64
G9A70100	R5.0	10.0	10	22	70
G9A70110	R5.5	11.0	11	25	70
G9A70120	R6.0	12.0	12	25	76
G9A70160	R8.0	16.0	16	32	89
G9A70200	R10.0	20.0	20	38	102

Mill Dia. Tolerance(mm)	Shank Dia. Tolerance
0 ~ - 0.03	h5

◎ : Excellent ○ : Good

ISO Material Description	P										M				K						
	Non-alloy steel					Low alloy steel					High alloyed steel, and tool steel				Stainless steel		Grey cast iron		Nodular cast iron		Malleable cast iron
VDI 3323	1	2	3	4	5	6	7	8	9	10	11	12	13	14	15	16	17	18	19	20	
HRc	13	25	28	32	38	40	45	50	55	60	65	70	75	80	85	90	95	100	105	110	
HB	125	190	250	270	300	180	275	300	350	200	325	200	240	180	180	260	160	250	130	230	
Recommend	◎	◎	◎	◎	◎	◎	◎	◎	◎	◎	◎	◎	◎	◎	◎	◎	◎	◎	◎	◎	

ISO Material Description	N										S				H						
	Aluminum-wrought alloy		Aluminum-cast, alloyed		Copper and Copper Alloys (Bronze / Brass)		Non Metallic Materials		Heat Resistant Super Alloys				Titanium Alloys		Hardened steel		Chilled Cast Iron		Hardened Cast Iron		
VDI 3323	21	22	23	24	25	26	27	28	29	30	31	32	33	34	35	36	37	38	39	40	41
HRc	21	22	23	24	25	26	27	28	29	30	31	32	33	34	35	36	37	38	39	40	41
HB	60	100	75	90	130	110	90	100			200	280	250	350	320	400 Rm	1050 Rm	550	630	400	550
Recommend	◎	◎	◎	◎	◎	◎	◎	◎	◎	◎	◎	◎	◎	◎	◎	◎	◎	◎	◎	◎	◎

CARBIDE, 2 FLUTE SHORT LENGTH BALL NOSE

- VOLLHARTMETALL, 2 SCHNEIDEN KURZ STIRNRADIUS
- (●) Fraise carbure, 2 dents, hémisphérique, courte
- (●) 2 TAGLIENTI, SEMISFERICA, SERIE CORTA

- Suitable for dry milling applications at high temperatures.
- Excellent high-performance end mills.
- Designed for milling of radius bottom slots, fillets and special contours.

- Für die Trockenbearbeitung.
- Hervorragendes Preis - Leistungsverhältnis.
- Bestimmt für das Fräsen von Nuten mit konvexem Grund, Sonderprofilen und zum Kopieren.



Flat Shank	Page	Plain Shank	Page
END MILL HOLDER	D118 - 137	HYDRAULIC CHUCK POWER MILLING CHUCK	D15 - 46 D161 - 176
-	-	SHRINK FIT HOLDER	D47 - 72
-	-	ER COLLET CHUCK SK SLIM CHUCK	D73 - 116 D183 - 201

Unit : mm

EDP No.	Radius of Ball Nose R (±0.02)	Mill Diameter	Shank Diameter	Length of Cut	Overall Length
G9437020	R1.0	2.0	6	3	50
G9437030	R1.5	3.0	6	4	50
G9437040	R2.0	4.0	6	5	54
G9437050	R2.5	5.0	6	6	54
G9437060	R3.0	6.0	6	7	54
G9437080	R4.0	8.0	8	9	58
G9437100	R5.0	10.0	10	11	66
G9437120	R6.0	12.0	12	12	73
G9437140	R7.0	14.0	14	14	75
G9437180	R9.0	18.0	18	18	84
G9437200	R10.0	20.0	20	20	92

Mill Dia. Tolerance(mm)	Shank Dia. Tolerance
0 ~ - 0.03	h5

◎ : Excellent ○ : Good

ISO Material Description	P					M				K										
	Non-alloy steel					Low alloy steel				High alloyed steel, and tool steel				Stainless steel	Grey cast iron	Nodular cast iron		Malleable cast iron		
VDI 3323	1	2	3	4	5	6	7	8	9	10	11	12	13	14	15	16	17	18	19	20
HRc	13	25	28	32	38	10	29	32	38	15	35	15	23	10	10	26	3	25	21	21
HB	125	190	250	270	300	180	275	300	350	200	325	200	240	180	180	260	160	250	130	230
Recommend	◎	◎	◎	◎	◎	◎	◎	◎	◎	◎	○	○	○	○	○	○	○	○	○	○

ISO Material Description	N					S					H										
	Aluminum-wrought alloy		Aluminum-cast, alloyed			Copper and Copper Alloys (Bronze / Brass)			Non Metallic Materials		Heat Resistant Super Alloys					Titanium Alloys		Hardened steel	Chilled Cast Iron		Hardened Cast Iron
VDI 3323	21	22	23	24	25	26	27	28	29	30	31	32	33	34	35	36	37	38	39	40	41
HRc	21	22	23	24	25	26	27	28	29	30	31	32	33	34	35	36	37	38	39	40	41
HB	60	100	75	90	130	110	90	100			200	280	250	350	320	400 Rm	1050 Rm	550	630	400	550
Recommend	○	○	○	○	○	○	○	○	○	○	○	○	○	○	○	○	○	○	○	○	○

CARBIDE, 2 FLUTE LONG LENGTH BALL NOSE

- VOLLHARTMETALL, 2 SCHNEIDEN LANG STIRNRADIUS
- (●) Fraise carbure, 2 dents, hémisphérique, longue
- (●) 2 TAGLIENTI, SEMISFERICA, SERIE LUNGA

- Suitable for dry milling applications at high temperatures.
- Excellent high-performance end mills.
- Designed for milling of radius bottom slots, fillets and special contours.

- Für die Trockenbearbeitung.
- Hervorragendes Preis - Leistungsverhältnis.
- Bestimmt für das Fräsen von Nuten mit konvexem Grund, Sonderprofilen und zum Kopieren.



Flat Shank	Page	Plain Shank	Page
END MILL HOLDER	D118 - 137	HYDRAULIC CHUCK POWER MILLING CHUCK	D15 - 46 D161 - 176
-	-	SHRINK FIT HOLDER	D47 - 72
-	-	ER COLLET CHUCK SK SLIM CHUCK	D73 - 116 D183 - 201

Unit : mm

EDP No.	Radius of Ball Nose R (±0.02)	Mill Diameter	Shank Diameter	Length of Cut	Overall Length
G9438020	R1.0	2.0	● 3	6	38
G9438030	R1.5	3.0	6	7	57
G9438040	R2.0	4.0	6	8	57
G9438050	R2.5	5.0	6	10	57
G9438060	R3.0	6.0	6	10	57
G9438080	R4.0	8.0	8	16	63
G9438100	R5.0	10.0	10	19	72
G9438120	R6.0	12.0	12	22	83
G9438140	R7.0	14.0	14	22	83
G9438160	R8.0	16.0	16	26	92
G9438180	R9.0	18.0	18	26	92
G9438200	R10.0	20.0	20	32	104

● with plain shank

Mill Dia. Tolerance(mm)	Shank Dia. Tolerance
0 ~ - 0.03	h5

◎ : Excellent ○ : Good

ISO Material Description	P					M				K										
	Non-alloy steel					Low alloy steel				High alloyed steel, and tool steel				Stainless steel	Grey cast iron	Nodular cast iron		Malleable cast iron		
VDI 3323	1	2	3	4	5	6	7	8	9	10	11	12	13	14	15	16	17	18	19	20
HRc	13	25	28	32	38	10	29	32	38	15	35	15	23	10	10	26	3	25	21	21
HB	125	190	250	270	300	180	275	300	350	200	325	200	240	180	180	260	160	250	130	230
Recommend	◎	◎	◎	◎	◎	◎	◎	◎	◎	◎	○	○	○	○	○	○	○	○	○	○

ISO Material Description	N					S					H										
	Aluminum-wrought alloy		Aluminum-cast, alloyed			Copper and Copper Alloys (Bronze / Brass)			Non Metallic Materials		Heat Resistant Super Alloys					Titanium Alloys		Hardened steel	Chilled Cast Iron		Hardened Cast Iron
VDI 3323	21	22	23	24	25	26	27	28	29	30	31	32	33	34	35	36	37	38	39	40	41
HRc	21	22	23	24	25	26	27	28	29	30	31	32	33	34	35	36	37	38	39	40	41
HB	60	100	75	90	130	110	90	100			200	280	250	350	320	400 Rm	1050 Rm	550	630	400	550
Recommend	○	○	○	○	○	○	○	○	○	○	○	○	○	○	○	○	○	○	○	○	○



PLAIN SHANK **G9454** SERIES

CARBIDE, 2 FLUTE LONG REACH BALL NOSE

- VOLLHARTMETALL, 2 SCHNEIDEN GROÙE REICHWEITE STIRNRADIUS
- Ⓞ Fraise carbure, 2 dents, hémisphérique longue portée
- Ⓞ 2 TAGLIENTI, SEMISFERICA, GAMBO LUNGO

- ▶ Suitable for dry milling applications at high temperatures.
- ▶ Excellent high-performance end mills.
- ▶ Designed for milling of radius bottom slots, fillets and special contours.
- ▶ Für die Trockenbearbeitung.
- ▶ Hervorragendes Preis - Leistungsverhältnis.
- ▶ Bestimmt für das Fräsen von Nuten mit konvexem Grund, Sonderprofilen und zum Kopieren.



CARBIDE 2 30° R ±0.02 DIN 6535HA TiAlN p.C565

Flat Shank	Page	Plain Shank	Page
END MILL HOLDER	D118 - 137	HYDRAULIC CHUCK POWER MILLING CHUCK	D15 - 46 D161 - 176
-	-	SHRINK FIT HOLDER	D47 - 72
-	-	ER COLLET CHUCK SK SLIM CHUCK	D73 - 116 D183 - 201

Recommended ToolHolder

Unit : mm

EDP No.	Radius of Ball Nose R (± 0.02)	Mill Diameter	Shank Diameter	Length of Cut	Overall Length
G9454030	R1.5	3.0	3	5	75
G9454040	R2.0	4.0	4	8	75
G9454050	R2.5	5.0	5	9	75
G9454060	R3.0	6.0	6	10	100
G9454080	R4.0	8.0	8	12	100
G9454100	R5.0	10.0	10	14	100
G9454120	R6.0	12.0	12	16	100
G9454140	R7.0	14.0	14	18	100
G9454160	R8.0	16.0	16	22	150
G9454200	R10.0	20.0	20	26	150

Mill Dia. Tolerance(mm)	Shank Dia. Tolerance
0 ~ - 0.03	h5

◎ : Excellent ○ : Good

ISO Material Description	P										M				K					
	Non-alloy steel					Low alloy steel					High alloyed steel, and tool steel		Stainless steel		Grey cast iron		Nodular cast iron		Malleable cast iron	
VDI 3323	1	2	3	4	5	6	7	8	9	10	11	12	13	14	15	16	17	18	19	20
HRc	13	25	28	32	38	10	29	32	38	45	15	35	40	48	10	26	3	25	21	21
HB	125	190	250	270	300	180	275	300	350	200	325	200	240	180	180	260	160	250	130	230
Recommend	◎	◎	◎	◎	◎	◎	◎	◎	◎	◎	◎	◎	◎	◎	◎	◎	◎	◎	◎	◎

ISO Material Description	N					S					H										
	Aluminum-wrought alloy		Aluminum-cast, alloyed			Copper and Copper Alloys (Bronze / Brass)		Non Metallic Materials			Heat Resistant Super Alloys					Titanium Alloys		Hardened steel	Chilled Cast Iron	Hardened Cast Iron	
VDI 3323	21	22	23	24	25	26	27	28	29	30	31	32	33	34	35	36	37	38	39	40	41
HRc	21	22	23	24	25	26	27	28	29	30	31	32	33	34	35	36	37	38	39	40	41
HB	60	100	75	90	130	110	90	100			200	280	250	350	320	400 Rm	1050 Rm	550	630	400	550
Recommend	◎	◎	◎	◎	◎	◎	◎	◎	◎	◎	◎	◎	◎	◎	◎	◎	◎	◎	◎	◎	◎



PLAIN SHANK **G9455** SERIES

CARBIDE, 2 FLUTE EXTRA LONG LENGTH BALL NOSE

- VOLLHARTMETALL, 2 SCHNEIDEN EXTRA LANG STIRNRADIUS
- Ⓞ Fraise carbure, 2 dents, hémisphérique, extra-longue
- Ⓞ 2 TAGLIENTI, SEMISFERICA, SERIE EXTRA LUNGA

- ▶ Suitable for dry milling applications at high temperatures.
- ▶ Excellent high-performance end mills.
- ▶ Designed for milling of radius bottom slots, fillets and special contours.
- ▶ Für die Trockenbearbeitung.
- ▶ Hervorragendes Preis - Leistungsverhältnis.
- ▶ Bestimmt für das Fräsen von Nuten mit konvexem Grund, Sonderprofilen und zum Kopieren.



CARBIDE 2 30° R ±0.02 DIN 6535HA TiAlN p.C565

Flat Shank	Page	Plain Shank	Page
END MILL HOLDER	D118 - 137	HYDRAULIC CHUCK POWER MILLING CHUCK	D15 - 46 D161 - 176
-	-	SHRINK FIT HOLDER	D47 - 72
-	-	ER COLLET CHUCK SK SLIM CHUCK	D73 - 116 D183 - 201

Recommended ToolHolder

Unit : mm

EDP No.	Radius of Ball Nose R (± 0.02)	Mill Diameter	Shank Diameter	Length of Cut	Overall Length
G9455903	R1.5	3.0	3	20	60
G9455030	R1.5	3.0	3	30	75
G9455904	R2.0	4.0	4	20	60
G9455040	R2.0	4.0	4	30	75
G9455905	R2.5	5.0	5	25	75
G9455050	R2.5	5.0	5	40	100
G9455906	R3.0	6.0	6	30	75
G9455060	R3.0	6.0	6	50	150
G9455908	R4.0	8.0	8	30	75
G9455080	R4.0	8.0	8	50	150
G9455910	R5.0	10.0	10	40	100
G9455100	R5.0	10.0	10	60	150
G9455912	R6.0	12.0	12	45	100
G9455120	R6.0	12.0	12	75	150
G9455914	R7.0	14.0	14	45	100
G9455140	R7.0	14.0	14	75	150
G9455916	R8.0	16.0	16	45	100
G9455160	R8.0	16.0	16	75	150
G9455918	R9.0	18.0	18	45	100
G9455180	R9.0	18.0	18	75	150
G9455920	R10.0	20.0	20	45	100
G9455200	R10.0	20.0	20	75	150

Mill Dia. Tolerance(mm)	Shank Dia. Tolerance
0 ~ - 0.03	h5

◎ : Excellent ○ : Good

ISO Material Description	P										M				K					
	Non-alloy steel					Low alloy steel					High alloyed steel, and tool steel		Stainless steel		Grey cast iron		Nodular cast iron		Malleable cast iron	
VDI 3323	1	2	3	4	5	6	7	8	9	10	11	12	13	14	15	16	17	18	19	20
HRc	13	25	28	32	38	10	29	32	38	45	15	35	40	48	10	26	3	25	21	21
HB	125	190	250	270	300	180	275	300	350	200	325	200	240	180	180	260	160	250	130	230
Recommend	◎	◎	◎	◎	◎	◎	◎	◎	◎	◎	◎	◎	◎	◎	◎	◎	◎	◎	◎	◎

ISO Material Description	N					S					H										
	Aluminum-wrought alloy		Aluminum-cast, alloyed			Copper and Copper Alloys (Bronze / Brass)		Non Metallic Materials			Heat Resistant Super Alloys					Titanium Alloys		Hardened steel	Chilled Cast Iron	Hardened Cast Iron	
VDI 3323	21	22	23	24	25	26	27	28	29	30	31	32	33	34	35	36	37	38	39	40	41
HRc	21	22	23	24	25	26	27	28	29	30	31	32	33	34	35	36	37	38	39	40	41
HB	60	100	75	90	130	110	90	100			200	280	250	350	320	400 Rm	1050 Rm	550	630	400	550
Recommend	◎	◎	◎	◎	◎	◎	◎	◎	◎	◎	◎	◎	◎	◎	◎	◎	◎	◎	◎	◎	◎

HSS

HSS



PLAIN SHANK **G9B81** SERIES



PLAIN SHANK **G9B81** SERIES

CARBIDE, 2 FLUTE BALL NOSE for RIB PROCESSING

- VOLLHARTMETALL, 2 SCHNEIDEN STIRNRADIUS für SCHMALE RIPPEN
- (●) Fraise carbure, 2 dents, hémisphérique pour usinage de rainure
- (●) 2 TAGLIENTI, SEMISFERICA, SCARICATA PER NERVATURE

- Suitable for dry milling applications at high temperatures.
- Excellent high-performance end mills.
- Designed for milling of radius bottom slots, fillets and special contours.
- Für die Trockenbearbeitung.
- Hervorragendes Preis - Leistungsverhältnis.
- Bestimmt für das Fräsen von Nuten mit konvexem Grund, Sonderprofilen und zum Kopieren.

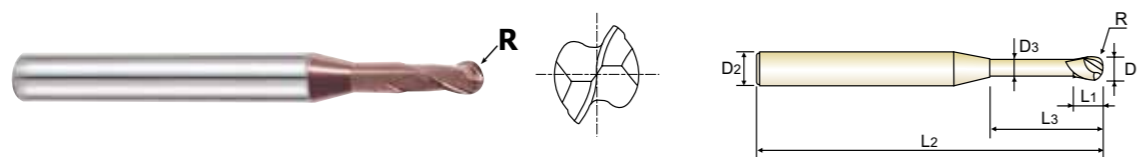

CARBIDE 2 30° R ±0.02 DIN 6535HA TiAlN p.C566-567

Flat Shank	Page	Plain Shank	Page
END MILL HOLDER	D118 - 137	HYDRAULIC CHUCK POWER MILLING CHUCK	D15 - 46 D161 - 176
-	-	SHRINK FIT HOLDER	D47 - 72
-	-	ER COLLET CHUCK SK SLIM CHUCK	D73 - 116 D183 - 201

Recommended ToolHolder

CARBIDE 2 30° R ±0.02 DIN 6535HA TiAlN p.C566-567

Flat Shank	Page	Plain Shank	Page
END MILL HOLDER	D118 - 137	HYDRAULIC CHUCK POWER MILLING CHUCK	D15 - 46 D161 - 176
-	-	SHRINK FIT HOLDER	D47 - 72
-	-	ER COLLET CHUCK SK SLIM CHUCK	D73 - 116 D183 - 201

Recommended ToolHolder

Unit : mm

EDP No.	Radius of Ball Nose R (±0.02)	Mill Diameter D1	Shank Diameter D2	Length of Cut L1	Length Below Shank L3	Overall Length D3	Neck Diameter D3
G9B81004	R0.2	0.4	4	0.7	2	50	0.37
G9B81005	R0.25	0.5	4	0.75	2	50	0.45
G9B81901	R0.25	0.5	4	0.75	4	50	0.45
G9B81902	R0.25	0.5	4	0.75	6	50	0.45
G9B81006	R0.3	0.6	4	0.9	2	50	0.55
G9B81903	R0.3	0.6	4	0.9	4	50	0.55
G9B81904	R0.3	0.6	4	0.9	6	50	0.55
G9B81008	R0.4	0.8	4	1.2	4	50	0.75
G9B81905	R0.4	0.8	4	1.2	6	50	0.75
G9B81906	R0.4	0.8	4	1.2	8	50	0.75
G9B81010	R0.5	1.0	4	1.5	6	50	0.95
G9B81907	R0.5	1.0	4	1.5	8	50	0.95
G9B81908	R0.5	1.0	4	1.5	10	50	0.95
G9B81909	R0.5	1.0	4	1.5	12	50	0.95
G9B81012	R0.6	1.2	4	1.8	8	50	1.15
G9B81910	R0.6	1.2	4	1.8	12	50	1.15
G9B81014	R0.7	1.4	4	2.1	16	50	1.35
G9B81015	R0.75	1.5	4	2.3	6	50	1.45
G9B81911	R0.75	1.5	4	2.3	8	50	1.45
G9B81912	R0.75	1.5	4	2.3	10	50	1.45
G9B81913	R0.75	1.5	4	2.3	12	50	1.45
G9B81914	R0.75	1.5	4	2.3	16	50	1.45
G9B81915	R0.75	1.5	4	2.3	20	50	1.45
G9B81016	R0.8	1.6	4	2.4	8	50	1.55

Unit : mm

EDP No.	Radius of Ball Nose R (±0.02)	Mill Diameter D1	Shank Diameter D2	Length of Cut L1	Length Below Shank L3	Overall Length D3	Neck Diameter D3
G9B81916	R0.8	1.6	4	2.4	12	50	1.55
G9B81917	R0.8	1.6	4	2.4	16	50	1.55
G9B81918	R0.8	1.6	4	2.4	20	50	1.55
G9B81020	R1.0	2.0	4	3	8	50	1.95
G9B81919	R1.0	2.0	4	3	10	50	1.95
G9B81920	R1.0	2.0	4	3	12	50	1.95
G9B81921	R1.0	2.0	4	3	14	50	1.95
G9B81922	R1.0	2.0	4	3	16	50	1.95
G9B81923	R1.0	2.0	4	3	20	50	1.95
G9B81030	R1.5	3.0	6	4.5	10	50	2.85
G9B81924	R1.5	3.0	6	4.5	12	50	2.85
G9B81925	R1.5	3.0	6	4.5	16	60	2.85
G9B81926	R1.5	3.0	6	4.5	20	60	2.85
G9B81927	R1.5	3.0	6	4.5	25	75	2.85
G9B81040	R2.0	4.0	6	6	12	50	3.85
G9B81928	R2.0	4.0	6	6	16	60	3.85
G9B81929	R2.0	4.0	6	6	20	75	3.85
G9B81930	R2.0	4.0	6	6	25	75	3.85
G9B81931	R2.0	4.0	6	6	30	75	3.85

Mill Dia. Tolerance(mm)	Shank Dia. Tolerance
0 ~ - 0.03	h5

► NEXT PAGE

Mill Dia. Tolerance(mm)	Shank Dia. Tolerance
0 ~ - 0.03	h5

◎ : Excellent ○ : Good

ISO Material Description	P										M							K				
	Non-alloy steel					Low alloy steel					High alloyed steel, and tool steel		Stainless steel			Grey cast iron		Nodular cast iron		Malleable cast iron		
VDI 3323	1	2	3	4	5	6	7	8	9	10	11	12	13	14	15	16	17	18	19	20		
HRc	13	25	28	32	30	10	29	32	38	15	35	15	23	10	10	26	3	25	21	21		
HB	125	190	250	270	300	180	275	300	350	200	325	200	240	180	180	260	160	250	130	230		
Recommend	◎	◎	◎	◎	◎	◎	◎	◎	◎	◎	◎	◎	◎	◎	◎	◎	◎	◎	◎	◎	◎	

ISO Material Description	N					S					H											
	Aluminum-wrought alloy		Aluminum-cast, alloyed		Copper and Copper Alloys (Bronze / Brass)	Non Metallic Materials		Heat Resistant Super Alloys			Titanium Alloys		Hardened steel	Chilled Cast Iron	Hardened Cast Iron							
VDI 3323	21	22	23	24	25	26	27	28	29	30	31	32	33	34	35	36	37	38	39	40	41	
HRc	15	30	25	38	34						15	30	25	38	34	400 Rm	1050 Rm	55	60	42	55	
HB	60	100	75	90	130	110	90	100			200	280	250	350	320	400 Rm	1050 Rm	550	630	400	550	
Recommend	◎	◎	◎	◎	◎	◎	◎	◎	◎	◎	◎	◎	◎	◎	◎	◎	◎	◎	◎	◎	◎	◎

◎ : Excellent ○ : Good

ISO Material Description	P										M							K				
	Non-alloy steel					Low alloy steel					High alloyed steel, and tool steel		Stainless steel			Grey cast iron		Nodular cast iron		Malleable cast iron		
VDI 3323	1	2	3	4	5	6	7	8	9	10	11	12	13	14	15	16	17	18	19	20		
HRc	13	25	28	32	30	10	29	32	38	15	35	15	23	10	10	26	3	25	21	21		
HB	125	190	250	270	300	180	275	300	350	200	325	200	240	180	180	260	160	250	130	230		
Recommend	◎	◎	◎	◎	◎	◎	◎	◎	◎	◎	◎	◎	◎	◎	◎	◎	◎	◎	◎	◎	◎	

ISO Material Description	N					S					H											
	Aluminum-wrought alloy		Aluminum-cast, alloyed		Copper and Copper Alloys (Bronze / Brass)	Non Metallic Materials		Heat Resistant Super Alloys			Titanium Alloys		Hardened steel	Chilled Cast Iron	Hardened Cast Iron							
VDI 3323	21	22	23	24	25	26	27	28	29	30	31	32	33	34	35	36	37	38	39	40	41	
HRc	15	30	25	38	34						15	30	25	38	34	400 Rm	1050 Rm	55	60	42	55	
HB	60	100	75	90	130	110	90	100			200	280	250	350	320	400 Rm	1050 Rm	550	630	400	550	
Recommend	◎	◎	◎	◎	◎	◎	◎	◎	◎	◎	◎	◎	◎	◎	◎	◎	◎	◎	◎	◎	◎	◎

CARBIDE, 4 FLUTE SHORT LENGTH BALL NOSE

- VOLLHARTMETALL, 4 SCHNEIDEN KURZ STIRNRADIUS
- Fraise carbure, 4 dents, hémisphérique, courte
- 4 TAGLIENTI, SEMISFERICA, SERIE CORTA

- Suitable for dry milling applications at high temperatures.
- Excellent high-performance end mills.
- 4 flute allows for better work piece finishes.
- Designed for milling of radius bottom slots, fillets and special contours.

- Für die Trockenbearbeitung.
- Hervorragendes Preis - Leistungsverhältnis.
- 4 Schneiden erzeugen eine bessere Oberflächengüte des Werkstücks.
- Bestimmt für das Fräsen von Nuten mit konvexem Grund, Sonderprofilen und zum Kopieren.



CARBIDE
4
30°
±0.02
DIN 6535HA
TiAlN
p.C568

Flat Shank	Page	Plain Shank	Page
END MILL HOLDER	D118 - 137	HYDRAULIC CHUCK POWER MILLING CHUCK	D15 - 46 D161 - 176
-	-	SHRINK FIT HOLDER	D47 - 72
-	-	ER COLLET CHUCK SK SLIM CHUCK	D73 - 116 D183 - 201

Recommended ToolHolder

Unit : mm

EDP No.	Radius of Ball Nose R (±0.02)	Mill Diameter	Shank Diameter	Length of Cut	Overall Length
G9634020	R1.0	2.0	6	4	48
G9634030	R1.5	3.0	6	4	48
G9634040	R2.0	4.0	6	6	50
G9634050	R2.5	5.0	6	7	51
G9634060	R3.0	6.0	6	7	51
G9634080	R4.0	8.0	8	9	59
G9634100	R5.0	10.0	10	10	60
G9634120	R6.0	12.0	12	14	71
G9634140	R7.0	14.0	14	14	71
G9634160	R8.0	16.0	16	16	76
G9634180	R9.0	18.0	18	18	76
G9634200	R10.0	20.0	20	20	82

Mill Dia. Tolerance(mm)	Shank Dia. Tolerance
0 ~ - 0.03	h5

◎ : Excellent ○ : Good

ISO Material Description	P										M				K						
	Non-alloy steel					Low alloy steel					High alloyed steel, and tool steel		Stainless steel		Grey cast iron	Nodular cast iron		Malleable cast iron			
VDI 3323	1	2	3	4	5	6	7	8	9	10	11	12	13	14	15	16	17	18	19	20	
HRc	13	25	28	32	38	10	29	32	38	15	35	15	23	10	10	26	3	25	21		
HB	125	190	250	270	300	180	275	300	350	200	325	200	240	180	180	260	160	250	130	230	
Recommend	◎	◎	◎	◎	◎	◎	◎	◎	◎	◎	◎	○	○	○	○	○	○	○	○	○	○

ISO Material Description	N					S					H											
	Aluminum-wrought alloy		Aluminum-cast, alloyed		Copper and Copper Alloys (Bronze / Brass)	Non Metallic Materials		Heat Resistant Super Alloys			Titanium Alloys		Hardened steel	Chilled Cast Iron	Hardened Cast Iron							
VDI 3323	21	22	23	24	25	26	27	28	29	30	31	32	33	34	35	36	37	38	39	40	41	
HRc																						
HB	60	100	75	90	130	110	90	100			200	280	250	350	320	400 Rm	1050 Rm	550	630	400	550	
Recommend	○	○	○	○	○	○	○	○	○	○	○	○	○	○	○	○	○	○	○	○	○	○

CARBIDE, 2 FLUTE SHORT LENGTH CORNER RADIUS

- VOLLHARTMETALL, 2 SCHNEIDEN KURZ ECKENRADIUS
- Fraise carbure, 2 dents, torique, courte
- 2 TAGLIENTI, SERIE CORTA, TORICA

- Suitable for dry milling applications at high temperatures.
- Excellent high-performance end mills.
- 2 flute design for slotting.

- Für die Trockenbearbeitung.
- Hervorragendes Preis - Leistungsverhältnis.
- 2 Schneiden zum Nutenfräsen.



CARBIDE
2
30°
±0.02
DIN 6535HA
TiAlN
p.C569

Flat Shank	Page	Plain Shank	Page
END MILL HOLDER	D118 - 137	HYDRAULIC CHUCK POWER MILLING CHUCK	D15 - 46 D161 - 176
-	-	SHRINK FIT HOLDER	D47 - 72
-	-	ER COLLET CHUCK SK SLIM CHUCK	D73 - 116 D183 - 201

Recommended ToolHolder

Unit : mm

EDP No.	Corner Radius R	Mill Diameter	Shank Diameter	Length of Cut	Overall Length
G9B82020	R0.2	2.0	4	4	50
G9B82901	R0.3	2.0	4	4	50
G9B82902	R0.5	2.0	4	4	50
G9B82025	R0.2	2.5	4	5	50
G9B82903	R0.3	2.5	4	5	50
G9B82904	R0.5	2.5	4	5	50
G9B82030	R0.2	3.0	4	6	50
G9B82905	R0.3	3.0	4	6	50
G9B82906	R0.5	3.0	4	6	50
G9B82907	R1.0	3.0	4	6	50
G9B82040	R0.2	4.0	4	8	50
G9B82908	R0.3	4.0	4	8	50
G9B82909	R0.5	4.0	4	8	50
G9B82910	R1.0	4.0	4	8	50
G9B82050	R0.2	5.0	6	10	50
G9B82911	R0.3	5.0	6	10	50
G9B82912	R0.5	5.0	6	10	50
G9B82913	R1.0	5.0	6	10	50
G9B82060	R0.2	6.0	6	12	50
G9B82914	R0.3	6.0	6	12	50
G9B82915	R0.5	6.0	6	12	50
G9B82916	R1.0	6.0	6	12	50

Mill Dia. Tolerance(mm)	Shank Dia. Tolerance
0 ~ - 0.03	h5

◎ : Excellent ○ : Good

ISO Material Description	P										M				K						
	Non-alloy steel					Low alloy steel					High alloyed steel, and tool steel		Stainless steel		Grey cast iron	Nodular cast iron		Malleable cast iron			
VDI 3323	1	2	3	4	5	6	7	8	9	10	11	12	13	14	15	16	17	18	19	20	
HRc	13	25	28	32	38	10	29	32	38	15	35	15	23	10	10	26	3	25	21		
HB	125	190	250	270	300	180	275	300	350	200	325	200	240	180	180	260	160	250	130	230	
Recommend	◎	◎	◎	◎	◎	◎	◎	◎	◎	◎	◎	○	○	○	○	○	○	○	○	○	○

ISO Material Description	N					S					H											
	Aluminum-wrought alloy		Aluminum-cast, alloyed		Copper and Copper Alloys (Bronze / Brass)	Non Metallic Materials		Heat Resistant Super Alloys			Titanium Alloys		Hardened steel	Chilled Cast Iron	Hardened Cast Iron							
VDI 3323	21	22	23	24	25	26	27	28	29	30	31	32	33	34	35	36	37	38	39	40	41	
HRc																						
HB	60	100	75	90	130	110	90	100			200	280	250	350	320	400 Rm	1050 Rm	550	630	400	550	
Recommend	○	○	○	○	○	○	○	○	○	○	○	○	○	○	○	○	○	○	○	○	○	○



PLAIN SHANK **G9B82** SERIES

CARBIDE, 2 FLUTE SHORT LENGTH CORNER RADIUS

VOLLHARTMETALL, 2 SCHNEIDEN KURZ ECKENRADIUS
 (Fraise carbure, 2 dents, torique, courte)
 (2 TAGLIENTI, SERIE CORTA, TORICA)

- Suitable for dry milling applications at high temperatures.
- Excellent high-performance end mills.
- 2 flute design for slotting.

- Für die Trockenbearbeitung.
- Hervorragendes Preis - Leistungsverhältnis.
- 2 Schneiden zum Nutenfräsen.



CARBIDE 2 30° DIN 6535HA TiAIN p.C569

Flat Shank	Page	Plain Shank	Page
END MILL HOLDER	D118 - 137	HYDRAULIC CHUCK POWER MILLING CHUCK	D15 - 46 D161 - 176
-	-	SHRINK FIT HOLDER	D47 - 72
-	-	ER COLLET CHUCK SK SLIM CHUCK	D73 - 116 D183 - 201

Unit : mm

EDP No.	Corner Radius R	Mill Diameter	Shank Diameter	Length of Cut	Overall Length
G9B82080	R0.5	8.0	8	16	60
G9B82917	R1.0	8.0	8	16	60
G9B82918	R1.5	8.0	8	16	60
G9B82919	R2.0	8.0	8	16	60
G9B82920	R2.5	8.0	8	16	60
G9B82100	R0.5	10.0	10	20	75
G9B82921	R1.0	10.0	10	20	75
G9B82922	R1.5	10.0	10	20	75
G9B82923	R2.0	10.0	10	20	75
G9B82924	R2.5	10.0	10	20	75
G9B82120	R0.5	12.0	12	24	75
G9B82925	R1.0	12.0	12	24	75
G9B82926	R1.5	12.0	12	24	75
G9B82927	R2.0	12.0	12	24	75
G9B82928	R2.5	12.0	12	24	75

Mill Dia. Tolerance(mm)	Shank Dia. Tolerance
0 ~ - 0.03	h5

◎ : Excellent ○ : Good

ISO Material Description	P										M				K						
	Non-alloy steel					Low alloy steel					High alloyed steel, and tool steel				Stainless steel		Grey cast iron		Nodular cast iron		Malleable cast iron
VDI 3323	1	2	3	4	5	6	7	8	9	10	11	12	13	14	15	16	17	18	19	20	
HRc	13	25	28	32	38	40	42	45	48	50	52	55	58	60	62	65	68	70	72	75	
HB	125	190	250	270	300	180	275	300	350	200	325	200	240	180	180	260	160	250	130	230	
Recommend	◎	◎	◎	◎	◎	◎	◎	◎	◎	◎	◎	◎	◎	◎	◎	◎	◎	◎	◎	◎	◎

ISO Material Description	N					S					H											
	Aluminum-wrought alloy		Aluminum-cast, alloyed			Copper and Copper Alloys (Bronze / Brass)		Non Metallic Materials			Heat Resistant Super Alloys					Titanium Alloys		Hardened steel		Chilled Cast Iron		Hardened Cast Iron
VDI 3323	21	22	23	24	25	26	27	28	29	30	31	32	33	34	35	36	37	38	39	40	41	
HRc	21	22	23	24	25	26	27	28	29	30	31	32	33	34	35	36	37	38	39	40	41	
HB	60	100	75	90	130	110	90	100			200	280	250	350	320	400 Rm	1050 Rm	550	630	400	550	
Recommend	◎	◎	◎	◎	◎	◎	◎	◎	◎	◎	◎	◎	◎	◎	◎	◎	◎	◎	◎	◎	◎	◎



PLAIN SHANK **G9B83** SERIES

CARBIDE, 2 FLUTE LONG REACH CORNER RADIUS

VOLLHARTMETALL, 2 SCHNEIDEN GROÙE REICHWEITE ECKENRADIUS
 (Fraise carbure, 2 dents, torique longue portée)
 (2 TAGLIENTI, SERIE LUNGA, TORICA)

- Suitable for dry milling applications at high temperatures.
- Excellent high-performance end mills.
- 2 flute design for slotting.

- Für die Trockenbearbeitung.
- Hervorragendes Preis - Leistungsverhältnis.
- 2 Schneiden zum Nutenfräsen.



CARBIDE 2 30° DIN 6535HA TiAIN p.C569

Flat Shank	Page	Plain Shank	Page
END MILL HOLDER	D118 - 137	HYDRAULIC CHUCK POWER MILLING CHUCK	D15 - 46 D161 - 176
-	-	SHRINK FIT HOLDER	D47 - 72
-	-	ER COLLET CHUCK SK SLIM CHUCK	D73 - 116 D183 - 201

Unit : mm

EDP No.	Corner Radius R	Mill Diameter	Shank Diameter	Length of Cut	Overall Length
G9B83030	R0.5	3.0	4	6	75
G9B83901	R1.0	3.0	4	6	75
G9B83040	R0.5	4.0	4	8	75
G9B83902	R1.0	4.0	4	8	75
G9B83050	R0.5	5.0	6	10	75
G9B83903	R1.0	5.0	6	10	75
G9B83060	R0.5	6.0	6	12	75
G9B83904	R1.0	6.0	6	12	75
G9B83080	R0.5	8.0	8	16	100
G9B83905	R1.0	8.0	8	16	100
G9B83906	R1.5	8.0	8	16	100
G9B83907	R2.0	8.0	8	16	100
G9B83908	R2.5	8.0	8	16	100
G9B83100	R0.5	10.0	10	20	100
G9B83909	R1.0	10.0	10	20	100
G9B83910	R1.5	10.0	10	20	100
G9B83911	R2.0	10.0	10	20	100
G9B83912	R2.5	10.0	10	20	100
G9B83120	R0.5	12.0	12	24	100
G9B83913	R1.0	12.0	12	24	100
G9B83914	R1.5	12.0	12	24	100
G9B83915	R2.0	12.0	12	24	100
G9B83916	R2.5	12.0	12	24	100

Mill Dia. Tolerance(mm)	Shank Dia. Tolerance
0 ~ - 0.03	h5

◎ : Excellent ○ : Good

ISO Material Description	P										M				K						
	Non-alloy steel					Low alloy steel					High alloyed steel, and tool steel				Stainless steel		Grey cast iron		Nodular cast iron		Malleable cast iron
VDI 3323	1	2	3	4	5	6	7	8	9	10	11	12	13	14	15	16	17	18	19	20	
HRc	13	25	28	32	38	40	42	45	48	50	52	55	58	60	62	65	68	70	72	75	
HB	125	190	250	270	300	180	275	300	350	200	325	200	240	180	180	260	160	250	130	230	
Recommend	◎	◎	◎	◎	◎	◎	◎	◎	◎	◎	◎	◎	◎	◎	◎	◎	◎	◎	◎	◎	◎

ISO Material Description	N					S					H											
	Aluminum-wrought alloy		Aluminum-cast, alloyed			Copper and Copper Alloys (Bronze / Brass)		Non Metallic Materials			Heat Resistant Super Alloys					Titanium Alloys		Hardened steel		Chilled Cast Iron		Hardened Cast Iron
VDI 3323	21	22	23	24	25	26	27	28	29	30	31	32	33	34	35	36	37	38	39	40	41	
HRc	21	22	23	24	25	26	27	28	29	30	31	32	33	34	35	36	37	38	39	40	41	
HB	60	100	75	90	130	110	90	100			200	280	250	350	320	400 Rm	1050 Rm	550	630	400	550	
Recommend	◎	◎	◎	◎	◎	◎	◎	◎	◎	◎	◎	◎	◎	◎	◎	◎	◎	◎	◎	◎	◎	◎



PLAIN SHANK G9B84 SERIES

CARBIDE, 4 FLUTE SHORT LENGTH CORNER RADIUS

- VOLLHARTMETALL, 4 SCHNEIDEN KURZ ECKENRADIUS
Fraise carbure, 4 dents, torique, courte
4 TAGLIENTI, SERIE CORTA, TORICA

- Suitable for dry milling applications at high temperatures.
Excellent high-performance end mills.
Designed for milling of radius bottom slots, fillets and special contours.

- Für die Trockenbearbeitung.
Hervorragendes Preis - Leistungsverhältnis.
Bestimmt für das Fräsen von Nuten mit konvexem Grund, Sonderprofilen und zum Kopieren.



Table with 4 columns: Flat Shank, Page, Plain Shank, Page. Lists tool holder types and their corresponding page numbers.

Unit : mm

Main product table with columns: EDP No., Corner Radius R, Mill Diameter, Shank Diameter, Length of Cut, Overall Length. Lists various end mill specifications.

▶ NEXT PAGE

Table with 2 columns: Mill Dia. Tolerance(mm), Shank Dia. Tolerance. Values: 0 ~ - 0.03, h5

◎ : Excellent ○ : Good

Material compatibility chart with columns for ISO, Material Description, and various material groups (P, M, K, N, S, H).



PLAIN SHANK G9B84 SERIES

CARBIDE, 4 FLUTE SHORT LENGTH CORNER RADIUS

- VOLLHARTMETALL, 4 SCHNEIDEN KURZ ECKENRADIUS
Fraise carbure, 4 dents, torique, courte
4 TAGLIENTI, SERIE CORTA, TORICA

- Suitable for dry milling applications at high temperatures.
Excellent high-performance end mills.
Designed for milling of radius bottom slots, fillets and special contours.

- Für die Trockenbearbeitung.
Hervorragendes Preis - Leistungsverhältnis.
Bestimmt für das Fräsen von Nuten mit konvexem Grund, Sonderprofilen und zum Kopieren.



Table with 4 columns: Flat Shank, Page, Plain Shank, Page. Lists tool holder types and their corresponding page numbers.

Unit : mm

Main product table with columns: EDP No., Corner Radius R, Mill Diameter, Shank Diameter, Length of Cut, Overall Length. Lists various end mill specifications.

Table with 2 columns: Mill Dia. Tolerance(mm), Shank Dia. Tolerance. Values: 0 ~ - 0.03, h5

◎ : Excellent ○ : Good

Material compatibility chart with columns for ISO, Material Description, and various material groups (P, M, K, N, S, H).



PLAIN SHANK **G9B85** SERIES

CARBIDE, 4 FLUTE LONG REACH CORNER RADIUS

- VOLLHARTMETALL, 4 SCHNEIDEN GROÙE REICHWEITE ECKENRADIUS
- ④ Fraise carbure, 4 dents, torique longue portée
- ④ 4 TAGLIENTI, SERIE LUNGA, TORICA

- ▶ Suitable for dry milling applications at high temperatures.
- ▶ Excellent high-performance end mills.
- ▶ Designed for milling of radius bottom slots, fillets and special contours.

- ▶ Für die Trockenbearbeitung.
- ▶ Hervorragendes Preis - Leistungsverhältnis.
- ▶ Bestimmt für das Fräsen von Nuten mit konvexem Grund, Sonderprofilen und zum Kopieren.



	Flat Shank	Page	Plain Shank	Page
④	END MILL HOLDER	D118 - 137	HYDRAULIC CHUCK POWER MILLING CHUCK	D15 - 46 D161 - 176
④	-	-	SHRINK FIT HOLDER	D47 - 72
④	-	-	ER COLLET CHUCK SK SLIM CHUCK	D73 - 116 D183 - 201

Unit : mm

EDP No.	Corner Radius R	Mill Diameter	Shank Diameter	Length of Cut	Overall Length
G9B85030	R0.5	3.0	4	6	75
G9B85901	R1.0	3.0	4	6	75
G9B85040	R0.5	4.0	4	8	75
G9B85902	R1.0	4.0	4	8	75
G9B85050	R0.5	5.0	6	10	75
G9B85903	R1.0	5.0	6	10	75
G9B85060	R0.5	6.0	6	12	75
G9B85904	R1.0	6.0	6	12	75
G9B85080	R0.5	8.0	8	16	100
G9B85905	R1.0	8.0	8	16	100
G9B85906	R1.5	8.0	8	16	100
G9B85907	R2.0	8.0	8	16	100
G9B85908	R2.5	8.0	8	16	100
G9B85100	R0.5	10.0	10	20	100
G9B85909	R1.0	10.0	10	20	100
G9B85910	R1.5	10.0	10	20	100
G9B85911	R2.0	10.0	10	20	100
G9B85912	R2.5	10.0	10	20	100
G9B85120	R0.5	12.0	12	24	100
G9B85913	R1.0	12.0	12	24	100
G9B85914	R1.5	12.0	12	24	100
G9B85915	R2.0	12.0	12	24	100
G9B85916	R2.5	12.0	12	24	100

Mill Dia. Tolerance(mm)	Shank Dia. Tolerance
0 ~ - 0.03	h5

ISO Material Description	P										M				K					
	Non-alloy steel					Low alloy steel					High alloyed steel, and tool steel		Stainless steel		Grey cast iron		Nodular cast iron		Malleable cast iron	
VDI 3323	1	2	3	4	5	6	7	8	9	10	11	12	13	14	15	16	17	18	19	20
HRc	13	25	28	32	38	10	29	32	38	45	15	23	10	10	10	26	3	25	21	21
HB	125	190	250	270	300	180	275	300	350	200	200	240	180	180	180	260	160	250	130	230
Recommend	⊙	⊙	⊙	⊙	⊙	⊙	⊙	⊙	⊙	⊙	○	○	○	○	○	○	○	○	○	○



PLAIN SHANK **G9424** SERIES

CARBIDE, 2 FLUTE SHORT LENGTH

- VOLLHARTMETALL, 2 SCHNEIDEN KURZ
- ② Fraise carbure, 2 dents, courte
- ② 2 TAGLIENTI, CORTA

- ▶ Suitable for dry milling applications at high temperatures.
- ▶ Excellent high-performance end mills.
- ▶ 2 flute design for slotting.

- ▶ Für die Trockenbearbeitung.
- ▶ Hervorragendes Preis - Leistungsverhältnis.
- ▶ 2 Schneiden zum Nutenfräsen.



	Flat Shank	Page	Plain Shank	Page
②	END MILL HOLDER	D118 - 137	HYDRAULIC CHUCK POWER MILLING CHUCK	D15 - 46 D161 - 176
②	-	-	SHRINK FIT HOLDER	D47 - 72
②	-	-	ER COLLET CHUCK SK SLIM CHUCK	D73 - 116 D183 - 201

Unit : mm

EDP No.	Mill Diameter	Shank Diameter	Length of Cut	Overall Length
G9424010	1.0	4	3	40
G9424015	1.5	4	4.5	40
G9424020	2.0	2	8	32
G9424025	2.5	2.5	8	32
G9424030	3.0	3	12	32
G9424035	3.5	3.5	12	32
G9424040	4.0	4	12	40
G9424045	4.5	4.5	14	50
G9424050	5.0	5	14	50
G9424055	5.5	5.5	16	50
G9424060	6.0	6	16	50
G9424070	7.0	7	20	60
G9424080	8.0	8	20	60
G9424090	9.0	9	20	60
G9424100	10.0	10	22	70
G9424120	12.0	12	22	70
G9424140	14.0	14	25	75
G9424160	16.0	16	25	75
G9424200	20.0	20	32	100

Mill Dia. Tolerance(mm)	Shank Dia. Tolerance
0 ~ - 0.03	h5

ISO Material Description	P										M				K					
	Non-alloy steel					Low alloy steel					High alloyed steel, and tool steel		Stainless steel		Grey cast iron		Nodular cast iron		Malleable cast iron	
VDI 3323	1	2	3	4	5	6	7	8	9	10	11	12	13	14	15	16	17	18	19	20
HRc	13	25	28	32	38	10	29	32	38	45	15	23	10	10	10	26	3	25	21	21
HB	125	190	250	270	300	180	275	300	350	200	200	240	180	180	180	260	160	250	130	230
Recommend	⊙	⊙	⊙	⊙	⊙	⊙	⊙	⊙	⊙	⊙	○	○	○	○	○	○	○	○	○	○



PLAIN SHANK **G9G44** SERIES

CARBIDE, 2 FLUTE SHORT LENGTH WITH CHAMFER

- VOLLHARTMETALL, 2 SCHNEIDEN KURZ
- Fraise carbure, 2 dents, courte
- 2 TAGLIENTI, CORTA

- ▶ Suitable for dry milling applications at high temperatures.
- ▶ Excellent high-performance end mills.
- ▶ 2 flute design for slotting.

- ▶ Für die Trockenbearbeitung.
- ▶ Hervorragendes Preis - Leistungsverhältnis.
- ▶ 2 Schneiden zum Nutenfräsen.

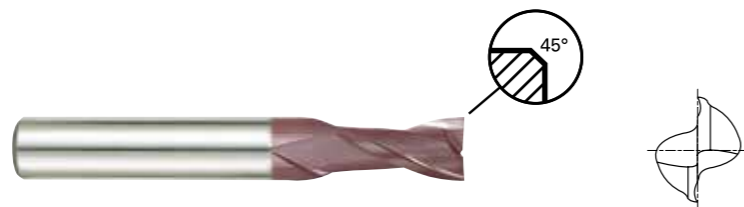

CARBIDE 2 30° DIN 6535HA C x 45° TiAIN p.C571

Flat Shank	Page	Plain Shank	Page
END MILL HOLDER	D118 - 137	HYDRAULIC CHUCK POWER MILLING CHUCK	D15 - 46 D161 - 176
-	-	SHRINK FIT HOLDER	D47 - 72
-	-	ER COLLET CHUCK SK SLIM CHUCK	D73 - 116 D183 - 201

Unit : mm

EDP No.	Mill Diameter	Shank Diameter	Length of Cut	Overall Length	Chamfer
G9G44030	3.0	3	12	32	0.10
G9G44040	4.0	4	12	40	0.10
G9G44050	5.0	5	14	50	0.10
G9G44060	6.0	6	16	50	0.10
G9G44080	8.0	8	20	60	0.13
G9G44100	10.0	10	22	70	0.13
G9G44120	12.0	12	22	70	0.18
G9G44140	14.0	14	25	75	0.18
G9G44160	16.0	16	25	75	0.18
G9G44200	20.0	20	32	100	0.23

Mill Dia. Tolerance(mm)	Shank Dia. Tolerance
0 ~ - 0.03	h5

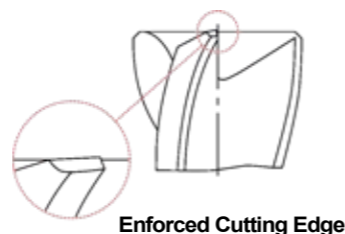

◎ : Excellent ○ : Good

ISO Material Description	P										M				K					
	Non-alloy steel					Low alloy steel					High alloyed steel, and tool steel		Stainless steel		Grey cast iron		Nodular cast iron		Malleable cast iron	
VDI 3323	1	2	3	4	5	6	7	8	9	10	11	12	13	14	15	16	17	18	19	20
HRc	13	25	28	32	38	10	29	32	38	45	15	35	15	23	10	10	26	3	25	21
HB	125	190	250	270	300	180	275	300	350	200	325	200	240	180	180	260	160	250	130	230
Recommend	◎	◎	◎	◎	◎	◎	◎	◎	◎	◎	◎	◎	◎	◎	◎	◎	◎	◎	◎	◎

ISO Material Description	N					S					H										
	Aluminum-wrought alloy		Aluminum-cast, alloyed			Copper and Copper Alloys (Bronze / Brass)		Non Metallic Materials			Heat Resistant Super Alloys					Titanium Alloys		Hardened steel	Chilled Cast Iron	Hardened Cast Iron	
VDI 3323	21	22	23	24	25	26	27	28	29	30	31	32	33	34	35	36	37	38	39	40	41
HRc	21	22	23	24	25	26	27	28	29	30	31	32	33	34	35	36	37	38	39	40	41
HB	60	100	75	90	130	110	90	100			200	280	250	350	320	400 Rm	1050 Rm	550	630	400	550
Recommend	◎	◎	◎	◎	◎	◎	◎	◎	◎	◎	◎	◎	◎	◎	◎	◎	◎	◎	◎	◎	◎



PLAIN SHANK **G9A68** SERIES

CARBIDE, 2 FLUTE SHORT LENGTH

- VOLLHARTMETALL, 2 SCHNEIDEN KURZ
- Fraise carbure, 2 dents, courte
- 2 TAGLIENTI, CORTA

- ▶ Suitable for dry milling applications at high temperatures.
- ▶ Excellent high-performance end mills.
- ▶ 2 flute design for slotting.

- ▶ Für die Trockenbearbeitung.
- ▶ Hervorragendes Preis - Leistungsverhältnis.
- ▶ 2 Schneiden zum Nutenfräsen.



CARBIDE 2 30° DIN 6535HA TiAIN p.C571

Flat Shank	Page	Plain Shank	Page
END MILL HOLDER	D118 - 137	HYDRAULIC CHUCK POWER MILLING CHUCK	D15 - 46 D161 - 176
-	-	SHRINK FIT HOLDER	D47 - 72
-	-	ER COLLET CHUCK SK SLIM CHUCK	D73 - 116 D183 - 201

Unit : mm

EDP No.	Mill Diameter	Shank Diameter	Length of Cut	Overall Length
G9A68010	1.0	3	3	39
G9A68015	1.5	3	5	39
G9A68020	2.0	3	7	39
G9A68025	2.5	3	7	39
G9A68030	3.0	3	9	39
G9A68040	4.0	4	14	51
G9A68050	5.0	5	16	51
G9A68060	6.0	6	19	64
G9A68080	8.0	8	21	64
G9A68100	10.0	10	22	70
G9A68120	12.0	12	25	76
G9A68160	16.0	16	32	89
G9A68200	20.0	20	38	102

Mill Dia. Tolerance(mm)	Shank Dia. Tolerance
0 ~ - 0.03	h5

◎ : Excellent ○ : Good

ISO Material Description	P										M				K					
	Non-alloy steel					Low alloy steel					High alloyed steel, and tool steel		Stainless steel		Grey cast iron		Nodular cast iron		Malleable cast iron	
VDI 3323	1	2	3	4	5	6	7	8	9	10	11	12	13	14	15	16	17	18	19	20
HRc	13	25	28	32	38	10	29	32	38	45	15	35	15	23	10	10	26	3	25	21
HB	125	190	250	270	300	180	275	300	350	200	325	200	240	180	180	260	160	250	130	230
Recommend	◎	◎	◎	◎	◎	◎	◎	◎	◎	◎	◎	◎	◎	◎	◎	◎	◎	◎	◎	◎

ISO Material Description	N					S					H										
	Aluminum-wrought alloy		Aluminum-cast, alloyed			Copper and Copper Alloys (Bronze / Brass)		Non Metallic Materials			Heat Resistant Super Alloys					Titanium Alloys		Hardened steel	Chilled Cast Iron	Hardened Cast Iron	
VDI 3323	21	22	23	24	25	26	27	28	29	30	31	32	33	34	35	36	37	38	39	40	41
HRc	21	22	23	24	25	26	27	28	29	30	31	32	33	34	35	36	37	38	39	40	41
HB	60	100	75	90	130	110	90	100			200	280	250	350	320	400 Rm	1050 Rm	550	630	400	550
Recommend	◎	◎	◎	◎	◎	◎	◎	◎	◎	◎	◎	◎	◎	◎	◎	◎	◎	◎	◎	◎	◎

CARBIDE, 2 FLUTE SHORT LENGTH

- VOLLHARTMETALL, 2 SCHNEIDEN KURZ
- Fraise carbure, 2 dents, courte
- 2 TAGLIENTI, CORTA

- ▶ Suitable for dry milling applications at high temperatures.
- ▶ Excellent high-performance end mills.
- ▶ 2 flute design for slotting.

- ▶ Für die Trockenbearbeitung.
- ▶ Hervorragendes Preis - Leistungsverhältnis.
- ▶ 2 Schneiden zum Nutenfräsen.

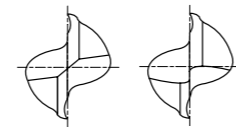

under Ø3mm from Ø3mm

CARBIDE DIN 6527 2 30° DIN 6535HB TiAlN p.C571

Flat Shank	Page	Plain Shank	Page
END MILL HOLDER	D118 - 137	HYDRAULIC CHUCK POWER MILLING CHUCK	D15 - 46 D161 - 176
-	-	SHRINK FIT HOLDER	D47 - 72
-	-	ER COLLET CHUCK SK SLIM CHUCK	D73 - 116 D183 - 201

Unit : mm

EDP No.	Mill Diameter	Shank Diameter	Length of Cut	Overall Length
G9444020	2.0	6	3	50
G9444030	3.0	6	4	50
G9444035	3.5	6	4	50
G9444040	4.0	6	5	54
G9444045	4.5	6	5	54
G9444050	5.0	6	6	54
G9444060	6.0	6	7	54
G9444070	7.0	8	8	58
G9444080	8.0	8	9	58
G9444090	9.0	10	10	66
G9444100	10.0	10	11	66
G9444120	12.0	12	12	73
G9444140	14.0	14	14	75
G9444160	16.0	16	16	82
G9444180	18.0	18	18	84
G9444200	20.0	20	20	92

Mill Dia. Tolerance(mm)	Shank Dia. Tolerance
0 ~ - 0.03	h5

◎ : Excellent ○ : Good

ISO Material Description	P										M				K						
	Non-alloy steel					Low alloy steel					High alloyed steel, and tool steel				Stainless steel		Grey cast iron	Nodular cast iron		Malleable cast iron	
VDI 3323	1	2	3	4	5	6	7	8	9	10	11	12	13	14	15	16	17	18	19	20	
HRc	13	25	28	32	38	10	29	32	38	15	35	15	23	10	10	26	3	25	21		
HB	125	190	250	270	300	180	275	300	350	200	325	200	240	180	180	260	160	250	130	230	
Recommend	◎	◎	◎	◎	◎	◎	◎	◎	◎	◎	◎	◎	◎	◎	◎	◎	◎	◎	◎	◎	◎

ISO Material Description	N					S					H											
	Aluminum-wrought alloy		Aluminum-cast, alloyed			Copper and Copper Alloys (Bronze / Brass)			Non Metallic Materials		Heat Resistant Super Alloys					Titanium Alloys		Hardened steel	Chilled Cast Iron	Hardened Cast Iron		
VDI 3323	21	22	23	24	25	26	27	28	29	30	31	32	33	34	35	36	37	38	39	40	41	
HRc	21	22	23	24	25	26	27	28	29	30	31	32	33	34	35	36	37	38	39	40	41	
HB	60	100	75	90	130	110	90	100			200	280	250	350	320	400 Rm	1050 Rm	550	630	400	550	
Recommend	◎	◎	◎	◎	◎	◎	◎	◎	◎	◎	◎	◎	◎	◎	◎	◎	◎	◎	◎	◎	◎	◎

CARBIDE, 2 FLUTE LONG LENGTH

- VOLLHARTMETALL, 2 SCHNEIDEN LANG
- Fraise carbure, 2 dents, longue
- 2 TAGLIENTI, SERIE LUNGA

- ▶ Suitable for dry milling applications at high temperatures.
- ▶ Excellent high-performance end mills.
- ▶ 2 flute design for slotting.

- ▶ Für die Trockenbearbeitung.
- ▶ Hervorragendes Preis - Leistungsverhältnis.
- ▶ 2 Schneiden zum Nutenfräsen.

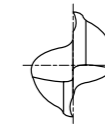

CARBIDE DIN 6528 2 30° DIN 6535HA TiAlN p.C571

Flat Shank	Page	Plain Shank	Page
END MILL HOLDER	D118 - 137	HYDRAULIC CHUCK POWER MILLING CHUCK	D15 - 46 D161 - 176
-	-	SHRINK FIT HOLDER	D47 - 72
-	-	ER COLLET CHUCK SK SLIM CHUCK	D73 - 116 D183 - 201

Unit : mm

EDP No.	Mill Diameter	Shank Diameter	Length of Cut	Overall Length
G9527035	3.5	3.5	7	50
G9527040	4.0	4	8	50
G9527045	4.5	4.5	8	50
G9527050	5.0	5	10	50
G9527055	5.5	5.5	10	57
G9527060	6.0	6	10	57
G9527065	6.5	6.5	13	60
G9527070	7.0	7	13	60
G9527075	7.5	7.5	16	63
G9527080	8.0	8	16	63
G9527085	8.5	8.5	16	67
G9527090	9.0	9	16	67
G9527095	9.5	9.5	19	72
G9527100	10.0	10	19	72
G9527110	11.0	11	22	83
G9527120	12.0	12	22	83
G9527130	13.0	13	22	83
G9527140	14.0	14	22	83
G9527150	15.0	15	26	92
G9527160	16.0	16	26	92
G9527180	18.0	18	26	92
G9527200	20.0	20	32	104

Mill Dia. Tolerance(mm)	Shank Dia. Tolerance
0 ~ - 0.03	h5

◎ : Excellent ○ : Good

ISO Material Description	P										M				K						
	Non-alloy steel					Low alloy steel					High alloyed steel, and tool steel				Stainless steel		Grey cast iron	Nodular cast iron		Malleable cast iron	
VDI 3323	1	2	3	4	5	6	7	8	9	10	11	12	13	14	15	16	17	18	19	20	
HRc	13	25	28	32	38	10	29	32	38	15	35	15	23	10	10	26	3	25	21		
HB	125	190	250	270	300	180	275	300	350	200	325	200	240	180	180	260	160	250	130	230	
Recommend	◎	◎	◎	◎	◎	◎	◎	◎	◎	◎	◎	◎	◎	◎	◎	◎	◎	◎	◎	◎	◎

ISO Material Description	N					S					H											
	Aluminum-wrought alloy		Aluminum-cast, alloyed			Copper and Copper Alloys (Bronze / Brass)			Non Metallic Materials		Heat Resistant Super Alloys					Titanium Alloys		Hardened steel	Chilled Cast Iron	Hardened Cast Iron		
VDI 3323	21	22	23	24	25	26	27	28	29	30	31	32	33	34	35	36	37	38	39	40	41	
HRc	21	22	23	24	25	26	27	28	29	30	31	32	33	34	35	36	37	38	39	40	41	
HB	60	100	75	90	130	110	90	100			200	280	250	350	320	400 Rm	1050 Rm	550	630	400	550	
Recommend	◎	◎	◎	◎	◎	◎	◎	◎	◎	◎	◎	◎	◎	◎	◎	◎	◎	◎	◎	◎	◎	◎



FLAT SHANK **G9445** SERIES

CARBIDE, 2 FLUTE LONG LENGTH

● **VOLLHARTMETALL, 2 SCHNEIDEN LANG**
 (●) **Fraise carbure, 2 dents, longue**
 (●) **2 TAGLIENTI, SERIE LUNGA**

- ▶ Suitable for dry milling applications at high temperatures.
- ▶ Excellent high-performance end mills.
- ▶ 2 flute design for slotting.

- ▶ Für die Trockenbearbeitung.
- ▶ Hervorragendes Preis - Leistungsverhältnis.
- ▶ 2 Schneiden zum Nutenfräsen.

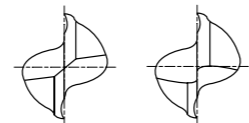

up to Ø2mm over Ø2mm



Recommended ToolHolder	Flat Shank		Plain Shank	
	Page	Page	Page	Page
END MILL HOLDER	D118 - 137	HYDRAULIC CHUCK POWER MILLING CHUCK	D15 - 46	D161 - 176
	-	SHRINK FIT HOLDER	D47 - 72	
	-	ER COLLET CHUCK SK SLIM CHUCK	D73 - 116	D183 - 201

Unit : mm

EDP No.	Mill Diameter	Shank Diameter	Length of Cut	Overall Length
G9445901	2.0	● 3	6	38
G9445028	2.8	6	7	57
G9445030	3.0	6	7	57
G9445035	3.5	6	7	57
G9445038	3.8	6	8	57
G9445040	4.0	6	8	57
G9445045	4.5	6	8	57
G9445048	4.8	6	10	57
G9445050	5.0	6	10	57
G9445957	5.8	6	10	57
G9445060	6.0	6	10	57
G9445967	6.8	8	13	63
G9445070	7.0	8	13	63
G9445977	7.8	8	16	63
G9445080	8.0	8	16	63
G9445087	8.7	10	16	72
G9445090	9.0	10	16	72
G9445097	9.7	10	19	72
G9445100	10.0	10	19	72
G9445117	11.7	12	22	83
G9445120	12.0	12	22	83
G9445137	13.7	14	22	83
G9445140	14.0	14	22	83

● with plain shank

▶ NEXT PAGE

Mill Dia. Tolerance(mm)	Shank Dia. Tolerance
0 ~ - 0.03	h5

◎ : Excellent ○ : Good

ISO Material Description	P										M				K					
	Non-alloy steel					Low alloy steel					High alloyed steel, and tool steel		Stainless steel		Grey cast iron		Nodular cast iron		Malleable cast iron	
VDI 3323	1	2	3	4	5	6	7	8	9	10	11	12	13	14	15	16	17	18	19	20
HRc	13	25	28	32	38	10	29	32	38	45	15	35	40	45	10	26	3	25	21	21
HB	125	190	250	270	300	180	275	300	350	400	200	325	200	240	180	260	160	250	130	230
Recommend	◎	◎	◎	◎	◎	◎	◎	◎	◎	◎	◎	◎	◎	◎	◎	◎	◎	◎	◎	◎



FLAT SHANK **G9445** SERIES

CARBIDE, 2 FLUTE LONG LENGTH

● **VOLLHARTMETALL, 2 SCHNEIDEN LANG**
 (●) **Fraise carbure, 2 dents, longue**
 (●) **2 TAGLIENTI, SERIE LUNGA**

- ▶ Suitable for dry milling applications at high temperatures.
- ▶ Excellent high-performance end mills.
- ▶ 2 flute design for slotting.

- ▶ Für die Trockenbearbeitung.
- ▶ Hervorragendes Preis - Leistungsverhältnis.
- ▶ 2 Schneiden zum Nutenfräsen.

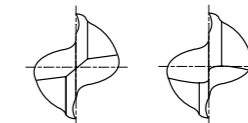

up to Ø2mm over Ø2mm



Recommended ToolHolder	Flat Shank		Plain Shank	
	Page	Page	Page	Page
END MILL HOLDER	D118 - 137	HYDRAULIC CHUCK POWER MILLING CHUCK	D15 - 46	D161 - 176
	-	SHRINK FIT HOLDER	D47 - 72	
	-	ER COLLET CHUCK SK SLIM CHUCK	D73 - 116	D183 - 201

Unit : mm

EDP No.	Mill Diameter	Shank Diameter	Length of Cut	Overall Length
G9445157	15.7	16	26	92
G9445160	16.0	16	26	92
G9445177	17.7	18	26	92
G9445180	18.0	18	26	92
G9445197	19.7	20	32	104
G9445200	20.0	20	32	104

Mill Dia. Tolerance(mm)	Shank Dia. Tolerance
0 ~ - 0.03	h5

◎ : Excellent ○ : Good

ISO Material Description	P										M				K					
	Non-alloy steel					Low alloy steel					High alloyed steel, and tool steel		Stainless steel		Grey cast iron		Nodular cast iron		Malleable cast iron	
VDI 3323	1	2	3	4	5	6	7	8	9	10	11	12	13	14	15	16	17	18	19	20
HRc	13	25	28	32	38	10	29	32	38	45	15	35	40	45	10	26	3	25	21	21
HB	125	190	250	270	300	180	275	300	350	400	200	325	200	240	180	260	160	250	130	230
Recommend	◎	◎	◎	◎	◎	◎	◎	◎	◎	◎	◎	◎	◎	◎	◎	◎	◎	◎	◎	◎



FLAT SHANK **G9G45** SERIES

CARBIDE, 2 FLUTE LONG LENGTH WITH CHAMFER

● **VOLLHARTMETALL, 2 SCHNEIDEN LANG**
 (●) **Fraise carbure, 2 dents, longue**
 (●) **2 TAGLIENTI, SERIE LUNGA**

- ▶ Suitable for dry milling applications at high temperatures.
- ▶ Excellent high-performance end mills.
- ▶ 2 flute design for slotting.

- ▶ Für die Trockenbearbeitung.
- ▶ Hervorragendes Preis - Leistungsverhältnis.
- ▶ 2 Schneiden zum Nutenfräsen.

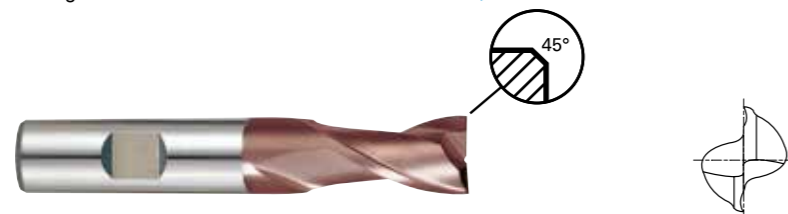

Recommended ToolHolder	Flat Shank		Plain Shank	
	Page	Page	Page	Page
END MILL HOLDER	D118 - 137	HYDRAULIC CHUCK POWER MILLING CHUCK	D15 - 46 D161 - 176	
	-	SHRINK FIT HOLDER	D47 - 72	
	-	ER COLLET CHUCK SK SLIM CHUCK	D73 - 116 D183 - 201	

Unit : mm

EDP No.	Mill Diameter	Shank Diameter	Length of Cut	Overall Length	Chamfer
G9G45030	3.0	6	7	57	0.10
G9G45040	4.0	6	8	57	0.10
G9G45050	5.0	6	10	57	0.10
G9G45060	6.0	6	10	57	0.10
G9G45080	8.0	8	16	63	0.13
G9G45100	10.0	10	19	72	0.13
G9G45120	12.0	12	22	83	0.18
G9G45140	14.0	14	22	83	0.18
G9G45160	16.0	16	26	92	0.18
G9G45200	20.0	20	32	104	0.23

Mill Dia. Tolerance(mm)	Shank Dia. Tolerance
0 ~ - 0.03	h5

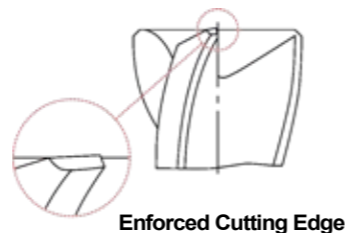

◎ : Excellent ○ : Good

ISO Material Description	P										M				K					
	Non-alloy steel					Low alloy steel					High alloyed steel, and tool steel		Stainless steel		Grey cast iron		Nodular cast iron		Malleable cast iron	
VDI 3323	1	2	3	4	5	6	7	8	9	10	11	12	13	14	15	16	17	18	19	20
HRc	13	25	28	32	38	10	29	32	38	45	15	35	40	45	15	26	3	25	21	21
HB	125	190	250	270	300	180	275	300	350	200	325	200	240	180	180	260	160	250	130	230
Recommend	◎	◎	◎	◎	◎	◎	◎	◎	◎	◎	◎	◎	◎	◎	◎	◎	◎	◎	◎	◎

ISO Material Description	N										S						H				
	Aluminum-wrought alloy		Aluminum-cast, alloyed			Copper and Copper Alloys (Bronze / Brass)					Non Metallic Materials		Heat Resistant Super Alloys				Titanium Alloys		Hardened steel	Chilled Cast Iron	Hardened Cast Iron
VDI 3323	21	22	23	24	25	26	27	28	29	30	31	32	33	34	35	36	37	38	39	40	41
HRc	21	22	23	24	25	26	27	28	29	30	31	32	33	34	35	36	37	38	39	40	41
HB	60	100	75	90	130	110	90	100			200	280	250	350	320	400 Rm	1050 Rm	550	630	400	550
Recommend	◎	◎	◎	◎	◎	◎	◎	◎	◎	◎	◎	◎	◎	◎	◎	◎	◎	◎	◎	◎	◎



PLAIN SHANK **G9452** SERIES

CARBIDE, 2 FLUTE EXTRA LONG LENGTH

● **VOLLHARTMETALL, 2 SCHNEIDEN EXTRA LANG**
 (●) **Fraise carbure, 2 dents, extra-longue**
 (●) **2 TAGLIENTI, SERIE EXTRA LUNGA**

- ▶ Suitable for dry milling applications at high temperatures.
- ▶ Excellent high-performance end mills.
- ▶ 2 flute design for slotting.

- ▶ Für die Trockenbearbeitung.
- ▶ Hervorragendes Preis - Leistungsverhältnis.
- ▶ 2 Schneiden zum Nutenfräsen.



Recommended ToolHolder	Flat Shank		Plain Shank	
	Page	Page	Page	Page
END MILL HOLDER	D118 - 137	HYDRAULIC CHUCK POWER MILLING CHUCK	D15 - 46 D161 - 176	
	-	SHRINK FIT HOLDER	D47 - 72	
	-	ER COLLET CHUCK SK SLIM CHUCK	D73 - 116 D183 - 201	

Unit : mm

EDP No.	Mill Diameter	Shank Diameter	Length of Cut	Overall Length
G9452903	3.0	3	20	60
G9452030	3.0	3	30	75
G9452904	4.0	4	20	60
G9452040	4.0	4	30	75
G9452905	5.0	5	25	75
G9452050	5.0	5	40	100
G9452906	6.0	6	30	75
G9452060	6.0	6	50	150
G9452908	8.0	8	30	75
G9452080	8.0	8	50	150
G9452910	10.0	10	40	100
G9452100	10.0	10	60	150
G9452912	12.0	12	45	100
G9452120	12.0	12	75	150
G9452914	14.0	14	45	100
G9452140	14.0	14	65	150
G9452916	16.0	16	45	100
G9452160	16.0	16	65	150
G9452918	18.0	18	45	100
G9452180	18.0	18	65	150
G9452920	20.0	20	45	100
G9452200	20.0	20	65	150

Mill Dia. Tolerance(mm)	Shank Dia. Tolerance
0 ~ - 0.03	h5

◎ : Excellent ○ : Good

ISO Material Description	P										M				K					
	Non-alloy steel					Low alloy steel					High alloyed steel, and tool steel		Stainless steel		Grey cast iron		Nodular cast iron		Malleable cast iron	
VDI 3323	1	2	3	4	5	6	7	8	9	10	11	12	13	14	15	16	17	18	19	20
HRc	13	25	28	32	38	10	29	32	38	45	15	35	40	45	15	26	3	25	21	21
HB	125	190	250	270	300	180	275	300	350	200	325	200	240	180	180	260	160	250	130	230
Recommend	◎	◎	◎	◎	◎	◎	◎	◎	◎	◎	◎	◎	◎	◎	◎	◎	◎	◎	◎	◎

ISO Material Description	N										S						H				
	Aluminum-wrought alloy		Aluminum-cast, alloyed			Copper and Copper Alloys (Bronze / Brass)					Non Metallic Materials		Heat Resistant Super Alloys				Titanium Alloys		Hardened steel	Chilled Cast Iron	Hardened Cast Iron
VDI 3323	21	22	23	24	25	26	27	28	29	30	31	32	33	34	35	36	37	38	39	40	41
HRc	21	22	23	24	25	26	27	28	29	30	31	32	33	34	35	36	37	38	39	40	41
HB	60	100	75	90	130	110	90	100			200	280	250	350	320	400 Rm	1050 Rm	550	630	400	550
Recommend	◎	◎	◎	◎	◎	◎	◎	◎	◎	◎	◎	◎	◎	◎	◎	◎	◎	◎	◎	◎	◎

CARBIDE, 2 FLUTE RIB PROCESSING

● VOLLHARTMETALL, 2 SCHNEIDEN SCHMALE RIPPEN

① Fraise carbure, 2 dents pour usinage de rainure
② 2 TAGLIANTI, SCARICATA PER NERVATURE

- Suitable for dry milling applications at high temperatures.
- Excellent high-performance end mills.
- 2 flute design for slotting.

- Für die Trockenbearbeitung.
- Hervorragendes Preis - Leistungsverhältnis.
- 2 Schneiden zum Nutenfräsen.

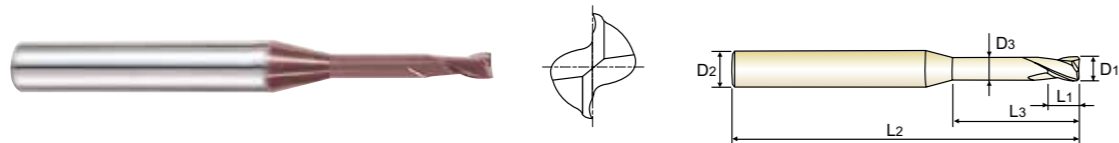

Recommended ToolHolder	Flat Shank	Page	Plain Shank	Page
①	END MILL HOLDER	D118-137	HYDRAULIC CHUCK POWER MILLING CHUCK	D15-46 D161-176
②	-	-	SHRINK FIT HOLDER	D47-72
③	-	-	ER COLLET CHUCK SK SLIM CHUCK	D73-116 D183-201

Unit : mm

EDP No.	Mill Diameter	Shank Diameter	Length of Cut	Length Below Shank	Overall Length	Neck Diameter
	D1	D2	L1	L3	D3	D3
G9B80004	0.4	4	0.7	2	50	0.37
G9B80901	0.4	4	0.7	4	50	0.37
G9B80005	0.5	4	0.75	2	50	0.45
G9B80902	0.5	4	0.75	4	50	0.45
G9B80903	0.5	4	0.75	6	50	0.45
G9B80006	0.6	4	0.9	2	50	0.55
G9B80904	0.6	4	0.9	4	50	0.55
G9B80905	0.6	4	0.9	6	50	0.55
G9B80007	0.7	4	1.1	4	50	0.65
G9B80906	0.7	4	1.1	6	50	0.65
G9B80008	0.8	4	1.2	4	50	0.75
G9B80907	0.8	4	1.2	6	50	0.75
G9B80908	0.8	4	1.2	8	50	0.75
G9B80009	0.9	4	1.4	6	50	0.85
G9B80909	0.9	4	1.4	8	50	0.85
G9B80910	0.9	4	1.4	10	50	0.85
G9B80010	1.0	4	1.5	6	50	0.95
G9B80911	1.0	4	1.5	8	50	0.95
G9B80912	1.0	4	1.5	10	50	0.95
G9B80913	1.0	4	1.5	12	50	0.95
G9B80012	1.2	4	1.8	6	50	1.15
G9B80914	1.2	4	1.8	8	50	1.15
G9B80915	1.2	4	1.8	10	50	1.15
G9B80916	1.2	4	1.8	12	50	1.15

► NEXT PAGE

Mill Dia. Tolerance(mm)	Shank Dia. Tolerance
0 ~ -0.03	h5

◎ : Excellent ○ : Good

ISO	P						M						K							
Material Description	Non-alloy steel				Low alloy steel		High alloyed steel, and tool steel		Stainless steel		Grey cast iron		Nodular cast iron		Malleable cast iron					
VDI 3323	1	2	3	4	5	6	7	8	9	10	11	12	13	14	15	16	17	18	19	20
HRc	13	25	28	32	10	29	32	38	15	35	15	23	10	10	26	3	25	21	21	
HB	125	190	250	270	300	180	275	300	350	200	325	200	240	180	180	260	160	250	130	230
Recommend	◎	◎	◎	◎	◎	◎	◎	◎	◎	◎	◎	◎	◎	◎	◎	◎	◎	◎	◎	◎

ISO	N						S						H								
Material Description	Aluminum-wrought alloy		Aluminum-cast, alloyed		Copper and Copper Alloys (Bronze / Brass)		Non Metallic Materials		Heat Resistant Super Alloys			Titanium Alloys			Hardened steel	Chilled Cast Iron		Hardened Cast Iron			
VDI 3323	21	22	23	24	25	26	27	28	29	30	31	32	33	34	35	36	37	38	39	40	41
HRc	15	30	25	38	34	15	30	25	38	34	55	60	42	55	55	60	42	55	55	55	
HB	60	100	75	90	130	110	90	100			200	280	250	350	320	400 Rm	1050 Rm	550	630	400	550
Recommend	○	○	○	○	○	○	○	○													

CARBIDE, 2 FLUTE RIB PROCESSING

● VOLLHARTMETALL, 2 SCHNEIDEN SCHMALE RIPPEN

① Fraise carbure, 2 dents pour usinage de rainure
② 2 TAGLIANTI, SCARICATA PER NERVATURE

- Suitable for dry milling applications at high temperatures.
- Excellent high-performance end mills.
- 2 flute design for slotting.

- Für die Trockenbearbeitung.
- Hervorragendes Preis - Leistungsverhältnis.
- 2 Schneiden zum Nutenfräsen.

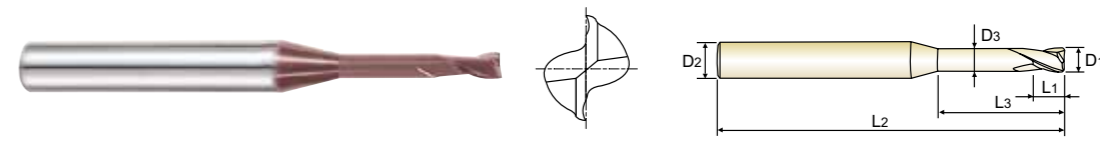

Recommended ToolHolder	Flat Shank	Page	Plain Shank	Page
①	END MILL HOLDER	D118-137	HYDRAULIC CHUCK POWER MILLING CHUCK	D15-46 D161-176
②	-	-	SHRINK FIT HOLDER	D47-72
③	-	-	ER COLLET CHUCK SK SLIM CHUCK	D73-116 D183-201

Unit : mm

EDP No.	Mill Diameter	Shank Diameter	Length of Cut	Length Below Shank	Overall Length	Neck Diameter
	D1	D2	L1	L3	D3	D3
G9B80015	1.5	4	2.3	6	50	1.45
G9B80917	1.5	4	2.3	8	50	1.45
G9B80918	1.5	4	2.3	10	50	1.45
G9B80919	1.5	4	2.3	12	50	1.45
G9B80920	1.5	4	2.3	14	50	1.45
G9B80921	1.5	4	2.3	16	50	1.45
G9B80922	1.5	4	2.3	18	50	1.45
G9B80923	1.5	4	2.3	20	50	1.45
G9B80020	2.0	4	3	6	50	1.95
G9B80924	2.0	4	3	8	50	1.95
G9B80925	2.0	4	3	10	50	1.95
G9B80926	2.0	4	3	12	50	1.95
G9B80927	2.0	4	3	14	50	1.95
G9B80928	2.0	4	3	16	50	1.95
G9B80929	2.0	4	3	18	50	1.95
G9B80930	2.0	4	3	20	50	1.95
G9B80025	2.5	4	3.7	8	50	2.40
G9B80931	2.5	4	3.7	12	50	2.40
G9B80932	2.5	4	3.7	16	50	2.40
G9B80933	2.5	4	3.7	20	50	2.40

► NEXT PAGE

Mill Dia. Tolerance(mm)	Shank Dia. Tolerance
0 ~ -0.03	h5

◎ : Excellent ○ : Good

ISO	P						M						K							
Material Description	Non-alloy steel				Low alloy steel		High alloyed steel, and tool steel		Stainless steel		Grey cast iron		Nodular cast iron		Malleable cast iron					
VDI 3323	1	2	3	4	5	6	7	8	9	10	11	12	13	14	15	16	17	18	19	20
HRc	13	25	28	32	10	29	32	38	15	35	15	23	10	10	26	3	25	21	21	
HB	125	190	250	270	300	180	275	300	350	200	325	200	240	180	180	260	160	250	130	230
Recommend	◎	◎	◎	◎	◎	◎	◎	◎	◎	◎	◎	◎	◎	◎	◎	◎	◎	◎	◎	◎

ISO	N						S						H								
Material Description	Aluminum-wrought alloy		Aluminum-cast, alloyed		Copper and Copper Alloys (Bronze / Brass)		Non Metallic Materials		Heat Resistant Super Alloys			Titanium Alloys			Hardened steel	Chilled Cast Iron		Hardened Cast Iron			
VDI 3323	21	22	23	24	25	26	27	28	29	30	31	32	33	34	35	36	37	38	39	40	41
HRc	15	30	25	38	34	15	30	25	38	34	55	60	42	55	55	60	42	55	55	55	
HB	60	100	75	90	130	110	90	100			200	280	250	350	320	400 Rm	1050 Rm	550	630	400	550
Recommend	○	○	○	○	○	○	○	○													



PLAIN SHANK **G9B80** SERIES

CARBIDE, 2 FLUTE RIB PROCESSING

- VOLLHARTMETALL, 2 SCHNEIDEN SCHMALE RIPPEN
- ① Fraise carbure, 2 dents pour usinage de rainure
- ② 2 TAGLIENTI, SCARICATA PER NERVATURE

- Suitable for dry milling applications at high temperatures.
- Excellent high-performance end mills.
- 2 flute design for slotting.

- Für die Trockenbearbeitung.
- Hervorragendes Preis - Leistungsverhältnis.
- 2 Schneiden zum Nutenfräsen.

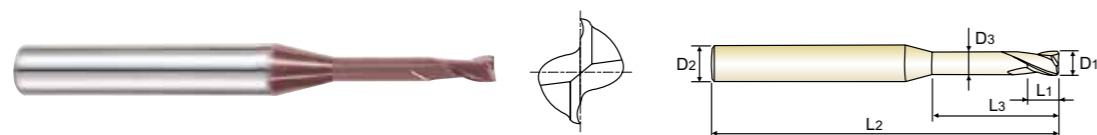

CARBIDE 2 30° DIN 6535HA TiAIN p.C572-573

Flat Shank	Page	Plain Shank	Page
END MILL HOLDER	D118 - 137	HYDRAULIC CHUCK POWER MILLING CHUCK	D15 - 46 D161 - 176
-	-	SHRINK FIT HOLDER	D47 - 72
-	-	ER COLLET CHUCK SK SLIM CHUCK	D73 - 116 D183 - 201

Unit : mm

EDP No.	Mill Diameter	Shank Diameter	Length of Cut	Length Below Shank	Overall Length	Neck Diameter
	D1	D2	L1	L3	D3	D3
G9B80030	3.0	6	4.5	8	50	2.85
G9B80934	3.0	6	4.5	12	50	2.85
G9B80935	3.0	6	4.5	16	60	2.85
G9B80936	3.0	6	4.5	20	60	2.85
G9B80937	3.0	6	4.5	25	75	2.85
G9B80040	4.0	6	6	12	50	3.85
G9B80938	4.0	6	6	16	60	3.85
G9B80939	4.0	6	6	20	75	3.85
G9B80940	4.0	6	6	25	75	3.85
G9B80941	4.0	6	6	30	75	3.85
G9B80942	4.0	6	6	35	75	3.85

Mill Dia. Tolerance(mm)	Shank Dia. Tolerance
0 ~ - 0.03	h5

◎ : Excellent ○ : Good

ISO Material Description	P										M				K						
	Non-alloy steel					Low alloy steel					High alloyed steel, and tool steel				Stainless steel		Grey cast iron		Nodular cast iron		Malleable cast iron
VDI 3323	1	2	3	4	5	6	7	8	9	10	11	12	13	14	15	16	17	18	19	20	
HRc	13	25	28	32	38	10	29	32	38	15	35	15	23	10	10	26	3	25	21	21	
HB	125	190	250	270	300	180	275	300	350	200	325	200	240	180	180	260	160	250	130	230	
Recommend	◎	◎	◎	◎	◎	◎	◎	◎	◎	◎	◎	○	○	○	○	○	○	○	○	○	○

ISO Material Description	N					S					H											
	Aluminum-wrought alloy		Aluminum-cast, alloyed			Copper and Copper Alloys (Bronze / Brass)			Non Metallic Materials		Heat Resistant Super Alloys					Titanium Alloys		Hardened steel	Chilled Cast Iron	Hardened Cast Iron		
VDI 3323	21	22	23	24	25	26	27	28	29	30	31	32	33	34	35	36	37	38	39	40	41	
HRc	15	30	25	38	34						15	30	25	38	34			55	60	42	55	
HB	60	100	75	90	130	110	90	100			200	280	250	350	320	400 Rm	1050 Rm	550	630	400	550	
Recommend	○	○	○	○	○	○	○	○	○	○	○	○	○	○	○	○	○	○	○	○	○	○



FLAT SHANK **G9410** SERIES
PLAIN SHANK **G9553** SERIES

CARBIDE, 3 FLUTE SHORT LENGTH THROW AWAY

- VOLLHARTMETALL, 3 SCHNEIDEN KURZ EINWEGFRÄSER
- ① Fraise carbure, 3 dents, à jeter, courte
- ② 3 TAGLIENTI, SERIE EXTRA CORTA

- Suitable for dry milling applications at high temperatures.
- Excellent high-performance end mills.
- 3 flute design possesses the advantage of 2 flute and 4 flute end mill.

- Für die Trockenbearbeitung.
- Hervorragendes Preis - Leistungsverhältnis.
- 3 Schneiden verbinden die Vorteile von 2 - und 4 - schneidigen Schaffräsern.



CARBIDE 3 30° PLAIN FLAT TiAIN p.C574-575

Flat Shank	Page	Plain Shank	Page
END MILL HOLDER	D118 - 137	HYDRAULIC CHUCK POWER MILLING CHUCK	D15 - 46 D161 - 176
-	-	SHRINK FIT HOLDER	D47 - 72
-	-	ER COLLET CHUCK SK SLIM CHUCK	D73 - 116 D183 - 201

Unit : mm

EDP No.	Mill Diameter	Shank Diameter	Length of Cut	Overall Length
G9553005	0.5	3	1.5	38
G9553006	0.6	3	1.5	38
G9553008	0.8	3	2	38
G9553010	1.0	3	2	38
G9553012	1.2	3	2	38
G9553015	1.5	3	2	38
G9553018	1.8	3	2	38
-	G9410020	2.0	6	35
-	G9410025	2.5	6	36
-	G9410030	3.0	6	36
-	G9410035	3.5	6	37
-	G9410040	4.0	6	38
-	G9410045	4.5	6	38
-	G9410050	5.0	6	39
-	G9410055	5.5	6	39
-	G9410957	5.8	6	39
-	G9410060	6.0	6	39
-	G9410967	6.8	8	42
-	G9410070	7.0	8	42
-	G9410977	7.8	8	42
-	G9410080	8.0	8	43
-	G9410087	8.7	10	48
-	G9410090	9.0	10	48
-	G9410097	9.7	10	48

Mill Dia. Tolerance(mm)	Shank Dia. Tolerance
0 ~ - 0.03	h5

◎ : Excellent ○ : Good

ISO Material Description	P										M				K						
	Non-alloy steel					Low alloy steel					High alloyed steel, and tool steel				Stainless steel		Grey cast iron		Nodular cast iron		Malleable cast iron
VDI 3323	1	2	3	4	5	6	7	8	9	10	11	12	13	14	15	16	17	18	19	20	
HRc	13	25	28	32	38	10	29	32	38	15	35	15	23	10	10	26	3	25	21	21	
HB	125	190	250	270	300	180	275	300	350	200	325	200	240	180	180	260	160	250	130	230	
Recommend	◎	◎	◎	◎	◎	◎	◎	◎	◎	◎	◎	○	○	○	○	○	○	○	○	○	○

ISO Material Description	N					S					H											
	Aluminum-wrought alloy		Aluminum-cast, alloyed			Copper and Copper Alloys (Bronze / Brass)			Non Metallic Materials		Heat Resistant Super Alloys					Titanium Alloys		Hardened steel	Chilled Cast Iron	Hardened Cast Iron		
VDI 3323	21	22	23	24	25	26	27	28	29	30	31	32	33	34	35	36	37	38	39	40	41	
HRc	15	30	25	38	34						15	30	25	38	34			55	60	42	55	
HB	60	100	75	90	130	110	90	100			200	280	250	350	320	400 Rm	1050 Rm	550	630	400	550	
Recommend	○	○	○	○	○	○	○	○	○	○	○	○	○	○	○	○	○	○	○	○	○	○



FLAT SHANK **G9410** SERIES

PLAIN SHANK **G9553** SERIES

CARBIDE, 3 FLUTE SHORT LENGTH THROW AWAY

● VOLLHARTMETALL, 3 SCHNEIDEN KURZ EINWEGFRÄSER

- Fraise carbure, 3 dents, à jeter, courte
- 3 TAGLIENTI, SERIE EXTRA CORTA

- Suitable for dry milling applications at high temperatures.
- Excellent high-performance end mills.
- 3 flute design possesses the advantage of 2 flute and 4 flute end mill.

- Für die Trockenbearbeitung.
- Hervorragendes Preis - Leistungsverhältnis.
- 3 Schneiden verbinden die Vorteile von 2 - und 4 - schneidigen Schaftfräsern.



p.C574-575

Flat Shank	Page	Plain Shank	Page
END MILL HOLDER	D118 - 137	HYDRAULIC CHUCK POWER MILLING CHUCK	D15 - 46 D161 - 176
-	-	SHRINK FIT HOLDER	D47 - 72
-	-	ER COLLET CHUCK SK SLIM CHUCK	D73 - 116 D183 - 201

Unit : mm

EDP No.	Mill Diameter	Shank Diameter	Length of Cut	Overall Length	
					PLAIN
-	G9410100	10.0	10	13	50
-	G9410120	12.0	12	15	55
-	G9410140	14.0	14	15	58
-	G9410160	16.0	16	18	62
-	G9410180	18.0	18	20	70
-	G9410200	20.0	20	22	75

Mill Dia. Tolerance(mm)	Shank Dia. Tolerance
0 ~ -0.03	h5

◎ : Excellent ○ : Good

ISO Material Description	P					M				K										
	Non-alloy steel					Low alloy steel				High alloyed steel, and tool steel		Stainless steel		Grey cast iron	Nodular cast iron		Malleable cast iron			
VDI 3323	1	2	3	4	5	6	7	8	9	10	11	12	13	14	15	16	17	18	19	20
HRc	13	25	28	32	38	10	29	32	38	15	35	15	23	10	10	26	3	25	21	21
HB	125	190	250	270	300	180	275	300	350	200	325	200	240	180	180	260	160	250	130	230
Recommend	◎	◎	◎	◎	◎	◎	◎	◎	◎	◎	○	○	○	○	○	○	○	○	○	○

ISO Material Description	N				S					H											
	Aluminum-wrought alloy		Aluminum-cast, alloyed		Copper and Copper Alloys (Bronze / Brass)			Non Metallic Materials		Heat Resistant Super Alloys			Titanium Alloys	Hardened steel	Chilled Cast Iron	Hardened Cast Iron					
VDI 3323	21	22	23	24	25	26	27	28	29	30	31	32	33	34	35	36	37	38	39	40	41
HRc	21	22	23	24	25	26	27	28	29	30	31	32	33	34	35	36	37	38	39	40	41
HB	60	100	75	90	130	110	90	100			200	280	250	350	320	400 Rm	1050 Rm	550	630	400	550
Recommend	○	○	○	○	○	○	○	○	○	○	○	○	○	○	○	○	○	○	○	○	○



FLAT SHANK **G9G46** SERIES

CARBIDE, 3 FLUTE SHORT LENGTH THROW AWAY WITH CHAMFER

● VOLLHARTMETALL, 3 SCHNEIDEN KURZ EINWEGFRÄSER

- Fraise carbure, 3 dents, à jeter, courte
- 3 TAGLIENTI, SERIE EXTRA CORTA

- Suitable for dry milling applications at high temperatures.
- Excellent high-performance end mills.
- 3 flute design possesses the advantage of 2 flute and 4 flute end mill.

- Für die Trockenbearbeitung.
- Hervorragendes Preis - Leistungsverhältnis.
- 3 Schneiden verbinden die Vorteile von 2 - und 4 - schneidigen Schaftfräsern.

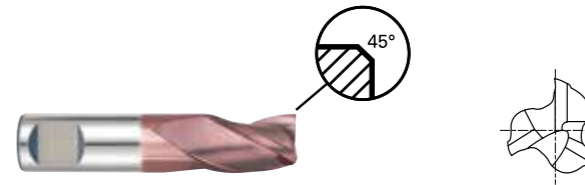

p.C574-575

Flat Shank	Page	Plain Shank	Page
END MILL HOLDER	D118 - 137	HYDRAULIC CHUCK POWER MILLING CHUCK	D15 - 46 D161 - 176
-	-	SHRINK FIT HOLDER	D47 - 72
-	-	ER COLLET CHUCK SK SLIM CHUCK	D73 - 116 D183 - 201

Unit : mm

EDP No.	Mill Diameter	Shank Diameter	Length of Cut	Overall Length	Chamfer
G9G46040	4.0	6	7	38	0.1
G9G46050	5.0	6	8	39	0.1
G9G46060	6.0	6	8	39	0.1
G9G46080	8.0	8	11	43	0.13
G9G46100	10.0	10	13	50	0.13
G9G46120	12.0	12	15	55	0.18
G9G46140	14.0	14	15	58	0.18
G9G46160	16.0	16	18	62	0.18
G9G46200	20.0	20	22	75	0.23

Mill Dia. Tolerance(mm)	Shank Dia. Tolerance
0 ~ -0.03	h5

◎ : Excellent ○ : Good

ISO Material Description	P					M				K										
	Non-alloy steel					Low alloy steel				High alloyed steel, and tool steel		Stainless steel		Grey cast iron	Nodular cast iron		Malleable cast iron			
VDI 3323	1	2	3	4	5	6	7	8	9	10	11	12	13	14	15	16	17	18	19	20
HRc	13	25	28	32	38	10	29	32	38	15	35	15	23	10	10	26	3	25	21	21
HB	125	190	250	270	300	180	275	300	350	200	325	200	240	180	180	260	160	250	130	230
Recommend	◎	◎	◎	◎	◎	◎	◎	◎	◎	◎	○	○	○	○	○	○	○	○	○	○

ISO Material Description	N				S					H											
	Aluminum-wrought alloy		Aluminum-cast, alloyed		Copper and Copper Alloys (Bronze / Brass)			Non Metallic Materials		Heat Resistant Super Alloys			Titanium Alloys	Hardened steel	Chilled Cast Iron	Hardened Cast Iron					
VDI 3323	21	22	23	24	25	26	27	28	29	30	31	32	33	34	35	36	37	38	39	40	41
HRc	21	22	23	24	25	26	27	28	29	30	31	32	33	34	35	36	37	38	39	40	41
HB	60	100	75	90	130	110	90	100			200	280	250	350	320	400 Rm	1050 Rm	550	630	400	550
Recommend	○	○	○	○	○	○	○	○	○	○	○	○	○	○	○	○	○	○	○	○	○

CARBIDE, 3 FLUTE SHORT LENGTH

- VOLLHARTMETALL, 3 SCHNEIDEN KURZ
- Fraise carbure, 3 dents, courte
- 3 TAGLIENTI, SERIE CORTA

- ▶ Suitable for dry milling applications at high temperatures.
- ▶ Excellent high-performance end mills.
- ▶ 3 flute design possesses the advantage of 2 flute and 4 flute end mill.

- ▶ Für die Trockenbearbeitung.
- ▶ Hervorragendes Preis - Leistungsverhältnis.
- ▶ 3 Schneiden verbinden die Vorteile von 2 - und 4 - schneidigen Schaffräsern.

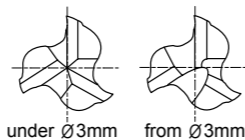

CARBIDE 3 30° DIN 6535HA TiAlN p.C574-575

Flat Shank	Page	Plain Shank	Page
END MILL HOLDER	D118 - 137	HYDRAULIC CHUCK POWER MILLING CHUCK	D15 - 46 D161 - 176
-	-	SHRINK FIT HOLDER	D47 - 72
-	-	ER COLLET CHUCK SK SLIM CHUCK	D73 - 116 D183 - 201

Unit : mm

EDP No.	Mill Diameter	Shank Diameter	Length of Cut	Overall Length
G9425010	1.0	4	3	40
G9425015	1.5	4	4.5	40
G9425020	2.0	2	8	32
G9425025	2.5	3	8	32
G9425030	3.0	3	12	32
G9425035	3.5	4	12	32
G9425040	4.0	4	12	40
G9425045	4.5	5	14	50
G9425050	5.0	5	14	50
G9425055	5.5	6	16	50
G9425060	6.0	6	16	50
G9425070	7.0	7	20	60
G9425080	8.0	8	20	60
G9425090	9.0	9	20	60
G9425100	10.0	10	22	70
G9425120	12.0	12	22	70
G9425140	14.0	14	25	75
G9425160	16.0	16	25	75
G9425200	20.0	20	32	100

Mill Dia. Tolerance(mm)	Shank Dia. Tolerance
0 ~ - 0.03	h5

◎ : Excellent ○ : Good

ISO Material Description	P										M				K					
	Non-alloy steel					Low alloy steel					High alloyed steel, and tool steel		Stainless steel		Grey cast iron	Nodular cast iron	Malleable cast iron			
VDI 3323	1	2	3	4	5	6	7	8	9	10	11	12	13	14	15	16	17	18	19	20
HRc	13	25	28	32	30	10	29	32	38	15	35	15	23	10	10	26	3	25	21	
HB	125	190	250	270	300	180	275	300	350	200	325	200	240	180	180	260	160	250	130	230
Recommend	◎	◎	◎	◎	◎	◎	◎	◎	◎	◎	◎	◎	◎	◎	◎	◎	◎	◎	◎	◎

ISO Material Description	N					S					H										
	Aluminum-wrought alloy		Aluminum-cast, alloyed			Copper and Copper Alloys (Bronze / Brass)		Non Metallic Materials			Heat Resistant Super Alloys			Titanium Alloys	Hardened steel	Chilled Cast Iron	Hardened Cast Iron				
VDI 3323	21	22	23	24	25	26	27	28	29	30	31	32	33	34	35	36	37	38	39	40	41
HRc	21	22	23	24	25	26	27	28	29	30	31	32	33	34	35	36	37	38	39	40	41
HB	60	100	75	90	130	110	90	100			200	280	250	350	320	400 Rm	1050 Rm	550	630	400	550
Recommend	○	○	○	○	○	○	○	○	○	○	○	○	○	○	○	○	○	○	○	○	○

CARBIDE, 3 FLUTE SHORT LENGTH WITH CHAMFER

- VOLLHARTMETALL, 3 SCHNEIDEN KURZ
- Fraise carbure, 3 dents, courte
- 3 TAGLIENTI, SERIE CORTA

- ▶ Suitable for dry milling applications at high temperatures.
- ▶ Excellent high-performance end mills.
- ▶ 3 flute design possesses the advantage of 2 flute and 4 flute end mill.

- ▶ Für die Trockenbearbeitung.
- ▶ Hervorragendes Preis - Leistungsverhältnis.
- ▶ 3 Schneiden verbinden die Vorteile von 2 - und 4 - schneidigen Schaffräsern.



CARBIDE 3 30° DIN 6535HA C x 45° TiAlN p.C574-575

Flat Shank	Page	Plain Shank	Page
END MILL HOLDER	D118 - 137	HYDRAULIC CHUCK POWER MILLING CHUCK	D15 - 46 D161 - 176
-	-	SHRINK FIT HOLDER	D47 - 72
-	-	ER COLLET CHUCK SK SLIM CHUCK	D73 - 116 D183 - 201

Unit : mm

EDP No.	Mill Diameter	Shank Diameter	Length of Cut	Overall Length	Chamfer
G9G47030	3.0	3	12	32	0.1
G9G47040	4.0	4	12	40	0.1
G9G47050	5.0	5	14	50	0.1
G9G47060	6.0	6	16	50	0.1
G9G47080	8.0	8	20	60	0.13
G9G47100	10.0	10	22	70	0.13
G9G47120	12.0	12	22	70	0.18
G9G47140	14.0	14	25	75	0.18
G9G47160	16.0	16	25	75	0.18
G9G47200	20.0	20	32	100	0.23

Mill Dia. Tolerance(mm)	Shank Dia. Tolerance
0 ~ - 0.03	h5

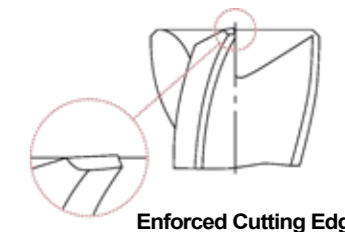

◎ : Excellent ○ : Good

ISO Material Description	P										M				K					
	Non-alloy steel					Low alloy steel					High alloyed steel, and tool steel		Stainless steel		Grey cast iron	Nodular cast iron	Malleable cast iron			
VDI 3323	1	2	3	4	5	6	7	8	9	10	11	12	13	14	15	16	17	18	19	20
HRc	13	25	28	32	30	10	29	32	38	15	35	15	23	10	10	26	3	25	21	
HB	125	190	250	270	300	180	275	300	350	200	325	200	240	180	180	260	160	250	130	230
Recommend	◎	◎	◎	◎	◎	◎	◎	◎	◎	◎	◎	◎	◎	◎	◎	◎	◎	◎	◎	◎

ISO Material Description	N					S					H										
	Aluminum-wrought alloy		Aluminum-cast, alloyed			Copper and Copper Alloys (Bronze / Brass)		Non Metallic Materials			Heat Resistant Super Alloys			Titanium Alloys	Hardened steel	Chilled Cast Iron	Hardened Cast Iron				
VDI 3323	21	22	23	24	25	26	27	28	29	30	31	32	33	34	35	36	37	38	39	40	41
HRc	21	22	23	24	25	26	27	28	29	30	31	32	33	34	35	36	37	38	39	40	41
HB	60	100	75	90	130	110	90	100			200	280	250	350	320	400 Rm	1050 Rm	550	630	400	550
Recommend	○	○	○	○	○	○	○	○	○	○	○	○	○	○	○	○	○	○	○	○	○

CARBIDE, 3 FLUTE SHORT LENGTH

- VOLLHARTMETALL, 3 SCHNEIDEN KURZ
- ① Fraise carbure, 3 dents, courte
- ② 3 TAGLIENTI, SERIE CORTA

- ▶ Suitable for dry milling applications at high temperatures.
- ▶ Excellent high-performance end mills.
- ▶ 3 flute design possesses the advantage of 2 flute and 4 flute end mill.

- ▶ Für die Trockenbearbeitung.
- ▶ Hervorragendes Preis - Leistungsverhältnis.
- ▶ 3 Schneiden verbinden die Vorteile von 2 - und 4 - schneidigen Schaffräsern.

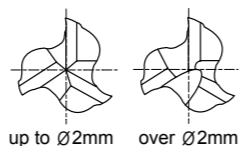

CARBIDE DIN 6527 3 30° DIN 6535HB TiAlN p.C574-575

	Flat Shank	Page	Plain Shank	Page
①	END MILL HOLDER	D118 - 137	HYDRAULIC CHUCK POWER MILLING CHUCK	D15 - 46 D161 - 176
②	-	-	SHRINK FIT HOLDER	D47 - 72
③	-	-	ER COLLET CHUCK SK SLIM CHUCK	D73 - 116 D183 - 201

Unit : mm

EDP No.	Mill Diameter	Shank Diameter	Length of Cut	Overall Length
G9439020	2.0	6	3	50
G9439030	3.0	6	4	50
G9439035	3.5	6	4	50
G9439040	4.0	6	5	54
G9439045	4.5	6	5	54
G9439050	5.0	6	6	54
G9439060	6.0	6	7	54
G9439070	7.0	8	8	58
G9439080	8.0	8	9	58
G9439090	9.0	10	10	66
G9439100	10.0	10	11	66
G9439120	12.0	12	12	73
G9439140	14.0	14	14	75
G9439160	16.0	16	16	82
G9439180	18.0	18	18	84
G9439200	20.0	20	20	92

Mill Dia. Tolerance(mm)	Shank Dia. Tolerance
0 ~ - 0.03	h5

◎ : Excellent ○ : Good

ISO Material Description	P										M				K					
	Non-alloy steel					Low alloy steel					High alloyed steel, and tool steel				Stainless steel		Grey cast iron	Nodular cast iron	Malleable cast iron	
VDI 3323	1	2	3	4	5	6	7	8	9	10	11	12	13	14	15	16	17	18	19	20
HRc	13	25	28	32	38	10	29	32	38	45	15	35	23	10	10	26	3	25	21	21
HB	125	190	250	270	300	180	275	300	350	200	200	240	180	180	180	260	160	250	130	230
Recommend	◎	◎	◎	◎	◎	◎	◎	◎	◎	◎	◎	◎	◎	◎	◎	◎	◎	◎	◎	◎

ISO Material Description	N					S					H										
	Aluminum-wrought alloy		Aluminum-cast, alloyed			Copper and Copper Alloys (Bronze / Brass)			Non Metallic Materials		Heat Resistant Super Alloys			Titanium Alloys	Hardened steel	Chilled Cast Iron	Hardened Cast Iron				
VDI 3323	21	22	23	24	25	26	27	28	29	30	31	32	33	34	35	36	37	38	39	40	41
HRc	21	22	23	24	25	26	27	28	29	30	31	32	33	34	35	36	37	38	39	40	41
HB	60	100	75	90	130	110	90	100			200	280	250	350	320	400 Rm	1050 Rm	550	630	400	550
Recommend	◎	◎	◎	◎	◎	◎	◎	◎	◎	◎	◎	◎	◎	◎	◎	◎	◎	◎	◎	◎	◎

CARBIDE, 3 FLUTE LONG LENGTH

- VOLLHARTMETALL, 3 SCHNEIDEN LANG
- ① Fraise carbure, 3 dents, longue
- ② 3 TAGLIENTI, SERIE LUNGA

- ▶ Suitable for dry milling applications at high temperatures.
- ▶ Excellent high-performance end mills.
- ▶ 3 flute design possesses the advantage of 2 flute and 4 flute end mill.

- ▶ Für die Trockenbearbeitung.
- ▶ Hervorragendes Preis - Leistungsverhältnis.
- ▶ 3 Schneiden verbinden die Vorteile von 2 - und 4 - schneidigen Schaffräsern.



CARBIDE DIN 6528 3 30° DIN 6535HA TiAlN p.C574-575

	Flat Shank	Page	Plain Shank	Page
①	END MILL HOLDER	D118 - 137	HYDRAULIC CHUCK POWER MILLING CHUCK	D15 - 46 D161 - 176
②	-	-	SHRINK FIT HOLDER	D47 - 72
③	-	-	ER COLLET CHUCK SK SLIM CHUCK	D73 - 116 D183 - 201

Unit : mm

EDP No.	Mill Diameter	Shank Diameter	Length of Cut	Overall Length
G9528035	3.5	3.5	7	50
G9528040	4.0	4	8	50
G9528045	4.5	4.5	8	50
G9528050	5.0	5	10	50
G9528055	5.5	5.5	10	57
G9528060	6.0	6	10	57
G9528065	6.5	6.5	13	60
G9528070	7.0	7	13	60
G9528075	7.5	7.5	16	63
G9528080	8.0	8	16	63
G9528085	8.5	8.5	16	67
G9528090	9.0	9	16	67
G9528095	9.5	9.5	19	72
G9528100	10.0	10	19	72
G9528110	11.0	11	22	83
G9528120	12.0	12	22	83
G9528130	13.0	13	22	83
G9528140	14.0	14	22	83
G9528150	15.0	15	26	92
G9528160	16.0	16	26	92
G9528180	18.0	18	26	92
G9528200	20.0	20	32	104

Mill Dia. Tolerance(mm)	Shank Dia. Tolerance
0 ~ - 0.03	h5

◎ : Excellent ○ : Good

ISO Material Description	P										M				K					
	Non-alloy steel					Low alloy steel					High alloyed steel, and tool steel				Stainless steel		Grey cast iron	Nodular cast iron	Malleable cast iron	
VDI 3323	1	2	3	4	5	6	7	8	9	10	11	12	13	14	15	16	17	18	19	20
HRc	13	25	28	32	38	10	29	32	38	45	15	35	23	10	10	26	3	25	21	21
HB	125	190	250	270	300	180	275	300	350	200	200	240	180	180	180	260	160	250	130	230
Recommend	◎	◎	◎	◎	◎	◎	◎	◎	◎	◎	◎	◎	◎	◎	◎	◎	◎	◎	◎	◎

ISO Material Description	N					S					H										
	Aluminum-wrought alloy		Aluminum-cast, alloyed			Copper and Copper Alloys (Bronze / Brass)			Non Metallic Materials		Heat Resistant Super Alloys			Titanium Alloys	Hardened steel	Chilled Cast Iron	Hardened Cast Iron				
VDI 3323	21	22	23	24	25	26	27	28	29	30	31	32	33	34	35	36	37	38	39	40	41
HRc	21	22	23	24	25	26	27	28	29	30	31	32	33	34	35	36	37	38	39	40	41
HB	60	100	75	90	130	110	90	100			200	280	250	350	320	400 Rm	1050 Rm	550	630	400	550
Recommend	◎	◎	◎	◎	◎	◎	◎	◎	◎	◎	◎	◎	◎	◎	◎	◎	◎	◎	◎	◎	◎



FLAT SHANK **G9433** SERIES

CARBIDE, 3 FLUTE LONG LENGTH

● **VOLLHARTMETALL, 3 SCHNEIDEN LANG**
 (●) **Fraise carbure, 3 dents, longue**
 (●) **3 TAGLIENTI, SERIE LUNGA**

- ▶ Suitable for dry milling applications at high temperatures.
- ▶ Excellent high-performance end mills.
- ▶ 3 flute design possesses the advantage of 2 flute and 4 flute end mill.

- ▶ Für die Trockenbearbeitung.
- ▶ Hervorragendes Preis - Leistungsverhältnis.
- ▶ 3 Schneiden verbinden die Vorteile von 2 - und 4 - schneidigen Schaftfräsern.

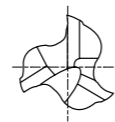

Flat Shank	Page	Plain Shank	Page
END MILL HOLDER	D118 - 137	HYDRAULIC CHUCK POWER MILLING CHUCK	D15 - 46 D161 - 176
-	-	SHRINK FIT HOLDER	D47 - 72
-	-	ER COLLET CHUCK SK SLIM CHUCK	D73 - 116 D183 - 201

Unit : mm

EDP No.	Mill Diameter	Shank Diameter	Length of Cut	Overall Length
G9433030	3.0	6	7	57
G9433040	4.0	6	8	57
G9433050	5.0	6	10	57
G9433060	6.0	6	10	57
G9433080	8.0	8	16	63
G9433090	9.0	10	16	72
G9433100	10.0	10	19	72
G9433120	12.0	12	22	83
G9433140	14.0	14	22	83
G9433160	16.0	16	26	92
G9433180	18.0	18	26	92
G9433200	20.0	20	32	104

Mill Dia. Tolerance(mm)	Shank Dia. Tolerance
0 ~ - 0.03	h5

◎ : Excellent ○ : Good

ISO Material Description	P										M				K					
	Non-alloy steel					Low alloy steel					High alloyed steel, and tool steel				Stainless steel		Grey cast iron	Nodular cast iron		Malleable cast iron
VDI 3323	1	2	3	4	5	6	7	8	9	10	11	12	13	14	15	16	17	18	19	20
HRc	13	25	28	32	38	10	29	32	38	45	15	35	40	48	10	26	3	25	21	21
HB	125	190	250	270	300	180	275	300	350	400	200	325	200	240	180	260	160	250	130	230
Recommend	◎	◎	◎	◎	◎	◎	◎	◎	◎	◎	◎	◎	◎	◎	◎	◎	◎	◎	◎	◎

ISO Material Description	N					S					H										
	Aluminum-wrought alloy		Aluminum-cast, alloyed			Copper and Copper Alloys (Bronze / Brass)			Non Metallic Materials		Heat Resistant Super Alloys					Titanium Alloys		Hardened steel	Chilled Cast Iron	Hardened Cast Iron	
VDI 3323	21	22	23	24	25	26	27	28	29	30	31	32	33	34	35	36	37	38	39	40	41
HRc	21	22	23	24	25	26	27	28	29	30	31	32	33	34	35	36	37	38	39	40	41
HB	60	100	75	90	130	110	90	100			200	280	250	350	320	400 Rm	1050 Rm	550	630	400	550
Recommend	◎	◎	◎	◎	◎	◎	◎	◎	◎	◎	◎	◎	◎	◎	◎	◎	◎	◎	◎	◎	◎



FLAT SHANK **G9G48** SERIES

CARBIDE, 3 FLUTE LONG LENGTH WITH CHAMFER

● **VOLLHARTMETALL, 3 SCHNEIDEN LANG**
 (●) **Fraise carbure, 3 dents, longue**
 (●) **3 TAGLIENTI, SERIE LUNGA**

- ▶ Suitable for dry milling applications at high temperatures.
- ▶ Excellent high-performance end mills.
- ▶ 3 flute design possesses the advantage of 2 flute and 4 flute end mill.

- ▶ Für die Trockenbearbeitung.
- ▶ Hervorragendes Preis - Leistungsverhältnis.
- ▶ 3 Schneiden verbinden die Vorteile von 2 - und 4 - schneidigen Schaftfräsern.

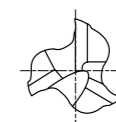

Flat Shank	Page	Plain Shank	Page
END MILL HOLDER	D118 - 137	HYDRAULIC CHUCK POWER MILLING CHUCK	D15 - 46 D161 - 176
-	-	SHRINK FIT HOLDER	D47 - 72
-	-	ER COLLET CHUCK SK SLIM CHUCK	D73 - 116 D183 - 201

Unit : mm

EDP No.	Mill Diameter	Shank Diameter	Length of Cut	Overall Length	Chamfer
G9G48030	3.0	6	7	57	0.10
G9G48040	4.0	6	8	57	0.10
G9G48050	5.0	6	10	57	0.10
G9G48060	6.0	6	10	57	0.10
G9G48080	8.0	8	16	63	0.13
G9G48100	10.0	10	19	72	0.13
G9G48120	12.0	12	22	83	0.18
G9G48140	14.0	14	22	83	0.18
G9G48160	16.0	16	26	92	0.18
G9G48200	20.0	20	32	104	0.23

Mill Dia. Tolerance(mm)	Shank Dia. Tolerance
0 ~ - 0.03	h5



Enforced Cutting Edge

◎ : Excellent ○ : Good

ISO Material Description	P										M				K					
	Non-alloy steel					Low alloy steel					High alloyed steel, and tool steel				Stainless steel		Grey cast iron	Nodular cast iron		Malleable cast iron
VDI 3323	1	2	3	4	5	6	7	8	9	10	11	12	13	14	15	16	17	18	19	20
HRc	13	25	28	32	38	10	29	32	38	45	15	35	40	48	10	26	3	25	21	21
HB	125	190	250	270	300	180	275	300	350	400	200	325	200	240	180	260	160	250	130	230
Recommend	◎	◎	◎	◎	◎	◎	◎	◎	◎	◎	◎	◎	◎	◎	◎	◎	◎	◎	◎	◎

ISO Material Description	N					S					H										
	Aluminum-wrought alloy		Aluminum-cast, alloyed			Copper and Copper Alloys (Bronze / Brass)			Non Metallic Materials		Heat Resistant Super Alloys					Titanium Alloys		Hardened steel	Chilled Cast Iron	Hardened Cast Iron	
VDI 3323	21	22	23	24	25	26	27	28	29	30	31	32	33	34	35	36	37	38	39	40	41
HRc	21	22	23	24	25	26	27	28	29	30	31	32	33	34	35	36	37	38	39	40	41
HB	60	100	75	90	130	110	90	100			200	280	250	350	320	400 Rm	1050 Rm	550	630	400	550
Recommend	◎	◎	◎	◎	◎	◎	◎	◎	◎	◎	◎	◎	◎	◎	◎	◎	◎	◎	◎	◎	◎



FLAT SHANK **G9447** SERIES

CARBIDE, 3 FLUTE 45° HELIX, LONG LENGTH

● VOLLHARTMETALL, 3 SCHNEIDEN 45° RECHTSSPIRALE LANG
 (●) Fraise carbure, 3 dents, hélice 45°, longue
 (●) 3 TAGLIENTI, ELICA 45°, SERIE LUNGA

- ▶ Suitable for dry milling applications at high temperatures.
- ▶ Excellent high-performance end mills.
- ▶ Für die Trockenbearbeitung.
- ▶ Hervorragendes Preis - Leistungsverhältnis.

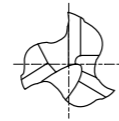

Flat Shank	Page	Plain Shank	Page
END MILL HOLDER	D118-137	HYDRAULIC CHUCK POWER MILLING CHUCK	D15-46 D161-176
-	-	SHRINK FIT HOLDER	D47-72
-	-	ER COLLET CHUCK SK SLIM CHUCK	D73-116 D183-201



Unit : mm

EDP No.	Mill Diameter	Shank Diameter	Length of Cut	Overall Length
G9447030	3.0	6	7	57
G9447035	3.5	6	7	57
G9447040	4.0	6	8	57
G9447045	4.5	6	8	57
G9447050	5.0	6	10	57
G9447060	6.0	6	10	57
G9447070	7.0	8	13	63
G9447080	8.0	8	16	63
G9447090	9.0	10	16	72
G9447100	10.0	10	19	72
G9447120	12.0	12	22	83
G9447140	14.0	14	22	83
G9447160	16.0	16	26	92
G9447180	18.0	18	26	92
G9447200	20.0	20	32	104

Mill Dia. Tolerance(mm)	Shank Dia. Tolerance
0 ~ -0.03	h5

◎ : Excellent ○ : Good

ISO Material Description	P										M				K						
	Non-alloy steel					Low alloy steel					High alloyed steel, and tool steel				Stainless steel		Grey cast iron		Nodular cast iron		
VDI 3323	1	2	3	4	5	6	7	8	9	10	11	12	13	14	15	16	17	18	19	20	21
HRc	13	25	28	32	38	10	29	32	38	45	15	35	40	45	15	26	3	25	25	21	21
HB	125	190	250	270	300	180	275	300	350	200	325	200	240	180	180	260	160	250	130	230	230
Recommend	◎	◎	◎	◎	◎	◎	◎	◎	◎	◎	◎	◎	◎	◎	◎	◎	◎	◎	◎	◎	◎

ISO Material Description	N					S					H										
	Aluminum-wrought alloy		Aluminum-cast, alloyed			Copper and Copper Alloys (Bronze / Brass)			Non Metallic Materials		Heat Resistant Super Alloys					Titanium Alloys		Hardened steel	Chilled Cast Iron	Hardened Cast Iron	
VDI 3323	21	22	23	24	25	26	27	28	29	30	31	32	33	34	35	36	37	38	39	40	41
HRc	21	22	23	24	25	26	27	28	29	30	31	32	33	34	35	36	37	38	39	40	41
HB	60	100	75	90	130	110	90	100			200	280	250	350	320	400 Rm	1050 Rm	550	630	400	550
Recommend	◎	◎	◎	◎	◎	◎	◎	◎	◎	◎	◎	◎	◎	◎	◎	◎	◎	◎	◎	◎	◎



FLAT SHANK **G9G49** SERIES

CARBIDE, 3 FLUTE 45° HELIX, LONG LENGTH WITH CHAMFER

● VOLLHARTMETALL, 3 SCHNEIDEN 45° RECHTSSPIRALE LANG
 (●) Fraise carbure, 3 dents, hélice 45°, longue
 (●) 3 TAGLIENTI, ELICA 45°, SERIE LUNGA

- ▶ Suitable for dry milling applications at high temperatures.
- ▶ Excellent high-performance end mills.
- ▶ Für die Trockenbearbeitung.
- ▶ Hervorragendes Preis - Leistungsverhältnis.

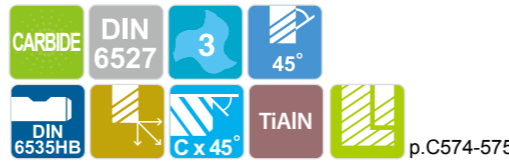
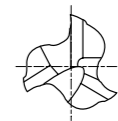

Flat Shank	Page	Plain Shank	Page
END MILL HOLDER	D118-137	HYDRAULIC CHUCK POWER MILLING CHUCK	D15-46 D161-176
-	-	SHRINK FIT HOLDER	D47-72
-	-	ER COLLET CHUCK SK SLIM CHUCK	D73-116 D183-201



Unit : mm

EDP No.	Mill Diameter	Shank Diameter	Length of Cut	Overall Length	Chamfer
G9G49030	3.0	6	7	57	0.10
G9G49040	4.0	6	8	57	0.10
G9G49050	5.0	6	10	57	0.10
G9G49060	6.0	6	10	57	0.10
G9G49080	8.0	8	16	63	0.13
G9G49100	10.0	10	19	72	0.13
G9G49120	12.0	12	22	83	0.18
G9G49140	14.0	14	22	83	0.18
G9G49160	16.0	16	26	92	0.18
G9G49200	20.0	20	32	104	0.23

Mill Dia. Tolerance(mm)	Shank Dia. Tolerance
0 ~ -0.03	h5

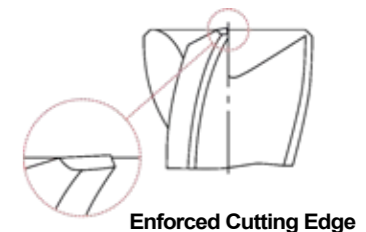

◎ : Excellent ○ : Good

ISO Material Description	P										M				K						
	Non-alloy steel					Low alloy steel					High alloyed steel, and tool steel				Stainless steel		Grey cast iron		Nodular cast iron		
VDI 3323	1	2	3	4	5	6	7	8	9	10	11	12	13	14	15	16	17	18	19	20	21
HRc	13	25	28	32	38	10	29	32	38	45	15	35	40	45	15	26	3	25	25	21	21
HB	125	190	250	270	300	180	275	300	350	200	325	200	240	180	180	260	160	250	130	230	230
Recommend	◎	◎	◎	◎	◎	◎	◎	◎	◎	◎	◎	◎	◎	◎	◎	◎	◎	◎	◎	◎	◎

ISO Material Description	N					S					H										
	Aluminum-wrought alloy		Aluminum-cast, alloyed			Copper and Copper Alloys (Bronze / Brass)			Non Metallic Materials		Heat Resistant Super Alloys					Titanium Alloys		Hardened steel	Chilled Cast Iron	Hardened Cast Iron	
VDI 3323	21	22	23	24	25	26	27	28	29	30	31	32	33	34	35	36	37	38	39	40	41
HRc	21	22	23	24	25	26	27	28	29	30	31	32	33	34	35	36	37	38	39	40	41
HB	60	100	75	90	130	110	90	100			200	280	250	350	320	400 Rm	1050 Rm	550	630	400	550
Recommend	◎	◎	◎	◎	◎	◎	◎	◎	◎	◎	◎	◎	◎	◎	◎	◎	◎	◎	◎	◎	◎



PLAIN SHANK **G9432** SERIES

CARBIDE, 4 FLUTE SHORT LENGTH

- VOLLHARTMETALL, 4 SCHNEIDEN KURZ
- Fraise carbure, 4 dents, courte
- 4 TAGLIENTI, CORTA

- ▶ Suitable for dry milling applications at high temperatures.
- ▶ Excellent high-performance end mills.
- ▶ 4 flute allows for better work piece finishes.
- ▶ Für die Trockenbearbeitung.
- ▶ Hervorragendes Preis - Leistungsverhältnis.
- ▶ 4 Schneiden erzeugen eine bessere Oberflächengüte des Werkstücks.



CARBIDE 4 30° DIN 6535HA TiAlN p.C576 Recommended ToolHolder

Flat Shank	Page	Plain Shank	Page
END MILL HOLDER	D118 - 137	HYDRAULIC CHUCK POWER MILLING CHUCK	D15 - 46 D161 - 176
-	-	SHRINK FIT HOLDER	D47 - 72
-	-	ER COLLET CHUCK SK SLIM CHUCK	D73 - 116 D183 - 201

Unit : mm

EDP No.	Mill Diameter	Shank Diameter	Length of Cut	Overall Length
G9432010	1.0	4	3	40
G9432015	1.5	4	4.5	40
G9432020	2.0	2	8	32
G9432025	2.5	2.5	8	32
G9432030	3.0	3	12	32
G9432035	3.5	3.5	12	32
G9432040	4.0	4	12	40
G9432045	4.5	4.5	14	50
G9432050	5.0	5	14	50
G9432055	5.5	5.5	16	50
G9432060	6.0	6	16	50
G9432070	7.0	7	20	60
G9432080	8.0	8	20	60
G9432090	9.0	9	20	60
G9432100	10.0	10	22	70
G9432120	12.0	12	22	70
G9432140	14.0	14	25	75
G9432160	16.0	16	25	75
G9432200	20.0	20	32	100

Mill Dia. Tolerance(mm)	Shank Dia. Tolerance
0 ~ - 0.03	h5

◎ : Excellent ○ : Good

ISO Material Description	P					M				K										
	Non-alloy steel					Low alloy steel				High alloyed steel, and tool steel		Stainless steel		Grey cast iron	Nodular cast iron	Malleable cast iron				
VDI 3323	1	2	3	4	5	6	7	8	9	10	11	12	13	14	15	16	17	18	19	20
HRc	13	25	28	32	30	10	29	32	38	15	35	15	23	10	10	26	3	25	21	21
HB	125	190	250	270	300	180	275	300	350	200	325	200	240	180	180	260	160	250	130	230
Recommend	◎	◎	◎	◎	◎	◎	◎	◎	◎	◎	◎	◎	◎	◎	◎	◎	◎	◎	◎	◎

ISO Material Description	N					S					H										
	Aluminum-wrought alloy		Aluminum-cast, alloyed			Copper and Copper Alloys (Bronze / Brass)			Non Metallic Materials		Heat Resistant Super Alloys			Titanium Alloys	Hardened steel	Chilled Cast Iron	Hardened Cast Iron				
VDI 3323	21	22	23	24	25	26	27	28	29	30	31	32	33	34	35	36	37	38	39	40	41
HRc	21	22	23	24	25	26	27	28	29	30	31	32	33	34	35	36	37	38	39	40	41
HB	60	100	75	90	130	110	90	100			200	280	250	350	320	400 Rm	1050 Rm	550	630	400	550
Recommend	○	○	○	○	○	○	○	○	○	○	○	○	○	○	○	○	○	○	○	○	○



PLAIN SHANK **G9G50** SERIES

CARBIDE, 4 FLUTE SHORT LENGTH WITH CHAMFER

- VOLLHARTMETALL, 4 SCHNEIDEN KURZ
- Fraise carbure, 4 dents, courte
- 4 TAGLIENTI, CORTA

- ▶ Suitable for dry milling applications at high temperatures.
- ▶ Excellent high-performance end mills.
- ▶ 4 flute allows for better work piece finishes.
- ▶ Für die Trockenbearbeitung.
- ▶ Hervorragendes Preis - Leistungsverhältnis.
- ▶ 4 Schneiden erzeugen eine bessere Oberflächengüte des Werkstücks.



CARBIDE 4 30° DIN 6535HA C x 45° TiAlN p.C576 Recommended ToolHolder

Flat Shank	Page	Plain Shank	Page
END MILL HOLDER	D118 - 137	HYDRAULIC CHUCK POWER MILLING CHUCK	D15 - 46 D161 - 176
-	-	SHRINK FIT HOLDER	D47 - 72
-	-	ER COLLET CHUCK SK SLIM CHUCK	D73 - 116 D183 - 201

Unit : mm

EDP No.	Mill Diameter	Shank Diameter	Length of Cut	Overall Length	Chamfer
G9G50030	3.0	3	12	32	0.10
G9G50040	4.0	4	12	40	0.10
G9G50050	5.0	5	14	50	0.10
G9G50060	6.0	6	16	50	0.10
G9G50080	8.0	8	20	60	0.13
G9G50100	10.0	10	22	70	0.13
G9G50120	12.0	12	22	70	0.18
G9G50140	14.0	14	25	75	0.18
G9G50160	16.0	16	25	75	0.18
G9G50200	20.0	20	32	100	0.23

Mill Dia. Tolerance(mm)	Shank Dia. Tolerance
0 ~ - 0.03	h5

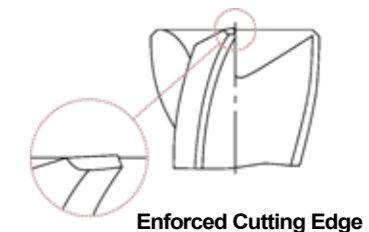

◎ : Excellent ○ : Good

ISO Material Description	P					M				K										
	Non-alloy steel					Low alloy steel				High alloyed steel, and tool steel		Stainless steel		Grey cast iron	Nodular cast iron	Malleable cast iron				
VDI 3323	1	2	3	4	5	6	7	8	9	10	11	12	13	14	15	16	17	18	19	20
HRc	13	25	28	32	30	10	29	32	38	15	35	15	23	10	10	26	3	25	21	21
HB	125	190	250	270	300	180	275	300	350	200	325	200	240	180	180	260	160	250	130	230
Recommend	◎	◎	◎	◎	◎	◎	◎	◎	◎	◎	◎	◎	◎	◎	◎	◎	◎	◎	◎	◎

ISO Material Description	N					S					H										
	Aluminum-wrought alloy		Aluminum-cast, alloyed			Copper and Copper Alloys (Bronze / Brass)			Non Metallic Materials		Heat Resistant Super Alloys			Titanium Alloys	Hardened steel	Chilled Cast Iron	Hardened Cast Iron				
VDI 3323	21	22	23	24	25	26	27	28	29	30	31	32	33	34	35	36	37	38	39	40	41
HRc	21	22	23	24	25	26	27	28	29	30	31	32	33	34	35	36	37	38	39	40	41
HB	60	100	75	90	130	110	90	100			200	280	250	350	320	400 Rm	1050 Rm	550	630	400	550
Recommend	○	○	○	○	○	○	○	○	○	○	○	○	○	○	○	○	○	○	○	○	○



PLAIN SHANK **G9A69** SERIES

CARBIDE, 4 FLUTE SHORT LENGTH

- VOLLHARTMETALL, 4 SCHNEIDEN KURZ
- (●) Fraise carbure, 4 dents, courte
- (●) 4 TAGLIENTI, CORTA

- ▶ Suitable for dry milling applications at high temperatures.
- ▶ Excellent high-performance end mills.
- ▶ 4 flute allows for better work piece finishes.
- ▶ Für die Trockenbearbeitung.
- ▶ Hervorragendes Preis - Leistungsverhältnis.
- ▶ 4 Schneiden erzeugen eine bessere Oberflächengüte des Werkstücks.



CARBIDE 4 30° DIN 6535HA TiAlN p.C576

Flat Shank	Page	Plain Shank	Page
END MILL HOLDER	D118-137	HYDRAULIC CHUCK POWER MILLING CHUCK	D15-46 D161-176
-	-	SHRINK FIT HOLDER	D47-72
-	-	ER COLLET CHUCK SK SLIM CHUCK	D73-116 D183-201

Recommended ToolHolder

Unit : mm

EDP No.	Mill Diameter	Shank Diameter	Length of Cut	Overall Length
G9A69010	1.0	3	3	39
G9A69015	1.5	3	5	39
G9A69020	2.0	3	7	39
G9A69025	2.5	3	7	39
G9A69030	3.0	3	10	39
G9A69040	4.0	4	14	51
G9A69050	5.0	5	16	51
G9A69060	6.0	6	19	64
G9A69080	8.0	8	21	64
G9A69100	10.0	10	22	70
G9A69120	12.0	12	25	76
G9A69160	16.0	16	32	89
G9A69200	20.0	20	38	102

Mill Dia. Tolerance(mm)	Shank Dia. Tolerance
0 ~ -0.03	h5

◎ : Excellent ○ : Good

ISO	P										M				K						
	Non-alloy steel					Low alloy steel					High alloyed steel, and tool steel				Stainless steel		Grey cast iron		Nodular cast iron	Malleable cast iron	
Material Description	1	2	3	4	5	6	7	8	9	10	11	12	13	14	15	16	17	18	19	20	
VDI 3323	1	2	3	4	5	6	7	8	9	10	11	12	13	14	15	16	17	18	19	20	
HRc	13	25	28	32	38	10	29	32	38	15	35	15	23	10	10	26	3	25	21	21	
HB	125	190	250	270	300	180	275	300	350	200	325	200	240	180	180	260	160	250	130	230	
Recommend	◎	◎	◎	◎	◎	◎	◎	◎	◎	◎	◎	◎	◎	◎	◎	◎	◎	◎	◎	◎	◎

ISO	N					S					H											
	Aluminum-wrought alloy		Aluminum-cast, alloyed			Copper and Copper Alloys (Bronze / Brass)			Non Metallic Materials		Heat Resistant Super Alloys					Titanium Alloys		Hardened steel	Chilled Cast Iron	Hardened Cast Iron		
Material Description	21	22	23	24	25	26	27	28	29	30	31	32	33	34	35	36	37	38	39	40	41	
VDI 3323	21	22	23	24	25	26	27	28	29	30	31	32	33	34	35	36	37	38	39	40	41	
HRc	21	22	23	24	25	26	27	28	29	30	31	32	33	34	35	36	37	38	39	40	41	
HB	60	100	75	90	130	110	90	100			200	280	250	350	320	400 Rm	1050 Rm	550	630	400	550	
Recommend	◎	◎	◎	◎	◎	◎	◎	◎	◎	◎	◎	◎	◎	◎	◎	◎	◎	◎	◎	◎	◎	◎



FLAT SHANK **G9448** SERIES

CARBIDE, 4 FLUTE SHORT LENGTH

- VOLLHARTMETALL, 4 SCHNEIDEN KURZ
- (●) Fraise carbure, 4 dents, courte
- (●) 4 TAGLIENTI, SERIE CORTA

- ▶ Suitable for dry milling applications at high temperatures.
- ▶ Excellent high-performance end mills.
- ▶ 4 flute allows for better work piece finishes.
- ▶ Für die Trockenbearbeitung.
- ▶ Hervorragendes Preis - Leistungsverhältnis.
- ▶ 4 Schneiden erzeugen eine bessere Oberflächengüte des Werkstücks.



CARBIDE DIN 6527 4 30° DIN 6535HB TiAlN p.C576

Flat Shank	Page	Plain Shank	Page
END MILL HOLDER	D118-137	HYDRAULIC CHUCK POWER MILLING CHUCK	D15-46 D161-176
-	-	SHRINK FIT HOLDER	D47-72
-	-	ER COLLET CHUCK SK SLIM CHUCK	D73-116 D183-201

Recommended ToolHolder

Unit : mm

EDP No.	Mill Diameter	Shank Diameter	Length of Cut	Overall Length
G9448020	2.0	6	4	50
G9448025	2.5	6	4	50
G9448030	3.0	6	5	50
G9448035	3.5	6	6	50
G9448040	4.0	6	8	54
G9448045	4.5	6	8	54
G9448050	5.0	6	9	54
G9448060	6.0	6	10	54
G9448070	7.0	8	11	58
G9448080	8.0	8	12	58
G9448090	9.0	10	13	66
G9448100	10.0	10	14	66
G9448120	12.0	12	16	73
G9448140	14.0	14	18	75
G9448160	16.0	16	22	82
G9448180	18.0	18	24	84
G9448200	20.0	20	26	92

Mill Dia. Tolerance(mm)	Shank Dia. Tolerance
0 ~ -0.03	h5

◎ : Excellent ○ : Good

ISO	P										M				K						
	Non-alloy steel					Low alloy steel					High alloyed steel, and tool steel				Stainless steel		Grey cast iron		Nodular cast iron	Malleable cast iron	
Material Description	1	2	3	4	5	6	7	8	9	10	11	12	13	14	15	16	17	18	19	20	
VDI 3323	1	2	3	4	5	6	7	8	9	10	11	12	13	14	15	16	17	18	19	20	
HRc	13	25	28	32	38	10	29	32	38	15	35	15	23	10	10	26	3	25	21	21	
HB	125	190	250	270	300	180	275	300	350	200	325	200	240	180	180	260	160	250	130	230	
Recommend	◎	◎	◎	◎	◎	◎	◎	◎	◎	◎	◎	◎	◎	◎	◎	◎	◎	◎	◎	◎	◎

ISO	N					S					H											
	Aluminum-wrought alloy		Aluminum-cast, alloyed			Copper and Copper Alloys (Bronze / Brass)			Non Metallic Materials		Heat Resistant Super Alloys					Titanium Alloys		Hardened steel	Chilled Cast Iron	Hardened Cast Iron		
Material Description	21	22	23	24	25	26	27	28	29	30	31	32	33	34	35	36	37	38	39	40	41	
VDI 3323	21	22	23	24	25	26	27	28	29	30	31	32	33	34	35	36	37	38	39	40	41	
HRc	21	22	23	24	25	26	27	28	29	30	31	32	33	34	35	36	37	38	39	40	41	
HB	60	100	75	90	130	110	90	100			200	280	250	350	320	400 Rm	1050 Rm	550	630	400	550	
Recommend	◎	◎	◎	◎	◎	◎	◎	◎	◎	◎	◎	◎	◎	◎	◎	◎	◎	◎	◎	◎	◎	◎



PLAIN SHANK **G9540** SERIES

CARBIDE, 4 FLUTE LONG LENGTH

- VOLLHARTMETALL, 4 SCHNEIDEN LANG
- Fraise carbure, 4 dents, longue
- 4 TAGLIENTI, SERIE LUNGA

- ▶ Suitable for dry milling applications at high temperatures.
- ▶ Excellent high-performance end mills.
- ▶ 4 flute allows for better work piece finishes.
- ▶ Für die Trockenbearbeitung.
- ▶ Hervorragendes Preis - Leistungsverhältnis.
- ▶ 4 Schneiden erzeugen eine bessere Oberflächengüte des Werkstücks.



CARBIDE DIN 6528 4 $\approx 30^\circ$ DIN 6535HA TiAIN p.C576

Flat Shank	Page	Plain Shank	Page
END MILL HOLDER	D118 - 137	HYDRAULIC CHUCK POWER MILLING CHUCK	D15 - 46 D161 - 176
-	-	SHRINK FIT HOLDER	D47 - 72
-	-	ER COLLET CHUCK SK SLIM CHUCK	D73 - 116 D183 - 201

Unit : mm

EDP No.	Mill Diameter	Shank Diameter	Length of Cut	Overall Length
G9540035	3.5	3.5	10	50
G9540040	4.0	4	11	50
G9540045	4.5	4.5	11	50
G9540050	5.0	5	13	50
G9540055	5.5	5.5	13	57
G9540060	6.0	6	13	57
G9540065	6.5	6.5	16	60
G9540070	7.0	7	16	60
G9540075	7.5	7.5	19	63
G9540080	8.0	8	19	63
G9540085	8.5	8.5	19	67
G9540090	9.0	9	19	67
G9540095	9.5	9.5	22	72
G9540100	10.0	10	22	72
G9540110	11.0	11	26	83
G9540120	12.0	12	26	83
G9540130	13.0	13	26	83
G9540140	14.0	14	26	83
G9540150	15.0	15	32	92
G9540160	16.0	16	32	92
G9540180	18.0	18	32	92
G9540200	20.0	20	38	104

Mill Dia. Tolerance(mm)	Shank Dia. Tolerance
0 ~ - 0.03	h5

◎ : Excellent ○ : Good

ISO Material Description	P										M				K						
	Non-alloy steel					Low alloy steel					High alloyed steel, and tool steel				Stainless steel		Grey cast iron	Nodular cast iron		Malleable cast iron	
VDI 3323	1	2	3	4	5	6	7	8	9	10	11	12	13	14	15	16	17	18	19	20	
HRc	13	25	28	32	32	10	29	32	38	15	35	15	23	10	10	26	3	25	21	21	
HB	125	190	250	270	300	180	275	300	350	200	325	200	240	180	180	260	160	250	130	230	
Recommend	◎	◎	◎	◎	◎	◎	◎	◎	◎	◎	◎	◎	◎	◎	◎	◎	◎	◎	◎	◎	◎

ISO Material Description	N					S					H											
	Aluminum-wrought alloy		Aluminum-cast, alloyed			Copper and Copper Alloys (Bronze / Brass)			Non Metallic Materials		Heat Resistant Super Alloys					Titanium Alloys		Hardened steel	Chilled Cast Iron	Hardened Cast Iron		
VDI 3323	21	22	23	24	25	26	27	28	29	30	31	32	33	34	35	36	37	38	39	40	41	
HRc											15	30	25	38	34			55	60	42	55	
HB	60	100	75	90	130	110	90	100			200	280	250	350	320	400 Rm	1050 Rm	550	630	400	550	
Recommend	○	○	○	○	○	○	○	○	○	○	○	○	○	○	○	○	○	○	○	○	○	○



FLAT SHANK **G9449** SERIES

CARBIDE, 4 FLUTE LONG LENGTH

- VOLLHARTMETALL, 4 SCHNEIDEN LANG
- Fraise carbure, 4 dents, longue
- 4 TAGLIENTI, SERIE LUNGA

- ▶ Suitable for dry milling applications at high temperatures.
- ▶ Excellent high-performance end mills.
- ▶ 4 flute allows for better work piece finishes.
- ▶ Für die Trockenbearbeitung.
- ▶ Hervorragendes Preis - Leistungsverhältnis.
- ▶ 4 Schneiden erzeugen eine bessere Oberflächengüte des Werkstücks.



CARBIDE DIN 6527 4 $\approx 30^\circ$ DIN 6535HB DIN 6535HA TiAIN p.C576

Flat Shank	Page	Plain Shank	Page
END MILL HOLDER	D118 - 137	HYDRAULIC CHUCK POWER MILLING CHUCK	D15 - 46 D161 - 176
-	-	SHRINK FIT HOLDER	D47 - 72
-	-	ER COLLET CHUCK SK SLIM CHUCK	D73 - 116 D183 - 201

Unit : mm

EDP No.	Mill Diameter	Shank Diameter	Length of Cut	Overall Length
G9449901	2.0	● 3	7	38
G9449030	3.0	6	8	57
G9449035	3.5	6	10	57
G9449040	4.0	6	11	57
G9449045	4.5	6	11	57
G9449050	5.0	6	13	57
G9449060	6.0	6	13	57
G9449070	7.0	8	16	63
G9449080	8.0	8	19	63
G9449090	9.0	10	19	72
G9449100	10.0	10	22	72
G9449120	12.0	12	26	83
G9449140	14.0	14	26	83
G9449160	16.0	16	32	92
G9449180	18.0	18	32	92
G9449200	20.0	20	38	104

● with plain shank

Mill Dia. Tolerance(mm)	Shank Dia. Tolerance
0 ~ - 0.03	h5

◎ : Excellent ○ : Good

ISO Material Description	P										M				K						
	Non-alloy steel					Low alloy steel					High alloyed steel, and tool steel				Stainless steel		Grey cast iron	Nodular cast iron		Malleable cast iron	
VDI 3323	1	2	3	4	5	6	7	8	9	10	11	12	13	14	15	16	17	18	19	20	
HRc	13	25	28	32	32	10	29	32	38	15	35	15	23	10	10	26	3	25	21	21	
HB	125	190	250	270	300	180	275	300	350	200	325	200	240	180	180	260	160	250	130	230	
Recommend	◎	◎	◎	◎	◎	◎	◎	◎	◎	◎	◎	◎	◎	◎	◎	◎	◎	◎	◎	◎	◎

ISO Material Description	N					S					H											
	Aluminum-wrought alloy		Aluminum-cast, alloyed			Copper and Copper Alloys (Bronze / Brass)			Non Metallic Materials		Heat Resistant Super Alloys					Titanium Alloys		Hardened steel	Chilled Cast Iron	Hardened Cast Iron		
VDI 3323	21	22	23	24	25	26	27	28	29	30	31	32	33	34	35	36	37	38	39	40	41	
HRc											15	30	25	38	34			55	60	42	55	
HB	60	100	75	90	130	110	90	100			200	280	250	350	320	400 Rm	1050 Rm	550	630	400	550	
Recommend	○	○	○	○	○	○	○	○	○	○	○	○	○	○	○	○	○	○	○	○	○	○



FLAT SHANK **G9G51** SERIES

CARBIDE, 4 FLUTE LONG LENGTH WITH CHAMFER

● **VOLLHARTMETALL, 4 SCHNEIDEN LANG**
 () **Fraise carbure, 4 dents, longue**
 () **4 TAGLIENTI, SERIE LUNGA**

- ▶ Suitable for dry milling applications at high temperatures.
- ▶ Excellent high-performance end mills.
- ▶ 4 flute allows for better work piece finishes.
- ▶ Für die Trockenbearbeitung.
- ▶ Hervorragendes Preis - Leistungsverhältnis.
- ▶ 4 Schneiden erzeugen eine bessere Oberflächengüte des Werkstücks.

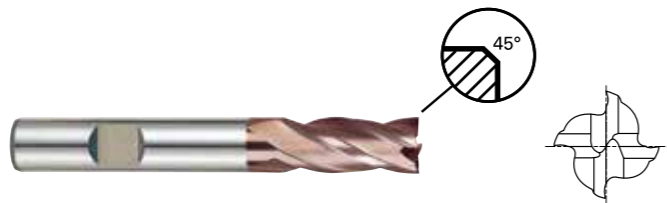

CARBIDE DIN 6527 4 $\approx 30^\circ$
 DIN 6535HB C x 45° TiAlN p.C576

	Flat Shank	Page	Plain Shank	Page
END MILL HOLDER	D118 - 137		HYDRAULIC CHUCK POWER MILLING CHUCK	D15 - 46 D161 - 176
	-	-	SHRINK FIT HOLDER	D47 - 72
	-	-	ER COLLET CHUCK SK SLIM CHUCK	D73 - 116 D183 - 201

Unit : mm

EDP No.	Mill Diameter	Shank Diameter	Length of Cut	Overall Length	Chamfer
G9G51030	3.0	6	8	57	0.10
G9G51040	4.0	6	11	57	0.10
G9G51050	5.0	6	13	57	0.10
G9G51060	6.0	6	13	57	0.10
G9G51080	8.0	8	19	63	0.13
G9G51100	10.0	10	22	72	0.13
G9G51120	12.0	12	26	83	0.18
G9G51140	14.0	14	26	83	0.18
G9G51160	16.0	16	32	92	0.18
G9G51200	20.0	20	38	104	0.23

Mill Dia. Tolerance(mm)	Shank Dia. Tolerance
0 ~ - 0.03	h5

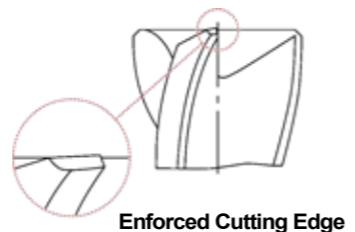

◎ : Excellent ○ : Good

ISO Material Description	P					M				K										
	Non-alloy steel					Low alloy steel				High alloyed steel, and tool steel										
VDI 3323	1	2	3	4	5	6	7	8	9	10	11	12	13	14	15	16	17	18	19	20
HRc	13	25	28	32	38	10	29	32	38	15	35	15	23	10	10	26	3	25	21	
HB	125	190	250	270	300	180	275	300	350	200	325	200	240	180	180	260	160	250	130	230
Recommend	◎	◎	◎	◎	◎	◎	◎	◎	◎	◎	◎	○	○	○	○	○	○	○	○	○

ISO Material Description	N					S				H											
	Aluminum-cast, alloyed					Copper and Copper Alloys (Bronze / Brass)				Non Metallic Materials											
VDI 3323	21	22	23	24	25	26	27	28	29	30	31	32	33	34	35	36	37	38	39	40	41
HRc											15	30	25	38	34	55	60	42	55		
HB	60	100	75	90	130	110	90	100			200	280	250	350	320	400 Rm	1050 Rm	550	630	400	550
Recommend	○	○	○	○	○	○	○	○	○	○	○	○	○	○	○	○	○	○	○	○	○



PLAIN SHANK **G9H73** SERIES
 FLAT SHANK **G9H74** SERIES

CARBIDE, 4 FLUTE MULTIPLE HELIX SHORT LENGTH WITH CHAMFER

● **HARTMETALL, 4-SCHNEIDEN-VARIABLE DRALL KURZE LÄNGE MIT FASE**
 () **Fraise carbure, 4 dents, hélice multiple, courte**
 () **MD, 4 TAGLIENTI, PASSO ED ELICA DIFFERENZIATI, SPIGOLO CON SMUSSO 45°**

- ▶ New Coating enhances heat and oxidation resistance
- ▶ Multiple Helix Designed for Optimal Chip Formation and Chip Evacuation
- ▶ Unique Geometry applied to Reduce Vibration
- ▶ Neue Beschichtung verbessert die Hitze- und Oxidationsbeständigkeit
- ▶ Multiple Helix Design zur Reduzierung von Vibrationen
- ▶ Einzigartige Geometrie für optimale Spanbildung und Spanabfuhr



CARBIDE DIN 6527 4 35°/37°
 PLAIN FLAT C x 45° X Coating p.C577

	Flat Shank	Page	Plain Shank	Page
END MILL HOLDER	D118 - 137		HYDRAULIC CHUCK POWER MILLING CHUCK	D15 - 46 D161 - 176
	-	-	SHRINK FIT HOLDER	D47 - 72
	-	-	ER COLLET CHUCK SK SLIM CHUCK	D73 - 116 D183 - 201

Unit : mm

EDP No.		Mill Diameter	Shank Diameter	Length of Cut	Overall Length	Chamfer
PLAIN	FLAT					
G9H73030N	G9H74030N	3.0	6	5	50	0.10
G9H73040N	G9H74040N	4.0	6	8	54	0.15
G9H73050N	G9H74050N	5.0	6	9	54	0.15
G9H73060N	G9H74060N	6.0	6	10	54	0.20
G9H73080N	G9H74080N	8.0	8	12	58	0.20
G9H73100N	G9H74100N	10.0	10	14	66	0.30
G9H73120N	G9H74120N	12.0	12	16	73	0.35
G9H73160N	G9H74160N	16.0	16	22	82	0.40
G9H73200N	G9H74200N	20.0	20	26	92	0.50

Mill Dia. Tolerance(mm)	Shank Dia. Tolerance
0 ~ - 0.03	h5

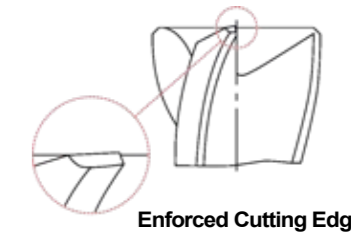

Unequal Index
 Exclusively Designed Unique Geometry applied to Reduce Vibration and also to achieve Excellent Chip Evacuation with Better Surface Finish

Multiple Helix
 Multiple Helix Designed for Optimal Chip Formation and Chip Evacuation Concluding Faster and Heavier Cutting making Higher Productivity

◎ : Excellent ○ : Good

ISO Material Description	P					M				K										
	Non-alloy steel					Low alloy steel				High alloyed steel, and tool steel										
VDI 3323	1	2	3	4	5	6	7	8	9	10	11	12	13	14	15	16	17	18	19	20
HRc	13	25	28	32	38	10	29	32	38	15	35	15	23	10	10	26	3	25	21	
HB	125	190	250	270	300	180	275	300	350	200	325	200	240	180	180	260	160	250	130	230
Recommend	◎	◎	◎	◎	◎	◎	◎	◎	◎	◎	◎	○	○	○	○	○	○	○	○	○

ISO Material Description	N					S				H											
	Aluminum-cast, alloyed					Copper and Copper Alloys (Bronze / Brass)				Non Metallic Materials											
VDI 3323	21	22	23	24	25	26	27	28	29	30	31	32	33	34	35	36	37	38	39	40	41
HRc											15	30	25	38	34	55	60	42	55		
HB	60	100	75	90	130	110	90	100			200	280	250	350	320	400 Rm	1050 Rm	550	630	400	550
Recommend	○	○	○	○	○	○	○	○	○	○	○	○	○	○	○	○	○	○	○	○	○



PLAIN SHANK **G9H75** SERIES
 FLAT SHANK **G9H76** SERIES

CARBIDE, 4 FLUTE MULTIPLE HELIX LONG LENGTH WITH CHAMFER

● **HARTMETALL, 4-SCHNEIDEN-VARIABLER LANG LÄNGE MIT FASE**
 (●) **Fraise carbure, 4 dents, hélice multiple, longue**
 (●) **MD, 4 TAGLIENTI, PASSO ED ELICA DIFFERENZIATI, CON SMUSSO 45° - SERIE LUNGA**

- ▶ New Coating enhances heat and oxidation resistance
- ▶ Multiple Helix Designed for Optimal Chip Formation and Chip Evacuation
- ▶ Unique Geometry applied to Reduce Vibration
- ▶ Neue Beschichtung verbessert die Hitze- und Oxidationsbeständigkeit
- ▶ Multiple Helix Design zur Reduzierung von Vibrationen
- ▶ Einzigartige Geometrie für optimale Spanbildung und Spanabfuhr

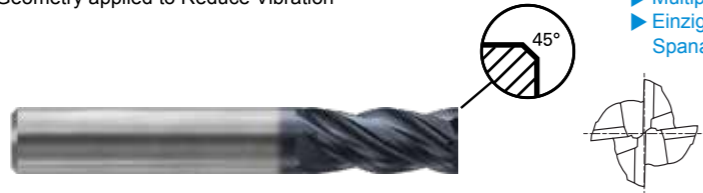

CARBIDE DIN 6527 4 35°/37°
 PLAIN FLAT C x 45° X Coating p.C577

Flat Shank	Page	Plain Shank	Page
END MILL HOLDER	D118 - 137	HYDRAULIC CHUCK POWER MILLING CHUCK	D15 - 46 D161 - 176
-	-	SHRINK FIT HOLDER	D47 - 72
-	-	ER COLLET CHUCK SK SLIM CHUCK	D73 - 116 D183 - 201

Unit : mm

EDP No.		Mill Diameter	Shank Diameter	Length of Cut	Overall Length	Chamfer
PLAIN	FLAT					
G9H75030N	G9H76030N	3.0	6	8	57	0.10
G9H75040N	G9H76040N	4.0	6	11	57	0.15
G9H75050N	G9H76050N	5.0	6	13	57	0.15
G9H75060N	G9H76060N	6.0	6	13	57	0.20
G9H75080N	G9H76080N	8.0	8	19	63	0.20
G9H75100N	G9H76100N	10.0	10	22	72	0.30
G9H75120N	G9H76120N	12.0	12	26	83	0.35
G9H75160N	G9H76160N	16.0	16	32	92	0.40
G9H75200N	G9H76200N	20.0	20	38	104	0.50

Mill Dia. Tolerance(mm)	Shank Dia. Tolerance
0 ~ -0.03	h5

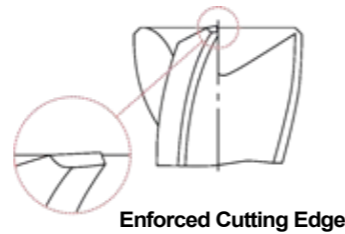

Unequal Index
 Exclusively Designed Unique Geometry applied to Reduce Vibration and also to achieve Excellent Chip Evacuation with Better Surface Finish

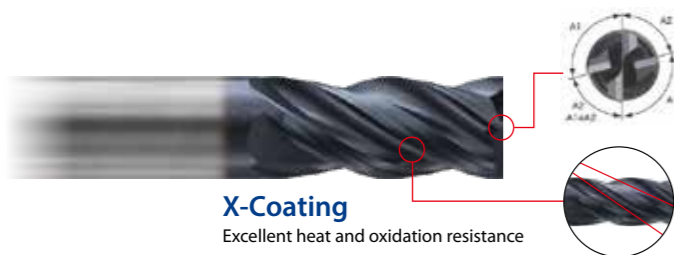

Multiple Helix
 Multiple Helix Designed for Optimal Chip Formation and Chip Evacuation Concluding Faster and Heavier Cutting making Higher Productivity

◎ : Excellent ○ : Good

ISO Material Description	P										M				K					
	Non-alloy steel					Low alloy steel					High alloyed steel, and tool steel		Stainless steel		Grey cast iron		Nodular cast iron		Malleable cast iron	
VDI 3323	1	2	3	4	5	6	7	8	9	10	11	12	13	14	15	16	17	18	19	20
HRc	13	25	28	32	38	10	29	32	38	15	35	15	23	10	10	26	3	25	21	
HB	125	190	250	270	300	180	275	300	350	200	325	200	240	180	180	260	160	250	130	230
Recommend	◎	◎	◎	◎	◎	◎	◎	◎	◎	◎	◎	◎	◎	◎	◎	◎	◎	◎	◎	◎



PLAIN SHANK **G9453** SERIES

CARBIDE, 4 FLUTE EXTRA LONG LENGTH

● **VOLLHARTMETALL, 4 SCHNEIDEN EXTRA LANG**
 (●) **Fraise carbure, 4 dents, extra-longue**
 (●) **4 TAGLIENTI, SERIE EXTRA LUNGA**

- ▶ Suitable for dry milling applications at high temperatures.
- ▶ Excellent high-performance end mills.
- ▶ 4 flute allows for better work piece finishes.
- ▶ Für die Trockenbearbeitung.
- ▶ Hervorragendes Preis - Leistungsverhältnis.
- ▶ 4 Schneiden erzeugen eine bessere Oberflächengüte des Werkstücks.



CARBIDE 4 30° DIN 6535HA TiAlN p.C576

Flat Shank	Page	Plain Shank	Page
END MILL HOLDER	D118 - 137	HYDRAULIC CHUCK POWER MILLING CHUCK	D15 - 46 D161 - 176
-	-	SHRINK FIT HOLDER	D47 - 72
-	-	ER COLLET CHUCK SK SLIM CHUCK	D73 - 116 D183 - 201

Unit : mm

EDP No.	Mill Diameter	Shank Diameter	Length of Cut	Overall Length
G9453903	3.0	3	20	60
G9453030	3.0	3	30	75
G9453904	4.0	4	20	60
G9453040	4.0	4	30	75
G9453905	5.0	5	25	75
G9453050	5.0	5	40	100
G9453906	6.0	6	30	75
G9453060	6.0	6	50	150
G9453908	8.0	8	30	75
G9453080	8.0	8	50	150
G9453910	10.0	10	40	100
G9453100	10.0	10	60	150
G9453912	12.0	12	45	100
G9453120	12.0	12	75	150
G9453914	14.0	14	45	100
G9453140	14.0	14	65	150
G9453916	16.0	16	45	100
G9453160	16.0	16	65	150
G9453918	18.0	18	45	100
G9453180	18.0	18	65	150
G9453920	20.0	20	45	100
G9453200	20.0	20	65	150

Mill Dia. Tolerance(mm)	Shank Dia. Tolerance
0 ~ -0.03	h5

◎ : Excellent ○ : Good

ISO Material Description	P										M				K					
	Non-alloy steel					Low alloy steel					High alloyed steel, and tool steel		Stainless steel		Grey cast iron		Nodular cast iron		Malleable cast iron	
VDI 3323	1	2	3	4	5	6	7	8	9	10	11	12	13	14	15	16	17	18	19	20
HRc	13	25	28	32	38	10	29	32	38	15	35	15	23	10	10	26	3	25	21	
HB	125	190	250	270	300	180	275	300	350	200	325	200	240	180	180	260	160	250	130	230
Recommend	◎	◎	◎	◎	◎	◎	◎	◎	◎	◎	◎	◎	◎	◎	◎	◎	◎	◎	◎	◎



PLAIN SHANK **G9F45** SERIES

PLAIN SHANK **G9F46** SERIES

CARBIDE, 4&6 FLUTE 45° HELIX SHORT / LONG LENGTH

● VOLLHARTMETALL, 4&6 SCHNEIDEN 45° RECHTSSPIRALE KURZ / LANG
 () Fraise carbure, 4&6 dents, hélice 45°, courte / longue
 () 4&6 TAGLIENTI, ELICA 45°, SERIE CORTA / LUNGA

- Suitable for dry milling applications at high temperatures.
- Excellent high-performance end mills.
- Für die Trockenbearbeitung geeignet.
- Exzellente Hochleistungs Mühlen.



Flat Shank	Page	Plain Shank	Page
END MILL HOLDER	D118-137	HYDRAULIC CHUCK POWER MILLING CHUCK	D15-46 D161-176
-	-	SHRINK FIT HOLDER	D47-72
-	-	ER COLLET CHUCK SK SLIM CHUCK	D73-116 D183-201

SHORT

Unit : mm

EDP No.	Mill Diameter	Shank Diameter	Length of Cut	Overall Length	No. of Flute
G9F45030	3.0	4	6	50	4
G9F45040	4.0	4	11	50	4
G9F45050	5.0	6	13	50	6
G9F45060	6.0	6	16	50	6
G9F45080	8.0	8	19	60	6
G9F45100	10.0	10	22	75	6
G9F45120	12.0	12	26	75	6
G9F45140	14.0	14	30	90	6
G9F45160	16.0	16	32	100	6
G9F45180	18.0	18	38	100	6
G9F45200	20.0	20	38	100	6

LONG

Unit : mm

EDP No.	Mill Diameter	Shank Diameter	Length of Cut	Overall Length	No. of Flute
G9F46120	12.0	12	50	100	6
G9F46160	16.0	16	65	150	6
G9F46200	20.0	20	75	150	6

Mill Dia. Tolerance(mm)	Shank Dia. Tolerance
0 ~ -0.03	h5

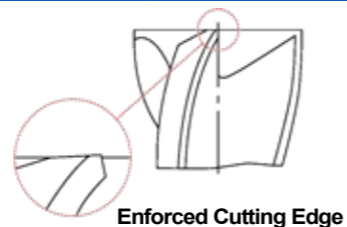

Enforced Cutting Edge

◎ : Excellent ○ : Good

ISO Material Description	P										M				K					
	Non-alloy steel					Low alloy steel					High alloyed steel, and tool steel		Stainless steel		Grey cast iron	Nodular cast iron		Malleable cast iron		
VDI 3323	1	2	3	4	5	6	7	8	9	10	11	12	13	14	15	16	17	18	19	20
HRc	13	25	28	32	30	10	29	32	38	15	35	15	23	10	10	26	3	25	21	21
HB	125	190	250	270	300	180	275	300	350	200	325	200	240	180	180	260	160	250	130	230
Recommend	○	○	○	○	○	○	○	○	○	◎	◎	○	○	○	○	○	○	○	○	○

ISO Material Description	N					S					H										
	Aluminum-wrought alloy		Aluminum-cast, alloyed			Copper and Copper Alloys (Bronze / Brass)			Non Metallic Materials		Heat Resistant Super Alloys			Titanium Alloys		Hardened steel	Chilled Cast Iron	Hardened Cast Iron			
VDI 3323	21	22	23	24	25	26	27	28	29	30	31	32	33	34	35	36	37	38	39	40	41
HRc	21	22	23	24	25	26	27	28	29	30	31	32	33	34	35	36	37	38	39	40	41
HB	60	100	75	90	130	110	90	100			200	280	250	350	320	400 Rm	1050 Rm	550	630	400	550
Recommend	○	○	○	○	○	○	○	○	○	○	○	○	○	○	○	○	○	○	○	○	○



FLAT SHANK **G9A42** SERIES

CARBIDE, MULTI FLUTE LONG LENGTH ROUGHING - COARSE

● VOLLHARTMETALL, MEHRSCHEIDEN LANG SCHRUPPFRÄSER - GROB
 () Fraise carbure, multi-dents, ébauche, pas grossier, longue
 () 3 - 4 - 5 TAGLIENTI, PER SGROSSATURA, SERIE LUNGA - Bombato grosso

- Suitable for dry milling applications at high temperatures.
- Excellent high-performance end mills.
- Fast chip ejection.
- Für die Trockenbearbeitung.
- Hervorragendes Preis - Leistungsverhältnis.
- Guter Spanauswurf.

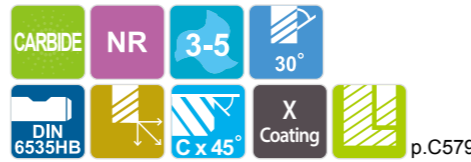
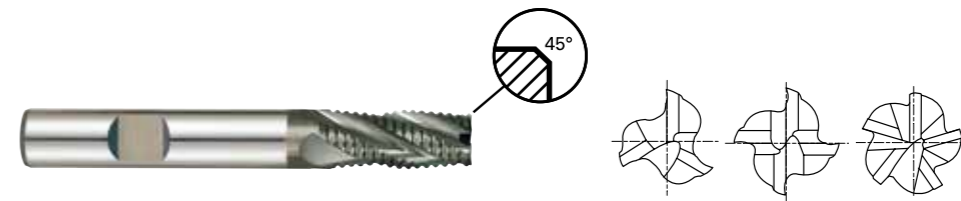

Flat Shank	Page	Plain Shank	Page
END MILL HOLDER	D118-137	HYDRAULIC CHUCK POWER MILLING CHUCK	D15-46 D161-176
-	-	SHRINK FIT HOLDER	D47-72
-	-	ER COLLET CHUCK SK SLIM CHUCK	D73-116 D183-201

EDP No.	Mill Diameter	Shank Diameter	Length of Cut	Overall Length	No. of Flute	Chamfer
	h10	h5				
G9A42060	6.0	6	16	57	3.00	0.60
G9A42080	8.0	8	16	63	3.00	0.60
G9A42100	10.0	10	22	72	4.00	0.60
G9A42120	12.0	12	26	83	4.00	0.74
G9A42140	14.0	14	26	83	4.00	0.94
G9A42160	16.0	16	32	92	4.00	0.94
G9A42180	18.0	18	32	92	4.00	0.94
G9A42200	20.0	20	38	104	4.00	0.94
G9A42250	25.0	25	45	121	5.00	0.94

Tolerances according to DIN 7160 & 7161

	Tolerance range in μm				
	Nominal-Diameter in mm				
	from 1 to 3	over 3 to 6	over 6 to 10	over 10 to 18	over 18 to 30
h10	0 -40	0 -48	0 -58	0 -70	0 -84
h5	0 -4	0 -5	0 -6	0 -8	0 -9

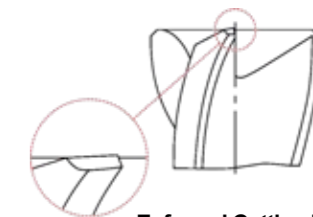

Enforced Cutting Edge

◎ : Excellent ○ : Good

ISO Material Description	P										M				K					
	Non-alloy steel					Low alloy steel					High alloyed steel, and tool steel		Stainless steel		Grey cast iron	Nodular cast iron		Malleable cast iron		
VDI 3323	1	2	3	4	5	6	7	8	9	10	11	12	13	14	15	16	17	18	19	20
HRc	13	25	28	32	30	10	29	32	38	15	35	15	23	10	10	26	3	25	21	21
HB	125	190	250	270	300	180	275	300	350	200	325	200	240	180	180	260	160	250	130	230
Recommend	◎	◎	◎	◎	◎	◎	◎	◎	◎	◎	◎	○	○	○	○	○	○	○	○	○

ISO Material Description	N					S					H										
	Aluminum-wrought alloy		Aluminum-cast, alloyed			Copper and Copper Alloys (Bronze / Brass)			Non Metallic Materials		Heat Resistant Super Alloys			Titanium Alloys		Hardened steel	Chilled Cast Iron	Hardened Cast Iron			
VDI 3323	21	22	23	24	25	26	27	28	29	30	31	32	33	34	35	36	37	38	39	40	41
HRc	21	22	23	24	25	26	27	28	29	30	31	32	33	34	35	36	37	38	39	40	41
HB	60	100	75	90	130	110	90	100			200	280	250	350	320	400 Rm	1050 Rm	550	630	400	550
Recommend	○	○	○	○	○	○	○	○	○	○	○	○	○	○	○	○	○	○	○	○	○



PLAIN SHANK **G9400 SERIES**



RECOMMENDED CUTTING CONDITIONS
EMPFOLHENE SCHNEIDPARAMETER

G9624, G9A70, G9437, G9438, G9454, G9455 SERIES 2 FLUTE BALL NOSE

Vc = m/min.
fz = mm/tooth
RPM = rev./min.
FEED = mm/min.
Ap = mm

CARBIDE, 2 FLUTE DRILL MILLS
VOLLHARTMETALL, 2 SCHNEIDEN BOHRNUTEN FRÄSER
Fraise foret carbure, 2 dents, multi-fonctions
2 TAGLIENTI, FRESA IN MD A 90°



CARBIDE YG STD 30° DIN 6535HA TiAlN p.C580-582

Flat Shank	Page	Plain Shank	Page
END MILL HOLDER	D118-137	HYDRAULIC CHUCK	D15-46
		POWER MILLING CHUCK	D161-176
		SHRINK FIT HOLDER	D47-72
		ER COLLET CHUCK	D73-118
		SK SLIM CHUCK	D183-201

Recommended Tool Holder

EDP No.	Mill Diameter	Shank Diameter	Length of Cut	Overall Length
G9400030	3.0	4	6	50
G9400040	4.0	5	8	50
G9400050	5.0	6	10	50
G9400060	6.0	8	12	60
G9400080	8.0	10	16	70
G9400100	10.0	12	18	70
G9400120	12.0	12	20	70
G9400140	14.0	14	24	80
G9400160	16.0	16	26	80
G9400200	20.0	20	32	100

- ▶ TiN, TiCN and TiAlN Coatings are available on your request.
- Performs many drilling and milling operations that are not presently done with the standard end mill.
- Among the many vertical milling machine operations, applications for the Drill Mill are: Drilling, Slotting, NC Milling, Drilling & Slotting, Profile Milling and Chamfering.

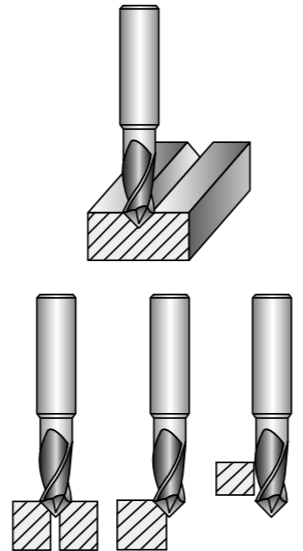
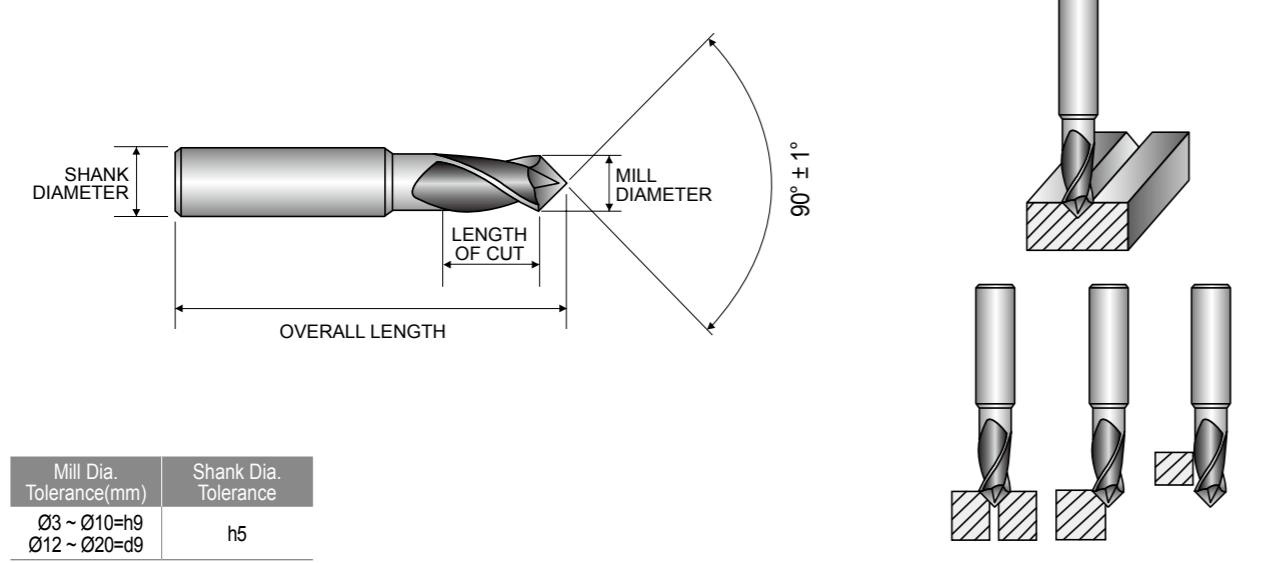

◎: Excellent ○: Good

ISO	P									M				K						
	Non-alloy steel				Low alloy steel					High alloyed steel, and tool steel		Stainless steel		Grey cast iron	Nodular cast iron	Malleable cast iron				
Material Description	1	2	3	4	5	6	7	8	9	10	11	12	13	14	15	16	17	18	19	20
VDI 3323	1	2	3	4	5	6	7	8	9	10	11	12	13	14	15	16	17	18	19	20
HRc																				
HB	125	190	250	270	300	180	275	300	350	200	325	200	240	180	180	260	160	250	130	230
Recommend	◎	◎	◎	◎	◎	◎	◎	◎	◎	◎	◎	○	○	○	○	○	○	○	○	○

ISO	N							S						H							
	Aluminum-wrought alloy		Aluminum-cast, alloyed			Copper and Copper Alloys (Bronze / Brass)		Non Metallic Materials		Heat Resistant Super Alloys				Titanium Alloys		Hardened steel	Chilled Cast Iron	Hardened Cast Iron			
Material Description	21	22	23	24	25	26	27	28	29	30	31	32	33	34	35	36	37	38	39	40	41
VDI 3323	21	22	23	24	25	26	27	28	29	30	31	32	33	34	35	36	37	38	39	40	41
HRc																					
HB	60	100	75	90	130	110	90	100			200	280	250	350	320	400 Rm	1050 Rm	550	630	400	550
Recommend	○	○	○	○	○						○	○	○	○	○	○	○	○	○	○	○

ISO	VDI 3323	Material Description	Ae	Parameter	Mill Diameter (Ø)											
					2.0	3.0	4.0	5.0	6.0	8.0	10.0	12.0	14.0	16.0	18.0	20.0
P	1-4	Non-alloy steel	0.2D	Vc	80	105	110	125	135	155	170	190	200	205	215	225
				fz	0.026	0.025	0.035	0.045	0.06	0.089	0.122	0.15	0.165	0.18	0.188	0.201
	RPM	12732	11141	8754	7958	7162	6167	5411	5040	4547	4078	3802	3581			
	FEED	662	557	613	716	859	1098	1320	1512	1501	1468	1430	1440			
	Ap	0.2	0.2	0.2	0.2	0.2	0.3	0.3	0.3	0.3	0.3	0.3	0.3			
	5	Non-alloy steel	0.2D	Vc	55	80	90	95	110	125	135	150	160	160	170	175
				fz	0.023	0.023	0.031	0.04	0.06	0.08	0.1	0.12	0.128	0.141	0.148	0.158
	RPM	8754	8488	7162	6048	5836	4974	4297	3979	3638	3183	3006	2785			
	FEED	403	390	444	484	700	796	859	955	931	898	890	880			
	Ap	0.2	0.2	0.2	0.2	0.2	0.3	0.3	0.3	0.3	0.3	0.3	0.3			
	6-7	Low alloy steel	0.2D	Vc	80	105	110	125	135	155	170	190	200	205	215	225
				fz	0.026	0.025	0.035	0.045	0.06	0.089	0.122	0.15	0.165	0.18	0.188	0.201
RPM	12732	11141	8754	7958	7162	6167	5411	5040	4547	4078	3802	3581				
FEED	662	557	613	716	859	1098	1320	1512	1501	1468	1430	1440				
Ap	0.2	0.2	0.2	0.2	0.2	0.3	0.3	0.3	0.3	0.3	0.3	0.3				
8-9	Low alloy steel	0.2D	Vc	55	80	90	95	110	125	135	150	160	160	170	175	
			fz	0.023	0.023	0.031	0.04	0.06	0.08	0.1	0.12	0.128	0.141	0.148	0.158	
RPM	8754	8488	7162	6048	5836	4974	4297	3979	3638	3183	3006	2785				
FEED	403	390	444	484	700	796	859	955	931	898	890	880				
Ap	0.2	0.2	0.2	0.2	0.2	0.3	0.3	0.3	0.3	0.3	0.3	0.3				
10	High alloyed steel, and tool steel	0.2D	Vc	80	105	110	125	135	155	170	190	200	205	215	225	
			fz	0.026	0.025	0.035	0.045	0.06	0.089	0.122	0.15	0.165	0.18	0.188	0.201	
RPM	12732	11141	8754	7958	7162	6167	5411	5040	4547	4078	3802	3581				
FEED	662	557	613	716	859	1098	1320	1512	1501	1468	1430	1440				
Ap	0.2	0.2	0.2	0.2	0.2	0.3	0.3	0.3	0.3	0.3	0.3	0.3				
11.1-11.2	High alloyed steel, and tool steel	0.2D	Vc	55	80	90	95	110	125	135	150	160	160	170	175	
			fz	0.023	0.023	0.031	0.04	0.06	0.08	0.1	0.12	0.128	0.141	0.148	0.158	
RPM	8754	8488	7162	6048	5836	4974	4297	3979	3638	3183	3006	2785				
FEED	403	390	444	484	700	796	859	955	931	898	890	880				
Ap	0.2	0.2	0.2	0.2	0.2	0.3	0.3	0.3	0.3	0.3	0.3	0.3				
K	15-20	Grey cast iron Nodular cast iron Malleable cast iron	0.7D	Vc	65	65	65	65	65	65	65	65	60	65	60	65
				fz	0.01	0.016	0.028	0.04	0.053	0.092	0.112	0.131	0.164	0.177	0.209	0.2
				RPM	10345	6897	5173	4138	3448	2586	2069	1724	1364	1293	1061	1035
				FEED	207	221	290	331	366	476	463	452	447	458	444	414
Ap	0.3	0.3	0.3	0.3	0.3	0.3	0.3	0.3	0.3	0.3	0.3	0.3	0.3			
N	21~22	Aluminum-wrought alloy	0.7D	Vc	195	195	195	190	195	200	195	195	190	195	185	
				fz	0.006	0.01	0.013	0.019	0.023	0.034	0.044	0.061	0.073	0.07	0.079	0.092
	RPM	31035	20690	15518	12096	10345	7958	6207	5173	4320	3879	3360	2944			
	FEED	372	414	403	460	476	541	546	631	631	543	531	542			
Ap	0.3	0.3	0.3	0.3	0.3	0.3	0.3	0.3	0.3	0.3	0.3	0.3	0.3			
23~25	Aluminum-cast, alloyed	0.7D	Vc	195	195	195	190	195	200	195	195	190	195	185		
			fz	0.006	0.01	0.013	0.019	0.023	0.034	0.044	0.061	0.073	0.07	0.079	0.092	
RPM	31035	20690	15518	12096	10345	7958	6207	5173	4320	3879	3360	2944				
FEED	372	414	403	460	476	541	546	631	631	543	531	542				
Ap	0.3	0.3	0.3	0.3	0.3	0.3	0.3	0.3	0.3	0.3	0.3	0.3	0.3			
H	38.1	Hardened steel	0.2D	Vc	25	35	45	50	50	50	55	55	55	60	60	60
				fz	0.016	0.016	0.021	0.024	0.03	0.046	0.054	0.07	0.081	0.091	0.1	0.111
	RPM	3979	3714	3581	3183	2653	1989	1751	1459	1251	1194	1061	955			
	FEED	127	119	150	153	159	183	189	204	203	217	212	212			
Ap	0.2	0.2	0.2	0.2	0.2	0.3	0.3	0.3	0.3	0.3	0.3	0.3	0.3			
40	Chilled Cast Iron	0.2D	Vc	55	80	90	95	110	125	135	150	160	160	170	175	
			fz	0.023	0.023	0.031	0.04	0.06	0.08	0.1	0.12	0.128	0.141	0.148	0.158	
RPM	8754	8488	7162	6048	5836	4974	4297	3979	3638	3183	3006	2785				
FEED	403	390	444	484	700	796	859	955	931	898	890	880				
Ap	0.2	0.2	0.2	0.2	0.2	0.3	0.3	0.3	0.3	0.3	0.3	0.3	0.3			

※ The FEED, in long & extra long types, should be reduced by around 50%

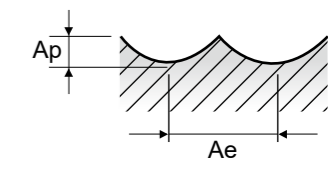



RECOMMENDED CUTTING CONDITIONS
EMPFOHLENE SCHNEIDPARAMETER



RECOMMENDED CUTTING CONDITIONS
EMPFOHLENE SCHNEIDPARAMETER

G9B81 SERIES 2 FLUTE BALL NOSE

G9B81 SERIES 2 FLUTE BALL NOSE

Vc = m/min.
fz = mm/tooth
RPM = rev./min.
FEED = mm/min.
Ap = mm

Vc = m/min.
fz = mm/tooth
RPM = rev./min.
FEED = mm/min.
Ap = mm

Table with columns for ISO, VDI 3323, Material Description, Parameter, and Mill Diameter (Ø) ranging from 0.4 to 1.0. Rows include parameters Vc, fz, RPM, FEED, and Ap for different material groups like Non-alloy steel, Low alloy steel, and High alloyed steel.

Table with columns for VDI 3323, Parameter, and Mill Diameter (Ø) ranging from 1.2 to 4.0. Rows include parameters Vc, fz, RPM, FEED, and Ap for different material groups like Non-alloy steel, Low alloy steel, and High alloyed steel.

※ The FEED, in long & extra long types, should be reduced by around 50%

※ The FEED, in long & extra long types, should be reduced by around 50%

▶ NEXT PAGE

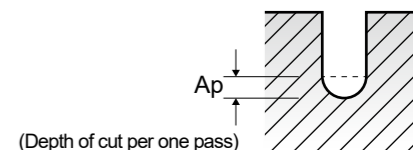
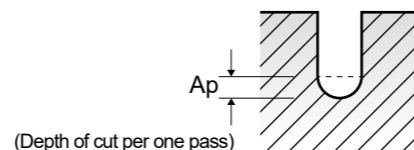



RECOMMENDED CUTTING CONDITIONS
EMPFOHLENE SCHNEIDPARAMETER

G9B84, G9B85 SERIES 4 FLUTE CORNER RADIUS - SIDE CUTTING

Vc = m/min.
fz = mm/tooth
RPM = rev./min.
FEED = mm/min.

Table with columns: ISO, VDI 3323, Material Description, Ae, Ap, Parameter, Mill Diameter (Ø) [1.0, 1.5, 2.0, 3.0, 4.0, 5.0, 6.0, 8.0, 10.0, 12.0], Vc, fz, RPM, FEED. Rows include Non-alloy steel, Low alloy steel, High alloyed steel, Stainless steel, Grey cast iron, Aluminum-wrought alloy, Aluminum-cast alloyed, Copper and Copper Alloys, Non Metallic Materials, Chilled Cast Iron.

※ The FEED, in long & extra long types, should be reduced by around 50%

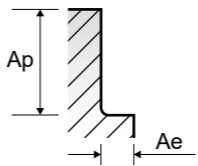

RECOMMENDED CUTTING CONDITIONS
EMPFOHLENE SCHNEIDPARAMETER

G9424, G9G44, G9A68, G9444, G9527, G9445, G9G45, G9452 SERIES 2 FLUTE - SLOTTING

Vc = m/min.
fz = mm/tooth
RPM = rev./min.
FEED = mm/min.

Table with columns: ISO, VDI 3323, Material Description, Ae, Ap, Parameter, Mill Diameter (Ø) [1.0, 1.5, 2.0, 3.0, 4.0, 5.0, 6.0, 8.0, 10.0, 12.0, 14.0, 16.0, 20.0], Vc, fz, RPM, FEED. Rows include Non-alloy steel, Low alloy steel, High alloyed steel, Stainless steel, Grey cast iron, Aluminum-wrought alloy, Aluminum-cast alloyed, Copper and Copper Alloys, Non Metallic Materials, Chilled Cast Iron.

※ The FEED, in long & extra long types, should be reduced by around 50%

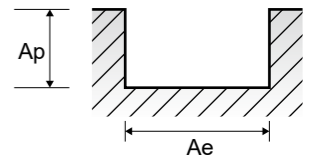

G9B80 SERIES 2 FLUTE - **SLOTING**

Vc = m/min.
fz = mm/tooth
RPM = rev./min.
FEED = mm/min.
Ap = mm

ISO	VDI 3323	Material Description	Parameter	Mill Diameter (Ø)						
				0.4	0.5	0.6	0.7	0.8	0.9	1.0
P	1-4	Non-alloy steel	Vc	33~43	42~53	50~64	58~75	58~75	61~76	60~75
			fz	0.003~0.005	0.003~0.005	0.004~0.007	0.004~0.007	0.005~0.009	0.006~0.011	0.006~0.014
			RPM	26500~34000	26500~34000	26500~34000	26500~34000	23000~30000	21500~27000	19000~24000
			FEED	170~370	170~370	210~485	210~485	240~535	240~610	240~690
			Ap	0.007~0.018	0.009~0.022	0.011~0.026	0.012~0.031	0.014~0.035	0.030~0.060	0.045~0.090
			Vc	24~30	30~38	36~45	42~53	41~53	42~54	42~53
	5	Non-alloy steel	fz	0.002~0.006	0.002~0.006	0.003~0.008	0.003~0.008	0.003~0.010	0.005~0.012	0.006~0.015
			RPM	19000~24000	19000~24000	19000~24000	19000~24000	16500~21000	15000~19000	13500~17000
			FEED	72~290	72~290	95~365	95~365	100~410	135~460	160~510
			Ap	0.007~0.018	0.009~0.022	0.011~0.026	0.012~0.031	0.014~0.035	0.030~0.060	0.045~0.090
			Vc	33~43	42~53	50~64	58~75	58~75	61~76	60~75
			fz	0.003~0.005	0.003~0.005	0.004~0.007	0.004~0.007	0.005~0.009	0.006~0.011	0.006~0.014
	6-7	Low alloy steel	RPM	26500~34000	26500~34000	26500~34000	26500~34000	23000~30000	21500~27000	19000~24000
			FEED	170~370	170~370	210~485	210~485	240~535	240~610	240~690
			Ap	0.007~0.018	0.009~0.022	0.011~0.026	0.012~0.031	0.014~0.035	0.030~0.060	0.045~0.090
			Vc	24~30	30~38	36~45	42~53	41~53	42~54	42~53
			fz	0.002~0.006	0.002~0.006	0.003~0.008	0.003~0.008	0.003~0.010	0.005~0.012	0.006~0.015
			RPM	19000~24000	19000~24000	19000~24000	19000~24000	16500~21000	15000~19000	13500~17000
8-9	Low alloy steel	FEED	72~290	72~290	95~365	95~365	100~410	135~460	160~510	
		Ap	0.007~0.018	0.009~0.022	0.011~0.026	0.012~0.031	0.014~0.035	0.030~0.060	0.045~0.090	
		Vc	33~43	42~53	50~64	58~75	58~75	61~76	60~75	
		fz	0.003~0.005	0.003~0.005	0.004~0.007	0.004~0.007	0.005~0.009	0.006~0.011	0.006~0.014	
		RPM	26500~34000	26500~34000	26500~34000	26500~34000	23000~30000	21500~27000	19000~24000	
		FEED	170~370	170~370	210~485	210~485	240~535	240~610	240~690	
10	High alloyed steel, and tool steel	Ap	0.007~0.018	0.009~0.022	0.011~0.026	0.012~0.031	0.014~0.035	0.030~0.060	0.045~0.090	
		Vc	24~30	30~38	36~45	42~53	41~53	42~54	42~53	
		fz	0.002~0.006	0.002~0.006	0.003~0.008	0.003~0.008	0.003~0.010	0.005~0.012	0.006~0.015	
		RPM	19000~24000	19000~24000	19000~24000	19000~24000	16500~21000	15000~19000	13500~17000	
		FEED	72~290	72~290	95~365	95~365	100~410	135~460	160~510	
		Ap	0.007~0.018	0.009~0.022	0.011~0.026	0.012~0.031	0.014~0.035	0.030~0.060	0.045~0.090	
11.1 - 11.2	High alloyed steel, and tool steel	Vc	24~30	30~38	36~45	42~53	41~53	42~54	42~53	
		fz	0.002~0.006	0.002~0.006	0.003~0.008	0.003~0.008	0.003~0.010	0.005~0.012	0.006~0.015	
		RPM	19000~24000	19000~24000	19000~24000	19000~24000	16500~21000	15000~19000	13500~17000	

※ The FEED, in long & extra long types, should be reduced by around 50%

▶ NEXT PAGE

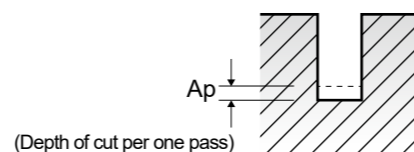

G9B80 SERIES 2 FLUTE - **SLOTING**

Vc = m/min.
fz = mm/tooth
RPM = rev./min.
FEED = mm/min.
Ap = mm

VDI 3323	Parameter	Mill Diameter (Ø)								
		1.2	1.4	1.5	1.6	1.8	2.0	2.5	3.0	4.0
1-4	Vc	58~72	60~75	59~73	60~75	62~79	63~79	63~79	64~80	64~82
	fz	0.008~0.020	0.009~0.023	0.010~0.025	0.010~0.026	0.011~0.027	0.012~0.031	0.015~0.038	0.018~0.045	0.024~0.059
	RPM	15500~19000	13600~17000	12500~15500	12000~15000	11000~14000	10000~12500	8000~10000	6800~8500	5100~6500
5	FEED	240~765	240~765	240~765	240~765	240~765	240~765	240~765	240~765	240~765
	Ap	0.055~0.100	0.062~0.125	0.070~0.135	0.075~0.145	0.080~0.160	0.090~0.180	0.112~0.235	0.135~0.270	0.180~0.360
	Vc	41~53	43~53	42~54	44~55	44~55	44~56	45~57	44~57	44~57
6-7	fz	0.007~0.018	0.008~0.021	0.009~0.022	0.009~0.023	0.010~0.026	0.011~0.028	0.014~0.035	0.017~0.043	0.023~0.057
	RPM	11000~14000	9800~12000	8950~11500	8700~10900	7800~9800	7000~8950	5700~7200	4700~6000	3500~4500
	FEED	160~510	160~510	160~510	160~510	160~510	160~510	160~510	160~510	160~510
8-9	Ap	0.055~0.100	0.062~0.125	0.070~0.135	0.075~0.145	0.080~0.160	0.090~0.180	0.112~0.235	0.135~0.270	0.180~0.360
	Vc	58~72	60~75	59~73	60~75	62~79	63~79	63~79	64~80	64~82
	fz	0.008~0.020	0.009~0.023	0.010~0.025	0.010~0.026	0.011~0.027	0.012~0.031	0.015~0.038	0.018~0.045	0.024~0.059
10	RPM	15500~19000	13600~17000	12500~15500	12000~15000	11000~14000	10000~12500	8000~10000	6800~8500	5100~6500
	FEED	240~765	240~765	240~765	240~765	240~765	240~765	240~765	240~765	240~765
	Ap	0.055~0.100	0.062~0.125	0.070~0.135	0.075~0.145	0.080~0.160	0.090~0.180	0.112~0.235	0.135~0.270	0.180~0.360
11.1 - 11.2	Vc	41~53	43~53	42~54	44~55	44~55	44~56	45~57	44~57	44~57
	fz	0.007~0.018	0.008~0.021	0.009~0.022	0.009~0.023	0.010~0.026	0.011~0.028	0.014~0.035	0.017~0.043	0.023~0.057
	RPM	11000~14000	9800~12000	8950~11500	8700~10900	7800~9800	7000~8950	5700~7200	4700~6000	3500~4500

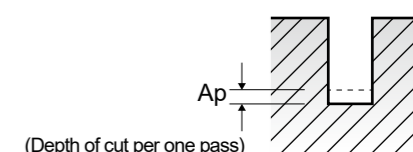

RECOMMENDED CUTTING CONDITIONS EMPFOHLENE SCHNEIDPARAMETER

G9553, G9G46, G9410, G9425, G9G47, G9439 G9528, G9433, G9G48, G9447, G9G49 SERIES

3 FLUTE - SLOTTING

Vc = m/min. fz = mm/tooth RPM = rev./min. FEED = mm/min.

Table with columns for ISO, VDI 3323, Material Description, Ae, Ap, Parameter, and Mill Diameter (Ø) ranging from 1.0 to 20.0. Rows include Non-alloy steel, Low alloy steel, High alloyed steel, Stainless steel, Grey cast iron, Aluminum-wrought alloy, Aluminum-cast alloyed, Copper and Copper Alloys, Non Metallic Materials, and Chilled Cast Iron.

※ The FEED, in long & extra long types, should be reduced by around 50%

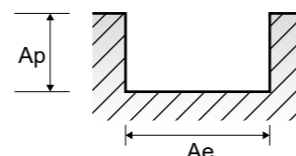

RECOMMENDED CUTTING CONDITIONS EMPFOHLENE SCHNEIDPARAMETER

G9553, G9G46, G9410, G9425, G9G47, G9439 G9528, G9433, G9G48, G9447, G9G49 SERIES

3 FLUTE - SIDE CUTTING

Vc = m/min. fz = mm/tooth RPM = rev./min. FEED = mm/min.

Table with columns for ISO, VDI 3323, Material Description, Ae, Ap, Parameter, and Mill Diameter (Ø) ranging from 1.0 to 20.0. Rows include Non-alloy steel, Low alloy steel, High alloyed steel, Stainless steel, Grey cast iron, Aluminum-wrought alloy, Aluminum-cast alloyed, Copper and Copper Alloys, Non Metallic Materials, and Chilled Cast Iron.

※ The FEED, in long & extra long types, should be reduced by around 50%

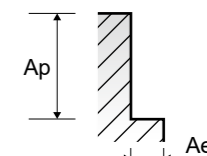



RECOMMENDED CUTTING CONDITIONS
EMPFOHLENE SCHNEIDPARAMETER



RECOMMENDED CUTTING CONDITIONS
EMPFOHLENE SCHNEIDPARAMETER

G9432, G9G50, G9A69, G9448, G9540, G9449, G9G51, G9453 SERIES **4 FLUTE - SIDE CUTTING**

G9H73, G9H74, G9H75, G9H76 SERIES **4 FLUTE MULTIFLUX HELIX**

Vc = m/min.
fz = mm/tooth
RPM = rev/min.
FEED = mm/min.

ISO	VDI 3323	Material Description	Ae	Ap	Parameter	Mill Diameter (Ø)															
						1.0	1.5	2.0	3.0	4.0	5.0	6.0	8.0	10.0	12.0	14.0	16.0	20.0			
P	1-4	Non-alloy steel	0.1D	1.0D	Vc	55	55	60	70	80	85	90	90	85	90	90	95	90			
					fz	0.002	0.005	0.006	0.009	0.019	0.024	0.029	0.043	0.047	0.047	0.047	0.047	0.047	0.047	0.047	
	5	Non-alloy steel	0.1D	1.0D	Vc	30	35	40	45	50	50	55	55	55	55	60	55				
					fz	0.002	0.004	0.006	0.009	0.019	0.024	0.031	0.038	0.038	0.037	0.038	0.037	0.038	0.038		
	6-7	Low alloy steel	0.1D	1.0D	Vc	55	55	60	70	80	85	90	90	85	90	90	95	90			
					fz	0.002	0.005	0.006	0.009	0.019	0.024	0.029	0.043	0.047	0.047	0.047	0.047	0.047	0.047	0.047	
	8-9	Low alloy steel	0.1D	1.0D	Vc	30	35	40	45	50	50	55	55	55	55	60	55				
					fz	0.002	0.004	0.006	0.009	0.019	0.024	0.031	0.038	0.038	0.037	0.038	0.037	0.038	0.038		
	10	High alloyed steel, and tool steel	0.1D	1.0D	Vc	55	55	60	70	80	85	90	90	85	90	90	95	90			
					fz	0.002	0.005	0.006	0.009	0.019	0.024	0.029	0.043	0.047	0.047	0.047	0.047	0.047	0.047	0.047	
	11.1 - 11.2	High alloyed steel, and tool steel	0.1D	1.0D	Vc	30	35	40	45	50	50	55	55	55	55	60	55				
					fz	0.002	0.004	0.006	0.009	0.019	0.024	0.031	0.038	0.038	0.037	0.038	0.037	0.038	0.038		
M	14.1	Stainless steel	0.1D	1.0D	Vc	25	35	35	35	40	45	45	45	45	45	50	45				
					fz	0.002	0.004	0.006	0.009	0.018	0.024	0.029	0.042	0.044	0.045	0.045	0.045	0.045	0.046		
K	15-20	Grey cast iron, Nodular cast iron, Malleable cast iron	0.1D	1.5D	Vc	60	55	60	55	60	55	55	55	60	55	55	55				
					fz	0.008	0.013	0.017	0.026	0.035	0.044	0.065	0.093	0.116	0.155	0.182	0.22	0.288			
N	21~22	Aluminum-wrought alloy	0.1D	1.5D	Vc	140	130	140	145	140	145	145	145	145	140	145	145	140			
					fz	0.006	0.011	0.015	0.021	0.03	0.036	0.047	0.063	0.078	0.095	0.108	0.125	0.163			
	23~25	Aluminum-cast, alloyed	0.1D	1.5D	Vc	140	130	140	145	140	145	145	145	145	140	145	145	140			
					fz	0.006	0.011	0.015	0.021	0.03	0.036	0.047	0.063	0.078	0.095	0.108	0.125	0.163			
	26-28	Copper and Copper Alloys (Bronze / Brass)	0.1D	1.5D	Vc	80	95	105	105	110	105	105	110	105	105	110	105				
					fz	0.006	0.011	0.016	0.024	0.029	0.038	0.048	0.063	0.081	0.096	0.115	0.125	0.162			
	29.1	Non Metallic Materials	0.1D	1.5D	Vc	80	95	105	105	110	105	105	110	105	105	110	105				
					fz	0.006	0.011	0.016	0.024	0.029	0.038	0.048	0.063	0.081	0.096	0.115	0.125	0.162			
	H	40	Chilled Cast Iron	0.1D	1.0D	Vc	30	35	40	45	50	50	55	55	55	55	60	55			
						fz	0.002	0.004	0.006	0.009	0.019	0.024	0.031	0.038	0.038	0.037	0.038	0.037	0.038	0.038	

※ The FEED, in long & extra long types, should be reduced by around 50%

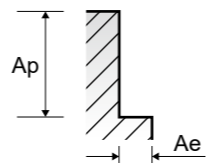

SIDE CUTTING **SLOTING**

ISO	VDI 3323	Material Description	Ae	Ap	Ae	Ap	Parameter	Mill Diameter (Ø)										
								3.0	4.0	5.0	6.0	8.0	10.0	12.0	16.0	20.0		
P	1-4	Non-alloy steel	0.3D	1.5D (1.2D)	0.3D	1.5D (1.2D)	Vc	106	106	106	106	106	118	118	118	118		
							fz	0.005	0.008	0.011	0.016	0.027	0.038	0.047	0.053	0.065		
	5	Non-alloy steel	0.3D	1.5D (1.2D)	0.3D	1.5D (1.2D)	Vc	75	75	75	75	75	82	82	82	82		
							fz	0.005	0.008	0.011	0.016	0.027	0.038	0.047	0.053	0.065		
	6-7	Low alloy steel	0.3D	1.5D (1.2D)	0.3D	1.5D (1.2D)	Vc	106	106	106	106	106	118	118	118	118		
							fz	0.005	0.008	0.011	0.016	0.027	0.038	0.047	0.053	0.065		
	8-9	Low alloy steel	0.3D	1.5D (1.2D)	0.3D	1.5D (1.2D)	Vc	75	75	75	75	75	82	82	82	82		
							fz	0.005	0.008	0.011	0.016	0.027	0.038	0.047	0.053	0.065		
	10-11.1	High alloyed steel, and tool steel	0.3D	1.5D (1.2D)	0.3D	1.5D (1.2D)	Vc	45	45	45	45	45	49	49	49	49		
							fz	0.003	0.006	0.008	0.011	0.019	0.027	0.032	0.037	0.045		
	M	14.1	Stainless steel	0.3D	1.5D (1.2D)	0.3D	1.5D (1.2D)	Vc	104	104	104	104	104	104	104	104	104	
								fz	0.004	0.006	0.009	0.013	0.022	0.034	0.039	0.045	0.055	
K	15-20	Grey cast iron, Nodular cast iron, Malleable cast iron	0.3D	1.5D (1.2D)	0.3D	1.5D (1.2D)	Vc	74	74	74	74	74	74	74	74	74		
							fz	0.005	0.008	0.013	0.018	0.028	0.048	0.055	0.062	0.077		

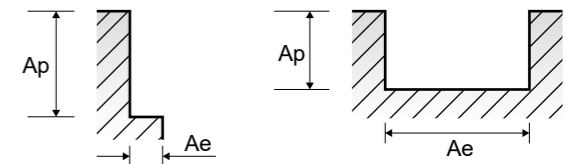

RECOMMENDED CUTTING CONDITIONS EMPFOHLENE SCHNEIDPARAMETER

RECOMMENDED CUTTING CONDITIONS EMPFOHLENE SCHNEIDPARAMETER

G9F45, G9F46 SERIES

4&6 FLUTE - SIDE CUTTING

Vc = m/min.
fz = mm/tooth
RPM = rev./min.
FEED = mm/min.

ISO	VDI 3323	Material Description	Ae	Ap	Parameter	Mill Diameter (Ø)										
						3.0	4.0	5.0	6.0	8.0	10.0	12.0	14.0	16.0	18.0	20.0
P	1-4	Non-alloy steel	0.05D	1.5D	Vc	82	83	98	98	97	97	99	98	98	97	97
					fz	0.024	0.033	0.025	0.03	0.045	0.045	0.053	0.058	0.062	0.065	0.069
	RPM	8700	6605	6239	5199	3860	3088	2626	2228	1950	1715	1544				
	FEED	835	872	936	936	1042	834	835	775	725	669	639				
	5	Non-alloy steel	0.03D	1.5D	Vc	54	55	65	65	65	64	66	66	65	65	64
					fz	0.024	0.033	0.027	0.03	0.038	0.045	0.053	0.057	0.062	0.066	0.07
	RPM	5730	4377	4138	3448	2586	2037	1751	1501	1293	1149	1019				
	FEED	550	578	670	621	590	550	557	513	481	455	428				
	6-7	Low alloy steel	0.05D	1.5D	Vc	82	83	98	98	97	97	99	98	98	97	97
					fz	0.024	0.033	0.025	0.03	0.045	0.045	0.053	0.058	0.062	0.065	0.069
	RPM	8700	6605	6239	5199	3860	3088	2626	2228	1950	1715	1544				
	FEED	835	872	936	936	1042	834	835	775	725	669	639				
8-9	Low alloy steel	0.03D	1.5D	Vc	54	55	65	65	65	64	66	66	65	65	64	
				fz	0.024	0.033	0.027	0.03	0.038	0.045	0.053	0.057	0.062	0.066	0.07	
RPM	5730	4377	4138	3448	2586	2037	1751	1501	1293	1149	1019					
FEED	550	578	670	621	590	550	557	513	481	455	428					
10	High alloyed steel, and tool steel	0.05D	1.5D	Vc	82	83	98	98	97	97	99	98	98	97	97	
				fz	0.024	0.033	0.025	0.03	0.045	0.045	0.053	0.058	0.062	0.065	0.069	
RPM	8700	6605	6239	5199	3860	3088	2626	2228	1950	1715	1544					
FEED	835	872	936	936	1042	834	835	775	725	669	639					
11.1 - 11.2	High alloyed steel, and tool steel	0.03D	1.5D	Vc	54	55	65	65	65	64	66	66	65	65	64	
				fz	0.024	0.033	0.027	0.03	0.038	0.045	0.053	0.057	0.062	0.066	0.07	
RPM	5730	4377	4138	3448	2586	2037	1751	1501	1293	1149	1019					
FEED	550	578	670	621	590	550	557	513	481	455	428					
K	15-20	Grey cast iron Nodular cast iron Malleable cast iron	0.05D	1.5D	Vc	82	83	98	98	97	97	99	98	98	97	97
					fz	0.024	0.033	0.025	0.03	0.045	0.045	0.053	0.058	0.062	0.065	0.069
					RPM	8700	6605	6239	5199	3860	3088	2626	2228	1950	1715	1544
					FEED	835	872	936	936	1042	834	835	775	725	669	639
H	38.1	Hardened steel	0.03D	1.5D	Vc	54	55	65	65	65	64	66	66	65	65	64
					fz	0.024	0.033	0.027	0.03	0.038	0.045	0.053	0.057	0.062	0.066	0.07
	RPM	5730	4377	4138	3448	2586	2037	1751	1501	1293	1149	1019				
	FEED	550	578	670	621	590	550	557	513	481	455	428				
	38.2 - 39.1	Hardened steel	0.03D	1.5D	Vc	45	45	50	50	50	50	50	50	50	50	50
					fz	0.018	0.025	0.02	0.023	0.029	0.033	0.029	0.041	0.046	0.05	0.052
	RPM	4775	3581	3183	2653	1989	1592	1326	1137	995	884	796				
	FEED	344	358	382	366	346	315	231	280	275	265	248				
	39.2	Hardened steel	0.02D	1D	Vc	35	35	40	40	40	40	40	40	40	41	
					fz	0.014	0.02	0.016	0.018	0.023	0.027	0.031	0.034	0.037	0.039	0.042
	RPM	3714	2785	2546	2122	1592	1273	1061	909	796	707	653				
	FEED	208	223	244	229	220	206	197	186	177	166	164				
40	Chilled Cast Iron	0.03D	1.5D	Vc	54	55	65	65	65	64	66	66	65	65	64	
				fz	0.024	0.033	0.027	0.03	0.038	0.045	0.053	0.057	0.062	0.066	0.07	
RPM	5730	4377	4138	3448	2586	2037	1751	1501	1293	1149	1019					
FEED	550	578	670	621	590	550	557	513	481	455	428					
41	Hardened Cast Iron	0.03D	1.5D	Vc	45	45	50	50	50	50	50	50	50	50	50	
				fz	0.018	0.025	0.02	0.023	0.029	0.033	0.029	0.041	0.046	0.05	0.052	
RPM	4775	3581	3183	2653	1989	1592	1326	1137	995	884	796					
FEED	344	358	382	366	346	315	231	280	275	265	248					

※ The FEED, in long & extra long types, should be reduced by around 50%

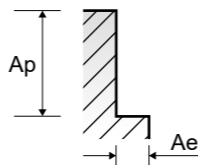

G9A42 SERIES

MULTI FLUTE ROUGHING - SIDE CUTTING

Vc = m/min.
fz = mm/tooth
RPM = rev./min.
FEED = mm/min.

ISO	VDI 3323	Material Description	Ae	Ap	Parameter	Mill Diameter (Ø)								
						6.0	8.0	10.0	12.0	14.0	16.0	18.0	20.0	25.0
P	1-4	Non-alloy steel	0.3D	1.5D	Vc	250	250	245	255	255	255	250	260	285
					fz	0.05	0.067	0.063	0.075	0.088	0.1	0.112	0.112	0.1
	RPM	13263	9947	7799	6764	5798	5073	4421	4138	3629				
	FEED	1989	1999	1965	2029	2041	2029	1981	1854	1814				
	5	Non-alloy steel	0.3D	1.5D	Vc	200	195	205	190	195	205	210	190	210
					fz	0.022	0.023	0.028	0.033	0.04	0.04	0.041	0.039	0.039
	RPM	10610	7759	6525	5040	4434	4078	3714	3024	2674				
	FEED	700	535	731	665	709	653	609	472	521				
	6-7	Low alloy steel	0.3D	1.5D	Vc	250	250	245	255	255	255	250	260	285
					fz	0.05	0.067	0.063	0.075	0.088	0.1	0.112	0.112	0.1
	RPM	13263	9947	7799	6764	5798	5073	4421	4138	3629				
	FEED	1989	1999	1965	2029	2041	2029	1981	1854	1814				
8-9	Low alloy steel	0.3D	1.5D	Vc	200	195	205	190	195	205	210	190	210	
				fz	0.022	0.023	0.028	0.033	0.04	0.04	0.041	0.039	0.039	
RPM	10610	7759	6525	5040	4434	4078	3714	3024	2674					
FEED	700	535	731	665	709	653	609	472	521					
10	High alloyed steel, and tool steel	0.3D	1.5D	Vc	250	250	245	255	255	255	250	260	285	
				fz	0.05	0.067	0.063	0.075	0.088	0.1	0.112	0.112	0.1	
RPM	13263	9947	7799	6764	5798	5073	4421	4138	3629					
FEED	1989	1999	1965	2029	2041	2029	1981	1854	1814					
11.1 - 11.2	High alloyed steel, and tool steel	0.3D	1.5D	Vc	200	195	205	190	195	205	210	190	210	
				fz	0.022	0.023	0.028	0.033	0.04	0.04	0.041	0.039	0.039	
RPM	10610	7759	6525	5040	4434	4078	3714	3024	2674					
FEED	700	535	731	665	709	653	609	472	521					
M	14.1	Stainless steel	0.05D	1.0D	Vc	135	135	135	135	135	140	130	145	
					fz	0.022	0.022	0.028	0.034	0.039	0.038	0.039	0.038	0.038
RPM	7162	5371	4297	3581	3069	2785	2299	2069	1846					
FEED	473	355	481	487	479	423	359	314	351					
S	31-35	Heat Resistant Super Alloys	0.05D	1.0D	Vc	40	40	35	40	35	35	35	35	40
					fz	0.026	0.024	0.036	0.04	0.037	0.032	0.038	0.041	0.06
RPM	2122	1592	1114	1061	796	619	557	509						
FEED	166	115	160	170	118	89	94	91	153					
H	40	Chilled Cast Iron	0.3D	1.5D	Vc	200	195	205	190	195	205	210	190	210
					fz	0.022	0.023	0.028	0.033	0.04	0.04	0.041	0.039	0.039
RPM	10610	7759	6525	5040	4434	4078	3714	3024	2674					
FEED	700	535	731	665	709	653	609	472	521					

※ The FEED, in long & extra long types, should be reduced by around 50%

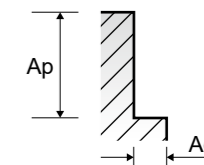

HSS

HSS



RECOMMENDED CUTTING CONDITIONS EMPFOHLENE SCHNEIDPARAMETER

RECOMMENDED CUTTING CONDITIONS EMPFOHLENE SCHNEIDPARAMETER

G9400 SERIES 2 FLUTE DRILL MILLS - CHAMFERING

G9400 SERIES 2 FLUTE DRILL MILLS - CHAMFERING & SIDE CUTTING

Vc = m/min. fz = mm/tooth RPM = rev./min. FEED = mm/min.

Vc = m/min. fz = mm/tooth RPM = rev./min. FEED = mm/min.

Table with columns: ISO, VDI 3323, Material Description, Parameter, Mill Diameter (Ø) [3.0, 4.0, 5.0, 6.0, 8.0, 10.0, 12.0, 16.0, 20.0]. Rows include P (Non-alloy steel, Low alloy steel, High alloyed steel, tool steel), M (Stainless steel), and N (Aluminum-wrought alloy, Aluminum-cast, alloyed).

Table with columns: ISO, VDI 3323, Material Description, Parameter, Mill Diameter (Ø) [3.0, 4.0, 5.0, 6.0, 8.0, 10.0, 12.0, 16.0, 20.0]. Rows include P (Non-alloy steel, Low alloy steel, High alloyed steel, tool steel), M (Stainless steel), N (Aluminum-wrought alloy, Aluminum-cast, alloyed), and S (Titanium Alloys).

※ The FEED, in long & extra long types, should be reduced by around 50%

※ The FEED, in long & extra long types, should be reduced by around 50%

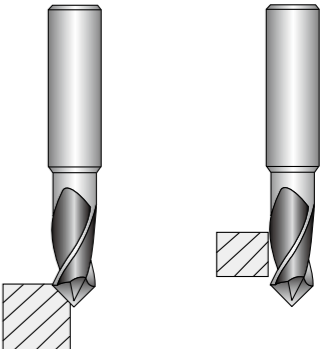
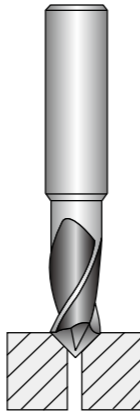

G9400 SERIES

2 FLUTE DRILL MILLS - V-GROOVING

Vc = m/min.
fz = mm/tooth
RPM = rev./min.
FEED = mm/min.

ISO	VDI 3323	Material Description	Parameter	Mill Diameter (Ø)								
				3.0	4.0	5.0	6.0	8.0	10.0	12.0	16.0	20.0
P	1-2	Non-alloy steel	Vc	80	85	85	80	80	90	95	100	95
			fz	0.005	0.006	0.008	0.01	0.014	0.016	0.018	0.023	0.029
			RPM	8488	6764	5411	4244	3183	2865	2520	1989	1512
	FEED		85	81	87	85	89	92	91	92	88	
	3-4		Vc	55	60	55	55	55	55	55	65	60
			fz	0.004	0.004	0.006	0.007	0.012	0.014	0.02	0.022	0.028
		RPM	5836	4775	3501	2918	2188	1751	1459	1293	955	
	5	Vc	45	50	50	50	45	55	55	55	55	
		fz	0.004	0.004	0.006	0.008	0.014	0.015	0.018	0.023	0.03	
		RPM	4775	3979	3183	2653	1790	1751	1459	1094	875	
	6	Vc	80	85	85	80	80	90	95	100	95	
		fz	0.005	0.006	0.008	0.01	0.014	0.016	0.018	0.023	0.029	
RPM		8488	6764	5411	4244	3183	2865	2520	1989	1512		
7	Vc	55	60	55	55	55	55	55	65	60		
	fz	0.004	0.004	0.006	0.007	0.012	0.014	0.02	0.022	0.028		
	RPM	5836	4775	3501	2918	2188	1751	1459	1293	955		
8-9	Vc	45	50	50	50	45	55	55	55	55		
	fz	0.004	0.004	0.006	0.008	0.014	0.015	0.018	0.023	0.03		
	RPM	4775	3979	3183	2653	1790	1751	1459	1094	875		
10	Vc	80	85	85	80	80	90	95	100	95		
	fz	0.005	0.006	0.008	0.01	0.014	0.016	0.018	0.023	0.029		
	RPM	8488	6764	5411	4244	3183	2865	2520	1989	1512		
11.1	Vc	45	50	50	50	45	55	55	55	55		
	fz	0.004	0.004	0.006	0.008	0.014	0.015	0.018	0.023	0.03		
	RPM	4775	3979	3183	2653	1790	1751	1459	1094	875		
M	14.1	Stainless steel	Vc	30	35	40	35	40	45	45	45	40
			fz	0.004	0.005	0.006	0.008	0.01	0.011	0.013	0.019	0.028
			RPM	3183	2785	2546	1857	1592	1432	1194	895	637
N	21~22	Aluminum-wrought alloy	Vc	185	210	210	205	205	220	230	230	230
			fz	0.008	0.01	0.013	0.016	0.022	0.026	0.03	0.041	0.052
			RPM	19629	16711	13369	10876	8157	7003	6101	4576	3661
S	36-37	Titanium Alloys	Vc	30	35	40	35	40	45	45	45	40
			fz	0.004	0.005	0.006	0.008	0.01	0.011	0.013	0.019	0.028
			RPM	3183	2785	2546	1857	1592	1432	1194	895	637

※ The FEED, in long & extra long types, should be reduced by around 50%

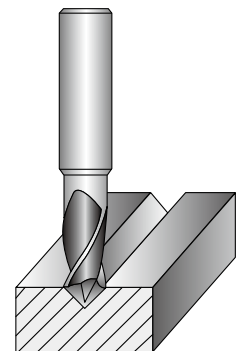



Leading Through Innovation



HSS PM60

ONLY ONE COATED PM60 END MILLS

Only One, beschichtete Pulvermetall PM60 Schaftfräser

- Perfect Solution of Carbide Chipping under Vibrations
- Perfekte Lösung bei Zerspanung unter Vibrationen

SELECTION GUIDE

HSS

HSS



COATED PM60

ONLY ONE END MILLS

Perfect solution to protect Carbide chipping problems under vibrations

Please visit globalyg1.com/mat for material search

◎ : Excellent ○ : Good

Recommended cutting conditions : p. C596

Table with 3 columns: SERIES, FLUTE, HELIX ANGLE, CUTTING EDGE SHAPE, SIZE MIN, SIZE MAX, PAGE. Rows include GYG77 GYF97, GYG72 GYF99, GYG01.



Main material selection table with columns: ISO, VDI 3323, Material Description, Composition / Structure / Heat Treatment, HB, HRc, and application suitability icons (◎/○).

Table with 7 columns: GYG74 GYF96, GYG52, GYG76 GYG02, GYF95, GYF94, GYF98, GYG03. Rows include FLUTE, HELIX ANGLE, CUTTING EDGE SHAPE, SIZE MIN, SIZE MAX, PAGE.



Material selection table for the second set of tools, with columns for ISO, VDI 3323, Material Description, Composition / Structure / Heat Treatment, HB, HRc, and application suitability icons.



PLAIN SHANK **GYG77** SERIES

FLAT SHANK **GYF97** SERIES

PM60, 2 FLUTE BALL NOSE SHORT LENGTH

- PM60, 2 Schneiden, Stirnradius kurz
- Revêtue YG-AICrN - PM60, 2 dents, série courte, hémisphérique
- Rivestita PM60, 2 TAGLIENTE SERIE CORTA SEMISFERICA

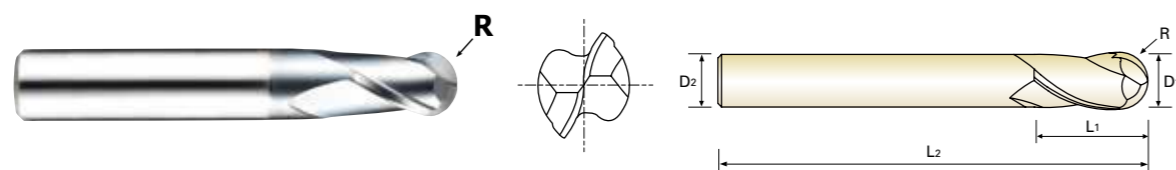

PM 60 2 30° ±0.02 PLAIN FLAT Coating Y p.C596

Flat Shank	Page	Plain Shank	Page
END MILL HOLDER	D118-137	POWER MILLING CHUCK	D161-176
		ER COLLET CHUCK	D73-116
		SK SLIM CHUCK	D183-201

Unit : mm

EDP No.		Radius of Ball Nose	Mill Diameter	Shank Diameter		Length of Cut	Overall Length
PLAIN	FLAT	R(±0.02)	D1	D2	D2	L1	L2
GYG77010	GYF97010	R0.5	1.0	6	6	2.5	47
GYG77020	GYF97020	R1.0	2.0	6	6	4	48
GYG77030	GYF97030	R1.5	3.0	6	6	5	49
GYG77040	GYF97040	R2.0	4.0	6	6	7	51
GYG77050	GYF97050	R2.5	5.0	6	6	8	52
GYG77060	GYF97060	R3.0	6.0	6	6	8	52
GYG77070	GYF97070	R3.5	7.0	8	8	10	60
GYG77080	GYF97080	R4.0	8.0	8	8	11	61
GYG77090	GYF97090	R4.5	9.0	10	10	11	61
GYG77100	GYF97100	R5.0	10.0	10	10	13	63
GYG77120	GYF97120	R6.0	12.0	12	12	16	73
GYG77140	GYF97140	R7.0	14.0	12	12	16	73
GYG77160	GYF97160	R8.0	16.0	16	16	19	79
GYG77180	GYF97180	R9.0	18.0	16	16	19	79
GYG77200	GYF97200	R10.0	20.0	20	20	22	88
GYG77250	GYF97250	R12.5	25.0	25	25	26	102

Mill Dia. Tolerance (mm)	Shank Dia. Tolerance
0 ~ -0.03	h6

◎ : Excellent ○ : Good

ISO Material Description	P									M						K					
	Non-alloy steel			Low alloy steel			High alloyed steel, and tool steel			Stainless steel			Grey cast iron		Nodular cast iron		Malleable cast iron				
VDI 3323	1	2	3	4	5	6	7	8	9	10	11	12	13	14	15	16	17	18	19	20	
HRc	13	25	28	32	38	10	29	32	38	15	35	15	23	10	10	26	3	25	21	21	
HB	125	190	250	270	300	180	275	300	350	200	325	200	240	180	180	260	160	250	130	230	
Recommend	◎	◎	◎	◎	◎	◎	◎	◎	◎	◎	◎	◎	◎	◎	◎	◎	◎	◎	◎	◎	◎



PLAIN SHANK **GYG72** SERIES

FLAT SHANK **GYF99** SERIES

PM60, 2 FLUTE SHORT LENGTH

- PM60, 2 Schneiden, kurz, Zentrumschnitt
- Revêtue YG-AICrN - PM60, 2 dents, série courte (Coupe au centre)
- Rivestita PM60, 2 TAGLIENTI SERIE CORTA (Tagliante al centro)

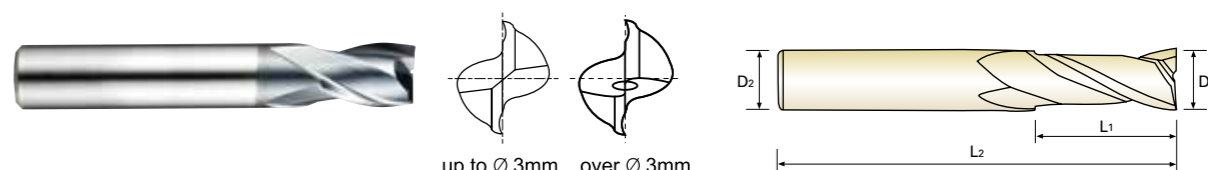

PM 60 2 30° PLAIN FLAT Coating Y p.C597

Flat Shank	Page	Plain Shank	Page
END MILL HOLDER	D118-137	POWER MILLING CHUCK	D161-176
		ER COLLET CHUCK	D73-116
		SK SLIM CHUCK	D183-201

Unit : mm

EDP No.		Mill Diameter	Shank Diameter	Length of Cut	Overall Length
PLAIN	FLAT	D1	D2	L1	L2
GYG72010	GYF99010	1.0	6	2.5	47
GYG72020	GYF99020	2.0	6	4	48
GYG72030	GYF99030	3.0	6	5	49
GYG72040	GYF99040	4.0	6	7	51
GYG72050	GYF99050	5.0	6	8	52
GYG72060	GYF99060	6.0	6	8	52
GYG72070	GYF99070	7.0	8	10	60
GYG72080	GYF99080	8.0	8	11	61
GYG72090	GYF99090	9.0	10	11	61
GYG72100	GYF99100	10.0	10	13	63
GYG72120	GYF99120	12.0	12	16	73
GYG72140	GYF99140	14.0	12	16	73
GYG72160	GYF99160	16.0	16	19	79
GYG72180	GYF99180	18.0	16	19	79
GYG72200	GYF99200	20.0	20	22	88
GYG72220	GYF99220	22.0	20	22	88
GYG72250	GYF99250	25.0	25	26	102

Mill Dia. Tolerance (mm)	Shank Dia. Tolerance
0 ~ -0.03	h6

◎ : Excellent ○ : Good

ISO Material Description	P									M						K					
	Non-alloy steel			Low alloy steel			High alloyed steel, and tool steel			Stainless steel			Grey cast iron		Nodular cast iron		Malleable cast iron				
VDI 3323	1	2	3	4	5	6	7	8	9	10	11	12	13	14	15	16	17	18	19	20	
HRc	13	25	28	32	38	10	29	32	38	15	35	15	23	10	10	26	3	25	21	21	
HB	125	190	250	270	300	180	275	300	350	200	325	200	240	180	180	260	160	250	130	230	
Recommend	◎	◎	◎	◎	◎	◎	◎	◎	◎	◎	◎	◎	◎	◎	◎	◎	◎	◎	◎	◎	◎



FLAT SHANK **GYG01** SERIES

PM60, 3 FLUTE SHORT LENGTH (Center Cut)

- PM60, 3 Schneiden, kurz, Zentrumschnitt
- Revêtue YG-AICrN - PM60, 3 dents, série courte (Coupe au centre)
- Rivestita PM60, 3 TAGLIENTI SERIE CORTA (Tagliante al centro)

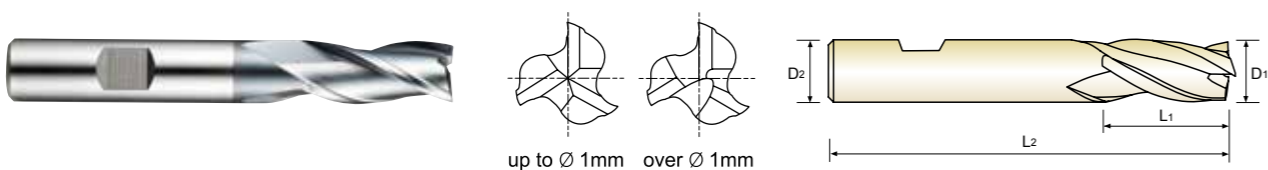

PM 60 3 30° FLAT Coating Y p.C598-599

Flat Shank	Page	Plain Shank	Page
END MILL HOLDER	D118-137	POWER MILLING CHUCK	D161-176
ER COLLET CHUCK	-	SK SLIM CHUCK	D73-116
SK SLIM CHUCK	-	ER COLLET CHUCK	D183-201

Unit : mm

EDP No.	Mill Diameter	Shank Diameter	Length of Cut	Overall Length
	D1	D2	L1	L2
GYG01010	1.0	6	3	47
GYG01020	2.0	6	7	51
GYG01030	3.0	6	8	52
GYG01040	4.0	6	11	55
GYG01050	5.0	6	13	57
GYG01060	6.0	6	13	57
GYG01070	7.0	8	16	66
GYG01080	8.0	8	19	69
GYG01090	9.0	10	19	69
GYG01100	10.0	10	22	72
GYG01120	12.0	12	26	83
GYG01140	14.0	12	26	83
GYG01160	16.0	16	32	92
GYG01180	18.0	16	32	92
GYG01200	20.0	20	38	104
GYG01220	22.0	20	38	104
GYG01250	25.0	25	45	121

Mill Dia. Tolerance (mm)	Shank Dia. Tolerance
0 ~ -0.03	h6

◎ : Excellent ○ : Good

ISO Material Description	P										M				K					
	Non-alloy steel					Low alloy steel					High alloyed steel, and tool steel				Stainless steel		Grey cast iron	Nodular cast iron		Malleable cast iron
VDI 3323	1	2	3	4	5	6	7	8	9	10	11	12	13	14	15	16	17	18	19	20
HRc	13	25	28	32	30	10	29	32	38	15	35	15	23	10	10	26	3	25	21	21
HB	125	190	250	270	300	180	275	300	350	200	325	200	240	180	180	260	160	250	130	230
Recommend	◎	◎	◎	◎	◎	◎	◎	◎	◎	◎	◎	◎	◎	◎	◎	◎	◎	◎	◎	◎

ISO Material Description	N					S					H										
	Aluminum-wrought alloy		Aluminum-cast, alloyed			Copper and Copper Alloys (Bronze / Brass)		Non Metallic Materials			Heat Resistant Super Alloys					Titanium Alloys		Hardened steel	Chilled Cast Iron	Hardened Cast Iron	
VDI 3323	21	22	23	24	25	26	27	28	29	30	31	32	33	34	35	36	37	38	39	40	41
HRc	21	22	23	24	25	26	27	28	29	30	15	30	25	38	34	55	60	42	55	42	55
HB	60	100	75	90	130	110	90	100			200	280	250	350	320	400 Rm	1050 Rm	550	630	400	550
Recommend						○	○	○													



PLAIN SHANK **GYG74** SERIES
FLAT SHANK **GYF96** SERIES

PM60, 4 FLUTE SHORT LENGTH (Center Cut)

- PM60, 4 Schneiden, kurz, Zentrumschnitt
- Revêtue YG-AICrN - PM60, 4 dents, série courte (Coupe au centre)
- Rivestita PM60, 4 TAGLIENTI SERIE CORTA (Tagliante al centro)

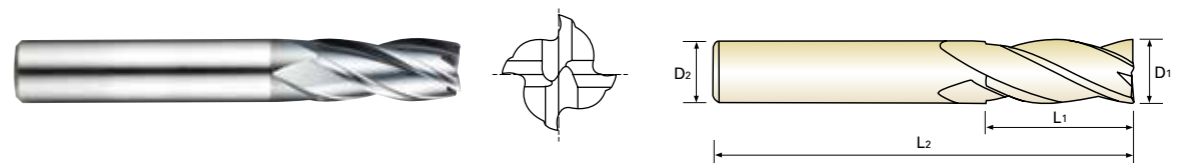

PM 60 4 30° PLAIN FLAT Coating Y p.C600

Flat Shank	Page	Plain Shank	Page
END MILL HOLDER	D118-137	POWER MILLING CHUCK	D161-176
ER COLLET CHUCK	-	SK SLIM CHUCK	D73-116
SK SLIM CHUCK	-	ER COLLET CHUCK	D183-201

Unit : mm

EDP No.	Mill Diameter	Shank Diameter	Length of Cut	Overall Length
	D1	D2	L1	L2
GYG74010	1.0	6	3	49
GYG74020	2.0	6	7	51
GYG74030	3.0	6	8	52
GYG74040	4.0	6	11	55
GYG74050	5.0	6	13	57
GYG74060	6.0	6	13	57
GYG74070	7.0	8	16	66
GYG74080	8.0	8	19	69
GYG74090	9.0	10	19	69
GYG74100	10.0	10	22	72
GYG74120	12.0	12	26	83
GYG74140	14.0	12	26	83
GYG74160	16.0	16	32	92
GYG74180	18.0	16	32	92
GYG74200	20.0	20	38	104
GYG74220	22.0	20	38	104
GYG74250	25.0	25	45	121

Mill Dia. Tolerance (mm)	Shank Dia. Tolerance
0 ~ -0.03	h6

◎ : Excellent ○ : Good

ISO Material Description	P										M				K					
	Non-alloy steel					Low alloy steel					High alloyed steel, and tool steel				Stainless steel		Grey cast iron	Nodular cast iron		Malleable cast iron
VDI 3323	1	2	3	4	5	6	7	8	9	10	11	12	13	14	15	16	17	18	19	20
HRc	13	25	28	32	30	10	29	32	38	15	35	15	23	10	10	26	3	25	21	21
HB	125	190	250	270	300	180	275	300	350	200	325	200	240	180	180	260	160	250	130	230
Recommend	◎	◎	◎	◎	◎	◎	◎	◎	◎	◎	◎	◎	◎	◎	◎	◎	◎	◎	◎	◎

ISO Material Description	N					S					H										
	Aluminum-wrought alloy		Aluminum-cast, alloyed			Copper and Copper Alloys (Bronze / Brass)		Non Metallic Materials			Heat Resistant Super Alloys					Titanium Alloys		Hardened steel	Chilled Cast Iron	Hardened Cast Iron	
VDI 3323	21	22	23	24	25	26	27	28	29	30	31	32	33	34	35	36	37	38	39	40	41
HRc	21	22	23	24	25	26	27	28	29	30	15	30	25	38	34	55	60	42	55	42	55
HB	60	100	75	90	130	110	90	100			200	280	250	350	320	400 Rm	1050 Rm	550	630	400	550
Recommend						○	○	○													

YG ONLY ONE
COATED PM60 END MILLS

FLAT SHANK **YG52** SERIES

PM60, 4 FLUTE MULTIPLE HELIX SHORT LENGTH (Center Cut)

- PM60, 4 Schneiden, mit ungleichem Drall, kurz, Zentrumschnitt
- Revêtue YG-AICrN - PM60, 4 dents, hélice multiple, série courte (Coupe au centre)
- Rivestita PM60, 4 TAGLIENTI elica variabile SERIE CORTA (Tagliente al centro)

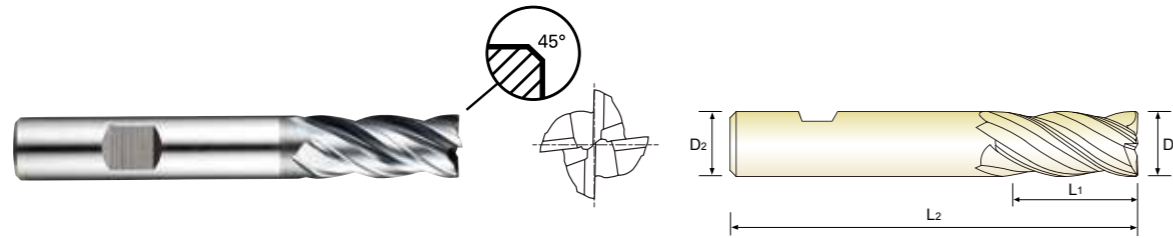

PM 60
4
35°/37°
FLAT
C x 45°
Coating
p.C601

Flat Shank	Page	Plain Shank	Page
END MILL HOLDER	D118-137	POWER MILLING CHUCK	D161-176
		ER COLLET CHUCK	D73-116
		SK SLIM CHUCK	D183-201

Unit : mm

EDP No.	Mill Diameter		Shank Diameter		Length of Cut		Overall Length		Chamfer
	D1	D2	D1	D2	L1	L2	L1	L2	
YG52030	3.0	6	6	6	8	52	0.1	0.1	
YG52040	4.0	6	6	6	11	55	0.1	0.1	
YG52050	5.0	6	6	6	13	57	0.1	0.1	
YG52060	6.0	6	6	6	13	57	0.1	0.1	
YG52070	7.0	8	8	8	16	66	0.1	0.1	
YG52080	8.0	8	8	8	19	69	0.1	0.1	
YG52090	9.0	10	10	10	19	69	0.1	0.1	
YG52100	10.0	10	10	10	22	72	0.1	0.1	
YG52120	12.0	12	12	12	26	83	0.1	0.1	
YG52140	14.0	12	12	12	26	83	0.2	0.2	
YG52160	16.0	16	16	16	32	92	0.2	0.2	
YG52180	18.0	16	16	16	32	92	0.2	0.2	
YG52200	20.0	20	20	20	38	104	0.2	0.2	
YG52220	22.0	20	20	20	38	104	0.2	0.2	
YG52250	25.0	25	25	25	45	121	0.2	0.2	

Mill Dia. Tolerance (mm)	Shank Dia. Tolerance
0 ~ -0.03	h6

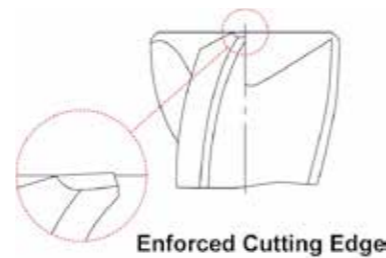

◎ : Excellent ○ : Good

ISO Material Description	P										M				K					
	Non-alloy steel					Low alloy steel					High alloyed steel, and tool steel		Stainless steel		Grey cast iron		Nodular cast iron		Malleable cast iron	
VDI 3323	1	2	3	4	5	6	7	8	9	10	11	12	13	14	15	16	17	18	19	20
HRc	13	25	28	32	38	10	29	32	38	15	35	15	23	10	10	26	3	25	21	21
HB	125	190	250	270	300	180	275	300	350	200	325	200	240	180	180	260	160	250	130	230
Recommend	◎	◎	◎	◎	◎	◎	◎	◎	◎	◎	◎	◎	◎	◎	◎	◎	◎	◎	◎	◎

ISO Material Description	N					S					H											
	Aluminum-wrought alloy		Aluminum-cast, alloyed			Copper and Copper Alloys (Bronze / Brass)			Non Metallic Materials		Heat Resistant Super Alloys					Titanium Alloys		Hardened steel		Chilled Cast Iron		Hardened Cast Iron
VDI 3323	21	22	23	24	25	26	27	28	29	30	31	32	33	34	35	36	37	38	39	40	41	
HRc	21	22	23	24	25	26	27	28	29	30	15	30	25	38	34	55	60	42	55	42	55	
HB	60	100	75	90	130	110	90	100			200	280	250	350	320	400 Rm	1050 Rm	550	630	400	550	
Recommend						○	○	○														

YG ONLY ONE
COATED PM60 END MILLS

PLAIN SHANK **YG76** SERIES
FLAT SHANK **YG02** SERIES

PM60, 4 FLUTE LONG LENGTH (Center Cut)

- PM60, 4 Schneiden, lang, Zentrumschnitt
- Revêtue YG-AICrN - PM60, 4 dents, série longue (Coupe au centre)
- Rivestita PM60, 4 TAGLIENTI SERIE LUNGA (Tagliente al centro)

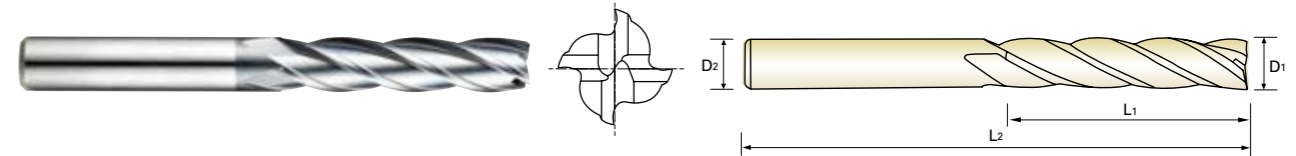

PM 60
4
30°
PLAIN
FLAT
Coating
p.C600

Flat Shank	Page	Plain Shank	Page
END MILL HOLDER	D118-137	POWER MILLING CHUCK	D161-176
		ER COLLET CHUCK	D73-116
		SK SLIM CHUCK	D183-201

Unit : mm

EDP No.		Mill Diameter		Shank Diameter		Length of Cut		Overall Length	
PLAIN	FLAT	D1	D2	D1	D2	L1	L2	L1	L2
YG76020	YG02020	2.0	6	6	6	10	54		
YG76030	YG02030	3.0	6	6	6	12	56		
YG76040	YG02040	4.0	6	6	6	19	63		
YG76050	YG02050	5.0	6	6	6	24	68		
YG76060	YG02060	6.0	6	6	6	24	68		
YG76070	YG02070	7.0	8	8	8	30	80		
YG76080	YG02080	8.0	8	8	8	38	88		
YG76090	YG02090	9.0	10	10	10	38	88		
YG76100	YG02100	10.0	10	10	10	45	95		
YG76120	YG02120	12.0	12	12	12	53	110		
YG76140	YG02140	14.0	12	12	12	53	110		
YG76160	YG02160	16.0	16	16	16	63	123		
YG76180	YG02180	18.0	16	16	16	63	123		
YG76200	YG02200	20.0	20	20	20	75	141		
YG76220	YG02220	22.0	20	20	20	75	141		
YG76250	YG02250	25.0	25	25	25	90	166		

Mill Dia. Tolerance (mm)	Shank Dia. Tolerance
0 ~ -0.03	h6

◎ : Excellent ○ : Good

ISO Material Description	P										M				K					
	Non-alloy steel					Low alloy steel					High alloyed steel, and tool steel		Stainless steel		Grey cast iron		Nodular cast iron		Malleable cast iron	
VDI 3323	1	2	3	4	5	6	7	8	9	10	11	12	13	14	15	16	17	18	19	20
HRc	13	25	28	32	38	10	29	32	38	15	35	15	23	10	10	26	3	25	21	21
HB	125	190	250	270	300	180	275	300	350	200	325	200	240	180	180	260	160	250	130	230
Recommend	◎	◎	◎	◎	◎	◎	◎	◎	◎	◎	◎	◎	◎	◎	◎	◎	◎	◎	◎	◎

ISO Material Description	N					S					H											
	Aluminum-wrought alloy		Aluminum-cast, alloyed			Copper and Copper Alloys (Bronze / Brass)			Non Metallic Materials		Heat Resistant Super Alloys					Titanium Alloys		Hardened steel		Chilled Cast Iron		Hardened Cast Iron
VDI 3323	21	22	23	24	25	26	27	28	29	30	31	32	33	34	35	36	37	38	39	40	41	
HRc	21	22	23	24	25	26	27	28	29	30	15	30	25	38	34	55	60	42	55	42	55	
HB	60	100	75	90	130	110	90	100			200	280	250	350	320	400 Rm	1050 Rm	550	630	400	550	
Recommend						○	○	○														

PM60, MULTI FLUTE MULTIPLE HELIX SHORT LENGTH CORNER RADIUS ROUGHING - FINE (Center Cut)

- PM60, Mehrschneiden, mit ungleichem Drall, kurz, Eckenradius, Feinkordel-Schruppfräser, Zentrumschnitt
- Revêtue YG-AiCrN - PM60, multi-dents, hélice multiple, série courte, rayonnée, ravageuse, pas fins (Coupe au centre)
- Rivestita PM60, MULTI TAGLIENTE ELICA VARIABILE SERIE CORTA TORICA PER SGROSSATURA - BOMBATO FINE (Tagliante al centro)

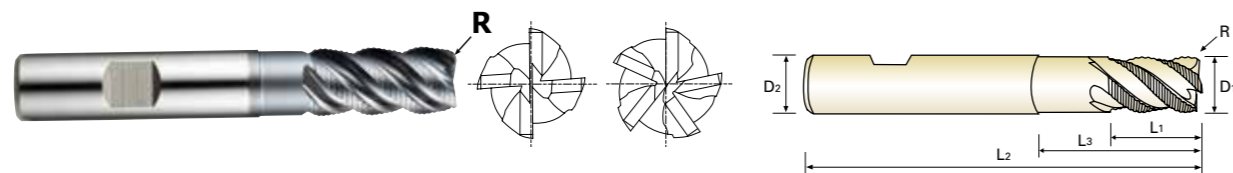

PM 60
4-5
44°/44.5°/45°
HR
FLAT
Coating
p.C602

Flat Shank	Page	Plain Shank	Page
END MILL HOLDER	D118-137	POWER MILLING CHUCK	D161-176
		ER COLLET CHUCK	D73-116
		SK SLIM CHUCK	D183-201

Unit : mm

EDP No.	Corner Radius	Mill Diameter	Shank Diameter	Length of Cut	Length Below Shank	Overall Length	No. of Flute
	R	D1(js12)	D2(h6)	L1	L3	L2	
GYF95060	R0.5	6.0	6	13	-	57	4
GYF95070	R0.5	7.0	10	16	-	66	4
GYF95080	R0.5	8.0	10	19	-	69	4
GYF95090	R0.5	9.0	10	19	-	69	4
GYF95100	R0.5	10.0	10	22	31	72	4
GYF95120	R0.5	12.0	12	26	37	83	4
GYF95140	R1.0	14.0	12	26	-	83	5
GYF95160	R1.0	16.0	16	32	44	92	5
GYF95180	R1.0	18.0	16	32	-	92	5
GYF95200	R1.0	20.0	20	38	54	104	5
GYF95250	R1.0	25.0	25	45	63	121	5

Tolerances according to DIN 7160 & 7161

	Tolerance range in μm		
	Nominal-Diameter in mm		
	over 6 to 10	over 10 to 18	over 18 to 30
js12	± 75	± 90	± 105
h6	0 - 9	0 - 11	0 - 13

◎ : Excellent ○ : Good

ISO Material Description	P										M				K					
	Non-alloy steel					Low alloy steel					High alloyed steel, and tool steel		Stainless steel		Grey cast iron		Nodular cast iron		Malleable cast iron	
VDI 3323	1	2	3	4	5	6	7	8	9	10	11	12	13	14	15	16	17	18	19	20
HRc	13	25	28	32	35	38	42	46	50	55	60	65	70	75	80	85	90	95	100	105
HB	125	190	250	270	300	180	275	300	350	200	325	200	240	180	180	260	160	250	130	230
Recommend	◎	◎	◎	◎	◎	◎	◎	◎	◎	◎	◎	◎	◎	◎	◎	◎	◎	◎	◎	◎

ISO Material Description	N										S				H						
	Aluminum-wrought alloy		Aluminum-cast, alloyed			Copper and Copper Alloys (Bronze / Brass)			Non Metallic Materials		Heat Resistant Super Alloys				Titanium Alloys		Hardened steel		Chilled Cast Iron		Hardened Cast Iron
VDI 3323	21	22	23	24	25	26	27	28	29	30	31	32	33	34	35	36	37	38	39	40	41
HRc	21	22	23	24	25	26	27	28	29	30	31	32	33	34	35	36	37	38	39	40	41
HB	60	100	75	90	130	110	90	100			200	280	250	350	320	400 Rm	1050 Rm	550	630	400	550
Recommend																					

PM60, MULTI FLUTE SHORT LENGTH ROUGHING - FINE (Center Cut)

- PM60, Mehrschneiden, kurz, Feinkordel-Schruppfräser, Zentrumschnitt
- Revêtue YG-AiCrN - PM60, multi-dents, série courte, ravageuse, pas fins (Coupe au centre)
- Rivestita PM60, MULTI TAGLIENTE SERIE CORTA PER SGROSSATURA - BOMBATO FINE (Tagliante al centro)

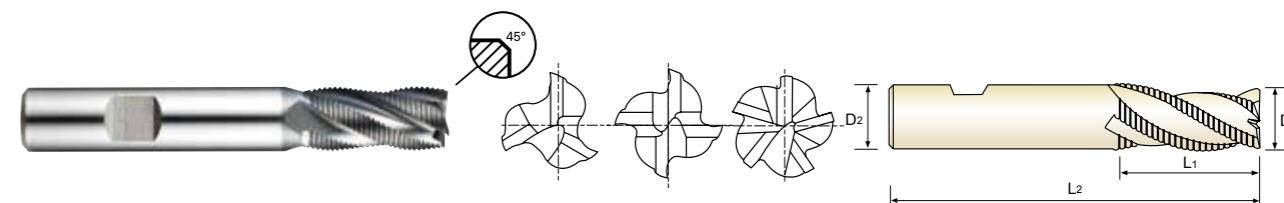

PM 60
3-5
30°
HR
FLAT
C x 45°
Coating
p.C603

Flat Shank	Page	Plain Shank	Page
END MILL HOLDER	D118-137	POWER MILLING CHUCK	D161-176
		ER COLLET CHUCK	D73-116
		SK SLIM CHUCK	D183-201

Unit : mm

EDP No.	Mill Diameter	Shank Diameter	Length of Cut	Overall Length	No. of Flute	Chamfer
	D1(js12)	D2(h6)	L1	L2		
GYF94060	6.0	6	13	57	3	0.18
GYF94070	7.0	10	16	66	3	0.18
GYF94080	8.0	10	19	69	3	0.18
GYF94090	9.0	10	19	69	3	0.18
GYF94100	10.0	10	22	72	4	0.18
GYF94120	12.0	12	26	83	4	0.18
GYF94140	14.0	12	26	83	4	0.25
GYF94160	16.0	16	32	92	4	0.25
GYF94180	18.0	16	32	92	4	0.25
GYF94200	20.0	20	38	104	4	0.25
GYF94250	25.0	25	45	121	5	0.36

Tolerances according to DIN 7160 & 7161

	Tolerance range in μm		
	Nominal-Diameter in mm		
	over 6 to 10	over 10 to 18	over 18 to 30
js12	± 75	± 90	± 105
h6	0 - 9	0 - 11	0 - 13

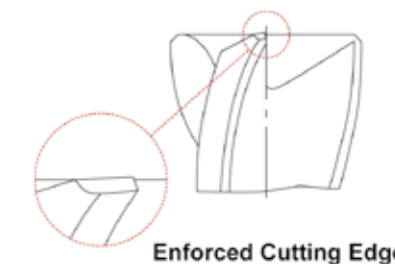

Enforced Cutting Edge

◎ : Excellent ○ : Good

ISO Material Description	P										M				K					
	Non-alloy steel					Low alloy steel					High alloyed steel, and tool steel		Stainless steel		Grey cast iron		Nodular cast iron		Malleable cast iron	
VDI 3323	1	2	3	4	5	6	7	8	9	10	11	12	13	14	15	16	17	18	19	20
HRc	13	25	28	32	35	38	42	46	50	55	60	65	70	75	80	85	90	95	100	105
HB	125	190	250	270	300	180	275	300	350	200	325	200	240	180	180	260	160	250	130	230
Recommend	◎	◎	◎	◎	◎	◎	◎	◎	◎	◎	◎	◎	◎	◎	◎	◎	◎	◎	◎	◎

ISO Material Description	N										S				H						
	Aluminum-wrought alloy		Aluminum-cast, alloyed			Copper and Copper Alloys (Bronze / Brass)			Non Metallic Materials		Heat Resistant Super Alloys				Titanium Alloys		Hardened steel		Chilled Cast Iron		Hardened Cast Iron
VDI 3323	21	22	23	24	25	26	27	28	29	30	31	32	33	34	35	36	37	38	39	40	41
HRc	21	22	23	24	25	26	27	28	29	30	31	32	33	34	35	36	37	38	39	40	41
HB	60	100	75	90	130	110	90	100			200	280	250	350	320	400 Rm	1050 Rm	550	630	400	550
Recommend																					

PM60, MULTI FLUTE LONG LENGTH ROUGHING - FINE (Center Cut)

- PM60, Mehrschneiden, lang, Feinkordel-Schruppfräser, Zentrumschnitt
- Revêtue YG-AICrN - PM60, multi-dents, série longue, ravageuse, pas fins (Coupe au centre)
- Rivestita PM60, MULTI TAGLIENTE SERIE LUNGA PER SGROSSATURA - BOMBATO FINE (Tagliante al centro)

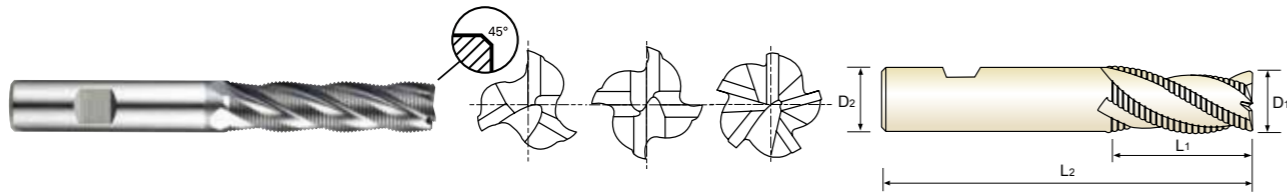

PM 60
3-5
30°
HR
FLAT
C x 45°
Coating
p.C603
Recommended Toolholder

Flat Shank	Page	Plain Shank	Page
END MILL HOLDER	D118-137	POWER MILLING CHUCK	D161-176
		ER COLLET CHUCK	D73-116
		SK SLIM CHUCK	D183-201

Unit : mm

EDP No.	Mill Diameter	Shank Diameter	Length of Cut	Overall Length	No. of Flute	Chamfer
	D1(js12)	D2(h6)	L1	L2		
GYF98060	6.0	6	24	68	3	0.18
GYF98070	7.0	10	30	80	3	0.18
GYF98080	8.0	10	38	88	3	0.18
GYF98090	9.0	10	38	88	3	0.18
GYF98100	10.0	10	45	95	4	0.18
GYF98120	12.0	12	53	110	4	0.18
GYF98140	14.0	12	53	110	4	0.25
GYF98160	16.0	16	63	123	4	0.25
GYF98180	18.0	16	63	123	4	0.25
GYF98200	20.0	20	75	141	4	0.25
GYF98250	25.0	25	90	166	5	0.36

Tolerances according to DIN 7160 & 7161

Tolerance range in μm			
	Nominal-Diameter in mm		
	over 6 to 10	over 10 to 18	over 18 to 30
js12	± 75	± 90	± 105
h6	0 - 9	0 - 11	0 - 13

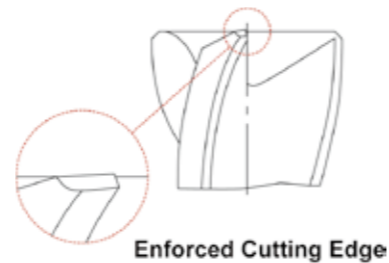

◎ : Excellent ○ : Good

ISO	P										M				K					
	Non-alloy steel					Low alloy steel					High alloyed steel, and tool steel		Stainless steel		Grey cast iron	Nodular cast iron		Malleable cast iron		
Material Description	1	2	3	4	5	6	7	8	9	10	11	12	13	14	15	16	17	18	19	20
VDI 3323	1	2	3	4	5	6	7	8	9	10	11	12	13	14	15	16	17	18	19	20
HRc	13	25	28	32	38	42	48	52	58	63	68	73	78	83	88	93	98	103	108	113
HB	125	190	250	270	300	180	275	300	350	200	325	200	240	180	180	260	160	250	130	230
Recommend	◎	◎	◎	◎	◎	◎	◎	◎	◎	◎	◎	◎	◎	◎	◎	◎	◎	◎	◎	◎

ISO	N					S					H										
	Aluminum-wrought alloy		Aluminum-cast, alloyed			Copper and Copper Alloys (Bronze / Brass)		Non Metallic Materials			Heat Resistant Super Alloys					Titanium Alloys		Hardened steel	Chilled Cast Iron	Hardened Cast Iron	
Material Description	21	22	23	24	25	26	27	28	29	30	31	32	33	34	35	36	37	38	39	40	41
VDI 3323	21	22	23	24	25	26	27	28	29	30	31	32	33	34	35	36	37	38	39	40	41
HRc	21	22	23	24	25	26	27	28	29	30	31	32	33	34	35	36	37	38	39	40	41
HB	60	100	75	90	130	110	90	100			200	280	250	350	320	400 Rm	1050 Rm	550	630	400	550
Recommend	◎	◎	◎	◎	◎	◎	◎	◎	◎	◎	◎	◎	◎	◎	◎	◎	◎	◎	◎	◎	◎

PM60, MULTI FLUTE SHORT LENGTH ROUGHING - COARSE (Center Cut)

- PM60, Mehrschneiden, kurz, Schrappfräser, Zentrumschnitt
- Revêtue YG-AICrN - PM60, multi-dents, série courte, ravageuse, pas grossiers (Coupe au centre)
- Rivestita PM60, MULTI TAGLIENTE SERIE CORTA PER SGROSSATURA - BOMBATO GROSSO (Tagliante al centro)

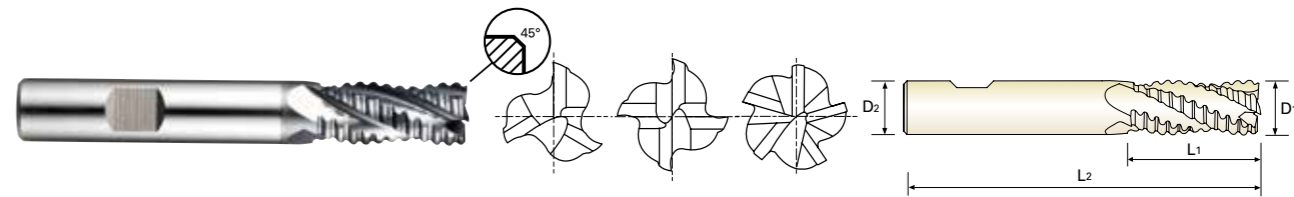

PM 60
3-5
30°
NR
FLAT
C x 45°
Coating
p.C603
Recommended Toolholder

Flat Shank	Page	Plain Shank	Page
END MILL HOLDER	D118-137	POWER MILLING CHUCK	D161-176
		ER COLLET CHUCK	D73-116
		SK SLIM CHUCK	D183-201

Unit : mm

EDP No.	Mill Diameter	Shank Diameter	Length of Cut	Overall Length	No. of Flute	Chamfer
	D1(js12)	D2(h6)	L1	L2		
GYG03060	6.0	6	13	57	3	0.25
GYG03070	7.0	10	16	66	3	0.25
GYG03080	8.0	10	19	69	3	0.25
GYG03090	9.0	10	19	69	3	0.36
GYG03100	10.0	10	22	72	4	0.36
GYG03120	12.0	12	26	83	4	0.56
GYG03140	14.0	12	26	83	4	0.6
GYG03160	16.0	16	32	92	4	0.6
GYG03180	18.0	16	32	92	4	0.6
GYG03200	20.0	20	38	104	4	0.6
GYG03250	25.0	25	45	121	5	0.6

Tolerances according to DIN 7160 & 7161

Tolerance range in μm			
	Nominal-Diameter in mm		
	over 6 to 10	over 10 to 18	over 18 to 30
js12	± 75	± 90	± 105
h6	0 - 9	0 - 11	0 - 13

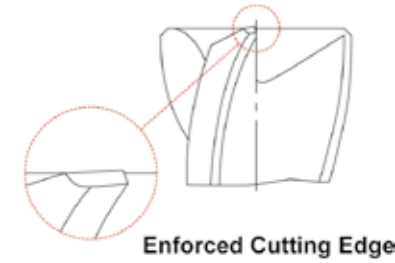

◎ : Excellent ○ : Good

ISO	P										M				K					
	Non-alloy steel					Low alloy steel					High alloyed steel, and tool steel		Stainless steel		Grey cast iron	Nodular cast iron		Malleable cast iron		
Material Description	1	2	3	4	5	6	7	8	9	10	11	12	13	14	15	16	17	18	19	20
VDI 3323	1	2	3	4	5	6	7	8	9	10	11	12	13	14	15	16	17	18	19	20
HRc	13	25	28	32	38	42	48	52	58	63	68	73	78	83	88	93	98	103	108	113
HB	125	190	250	270	300	180	275	300	350	200	325	200	240	180	180	260	160	250	130	230
Recommend	◎	◎	◎	◎	◎	◎	◎	◎	◎	◎	◎	◎	◎	◎	◎	◎	◎	◎	◎	◎

ISO	N					S					H										
	Aluminum-wrought alloy		Aluminum-cast, alloyed			Copper and Copper Alloys (Bronze / Brass)		Non Metallic Materials			Heat Resistant Super Alloys					Titanium Alloys		Hardened steel	Chilled Cast Iron	Hardened Cast Iron	
Material Description	21	22	23	24	25	26	27	28	29	30	31	32	33	34	35	36	37	38	39	40	41
VDI 3323	21	22	23	24	25	26	27	28	29	30	31	32	33	34	35	36	37	38	39	40	41
HRc	21	22	23	24	25	26	27	28	29	30	31	32	33	34	35	36	37	38	39	40	41
HB	60	100	75	90	130	110	90	100			200	280	250	350	320	400 Rm	1050 Rm	550	630	400	550
Recommend	◎	◎	◎	◎	◎	◎	◎	◎	◎	◎	◎	◎	◎	◎	◎	◎	◎	◎	◎	◎	◎



ONLY ONE
COATED PM60 END MILLS

RECOMMENDED CUTTING CONDITIONS
EMPFOHLENE SCHNEIDPARAMETER

GYG77 , GYF97 SERIES 2 FLUTE BALL NOSE

Vc = m/min.
fz = mm/tooth
RPM = rev./min.
FEED = mm/min.

ISO	VDI 3323	Material Description	Ae	Ap	Parameter	Diameter (Ø)										
						3.0	4.0	6.0	8.0	10.0	12.0	16.0	20.0	25.0		
P	1	Non-alloy steel	0.5D	0.2D	Vc	83	90	100	101	104	104	103	102	90		
					fz	0.023	0.036	0.054	0.079	0.109	0.115	0.141	0.156	0.162		
					RPM	8807	7162	5305	4019	3310	2759	2049	1623	1146		
					FEED	405	516	573	635	722	634	578	506	371		
	2		Vc	66	70	79	78	79	81	78	75	70				
			fz	0.020	0.032	0.046	0.067	0.095	0.097	0.123	0.140	0.140				
			RPM	7003	5570	4191	3104	2515	2149	1552	1194	891				
			FEED	280	357	386	416	478	417	382	334	250				
	3-4		Vc	44	45	52	54	53	54	52	44					
			fz	0.016	0.026	0.039	0.056	0.082	0.083	0.1	0.11	0.125				
			RPM	4669	3581	2759	2149	1687	1432	1074	828	560				
			FEED	149	186	215	241	277	238	215	182	140				
5	Vc	23	24	27	27	26	27	27	24							
	fz	0.014	0.023	0.035	0.047	0.073	0.071	0.090	0.099	0.100						
	RPM	2440	1910	1432	1074	828	690	537	430	306						
	FEED	68	88	100	101	121	98	97	85	61						
6	Vc	66	70	79	78	79	81	78	75	70						
	fz	0.020	0.032	0.046	0.067	0.095	0.097	0.123	0.140	0.140						
	RPM	7003	5570	4191	3104	2515	2149	1552	1194	891						
	FEED	280	357	386	416	478	417	382	334	250						
7	Vc	44	45	52	54	53	54	52	44							
	fz	0.016	0.026	0.039	0.056	0.082	0.083	0.1	0.11	0.125						
	RPM	4669	3581	2759	2149	1687	1432	1074	828	560						
	FEED	149	186	215	241	277	238	215	182	140						
8-9	Vc	23	24	27	27	26	27	27	24							
	fz	0.014	0.023	0.035	0.047	0.073	0.071	0.090	0.099	0.100						
	RPM	2440	1910	1432	1074	828	690	537	430	306						
	FEED	68	88	100	101	121	98	97	85	61						
10	Vc	66	70	79	78	79	81	78	75	70						
	fz	0.020	0.032	0.046	0.067	0.095	0.097	0.123	0.140	0.140						
	RPM	7003	5570	4191	3104	2515	2149	1552	1194	891						
	FEED	280	357	386	416	478	417	382	334	250						
11.1	Vc	23	24	27	27	26	27	27	24							
	fz	0.014	0.023	0.035	0.047	0.073	0.071	0.090	0.099	0.100						
	RPM	2440	1910	1432	1074	828	690	537	430	306						
	FEED	68	88	100	101	121	98	97	85	61						
11.2	Vc	16	17	19	19	18	19	19	16							
	fz	0.013	0.024	0.035	0.047	0.075	0.071	0.088	0.1	0.095						
	RPM	1698	1353	1008	756	573	477	378	302	204						
	FEED	44	65	71	71	86	67	60	39							
M 14.1	Vc	25	27	30	30	28	29	30	26							
	fz	0.013	0.023	0.036	0.049	0.072	0.075	0.093	0.099	0.098						
	RPM	2653	2149	1592	1194	891	769	597	477	331						
	FEED	69	99	115	117	128	115	111	95	65						
K 15-20	Vc	66	70	79	78	79	81	78	75	70						
	fz	0.02	0.032	0.046	0.067	0.095	0.097	0.123	0.14	0.14						
	RPM	7003	5570	4191	3104	2515	2149	1552	1194	891						
	FEED	280	357	386	416	478	417	382	334	250						
H 40	Vc	16	17	19	19	18	19	19	16							
	fz	0.013	0.024	0.035	0.047	0.075	0.071	0.088	0.1	0.095						
	RPM	1698	1353	1008	756	573	477	378	302	204						
	FEED	44	65	71	71	86	67	60	39							

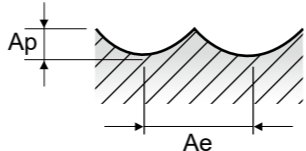

ONLY ONE
COATED PM60 END MILLS

RECOMMENDED CUTTING CONDITIONS
EMPFOHLENE SCHNEIDPARAMETER

GYG72 , GYF99 SERIES 2 FLUTE - SLOTTING

Vc = m/min.
fz = mm/tooth
RPM = rev./min.
FEED = mm/min.

ISO	VDI 3323	Material Description	Ae	Ap	Parameter	Diameter (Ø)															
						2.0	3.0	4.0	5.0	6.0	8.0	10.0	12.0	14.0	16.0	18.0	20.0	22.0	25.0		
P	1	Non-alloy steel	1.0D	0.5D	Vc	53	57	65	74	79	78	79	81	84	81	78	72	70	71		
					fz	0.008	0.016	0.027	0.033	0.038	0.053	0.071	0.076	0.083	0.099	0.105	0.116	0.109	0.103		
					RPM	8435	6048	5173	4711	4191	3104	2515	2149	1910	1611	1379	1146	1013	904		
					FEED	135	194	279	311	319	329	357	327	317	319	290	266	221	186		
	2		Vc	44	46	54	61	66	66	68	66	66	69	64	59	59	60				
			fz	0.008	0.016	0.024	0.031	0.036	0.055	0.074	0.083	0.083	0.085	0.103	0.106	0.106	0.112				
			RPM	7003	4881	4297	3883	3501	2626	2165	1751	1501	1373	1132	939	854	764				
			FEED	112	156	206	241	252	289	320	291	249	233	193	191	181	171				
	3-4		Vc	37	38	48	49	52	54	55	52	53	54	54	53	50	46				
			fz	0.008	0.017	0.025	0.035	0.042	0.056	0.079	0.091	0.098	0.1	0.1	0.107	0.104	0.119				
			RPM	5889	4032	3820	3119	2759	2149	1751	1379	1205	1074	955	844	723	586				
			FEED	94	137	191	218	232	241	277	251	236	215	191	181	150	139				
5	Vc	24	26	30	32	33	35	34	34	33	34	34	33	33	34						
	fz	0.011	0.017	0.023	0.029	0.037	0.051	0.069	0.079	0.086	0.09	0.1	0.104	0.099	0.105						
	RPM	3820	2759	2387	2037	1751	1393	1082	902	750	676	601	525	477	433						
	FEED	84	94	110	118	130	142	149	142	129	122	120	109	95	91						
6	Vc	44	46	54	61	66	66	68	66	66	69	64	59	59	60						
	fz	0.008	0.016	0.024	0.031	0.036	0.055	0.074	0.083	0.083	0.085	0.103	0.106	0.106	0.112						
	RPM	7003	4881	4297	3883	3501	2626	2165	1751	1501	1373	1132	939	854	764						
	FEED	112	156	206	241	252	289	320	291	249	233	193	191	181	171						
7	Vc	37	38	48	49	52	54	55	52	53	54	54	53	50	46						
	fz	0.008	0.017	0.025	0.035	0.042	0.056	0.079	0.091	0.098	0.1	0.1	0.107	0.104	0.119						
	RPM	5889	4032	3820	3119	2759	2149	1751	1379	1205	1074	955	844	723	586						
	FEED	94	137	191	218	232	241	277	251	236	215	191	181	150	139						
8	Vc	24	26	30	32	33	35	34	34	33	34	34	33	33	34						
	fz	0.011	0.017	0.023	0.029	0.037	0.051	0.069	0.079	0.086	0.09	0.1	0.104	0.099	0.105						
	RPM	3820	2759	2387	2037	1751	1393	1082	902	750	676	601	525	477	433						
	FEED	84	94	110	118	130	142	149	142	129	122	120	109	95	91						
9	Vc	15	20	24	25	26	27	26	26	26	27	27	27	26	24						
	fz	0.01	0.017	0.023	0.028	0.036	0.047	0.071	0.071	0.079	0.09	0.094	0.099	0.086	0.1						
	RPM	2387	2122	1910	1592	1379	1074	828	690	591	537	477	430	376	306						
	FEED	48	72	88	89	99	101	118	98	93	97	90	85	65	61						
10	Vc	44	46	54	61	66	66	68	66	66	69	64	59	59	60						
	fz	0.008	0.016	0.024	0.031	0.036	0.055	0.074	0.083	0.083	0.085	0.103	0.106	0.106	0.112						
	RPM	7003	4881	4297	3883	3501	2626	2165	1751	1501	1373	1132	939	854	764						
	FEED	112	156	206	241	252	289	320	291	249	233	193	191	181	171						
11.1	Vc	24	26	30	32	33	35	34	34	33	34	34	33	33	34						
	fz	0.011	0.017	0.023	0.029	0.037	0.051	0.069	0.079	0.086	0.09	0.1	0.104	0.099	0.105						
	RPM	3820	2759	2387	2037	1751	1393	1082	902	750	676	601	525	477	433						
	FEED	84	94	110	118	130	142	149	142	129	122	120	109	95	91						
11.2	Vc	11	14	17	18	18	19	19	18	18	19	19	19	19	16						
	fz	0.01	0.018	0.024	0.029	0.036	0.047	0.072	0.071	0.077	0.088	0.096	0.1	0.083	0.095						
	RPM	1751	1485	1353	1146	955	756	605	477	409	378	336	302	275	204						
	FEED	35	53	65	66	69	71	87	68	63	67	65	60	46	39						
M 14.1	Vc	17	22	27	28	29	30	29	29	29	29	30	30	29	26						
	fz	0.01	0.018	0.024	0.028	0.036	0.047	0.071	0.071	0.077	0.088	0.096	0.1	0.083	0.095						
	RPM	2706	2334</																		



ONLY ONE COATED PM60 END MILLS

RECOMMENDED CUTTING CONDITIONS EMPFOHLENE SCHNEIDPARAMETER

GYG01 SERIES

3 FLUTE - SLOTTING

Vc = m/min. fz = mm/tooth RPM = rev./min. FEED = mm/min.

Table with columns: ISO, VDI 3323, Material Description, Ae, Ap, Parameter, Diameter (Ø) (2.0-25.0), Vc, fz, RPM, FEED. Rows include P (Non-alloy steel, Low alloy steel, High alloyed steel, and tool steel), M (Stainless steel), K (Grey cast iron, Nodular cast iron, Malleable cast iron), and H (Chilled Cast Iron).

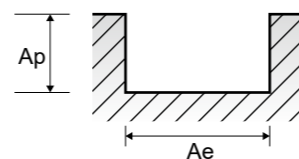

ONLY ONE COATED PM60 END MILLS

RECOMMENDED CUTTING CONDITIONS EMPFOHLENE SCHNEIDPARAMETER

GYG01 SERIES

3 FLUTE - SIDE CUTTING

Vc = m/min. fz = mm/tooth RPM = rev./min. FEED = mm/min.

Table with columns: ISO, VDI 3323, Material Description, Ae, Ap, Parameter, Diameter (Ø) (2.0-25.0), Vc, fz, RPM, FEED. Rows include P (Non-alloy steel, Low alloy steel, High alloyed steel, and tool steel), M (Stainless steel), K (Grey cast iron, Nodular cast iron, Malleable cast iron), and H (Chilled Cast Iron).

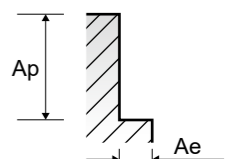

YG **ONLY ONE** COATED PM60 END MILLS

RECOMMENDED CUTTING CONDITIONS
EMPFOHLENE SCHNEIDPARAMETER

YG **ONLY ONE** COATED PM60 END MILLS

RECOMMENDED CUTTING CONDITIONS
EMPFOHLENE SCHNEIDPARAMETER

- CBN END MILLS
- i-Xmill END MILLS
- i-SMART MODULAR END MILLS
- X5070 END MILLS
- 4G MILL END MILLS
- X-POWER PRO END MILLS
- TitaNox-POWER END MILLS
- JET-POWER END MILLS
- V7 PLUS END MILLS
- ALU-POWER HPC END MILLS
- ALU-POWER END MILLS
- D-POWER GRAPHITE END MILLS
- CRX S END MILLS
- K-2 END MILLS
- ONLY ONE COATED PM60 END MILLS
- TANK-POWER END MILLS
- GENERAL HSS END MILLS
- MILLING CUTTERS
- TECHNICAL DATA

- CBN END MILLS
- i-Xmill END MILLS
- i-SMART MODULAR END MILLS
- X5070 END MILLS
- 4G MILL END MILLS
- X-POWER PRO END MILLS
- TitaNox-POWER END MILLS
- JET-POWER END MILLS
- V7 PLUS END MILLS
- ALU-POWER HPC END MILLS
- ALU-POWER END MILLS
- D-POWER GRAPHITE END MILLS
- CRX S END MILLS
- K-2 END MILLS
- ONLY ONE COATED PM60 END MILLS
- TANK-POWER END MILLS
- GENERAL HSS END MILLS
- MILLING CUTTERS
- TECHNICAL DATA

GYG74, GYF96, GYG76, GYG02 SERIES 4 FLUTE - SIDE CUTTING

Vc = m/min.
fz = mm/tooth
RPM = rev/min.
FEED = mm/min.

ISO	VDI 3323	Material Description	Ae	Ap	Parameter	Diameter (Ø)														
						2.0	3.0	4.0	5.0	6.0	8.0	10.0	12.0	14.0	16.0	18.0	20.0	22.0	25.0	
P	1	Non-alloy steel	0.1D	1.5D	Vc	69	75	80	83	88	93	87	90	95	97	102	94	87	94	
					fz	0.008	0.015	0.023	0.029	0.035	0.046	0.068	0.071	0.076	0.079	0.076	0.088	0.097	0.093	
	RPM		10982	7958	6366	5284	4669	3700	2769	2387	2160	1930	1804	1496	1259	1197				
	FEED		351	477	586	613	654	681	753	678	657	610	548	527	488	445				
	2		0.1D	1.5D	Vc	63	68	71	75	81	78	79	81	84	84	85	79	79	79	
					fz	0.007	0.015	0.021	0.026	0.031	0.046	0.063	0.067	0.072	0.077	0.08	0.088	0.084	0.09	
	RPM		10027	7215	5650	4775	4297	3104	2515	2149	1910	1671	1503	1257	1143	1006				
	FEED		281	433	475	497	533	571	634	576	550	515	481	443	384	362				
	3-4		0.1D	1.5D	Vc	46	50	54	55	59	60	60	63	58	60	61	59	57	60	
					fz	0.007	0.014	0.021	0.028	0.032	0.046	0.059	0.066	0.08	0.085	0.086	0.088	0.093	0.09	
RPM	7321	5305	4297	3501	3130	2387	1910	1671	1319	1194	1079	939	825	764						
FEED	205	297	361	392	401	439	451	441	422	406	371	331	307	275						
5	0.1D	1.5D	Vc	31	31	35	38	41	42	38	40	42	41	43	40	39	39			
			fz	0.008	0.017	0.022	0.028	0.032	0.043	0.067	0.068	0.072	0.081	0.077	0.082	0.085	0.09			
RPM	4934	3289	2785	2419	2175	1671	1210	1061	955	816	760	637	564	497						
FEED	158	224	245	271	278	287	324	289	275	264	234	209	192	179						
6	0.1D	1.5D	Vc	63	68	71	75	81	78	79	81	84	84	85	79	79	79			
			fz	0.007	0.015	0.021	0.026	0.031	0.046	0.063	0.067	0.072	0.077	0.08	0.088	0.084	0.09			
RPM	10027	7215	5650	4775	4297	3104	2515	2149	1910	1671	1503	1257	1143	1006						
FEED	281	433	475	497	533	571	634	576	550	515	481	443	384	362						
7	0.1D	1.5D	Vc	46	50	54	55	59	60	60	63	58	60	61	59	57	60			
			fz	0.007	0.014	0.021	0.028	0.032	0.046	0.059	0.066	0.08	0.085	0.086	0.088	0.093	0.09			
RPM	7321	5305	4297	3501	3130	2387	1910	1671	1319	1194	1079	939	825	764						
FEED	205	297	361	392	401	439	451	441	422	406	371	331	307	275						
8	0.1D	1.5D	Vc	31	31	35	38	41	42	38	40	42	41	43	40	39	39			
			fz	0.008	0.017	0.022	0.028	0.032	0.043	0.067	0.068	0.072	0.081	0.077	0.082	0.085	0.09			
RPM	4934	3289	2785	2419	2175	1671	1210	1061	955	816	760	637	564	497						
FEED	158	224	245	271	278	287	324	289	275	264	234	209	192	179						
9	0.05D	1.5D	Vc	25	27	30	32	33	35	34	32	33	33	34	33	34				
			fz	0.006	0.013	0.019	0.023	0.031	0.04	0.056	0.064	0.067	0.076	0.075	0.08	0.081	0.087			
RPM	3979	2865	2387	2037	1751	1393	1082	849	750	657	601	525	477	433						
FEED	95	149	181	187	217	223	242	217	201	200	180	168	155	151						
10	0.1D	1.5D	Vc	63	68	71	75	81	78	79	81	84	84	85	79	79	79			
			fz	0.007	0.015	0.021	0.026	0.031	0.046	0.063	0.067	0.072	0.077	0.08	0.088	0.084	0.09			
RPM	10027	7215	5650	4775	4297	3104	2515	2149	1910	1671	1503	1257	1143	1006						
FEED	281	433	475	497	533	571	634	576	550	515	481	443	384	362						
11.1	0.1D	1.5D	Vc	31	31	35	38	41	42	38	40	42	41	43	40	39	39			
			fz	0.008	0.017	0.022	0.028	0.032	0.043	0.067	0.068	0.072	0.081	0.077	0.082	0.085	0.09			
RPM	4934	3289	2785	2419	2175	1671	1210	1061	955	816	760	637	564	497						
FEED	158	224	245	271	278	287	324	289	275	264	234	209	192	179						
11.2	0.05D	1.5D	Vc	17	19	21	22	23	24	24	23	23	23	24	23	24				
			fz	0.006	0.013	0.019	0.024	0.031	0.04	0.057	0.065	0.068	0.076	0.074	0.081	0.081	0.088			
RPM	2706	2016	1671	1401	1220	955	764	610	523	458	424	366	333	306						
FEED	65	105	127	134	151	153	174	159	142	139	126	119	108	108						
M	14.1	Stainless steel	0.1D	1.5D	Vc	27	30	33	35	36	38	37	36	37	37	36	37	37		
					fz	0.006	0.013	0.019	0.023	0.031	0.039	0.056	0.063	0.067	0.075	0.076	0.08	0.08	0.088	
RPM	4297	3183	2626	2228	1910	1512	1178	955	841	736	654	573	535	471						
FEED	103	166	200	205	237	236	264	241	225	221	199	183	171	166						
K	15-20	Grey cast iron Nodular cast iron Malleable cast iron	0.1D	1.5D	Vc	63	68	71	75	81	78	79	81	84	84	85	79	79		
					fz	0.007	0.015	0.021	0.026	0.031	0.046	0.063	0.067	0.072	0.077	0.08	0.088	0.084	0.09	
RPM	10027	7215	5650	4775	4297	3104	2515	2149	1910	1671	1503	1257	1143	1006						
FEED	281	433	475	497	533	571	634	576	550	515	481	443	384	362						
H	40	Chilled Cast Iron	0.05D	1.5D	Vc	17	19	21	22	23	24	24	23	23	23	24	23	24		
					fz	0.006	0.013	0.019	0.024	0.031	0.04	0.057	0.065	0.068	0.076	0.074	0.081	0.081	0.088	
RPM	2706	2016	1671	1401	1220	955	764	610	523	458	424	366	333	306						
FEED	65	105	127	134	151	153	174	159	142	139	126	119	108	108						

GYG52 SERIES 4 FLUTE - SLOTTING, SIDE CUTTING

Vc = m/min.
fz = mm/tooth
RPM = rev/min.
FEED = mm/min.

ISO	VDI 3323	Material Description	Slotting		Side Cutting		Parameter	Diameter (Ø)														
			Ae	Ap	Ae	Ap		3.0	4.0	5.0	6.0	8.0	10.0	12.0	14.0	16.0	18.0	20.0	25.0			
P	1-2	Non-alloy steel	1.0D	0.5D	0.3D	1.5D	Vc	70	70	70	70	70	77	77	77	77	77	77	77	77		
							fz	0.005	0.008	0.012	0.016	0.028	0.039	0.047	0.049	0.053	0.059	0.065	0.063			
	RPM		7427	5570	4456	3714	2785	2451	2042	1751	1532	1362	1225	980								
	FEED		149	178	214	238	312	382	384	343	325	321	319	247								
	3-4		0.1D	0.5D	0.3D	1.5D	Vc	64	63	63	64	64	70	70	70	70	70	70	70			
							fz	0.005	0.008	0.011	0.016	0.028	0.039	0.047	0.049	0.053	0.059	0.065	0.063			
	RPM		6791	5013	4011	3395	2546	2228	1857	1592	1393	1238	1114	891								
	FEED		136	160	176	217	285	348	349	312	292	290	290	225								
	5		0.1D	0.5D	0.3D	1.5D	Vc	44	44	44	44	44	49	49	49	49	49	49	49			
							fz	0.005	0.008	0.011	0.016	0.028	0.038	0.047	0.05	0.052	0.059	0.066	0.065			
RPM	4669	3501	2801	2334	1751	1560	1300	1114	975	867	780	624										
FEED	93	112	123	149	196	237	244	223	203	204	206	162										
6	0.1D	0.5D	0.3D	1.5D	Vc	70	70	70	70	70	77	77	77	77	77	77	77					
					fz	0.005	0.008	0.012	0.016	0.028	0.039	0.047	0.049	0.053	0.059	0.065	0.063					
RPM	7427	5570	4456	3714	2785	2451	2042	1751	1532	1362	1225	980										
FEED	149	178	214	238	312	382	384	343	325	321	319	247										
7	0.1D	0.5D	0.3D	1.5D	Vc	64	63	63	64	64	70	70	70	70	70	70						
					fz	0.005	0.008	0.011	0.016	0.028	0.039	0.047	0.049	0.053	0.059	0.065	0.063					
RPM	6791	5013	4011	3395	2546	2228	1857	1592	1393	1238	1114	891										
FEED	136	160	176	217	285	348	349	312	292	290	290	225										
8	0.1D																					



RECOMMENDED CUTTING CONDITIONS
EMPFOHLENE SCHNEIDPARAMETER



RECOMMENDED CUTTING CONDITIONS
EMPFOHLENE SCHNEIDPARAMETER

GYF95 SERIES MULTI FLUTE ROUGHING - SIDE CUTTING

Vc = m/min.
fz = mm/tooth
RPM = rev./min.
FEED = mm/min.

GYF94, GYF98, GYG03 SERIES MULTI FLUTE ROUGHING - SIDE CUTTING

Vc = m/min.
fz = mm/tooth
RPM = rev./min.
FEED = mm/min.

ISO	VDI 3323	Material Description	Ae	Ap	Parameter	Diameter (Ø)												
						6.0	8.0	10.0	12.0	14.0	16.0	18.0	20.0	25.0				
P	1	Non-alloy steel	0.5D	1.5D	Vc	76	87	86	87	89	87	85	87	90				
					fz	0.02	0.03	0.055	0.065	0.059	0.069	0.079	0.088	0.105				
					RPM	4032	3462	2737	2308	2024	1731	1503	1385	1146				
	2		Vc	60	69	68	65	66	69	72	68	68						
			fz	0.021	0.03	0.053	0.069	0.063	0.069	0.074	0.087	0.106						
			RPM	3183	2745	2165	1724	1501	1373	1273	1082	866						
	3		Vc	43	51	47	49	48	48	50	48	47						
			fz	0.018	0.028	0.046	0.063	0.061	0.069	0.075	0.086	0.107						
			RPM	2281	2029	1496	1300	1091	955	884	764	598						
	4		Vc	43	51	47	49	48	48	50	48	47						
			fz	0.018	0.028	0.046	0.063	0.061	0.069	0.075	0.086	0.107						
RPM		2281	2029	1496	1300	1091	955	884	764	598								
5	Vc	35	38	40	40	40	40	40	40	41								
	fz	0.02	0.03	0.045	0.061	0.057	0.066	0.073	0.081	0.1								
	RPM	1857	1512	1273	1061	909	796	707	637	522								
6	Vc	60	69	68	65	66	69	72	68	68								
	fz	0.021	0.03	0.053	0.069	0.063	0.069	0.074	0.087	0.106								
	RPM	3183	2745	2165	1724	1501	1373	1273	1082	866								
7	Vc	43	51	47	49	48	48	50	48	47								
	fz	0.018	0.028	0.046	0.063	0.061	0.069	0.075	0.086	0.107								
	RPM	2281	2029	1496	1300	1091	955	884	764	598								
8-9	Vc	35	38	40	40	40	40	40	40	41								
	fz	0.02	0.03	0.045	0.061	0.057	0.066	0.073	0.081	0.1								
	RPM	1857	1512	1273	1061	909	796	707	637	522								
10	Vc	60	69	68	65	66	69	72	68	68								
	fz	0.021	0.03	0.053	0.069	0.063	0.069	0.074	0.087	0.106								
	RPM	3183	2745	2165	1724	1501	1373	1273	1082	866								
11.1	Vc	35	38	40	40	40	40	40	40	41								
	fz	0.02	0.03	0.045	0.061	0.057	0.066	0.073	0.081	0.1								
	RPM	1857	1512	1273	1061	909	796	707	637	522								
11.2	Vc	25	27	28	28	28	28	28	28	28								
	fz	0.02	0.029	0.044	0.06	0.056	0.065	0.072	0.08	0.1								
	RPM	1326	1074	891	743	637	557	495	446	357								
M	14.1	Stainless steel	0.5D	1.5D	Vc	39	43	43	43	44	45	44	44					
					fz	0.019	0.03	0.045	0.064	0.059	0.069	0.075	0.084	0.104				
					RPM	2069	1711	1369	1141	1000	855	796	700	560				
K	15-20	Grey cast iron Nodular cast iron Malleable cast iron	0.5D	1.5D	Vc	60	69	68	65	66	69	72	68	68				
					fz	0.021	0.03	0.053	0.069	0.063	0.069	0.074	0.087	0.106				
					RPM	3183	2745	2165	1724	1501	1373	1273	1082	866				
H	40	Chilled Cast Iron	0.3D	1.5D	Vc	25	27	28	28	28	28	28	28	28				
					fz	0.02	0.029	0.044	0.06	0.056	0.065	0.072	0.08	0.1				
					RPM	1326	1074	891	743	637	557	495	446	357				

ISO	VDI 3323	Material Description	Ae	Ap	Parameter	Diameter (Ø)												
						6.0	8.0	10.0	12.0	14.0	16.0	18.0	20.0	25.0				
P	1	Non-alloy steel	0.5D	1.5D	Vc	63	72	72	72	74	72	71	72	75				
					fz	0.027	0.041	0.055	0.065	0.074	0.087	0.099	0.111	0.105				
					RPM	3342	2865	2292	1910	1682	1432	1256	1146	955				
	2		Vc	50	57	57	54	55	57	61	57	57						
			fz	0.027	0.04	0.053	0.069	0.078	0.087	0.092	0.109	0.106						
			RPM	2653	2268	1814	1432	1251	1134	1079	907	726						
	3-4		Vc	36	42	40	41	40	40	41	40	39						
			fz	0.024	0.038	0.047	0.064	0.076	0.087	0.094	0.107	0.106						
			RPM	1910	1671	1273	1088	909	796	725	637	497						
	5		Vc	29	32	34	34	33	33	33	33	34						
			fz	0.027	0.04	0.044	0.06	0.071	0.081	0.091	0.101	0.1						
RPM		1538	1273	1082	902	750	657	584	525	433								
6	Vc	50	57	57	54	55	57	61	57	57								
	fz	0.027	0.04	0.053	0.069	0.078	0.087	0.092	0.109	0.106								
	RPM	2653	2268	1814	1432	1251	1134	1079	907	726								
7	Vc	36	42	40	41	40	40	41	40	39								
	fz	0.024	0.038	0.047	0.064	0.076	0.087	0.094	0.107	0.106								
	RPM	1910	1671	1273	1088	909	796	725	637	497								
8-9	Vc	29	32	34	34	33	33	33	33	34								
	fz	0.027	0.04	0.044	0.06	0.071	0.081	0.091	0.101	0.1								
	RPM	1538	1273	1082	902	750	657	584	525	433								
10	Vc	50	57	57	54	55	57	61	57	57								
	fz	0.027	0.04	0.053	0.069	0.078	0.087	0.092	0.109	0.106								
	RPM	2653	2268	1814	1432	1251	1134	1079	907	726								
11.1	Vc	29	32	34	34	33	33	33	33	34								
	fz	0.027	0.04	0.044	0.06	0.071	0.081	0.091	0.101	0.1								
	RPM	1538	1273	1082	902	750	657	584	525	433								
11.2	Vc	21	22	24	23	23	23	23	23	24								
	fz	0.028	0.04	0.045	0.06	0.071	0.082	0.091	0.101	0.1								
	RPM	1114	875	764	610	523	458	407	366	306								
M	14.1	Stainless steel	0.5D	1.5D	Vc	33	36	36	36	37	36	37	36	37				
					fz	0.025	0.039	0.045	0.064	0.074	0.085	0.093	0.106	0.102				
					RPM	1751	1432	1146	955	841	716	654	573	471				
K	15-20	Grey cast iron Nodular cast iron Malleable cast iron	0.5D	1.5D	Vc	50	57	57	54	55	57	61	57	57				
					fz	0.027	0.04	0.053	0.069	0.078	0.087	0.092	0.109	0.106				
					RPM	2653	2268	1814	1432	1251	1134	1079	907	726				
H	40	Chilled Cast Iron	0.3D	1.5D	Vc	21	22	24	23	23	23	23	23	24				
					fz	0.028	0.04	0.045	0.06	0.071	0.082	0.091	0.101	0.1				
					RPM	1114	875	764	610	523	458	407	366	306				

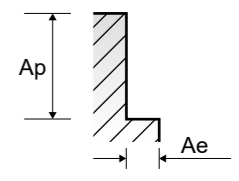
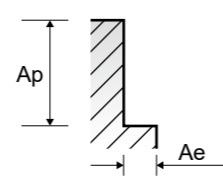



Global Cutting Tool Leader **YG-1**



MILLING



Leading Through Innovation



HSS-PM

TANK-POWER END MILLS

TANK - POWER HSS-PM - Fräser

- High Toughness for Stainless Steels, Carbon steels and Alloy Steels
- Hohe Zähigkeit, für rostfreie Stähle, Kohlenstoffstähle und legierte Stähle

SELECTION GUIDE

HSS

HSS



SERIES	E9940 GA940	E9A32 GAA32	E9936 GA936	E9A29 GAA29
FLUTE	2	2	2	2
HELIX ANGLE	30°	30°	30°	30°
CUTTING EDGE SHAPE	BALL NOSE	BALL NOSE	SQUARE	SQUARE
SIZE MIN	R0.5	R1.0	D1.0	D1.0
SIZE MAX	R12.5	R12.5	D25.0	D25.0
PAGE	C608	C609	C610	C611

HSS-PM

TANK-POWER END MILLS

High Toughness, for Stainless Steels, Carbon steels, Alloy Steels For General Application, Rough & Finish

◎ : Excellent ○ : Good

Recommended cutting conditions : p. C622

ISO	VDI 3323	Material Description	Composition / Structure / Heat Treatment	HB	HRc	E9942 GA942	E9A30 GAA30	E9938 GA938	E9A31 GAA31	E9941 GA941	E9A35 GAA35	E9A26 GAA26	E9A33 GAA33	E9A34 GAA34	E9E43 GAE43	
P	1	Non-alloy steel	About 0.15% C Annealed	125		◎	◎	◎	◎	◎	◎	◎	◎	◎	◎	
	2		About 0.45% C Annealed	190	13	◎	◎	◎	◎	◎	◎	◎	◎	◎	◎	
	3		About 0.45% C Quenched & Tempered	250	25	◎	◎	◎	◎	◎	◎	◎	◎	◎	◎	
	4		About 0.75% C Annealed	270	28	◎	◎	◎	◎	◎	◎	◎	◎	◎	◎	
	5		About 0.75% C Quenched & Tempered	300	32	◎	◎	◎	◎	◎	◎	◎	◎	◎	◎	
	6	Low alloy steel	Annealed	180	10	◎	◎	◎	◎	◎	◎	◎	◎	◎	◎	
	7		Quenched & Tempered	275	29	◎	◎	◎	◎	◎	◎	◎	◎	◎	◎	
	8		Quenched & Tempered	300	32	◎	◎	◎	◎	◎	◎	◎	◎	◎	◎	
	9		Quenched & Tempered	350	38	○	○	○	○	○	○	○	○	○	○	
	10		High alloyed steel, and tool steel	Annealed	200	15	◎	◎	◎	◎	◎	◎	◎	◎	◎	◎
	11		Quenched & Tempered	325	35	○	○	○	○	○	○	○	○	○	○	
M	12	Stainless steel	Ferritic / Martensitic Annealed	200	15	◎	◎	◎	◎	◎	◎	◎	◎	◎	◎	
	13		Martensitic Quenched & Tempered	240	23	◎	◎	◎	◎	◎	◎	◎	◎	◎	◎	
	14		Austenitic	180	10	◎	◎	◎	◎	◎	◎	◎	◎	◎	◎	
K	15	Grey cast iron	Pearlitic / ferritic	180	10	◎	◎	◎	◎	◎	◎	◎	◎	◎	◎	
	16		Pearlitic (Martensitic)	260	26	◎	◎	◎	◎	◎	◎	◎	◎	◎	◎	
	17	Nodular cast iron	Ferritic	160	3	◎	◎	◎	◎	◎	◎	◎	◎	◎	◎	
	18		Pearlitic	250	25	◎	◎	◎	◎	◎	◎	◎	◎	◎	◎	
	19	Malleable cast iron	Ferritic	130		◎	◎	◎	◎	◎	◎	◎	◎	◎	◎	
	20		Pearlitic	230	21	◎	◎	◎	◎	◎	◎	◎	◎	◎	◎	
N	21	Aluminum-wrought alloy	Not Curable	60												
	22		Curable Hardened	100												
	23	Aluminum-cast, alloyed	≤ 12% Si, Not Curable	75												
	24		≤ 12% Si, Curable Hardened	90												
	25		> 12% Si, Not Curable	130												
	26	Copper and Copper Alloys (Bronze / Brass)	Cutting Alloys, PB>1%	110		○	○	○	○	○	○	○	○	○	○	
	27		CuZn, CuSnZn (Brass)	90		○	○	○	○	○	○	○	○	○	○	
	28		CuSn, lead-free copper and electrolytic copper	100		○	○	○	○	○	○	○	○	○	○	
	29	Non Metallic Materials	Duroplastic, Fiber Reinforced Plastic													
	30		Rubber, Wood, etc.													
S	31	Heat Resistant Super Alloys	Fe Based	Annealed	200	15										
	32			Cured	280	30										
	33		Ni or Co Based	Annealed	250	25										
	34			Cured	350	38										
	35			Cast	320	34										
	36	Titanium Alloys	Pure Titanium	400 Rm												
37	Alpha + Beta Alloys		Hardened	1050 Rm												
H	38	Hardened steel	Hardened	550	55											
	39		Hardened	630	60											
	40	Chilled Cast Iron	Cast	400	42											
	41		Hardened	550	55											

E9942 GA942	E9A30 GAA30	E9938 GA938	E9A31 GAA31	E9941 GA941	E9A35 GAA35	E9A26 GAA26	E9A33 GAA33	E9A34 GAA34	E9E43 GAE43
3	3	4	4	Multi Flute	Multi Flute	Multi Flute	Multi Flute	Multi Flute	Multi Flute
30°	30°	30°	30°	30°	30°	45°	30°	30°	30°
SQUARE	SQUARE	SQUARE	SQUARE	ROUGHING	ROUGHING	ROUGHING	ROUGHING	ROUGHING	ROUGHING
D1.0	D1.0	D1.0	D2.0	D6.0	D6.0	D4.0	D6.0	D6.0	D10.0
D25.0	D25.0	D25.0	D25.0	D25.0	D25.0	D25.0	D25.0	D25.0	D25.0
C612	C613	C614	C615	C616	C617	C618	C619	C620	C621
STUB LENGTH	SHORT LENGTH	SHORT LENGTH	LONG LENGTH	SHORT LENGTH	LONG LENGTH	SHORT LENGTH	SHORT LENGTH	LONG LENGTH	WITH NECK
TiAIN	TiAIN	TiAIN	TiAIN	X-Coating	X-Coating	X-Coating	X-Coating	X-Coating	X-Coating



UNCOATED **E9940** SERIES
 TiAIN COATED **GA940** SERIES

HSS-PM, 2 FLUTE SHORT LENGTH BALL NOSE

● HSS-PM, 2 SCHNEIDEN KURZ STIRNRADIUS
 ○ FRAISES HSS-PM, 2 DENTS À BOUT HÉMISPHERIQUE, SÉRIE COURTE
 ○ 2 TAGLIENTI, SERIE CORTA, HSS-PM, SEMISFERICA

- ▶ Designed to machine carbon steels, alloyed steels, stainless steels.
- ▶ Designed for milling of radius bottom slots, fillets and special contours.
- ▶ YG-1's new developed TANK-POWER Coating suitable for high speed cutting.
- ▶ Geeignet zum Fräsen von Stahl, legiertem Stahl und rostfreier Stahl.
- ▶ Entworfen zum Fräsen von Nuten mit Radien, Rippen und speziellen Konturen.
- ▶ Neuentwickelte Beschichtung für Hochgeschwindigkeitsfräsen.



HSS PM DIN 327 2 30° ±0.02
 UNCOATED TiAIN p.C622-623

Flat Shank	Page	Plain Shank	Page
END MILL HOLDER D118-137		POWER MILLING CHUCK D161-176	
		ER COLLET CHUCK D73-116	
		SK SLIM CHUCK D183-201	

Unit : mm

EDP No.	Radius of Ball Nose		Mill Diameter	Shank Diameter	Length of Cut	Overall Length	
	UNCOATED	TiAIN					
E9940010		GA940010	R0.5	1.0	6	2.5	47
E9940020		GA940020	R1.0	2.0	6	4	48
E9940030		GA940030	R1.5	3.0	6	5	49
E9940040		GA940040	R2.0	4.0	6	7	51
E9940050		GA940050	R2.5	5.0	6	8	52
E9940060		GA940060	R3.0	6.0	6	8	52
E9940070		GA940070	R3.5	7.0	10	10	60
E9940080		GA940080	R4.0	8.0	10	11	61
E9940090		GA940090	R4.5	9.0	10	11	61
E9940100		GA940100	R5.0	10.0	10	13	63
E9940120		GA940120	R6.0	12.0	12	16	73
E9940140		GA940140	R7.0	14.0	12	16	73
E9940160		GA940160	R8.0	16.0	16	19	79
E9940180		GA940180	R9.0	18.0	16	19	79
E9940200		GA940200	R10.0	20.0	20	22	88
E9940220		GA940220	R11.0	22.0	20	22	88
E9940250		GA940250	R12.5	25.0	25	26	102

Mill Dia. Tolerance (mm)	Shank Dia. Tolerance
0 ~ - 0.03	h6

◎ : Excellent ○ : Good

ISO Material Description	P										M				K					
	Non-alloy steel					Low alloy steel					High alloyed steel, and tool steel		Stainless steel		Grey cast iron	Nodular cast iron		Malleable cast iron		
VDI 3323	1	2	3	4	5	6	7	8	9	10	11	12	13	14	15	16	17	18	19	20
HRc	13	25	28	32	30	10	29	32	38	15	35	15	23	10	10	26	3	25	21	21
HB	125	190	250	270	300	180	275	300	350	200	325	200	240	180	180	260	160	250	130	230
Recommend	◎	◎	◎	◎	◎	◎	◎	◎	◎	◎	◎	◎	◎	◎	◎	◎	◎	◎	◎	◎

ISO Material Description	N					S					H										
	Aluminum-wrought alloy		Aluminum-cast, alloyed			Copper and Copper Alloys (Bronze / Brass)		Non Metallic Materials			Heat Resistant Super Alloys					Titanium Alloys		Hardened steel	Chilled Cast Iron	Hardened Cast Iron	
VDI 3323	21	22	23	24	25	26	27	28	29	30	31	32	33	34	35	36	37	38	39	40	41
HRc											15	30	25	38	34			55	60	42	55
HB	60	100	75	90	130	110	90	100			200	280	250	350	320	400 Rm	1050 Rm	550	630	400	550
Recommend						○	○	○													



UNCOATED **E9A32** SERIES
 TiAIN COATED **GAA32** SERIES

HSS-PM, 2 FLUTE LONG LENGTH BALL NOSE

● HSS-PM, 2 SCHNEIDEN LANG STIRNRADIUS
 ○ FRAISES HSS-PM, 2 DENTS À BOUT HÉMISPHERIQUE, SÉRIE LONGUE
 ○ 2 TAGLIENTI, SERIE LUNGA, HSS-PM, SEMISFERICA

- ▶ Designed to machine carbon steels, alloyed steels, stainless steels.
- ▶ Designed for milling of radius bottom slots, fillets and special contours.
- ▶ YG-1's new developed TANK-POWER Coating suitable for high speed cutting.
- ▶ Geeignet zum Fräsen von Stahl, legiertem Stahl und rostfreier Stahl.
- ▶ Entworfen zum Fräsen von Nuten mit Radien, Rippen und speziellen Konturen.
- ▶ Neuentwickelte Beschichtung für Hochgeschwindigkeitsfräsen.



HSS PM DIN 1889 2 30° ±0.02
 UNCOATED TiAIN p.C622-623

Flat Shank	Page	Plain Shank	Page
END MILL HOLDER D118-137		POWER MILLING CHUCK D161-176	
		ER COLLET CHUCK D73-116	
		SK SLIM CHUCK D183-201	

Unit : mm

EDP No.	Radius of Ball Nose		Mill Diameter	Shank Diameter	Length of Cut	Overall Length	
	UNCOATED	TiAIN					
E9A32020		GAA32020	R1.0	2.0	6	7	54
E9A32030		GAA32030	R1.5	3.0	6	8	56
E9A32040		GAA32040	R2.0	4.0	6	11	63
E9A32050		GAA32050	R2.5	5.0	6	13	68
E9A32060		GAA32060	R3.0	6.0	6	13	68
E9A32070		GAA32070	R3.5	7.0	10	16	80
E9A32080		GAA32080	R4.0	8.0	10	19	88
E9A32090		GAA32090	R4.5	9.0	10	19	88
E9A32100		GAA32100	R5.0	10.0	10	22	95
E9A32120		GAA32120	R6.0	12.0	12	26	110
E9A32140		GAA32140	R7.0	14.0	12	26	110
E9A32160		GAA32160	R8.0	16.0	16	32	123
E9A32180		GAA32180	R9.0	18.0	16	32	123
E9A32200		GAA32200	R10.0	20.0	20	38	141
E9A32220		GAA32220	R11.0	22.0	20	38	141
E9A32250		GAA32250	R12.5	25.0	25	45	166

Mill Dia. Tolerance (mm)	Shank Dia. Tolerance
0 ~ - 0.03	h6

◎ : Excellent ○ : Good

ISO Material Description	P										M				K					
	Non-alloy steel					Low alloy steel					High alloyed steel, and tool steel		Stainless steel		Grey cast iron	Nodular cast iron		Malleable cast iron		
VDI 3323	1	2	3	4	5	6	7	8	9	10	11	12	13	14	15	16	17	18	19	20
HRc	13	25	28	32	30	10	29	32	38	15	35	15	23	10	10	26	3	25	21	21
HB	125	190	250	270	300	180	275	300	350	200	325	200	240	180	180	260	160	250	130	230
Recommend	◎	◎	◎	◎	◎	◎	◎	◎	◎	◎	◎	◎	◎	◎	◎	◎	◎	◎	◎	◎

ISO Material Description	N					S					H										
	Aluminum-wrought alloy		Aluminum-cast, alloyed			Copper and Copper Alloys (Bronze / Brass)		Non Metallic Materials			Heat Resistant Super Alloys					Titanium Alloys		Hardened steel	Chilled Cast Iron	Hardened Cast Iron	
VDI 3323	21	22	23	24	25	26	27	28	29	30	31	32	33	34	35	36	37	38	39	40	41
HRc											15	30	25	38	34			55	60	42	55
HB	60	100	75	90	130	110	90	100			200	280	250	350	320	400 Rm	1050 Rm	550	630	400	550
Recommend						○	○	○													



UNCOATED **E9936** SERIES

TiAIN COATED **GA936** SERIES

HSS-PM, 2 FLUTE SHORT LENGTH

- HSS-PM, 2 SCHNEIDEN KURZ
- FRAISES HSS-PM, 2 DENTS, SÉRIE COURTE
- 2 TAGLIENTI, SERIE CORTA, HSS-PM

- ▶ Designed to machine carbon steels, alloyed steels, stainless steels.
- ▶ 2 Flute design for slotting.
- ▶ Suitable for high speed cutting of difficult-to-cut materials.
- ▶ YG-1's new developed TANK-POWER Coating suitable for high speed cutting.
- ▶ Geeignet zum Fräsen von Stahl, legiertem Stahl und rostfreier Stahl.
- ▶ 2 Schneiden, Geeignet für Nutenfräsen.
- ▶ Geeignet für Hochgeschwindigkeitsfräsen von schwer zu zerspanenden Materialien.
- ▶ Neuentwickelte Beschichtung für Hochgeschwindigkeitsfräsen.

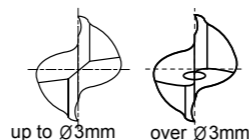

Flat Shank	Page	Plain Shank	Page
END MILL HOLDER	D118 - 137	POWER MILLING CHUCK	D161 - 176
ER COLLET CHUCK	-	ER COLLET CHUCK	D73 - 116
SK SLIM CHUCK	-	SK SLIM CHUCK	D183 - 201

Unit : mm

EDP No.	Mill Diameter		Shank Diameter	Length of Cut	Overall Length
	UNCOATED	TiAIN			
E9936010	1.0	1.0	6	2.5	47
E9936020	2.0	2.0	6	4	48
E9936030	3.0	3.0	6	5	49
E9936040	4.0	4.0	6	7	51
E9936050	5.0	5.0	6	8	52
E9936060	6.0	6.0	6	8	52
E9936070	7.0	7.0	10	10	60
E9936080	8.0	8.0	10	11	61
E9936090	9.0	9.0	10	11	61
E9936100	10.0	10.0	10	13	63
E9936120	12.0	12.0	12	16	73
E9936140	14.0	14.0	12	16	73
E9936160	16.0	16.0	16	19	79
E9936180	18.0	18.0	16	19	79
E9936200	20.0	20.0	20	22	88
E9936220	22.0	22.0	20	22	88
E9936250	25.0	25.0	25	26	102

Tolerances according to DIN 7160 & 7161

	Tolerance range in μ m				
	Nominal-Diameter in mm				
	from 1 to 3	over 3 to 6	over 6 to 10	over 10 to 18	over 18 to 30
e8	- 14 - 28	- 20 - 38	- 25 - 47	- 32 - 59	- 40 - 73
h6	0 - 6	0 - 8	0 - 9	0 - 11	0 - 13

◎ : Excellent ○ : Good

ISO	P										M				K					
	Non-alloy steel					Low alloy steel					High alloyed steel, and tool steel		Stainless steel		Grey cast iron		Nodular cast iron		Malleable cast iron	
Material Description	1	2	3	4	5	6	7	8	9	10	11	12	13	14	15	16	17	18	19	20
VDI 3323	1	2	3	4	5	6	7	8	9	10	11	12	13	14	15	16	17	18	19	20
HRc	13	25	28	32	38	42	48	52	58	62	68	72	78	82	88	92	98	102	108	112
HB	125	190	250	270	300	350	380	420	480	520	580	620	680	720	780	820	880	920	980	1020
Recommend	◎	◎	◎	◎	◎	◎	◎	◎	◎	◎	◎	◎	◎	◎	◎	◎	◎	◎	◎	◎



UNCOATED **E9A29** SERIES

TiAIN COATED **GAA29** SERIES

HSS-PM, 2 FLUTE LONG LENGTH

- HSS-PM, 2 SCHNEIDEN LANG
- FRAISES HSS-PM, 2 DENTS, SÉRIE LONGUE
- 2 TAGLIENTI, SERIE LUNGA, HSS-PM

- ▶ Designed to machine carbon steels, alloyed steels, stainless steels.
- ▶ 2 Flute design for slotting.
- ▶ Suitable for high speed cutting of difficult-to-cut materials.
- ▶ YG-1's new developed TANK-POWER Coating suitable for high speed cutting.
- ▶ Geeignet zum Fräsen von Stahl, legiertem Stahl und rostfreier Stahl.
- ▶ 2 Schneiden, Geeignet für Nutenfräsen.
- ▶ Geeignet für Hochgeschwindigkeitsfräsen von schwer zu zerspanenden Materialien.
- ▶ Neuentwickelte Beschichtung für Hochgeschwindigkeitsfräsen.

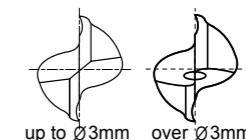

Flat Shank	Page	Plain Shank	Page
END MILL HOLDER	D118 - 137	POWER MILLING CHUCK	D161 - 176
ER COLLET CHUCK	-	ER COLLET CHUCK	D73 - 116
SK SLIM CHUCK	-	SK SLIM CHUCK	D183 - 201

Unit : mm

EDP No.	Mill Diameter		Shank Diameter	Length of Cut	Overall Length
	UNCOATED	TiAIN			
E9A29010	1.0	1.0	6	3	47
E9A29020	2.0	2.0	6	7	51
E9A29030	3.0	3.0	6	8	52
E9A29040	4.0	4.0	6	11	55
E9A29050	5.0	5.0	6	13	57
E9A29060	6.0	6.0	6	13	57
E9A29070	7.0	7.0	10	16	66
E9A29080	8.0	8.0	10	19	69
E9A29090	9.0	9.0	10	19	69
E9A29100	10.0	10.0	10	22	72
E9A29120	12.0	12.0	12	26	83
E9A29140	14.0	14.0	12	26	83
E9A29160	16.0	16.0	16	32	92
E9A29180	18.0	18.0	16	32	92
E9A29200	20.0	20.0	20	38	104
E9A29220	22.0	22.0	20	38	104
E9A29250	25.0	25.0	25	45	121

Tolerances according to DIN 7160 & 7161

	Tolerance range in μ m				
	Nominal-Diameter in mm				
	from 1 to 3	over 3 to 6	over 6 to 10	over 10 to 18	over 18 to 30
e8	- 14 - 28	- 20 - 38	- 25 - 47	- 32 - 59	- 40 - 73
h6	0 - 6	0 - 8	0 - 9	0 - 11	0 - 13

◎ : Excellent ○ : Good

ISO	P										M				K					
	Non-alloy steel					Low alloy steel					High alloyed steel, and tool steel		Stainless steel		Grey cast iron		Nodular cast iron		Malleable cast iron	
Material Description	1	2	3	4	5	6	7	8	9	10	11	12	13	14	15	16	17	18	19	20
VDI 3323	1	2	3	4	5	6	7	8	9	10	11	12	13	14	15	16	17	18	19	20
HRc	13	25	28	32	38	42	48	52	58	62	68	72	78	82	88	92	98	102	108	112
HB	125	190	250	270	300	350	380	420	480	520	580	620	680	720	780	820	880	920	980	1020
Recommend	◎	◎	◎	◎	◎	◎	◎	◎	◎	◎	◎	◎	◎	◎	◎	◎	◎	◎	◎	◎



UNCOATED **E9942** SERIES
TiAIN COATED **GA942** SERIES

HSS-PM, 3 FLUTE STUB LENGTH

- HSS-PM, 3 SCHNEIDEN EXTRA KURZ
- () FRAISES HSS-PM, 3 DENTS, SÉRIE EXTRA-COURTE
- () 3 TAGLIENTI, SERIE EXTRA CORTA, HSS-PM

- ▶ Designed to machine carbon steels, alloyed steels, stainless steels.
- ▶ Well balanced web design to minimize deflection and chattering.
- ▶ 3 flute design possess the advantage of 2 flute and 4 flute end mill.
- ▶ YG-1's new developed TANK-POWER Coating suitable for high speed cutting.

- ▶ Geeignet zum Fräsen von Stahl, legiertem Stahl und rostfreier Stahl.
- ▶ Verstärkter Kern zur Erhöhung der Stabilität.
- ▶ 3 Schneiden Design besitzt die Vorteile von 2-bzw 4 Schneiden Fräsem.
- ▶ Neuentwickelte Beschichtung für Hochgeschwindigkeitsfräsen.

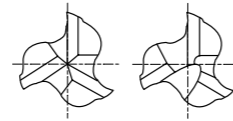

up to Ø1mm over Ø1mm



Flat Shank	Page	Plain Shank	Page
END MILL HOLDER	D118 - 137	POWER MILLING CHUCK	D161 - 176
		ER COLLET CHUCK	D73 - 116
		SK SLIM CHUCK	D183 - 201

Unit : mm

EDP No.	Mill Diameter		Shank Diameter		Length of Cut	Overall Length
	UNCOATED	TiAIN	e8	h6		
E9942010		GA942010	1.0	6	2.5	47
E9942020		GA942020	2.0	6	4	48
E9942030		GA942030	3.0	6	5	49
E9942040		GA942040	4.0	6	7	51
E9942050		GA942050	5.0	6	8	52
E9942060		GA942060	6.0	6	8	52
E9942070		GA942070	7.0	10	10	60
E9942080		GA942080	8.0	10	11	61
E9942090		GA942090	9.0	10	11	61
E9942100		GA942100	10.0	10	13	63
E9942120		GA942120	12.0	12	16	73
E9942140		GA942140	14.0	12	16	73
E9942160		GA942160	16.0	16	19	79
E9942180		GA942180	18.0	16	19	79
E9942200		GA942200	20.0	20	22	88
E9942220		GA942220	22.0	20	22	88
E9942250		GA942250	25.0	25	26	102

Tolerances according to DIN 7160 & 7161

	Tolerance range in μm				
	Nominal-Diameter in mm				
	from 1 to 3	over 3 to 6	over 6 to 10	over 10 to 18	over 18 to 30
e8	- 14 - 28	- 20 - 38	- 25 - 47	- 32 - 59	- 40 - 73
h6	0 - 6	0 - 8	0 - 9	0 - 11	0 - 13

◎ : Excellent ○ : Good

ISO	P										M				K					
	Non-alloy steel					Low alloy steel					High alloyed steel, and tool steel		Stainless steel		Grey cast iron	Nodular cast iron		Malleable cast iron		
Material Description	1	2	3	4	5	6	7	8	9	10	11	12	13	14	15	16	17	18	19	20
VDI 3323	1	2	3	4	5	6	7	8	9	10	11	12	13	14	15	16	17	18	19	20
HRc	13	25	28	32	32	30	29	32	38	15	35	15	23	10	10	26	3	25	10	21
HB	125	190	250	270	300	180	275	300	350	200	325	200	240	180	180	260	160	250	130	230
Recommend	◎	◎	◎	◎	◎	◎	◎	◎	◎	◎	◎	◎	◎	◎	◎	◎	◎	◎	◎	◎



UNCOATED **E9A30** SERIES
TiAIN COATED **GAA30** SERIES

HSS-PM, 3 FLUTE SHORT LENGTH

- HSS-PM, 3 SCHNEIDEN KURZ
- () FRAISES HSS-PM, 3 DENTS, SÉRIE COURTE
- () 3 TAGLIENTI, SERIE CORTA, HSS-PM

- ▶ Designed to machine carbon steels, alloyed steels, stainless steels.
- ▶ Well balanced web design to minimize deflection and chattering.
- ▶ 3 flute design possess the advantage of 2 flute and 4 flute end mill.
- ▶ YG-1's new developed TANK-POWER Coating suitable for high speed cutting.

- ▶ Geeignet zum Fräsen von Stahl, legiertem Stahl und rostfreier Stahl.
- ▶ Verstärkter Kern zur Erhöhung der Stabilität.
- ▶ 3 Schneiden Design besitzt die Vorteile von 2-bzw 4 Schneiden Fräsem.
- ▶ Neuentwickelte Beschichtung für Hochgeschwindigkeitsfräsen.

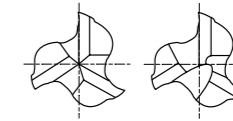

up to Ø1mm over Ø1mm



Flat Shank	Page	Plain Shank	Page
END MILL HOLDER	D118 - 137	POWER MILLING CHUCK	D161 - 176
		ER COLLET CHUCK	D73 - 116
		SK SLIM CHUCK	D183 - 201

Unit : mm

EDP No.	Mill Diameter		Shank Diameter		Length of Cut	Overall Length
	UNCOATED	TiAIN	e8	h6		
E9A30010		GAA30010	1.0	6	3	47
E9A30020		GAA30020	2.0	6	7	51
E9A30030		GAA30030	3.0	6	8	52
E9A30040		GAA30040	4.0	6	11	55
E9A30050		GAA30050	5.0	6	13	57
E9A30060		GAA30060	6.0	6	13	57
E9A30070		GAA30070	7.0	10	16	66
E9A30080		GAA30080	8.0	10	19	69
E9A30090		GAA30090	9.0	10	19	69
E9A30100		GAA30100	10.0	10	22	72
E9A30120		GAA30120	12.0	12	26	83
E9A30140		GAA30140	14.0	12	26	83
E9A30160		GAA30160	16.0	16	32	92
E9A30180		GAA30180	18.0	16	32	92
E9A30200		GAA30200	20.0	20	38	104
E9A30220		GAA30220	22.0	20	38	104
E9A30250		GAA30250	25.0	25	45	121

Tolerances according to DIN 7160 & 7161

	Tolerance range in μm				
	Nominal-Diameter in mm				
	from 1 to 3	over 3 to 6	over 6 to 10	over 10 to 18	over 18 to 30
e8	- 14 - 28	- 20 - 38	- 25 - 47	- 32 - 59	- 40 - 73
h6	0 - 6	0 - 8	0 - 9	0 - 11	0 - 13

◎ : Excellent ○ : Good

ISO	P										M				K					
	Non-alloy steel					Low alloy steel					High alloyed steel, and tool steel		Stainless steel		Grey cast iron	Nodular cast iron		Malleable cast iron		
Material Description	1	2	3	4	5	6	7	8	9	10	11	12	13	14	15	16	17	18	19	20
VDI 3323	1	2	3	4	5	6	7	8	9	10	11	12	13	14	15	16	17	18	19	20
HRc	13	25	28	32	32	30	29	32	38	15	35	15	23	10	10	26	3	25	10	21
HB	125	190	250	270	300	180	275	300	350	200	325	200	240	180	180	260	160	250	130	230
Recommend	◎	◎	◎	◎	◎	◎	◎	◎	◎	◎	◎	◎	◎	◎	◎	◎	◎	◎	◎	◎



UNCOATED **E9938** SERIES
 TiAIN COATED **GA938** SERIES

HSS-PM, 4 FLUTE SHORT LENGTH

- HSS-PM, 4 SCHNEIDEN KURZ
- (●) FRAISES HSS-PM, 4 DENTS, SÉRIE COURTE
- (●) 4 TAGLIENTI, SERIE CORTA, HSS-PM

- ▶ Designed to machine carbon steels, alloyed steels, stainless steels.
- ▶ Recommended for pocketing, cam milling, die sinking and slotting.
- ▶ Designed for high speed cutting of difficult-to-cut materials.
- ▶ YG-1's new developed TANK-POWER Coating suitable for high speed cutting.

- ▶ Geeignet zum Fräsen von Stahl, legiertem Stahl und rostfreier Stahl.
- ▶ Empfohlen für Taschenfräsen, Nockenfräsen, Gussformen und Nutenfräsen.
- ▶ Geeignet für Hochgeschwindigkeitsfräsen von schwer zu zerspanenden Materialien.
- ▶ Neuentwickelte Beschichtung für Hochgeschwindigkeitsfräsen.

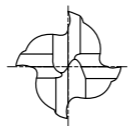

	Flat Shank	Page	Plain Shank	Page
END MILL HOLDER	D118-137	-	POWER MILLING CHUCK	D161-176
ER COLLET CHUCK	-	-	D73-116	-
SK SLIM CHUCK	-	-	D183-201	-

Unit : mm

EDP No.	Mill Diameter		Shank Diameter	Length of Cut	Overall Length
	UNCOATED	TiAIN			
E9938010	E9938010	1.0	6	3	49
E9938020	E9938020	2.0	6	7	51
E9938030	E9938030	3.0	6	8	52
E9938040	E9938040	4.0	6	11	55
E9938050	E9938050	5.0	6	13	57
E9938060	E9938060	6.0	6	13	57
E9938070	E9938070	7.0	10	16	66
E9938080	E9938080	8.0	10	19	69
E9938090	E9938090	9.0	10	19	69
E9938100	E9938100	10.0	10	22	72
E9938120	E9938120	12.0	12	26	83
E9938140	E9938140	14.0	12	26	83
E9938160	E9938160	16.0	16	32	92
E9938180	E9938180	18.0	16	32	92
E9938200	E9938200	20.0	20	38	104
E9938220	E9938220	22.0	20	38	104
E9938250	E9938250	25.0	25	45	121

▶ Mill Diameter 1mm: Center match end teeth

Mill Dia. Tolerance (mm)	Shank Dia. Tolerance
0 ~ -0.03	h6

◎ : Excellent ○ : Good

ISO Material Description	P										M				K						
	Non-alloy steel					Low alloy steel					High alloyed steel, and tool steel		Stainless steel		Grey cast iron		Nodular cast iron		Malleable cast iron		
VDI 3323	1	2	3	4	5	6	7	8	9	10	11	12	13	14	15	16	17	18	19	20	
HRc	13	25	28	32	30	10	29	32	38	15	35	15	23	10	10	26	3	25	21	21	
HB	125	190	250	270	300	180	275	300	350	200	325	200	240	180	180	260	160	250	130	230	
Recommend	◎	◎	◎	◎	◎	◎	◎	◎	◎	◎	◎	◎	◎	◎	◎	◎	◎	◎	◎	◎	◎

ISO Material Description	N					S					H														
	Aluminum-wrought alloy		Aluminum-cast, alloyed			Copper and Copper Alloys (Bronze / Brass)		Non Metallic Materials			Heat Resistant Super Alloys					Titanium Alloys		Hardened steel		Chilled Cast Iron		Hardened Cast Iron			
VDI 3323	21	22	23	24	25	26	27	28	29	30	31	32	33	34	35	36	37	38	39	40	41	42	43	44	45
HRc	21	22	23	24	25	26	27	28	29	30	31	32	33	34	35	36	37	38	39	40	41	42	43	44	45
HB	60	100	75	90	130	110	90	100			200	280	250	350	320	400 Rm	1050 Rm	550	630	400	550				
Recommend						○	○	○																	



UNCOATED **E9A31** SERIES
 TiAIN COATED **GAA31** SERIES

HSS-PM, 4 FLUTE LONG LENGTH

- HSS-PM, 4 SCHNEIDEN LANG
- (●) FRAISES HSS-PM, 4 DENTS, SÉRIE LONGUE
- (●) 4 TAGLIENTI, SERIE LUNGA, HSS-PM

- ▶ Designed to machine carbon steels, alloyed steels, stainless steels.
- ▶ Recommended for pocketing, cam milling, die sinking and slotting.
- ▶ Designed for high speed cutting of difficult-to-cut materials.
- ▶ YG-1's new developed TANK-POWER Coating suitable for high speed cutting.

- ▶ Geeignet zum Fräsen von Stahl, legiertem Stahl und rostfreier Stahl.
- ▶ Empfohlen für Taschenfräsen, Nockenfräsen, Gussformen und Nutenfräsen.
- ▶ Geeignet für Hochgeschwindigkeitsfräsen von schwer zu zerspanenden Materialien.
- ▶ Neuentwickelte Beschichtung für Hochgeschwindigkeitsfräsen.

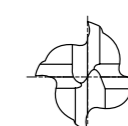

	Flat Shank	Page	Plain Shank	Page
END MILL HOLDER	D118-137	-	POWER MILLING CHUCK	D161-176
ER COLLET CHUCK	-	-	D73-116	-
SK SLIM CHUCK	-	-	D183-201	-

Unit : mm

EDP No.	Mill Diameter		Shank Diameter	Length of Cut	Overall Length
	UNCOATED	TiAIN			
E9A31020	E9A31020	2.0	6	10	54
E9A31030	E9A31030	3.0	6	12	56
E9A31040	E9A31040	4.0	6	19	63
E9A31050	E9A31050	5.0	6	24	68
E9A31060	E9A31060	6.0	6	24	68
E9A31070	E9A31070	7.0	10	30	80
E9A31080	E9A31080	8.0	10	38	88
E9A31090	E9A31090	9.0	10	38	88
E9A31100	E9A31100	10.0	10	45	95
E9A31120	E9A31120	12.0	12	53	110
E9A31140	E9A31140	14.0	12	53	110
E9A31160	E9A31160	16.0	16	63	123
E9A31180	E9A31180	18.0	16	63	123
E9A31200	E9A31200	20.0	20	75	141
E9A31220	E9A31220	22.0	20	75	141
E9A31250	E9A31250	25.0	25	90	166

Mill Dia. Tolerance (mm)	Shank Dia. Tolerance
0 ~ -0.03	h6

◎ : Excellent ○ : Good

ISO Material Description	P										M				K						
	Non-alloy steel					Low alloy steel					High alloyed steel, and tool steel		Stainless steel		Grey cast iron		Nodular cast iron		Malleable cast iron		
VDI 3323	1	2	3	4	5	6	7	8	9	10	11	12	13	14	15	16	17	18	19	20	
HRc	13	25	28	32	30	10	29	32	38	15	35	15	23	10	10	26	3	25	21	21	
HB	125	190	250	270	300	180	275	300	350	200	325	200	240	180	180	260	160	250	130	230	
Recommend	◎	◎	◎	◎	◎	◎	◎	◎	◎	◎	◎	◎	◎	◎	◎	◎	◎	◎	◎	◎	◎

ISO Material Description	N					S					H														
	Aluminum-wrought alloy		Aluminum-cast, alloyed			Copper and Copper Alloys (Bronze / Brass)		Non Metallic Materials			Heat Resistant Super Alloys					Titanium Alloys		Hardened steel		Chilled Cast Iron		Hardened Cast Iron			
VDI 3323	21	22	23	24	25	26	27	28	29	30	31	32	33	34	35	36	37	38	39	40	41	42	43	44	45
HRc	21	22	23	24	25	26	27	28	29	30	31	32	33	34	35	36	37	38	39	40	41	42	43	44	45
HB	60	100	75	90	130	110	90	100			200	280	250	350	320	400 Rm	1050 Rm	550	630	400	550				
Recommend						○	○	○																	

HSS-PM, MULTI FLUTE SHORT LENGTH ROUGHING - FINE

- HSS-PM, MULTI SCHNEIDEN KURZ SCHRUPPFRÄSER - FEIN
- FRAISES HSS-PM, MULTI-DENTS RAVAGEUSE - PAS FINS, SÉRIE COURTE
- MULTI TAGL., PER SGROSSATURA, SERIE CORTA, BOMBATO FINE - HSS PM

- Suitable for high-feed roughing milling.
- Designed to machine carbon steels, alloyed steels, stainless steels.
- Providing excellent finished surfaces in many cases.
- YG-1's new developed TANK-POWER Coating suitable for high speed cutting.
- up to Ø20 : center cut, over Ø20 : non center cut

- Geeignet zum HSC - Schrupp - Fräsen.
- Geeignet zum Fräsen von Stahl, legiertem Stahl und rostfreier Stahl.
- Liefert in vielen Fällen exzellente bearbeitete Oberflächen.
- Neuentwickelte Beschichtung für Hochgeschwindigkeitsfräsen.
- Bis D=20mm : Mit Zentrumschneide, über D=20mm : Ohne Zentrumschneide.

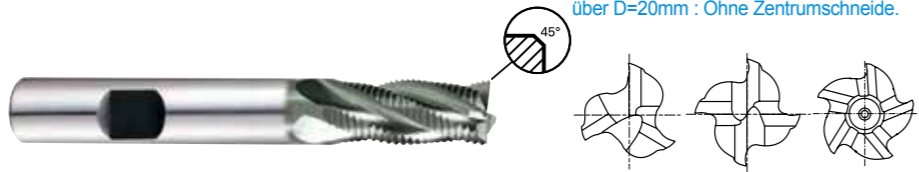

up to Ø9 Ø10 ~ Ø20 over Ø20

HSS PM **DIN 844** **HR** **3-5** **30°** **DIN 1835B**
 UNCOATED X Coating p.C632-633

Flat Shank	Page	Plain Shank	Page
END MILL HOLDER	D118-137	POWER MILLING CHUCK	D161-176
ER COLLET CHUCK	-	ER COLLET CHUCK	D73-116
SK SLIM CHUCK	-	SK SLIM CHUCK	D183-201

Unit : mm

EDP No.	Mill Diameter	Shank Diameter	Length of Cut	Overall Length	No. of Flute	Chamfer
E9941060	6.0	6	13	57	3	0.18
E9941070	7.0	10	16	66	3	0.18
E9941080	8.0	10	19	69	3	0.18
E9941090	9.0	10	19	69	3	0.18
E9941100	10.0	10	22	72	4	0.18
E9941120	12.0	12	26	83	4	0.18
E9941140	14.0	12	26	83	4	0.25
E9941160	16.0	16	32	92	4	0.25
E9941180	18.0	16	32	92	4	0.25
E9941200	20.0	20	38	104	4	0.25
E9941220	22.0	20	38	104	5	0.36
E9941250	25.0	25	45	121	5	0.36

Tolerances according to DIN 7160 & 7161

	Tolerance range in μm					
	Nominal-Diameter in mm					
	from 1 to 3	over 3 to 6	over 6 to 10	over 10 to 18	over 18 to 30	over 30 to 50
js12	± 50	± 60	± 75	± 90	± 105	± 125
h6	0 - 6	0 - 8	0 - 9	0 - 11	0 - 13	0 - 16

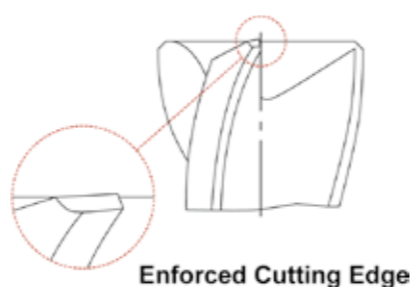

◎ : Excellent ○ : Good

ISO Material Description	P										M				K					
	Non-alloy steel					Low alloy steel					High alloyed steel, and tool steel		Stainless steel		Grey cast iron	Nodular cast iron		Malleable cast iron		
VDI 3323	1	2	3	4	5	6	7	8	9	10	11	12	13	14	15	16	17	18	19	20
HRc	13	25	28	32	35	38	42	45	48	52	55	58	62	65	68	72	75	78	82	85
HB	125	190	250	270	300	180	275	300	350	200	325	200	240	180	180	260	160	250	130	230
Recommend	◎	◎	◎	◎	◎	◎	◎	◎	◎	◎	◎	◎	◎	◎	◎	◎	◎	◎	◎	◎

HSS-PM, MULTI FLUTE LONG LENGTH ROUGHING - FINE

- HSS-PM, MULTI SCHNEIDEN LANG SCHRUPPFRÄSER - FEIN
- FRAISES HSS-PM, MULTI-DENTS RAVAGEUSE - PAS FINS, SÉRIE LONGUE
- MULTI TAGL., PER SGROSSATURA, SERIE LUNGA, BOMBATO FINE - HSS PM

- Suitable for high-feed roughing milling.
- Designed to machine carbon steels, alloyed steels, stainless steels.
- Providing excellent finished surfaces in many cases.
- YG-1's new developed TANK-POWER Coating suitable for high speed cutting.
- up to Ø20 : center cut, over Ø20 : non center cut

- Geeignet zum HSC - Schrupp - Fräsen.
- Geeignet zum Fräsen von Stahl, legiertem Stahl und rostfreier Stahl.
- Liefert in vielen Fällen exzellente bearbeitete Oberflächen.
- Neuentwickelte Beschichtung für Hochgeschwindigkeitsfräsen.
- Bis D=20mm : Mit Zentrumschneide, über D=20mm : Ohne Zentrumschneide.

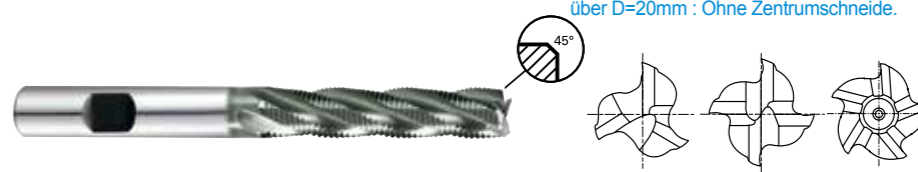

up to Ø9 Ø10 ~ Ø20 over Ø20

HSS PM **DIN 844** **HR** **3-5** **30°** **DIN 1835B**
 UNCOATED X Coating p.C632-633

Flat Shank	Page	Plain Shank	Page
END MILL HOLDER	D118-137	POWER MILLING CHUCK	D161-176
ER COLLET CHUCK	-	ER COLLET CHUCK	D73-116
SK SLIM CHUCK	-	SK SLIM CHUCK	D183-201

Unit : mm

EDP No.	Mill Diameter	Shank Diameter	Length of Cut	Overall Length	No. of Flute	Chamfer
E9A35060	6.0	6	24	68	3	0.18
E9A35070	7.0	10	30	80	3	0.18
E9A35080	8.0	10	38	88	3	0.18
E9A35090	9.0	10	38	88	3	0.18
E9A35100	10.0	10	45	95	4	0.18
E9A35120	12.0	12	53	110	4	0.18
E9A35140	14.0	12	53	110	4	0.25
E9A35160	16.0	16	63	123	4	0.25
E9A35180	18.0	16	63	123	4	0.25
E9A35200	20.0	20	75	141	4	0.25
E9A35220	22.0	20	75	141	5	0.36
E9A35250	25.0	25	90	166	5	0.36

Tolerances according to DIN 7160 & 7161

	Tolerance range in μm					
	Nominal-Diameter in mm					
	from 1 to 3	over 3 to 6	over 6 to 10	over 10 to 18	over 18 to 30	over 30 to 50
js12	± 50	± 60	± 75	± 90	± 105	± 125
h6	0 - 6	0 - 8	0 - 9	0 - 11	0 - 13	0 - 16

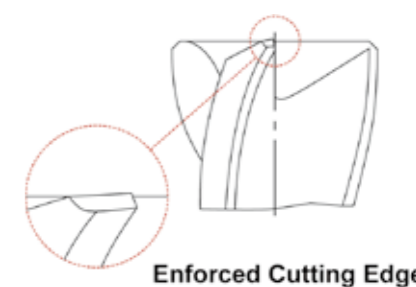

◎ : Excellent ○ : Good

ISO Material Description	P										M				K					
	Non-alloy steel					Low alloy steel					High alloyed steel, and tool steel		Stainless steel		Grey cast iron	Nodular cast iron		Malleable cast iron		
VDI 3323	1	2	3	4	5	6	7	8	9	10	11	12	13	14	15	16	17	18	19	20
HRc	13	25	28	32	35	38	42	45	48	52	55	58	62	65	68	72	75	78	82	85
HB	125	190	250	270	300	180	275	300	350	200	325	200	240	180	180	260	160	250	130	230
Recommend	◎	◎	◎	◎	◎	◎	◎	◎	◎	◎	◎	◎	◎	◎	◎	◎	◎	◎	◎	◎



UNCOATED **E9A26** SERIES
X-COATING **GAA26** SERIES

HSS-PM, MULTI FLUTE 45°HELIX SHORT LENGTH ROUGHING - FINE

- HSS-PM, MULTI SCHNEIDEN 45°RECHTSSPIRALE KURZ SCHRUPFRÄSER - FEIN
- FRAISES HSS-PM, MULTI-DENTS RAVAGEUSE HÉLICE À 45° - PAS FINS, SÉRIE COURTE
- MULTI TAGL., ELICA 45°, PER SGROS., SERIE CORTA, BOMBATO FINE - HSS PM

- ▶ High chip removal and minimizing breakages of cutting edges.
- ▶ Designed to machine carbon steels, alloyed steels, stainless steels
- ▶ YG-1's new developed TANK-POWER Coating suitable for high speed cutting
- ▶ Schnelle Spanabfuhr und Minimierung von Schneidkantenausbrüchen
- ▶ Geeignet zum Fräsen von Stahl, legiertem Stahl und rostfreier Stahl.
- ▶ Neuentwickelte Beschichtung für Hochgeschwindigkeitsfräsen.

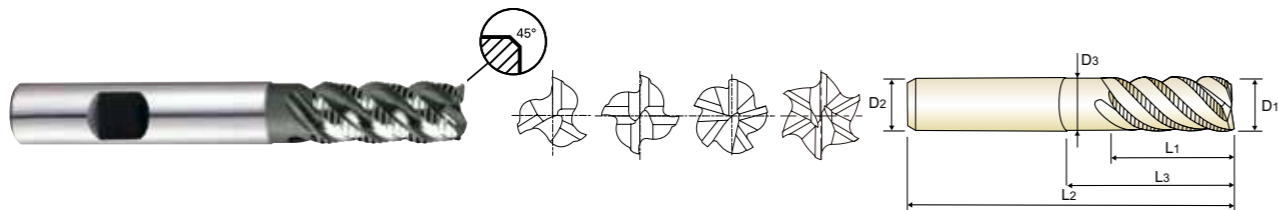

HSS PM, DIN 844, HR, 3-6, 45°, DIN 1835B, UNCOATED, X Coating, C x 45°, p.C634-635

Flat Shank	Page	Plain Shank	Page
END MILL HOLDER	D118-137	POWER MILLING CHUCK	D161-176
		ER COLLET CHUCK	D73-116
		SK SLIM CHUCK	D183-201

Unit : mm

EDP No.	Mill Diameter	Shank Diameter	Length of Cut	Length Below Shank	Overall Length	Neck Diameter	No. of Flute	Chamfer	
									UNCOATED
E9A26040	GAA26040	4.0	6	11	-	57	-	3	0.1
E9A26050	GAA26050	5.0	6	13	-	57	-	4	0.13
E9A26060	GAA26060	6.0	6	13	-	57	-	4	0.15
E9A26070	GAA26070	7.0	10	16	-	66	-	4	0.15
E9A26080	GAA26080	8.0	10	19	-	69	-	4	0.18
E9A26090	GAA26090	9.0	10	19	-	69	-	4	0.18
E9A26100	GAA26100	10.0	10	22	31	72	9.5	4	0.20
E9A26120	GAA26120	12.0	12	26	37	83	11.5	4	0.20
E9A26140	GAA26140	14.0	12	26	-	83	-	5	0.20
E9A26160	GAA26160	16.0	16	32	44	92	15	5	0.20
E9A26180	GAA26180	18.0	16	32	-	92	-	6	0.20
E9A26200	GAA26200	20.0	20	38	54	104	19	6	0.20
E9A26250	GAA26250	25.0	25	45	63	121	24	6	0.20

Tolerances according to DIN 7160 & 7161

	Tolerance range in μm					
	Nominal-Diameter in mm					
	from 1 to 3	over 3 to 6	over 6 to 10	over 10 to 18	over 18 to 30	over 30 to 50
js12	± 50	± 60	± 75	± 90	± 105	± 125
h6	0 - 6	0 - 8	0 - 9	0 - 11	0 - 13	0 - 16

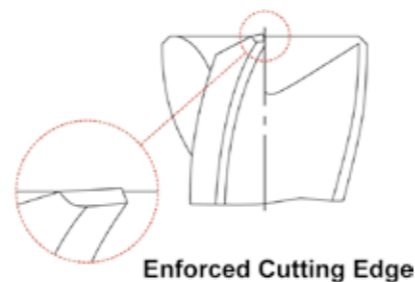

◎ : Excellent ○ : Good

ISO	P										M				K					
	Non-alloy steel					Low alloy steel					High alloyed steel, and tool steel		Stainless steel		Grey cast iron	Nodular cast iron	Malleable cast iron			
Material Description	1	2	3	4	5	6	7	8	9	10	11	12	13	14	15	16	17	18	19	20
VDI 3323	1	2	3	4	5	6	7	8	9	10	11	12	13	14	15	16	17	18	19	20
HRc	13	25	28	32	35	38	42	45	48	52	55	58	60	62	65	68	70	72	74	76
HB	125	190	250	270	300	350	400	450	500	550	600	650	700	750	800	850	900	950	1000	1050
Recommend	◎	◎	◎	◎	◎	◎	◎	◎	◎	◎	◎	◎	◎	◎	◎	◎	◎	◎	◎	◎



UNCOATED **E9A33** SERIES
X-COATING **GAA33** SERIES

HSS-PM, MULTI FLUTE SHORT LENGTH ROUGHING - COARSE

- HSS-PM, MULTI SCHNEIDEN KURZ SCHRUPFRÄSER - GROB
- FRAISES HSS-PM, MULTI-DENTS RAVAGEUSE - PAS GROSSIERS, SÉRIE COURTE
- MULTI TAGL., PER SGROS., SERIE CORTA, BOMBATO GROSSO - HSS PM

- ▶ Suitable for high-feed roughing milling.
- ▶ Designed to machine carbon steels, alloyed steels, stainless steels.
- ▶ YG-1's new developed TANK-POWER Coating suitable for high speed cutting.
- ▶ up to Ø20 : center cut, over Ø20 : non center cut
- ▶ Geeignet zum HSC - Schrupp - Fräsen.
- ▶ Geeignet zum Fräsen von Stahl, legiertem Stahl und rostfreier Stahl.
- ▶ Neuentwickelte Beschichtung für Hochgeschwindigkeitsfräsen.
- ▶ Bis D<=20mm : mit Zentrumschnitt, über D<=20mm : Ohne Zentrumschnitt.

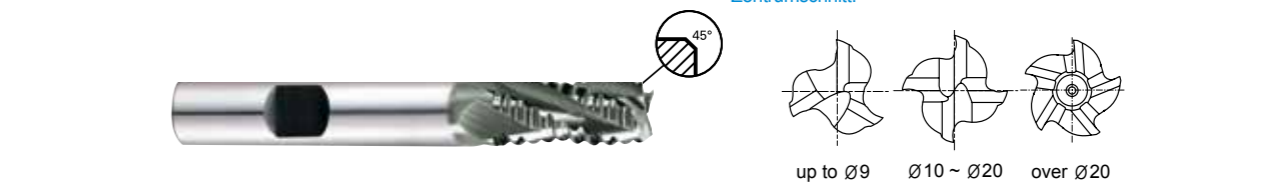

HSS PM, DIN 844, NR, 3-5, 30°, DIN 1835B, UNCOATED, X Coating, C x 45°, p.C632-633

Flat Shank	Page	Plain Shank	Page
END MILL HOLDER	D118-137	POWER MILLING CHUCK	D161-176
		ER COLLET CHUCK	D73-116
		SK SLIM CHUCK	D183-201

Unit : mm

EDP No.	Mill Diameter	Shank Diameter	Length of Cut	Overall Length	No. of Flute	Chamfer	
							UNCOATED
E9A33060	GAA33060	6.0	6	13	57	3	0.25
E9A33070	GAA33070	7.0	10	16	66	3	0.25
E9A33080	GAA33080	8.0	10	19	69	3	0.25
E9A33090	GAA33090	9.0	10	19	69	3	0.36
E9A33100	GAA33100	10.0	10	22	72	4	0.36
E9A33120	GAA33120	12.0	12	26	83	4	0.5
E9A33140	GAA33140	14.0	12	26	83	4	0.55
E9A33160	GAA33160	16.0	16	32	92	4	0.55
E9A33180	GAA33180	18.0	16	32	92	4	0.55
E9A33200	GAA33200	20.0	20	38	104	4	0.55
E9A33220	GAA33220	22.0	20	38	104	5	0.55
E9A33250	GAA33250	25.0	25	45	121	5	0.55

Tolerances according to DIN 7160 & 7161

	Tolerance range in μm					
	Nominal-Diameter in mm					
	from 1 to 3	over 3 to 6	over 6 to 10	over 10 to 18	over 18 to 30	over 30 to 50
js12	± 50	± 60	± 75	± 90	± 105	± 125
h6	0 - 6	0 - 8	0 - 9	0 - 11	0 - 13	0 - 16

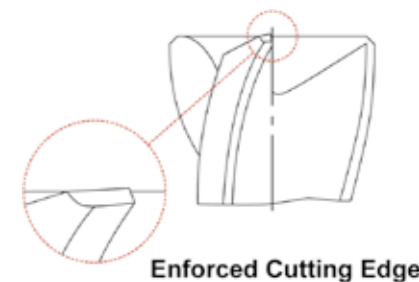

◎ : Excellent ○ : Good

ISO	P										M				K					
	Non-alloy steel					Low alloy steel					High alloyed steel, and tool steel		Stainless steel		Grey cast iron	Nodular cast iron	Malleable cast iron			
Material Description	1	2	3	4	5	6	7	8	9	10	11	12	13	14	15	16	17	18	19	20
VDI 3323	1	2	3	4	5	6	7	8	9	10	11	12	13	14	15	16	17	18	19	20
HRc	13	25	28	32	35	38	42	45	48	52	55	58	60	62	65	68	70	72	74	76
HB	125	190	250	270	300	350	400	450	500	550	600	650	700	750	800	850	900	950	1000	1050
Recommend	◎	◎	◎	◎	◎	◎	◎	◎	◎	◎	◎	◎	◎	◎	◎	◎	◎	◎	◎	◎



UNCOATED **E9A34** SERIES
X-COATING **GAA34** SERIES

HSS-PM, MULTI FLUTE LONG LENGTH ROUGHING - COARSE

- HSS-PM, MULTI SCHNEIDEN LANG SCHRUPFRÄSER - GROB
- FRAISES HSS-PM, MULTI-DENTS RAVAGEUSE - PAS GROSSIERS, SÉRIE LONGUE
- MULTI TAGL., PER SGROSSATURA, SERIE LUNGA, BOMBATO GROSSO - HSS PM

- Suitable for high-feed roughing milling.
- Designed to machine carbon steels, alloyed steels, stainless steels.
- YG-1's new developed TANK-POWER Coating suitable for high speed cutting.
- up to $\varnothing 20$: center cut, over $\varnothing 20$: non center cut

- Geeignet zum HSC - Schrupp - Fräsen.
- Geeignet zum Fräsen von Stahl, legiertem Stahl und rostfreier Stahl.
- Neuentwickelte Beschichtung für Hochgeschwindigkeitsfräsen.
- Bis $D \leq 20\text{mm}$: mit Zentrumschnitt, über $D > 20\text{mm}$: Ohne Zentrumschnitt.

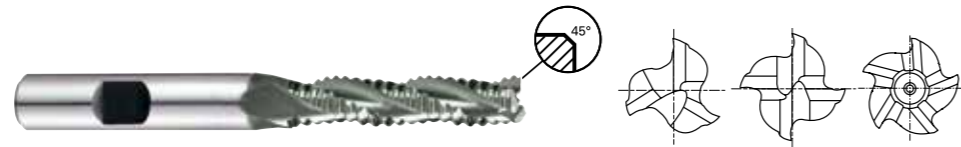

HSS PM, DIN 844, NR, 3-5, 30°, DIN 1835B, UNCOATED, X Coating, p.C632-633

Recommended ToolHolder	Flat Shank	Page	Plain Shank	Page
⊗	END MILL HOLDER	D118 - 137	POWER MILLING CHUCK	D161 - 176
⊙	-	-	ER COLLET CHUCK	D73 - 116
⊙	-	-	SK SLIM CHUCK	D183 - 201

Unit : mm

EDP No.	Mill Diameter	Shank Diameter	Length of Cut	Overall Length	No. of Flute	Chamfer
E9A34060	6.0	6	24	68	3	0.25
E9A34070	7.0	10	30	80	3	0.25
E9A34080	8.0	10	38	88	3	0.25
E9A34090	9.0	10	38	88	3	0.36
E9A34100	10.0	10	45	95	4	0.36
E9A34120	12.0	12	53	110	4	0.5
E9A34140	14.0	12	53	110	4	0.55
E9A34160	16.0	16	63	123	4	0.55
E9A34180	18.0	16	63	123	4	0.55
E9A34200	20.0	20	75	141	4	0.55
E9A34220	22.0	20	75	141	5	0.55
E9A34250	25.0	25	90	166	5	0.55

Tolerances according to DIN 7160 & 7161

	Tolerance range in μm					
	Nominal-Diameter in mm					
	from 1 to 3	over 3 to 6	over 6 to 10	over 10 to 18	over 18 to 30	over 30 to 50
js12	± 50	± 60	± 75	± 90	± 105	± 125
h6	0 -6	0 -8	0 -9	0 -11	0 -13	0 -16

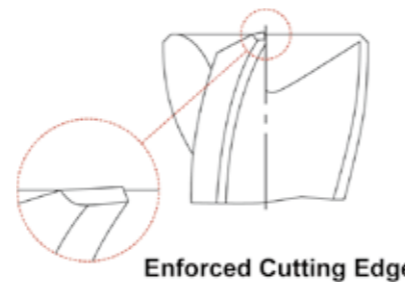

Enforced Cutting Edge

⊗ : Excellent ○ : Good

ISO	P										M				K					
	Non-alloy steel					Low alloy steel					High alloyed steel, and tool steel		Stainless steel		Grey cast iron	Nodular cast iron		Malleable cast iron		
Material Description	1	2	3	4	5	6	7	8	9	10	11	12	13	14	15	16	17	18	19	20
VDI 3323	1	2	3	4	5	6	7	8	9	10	11	12	13	14	15	16	17	18	19	20
HRc	13	25	28	32	38	40	42	45	48	50	52	55	58	60	62	65	68	70	72	75
HB	125	190	250	270	300	180	275	300	350	200	325	200	240	180	180	260	160	250	130	230
Recommend	⊗	⊗	⊗	⊗	⊗	⊗	⊗	⊗	⊗	⊗	⊗	⊗	⊗	⊗	⊗	⊗	⊗	⊗	⊗	⊗



UNCOATED **E9E43** SERIES
X-COATING **GAE43** SERIES

HSS-PM, 4&5 FLUTE ROUGHING WITH NECK - COARSE

- HSS-PM, 4&5 SCHNEIDEN SCHRUPFRÄSER mit ABGESETZTEM SCHAFTTETL - GROB
- FRAISES HSS-PM, 4&5-DENTS RAVAGEUSE AVEC DÉGAGEMENT - PAS GROSSIERS
- 4&5 TAGL., PER SGROSSATURA, SCARICATA - HSS PM

- High chip removal and minimizing breakages of cutting edges.
- Design to machine carbon steels, alloyed steels, stainless steels.
- YG-1's new developed TANK-POWER Coating suitable for high speed cutting.

- Schnelle Spanabfuhr und Minimierung von Schneidkantenausbrüchen
- Geeignet zum Fräsen von Stahl, legiertem Stahl und rostfreier Stahl.
- Neuentwickelte Beschichtung für Hochgeschwindigkeitsfräsen.

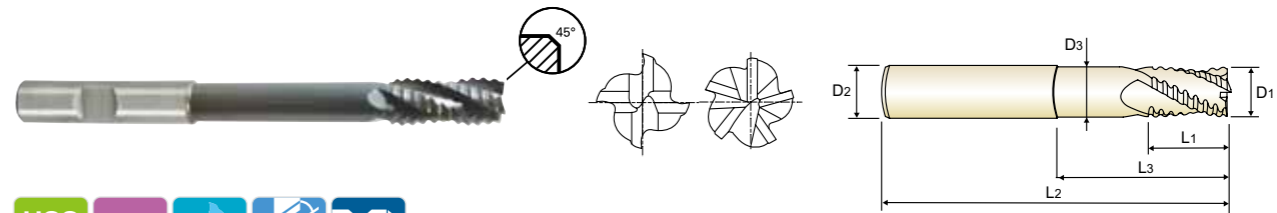

HSS PM, NR, 4&5, 30°, DIN 1835B, UNCOATED, X Coating, p.C636-637

Recommended ToolHolder	Flat Shank	Page	Plain Shank	Page
⊗	END MILL HOLDER	D118 - 137	POWER MILLING CHUCK	D161 - 176
⊙	-	-	ER COLLET CHUCK	D73 - 116
⊙	-	-	SK SLIM CHUCK	D183 - 201

Unit : mm

EDP No.	Mill Diameter	Shank Diameter	Length of Cut	Length Below Shank	Overall Length	Neck Diameter	No. of Flute	Chamfer
E9E43100	10.0	10	22	69	110	8.5	4	0.34
E9E43120	12.0	12	26	78	125	10.5	4	0.50
E9E43160	16.0	16	32	87	138	14	4	0.55
E9E43200	20.0	20	38	108	160	18	5	0.55
E9E43250	25.0	25	45	155	216	23	5	0.55

Tolerances according to DIN 7160 & 7161

	Tolerance range in μm					
	Nominal-Diameter in mm					
	from 1 to 3	over 3 to 6	over 6 to 10	over 10 to 18	over 18 to 30	over 30 to 50
js12	± 50	± 60	± 75	± 90	± 105	± 125
h6	0 -6	0 -8	0 -9	0 -11	0 -13	0 -16

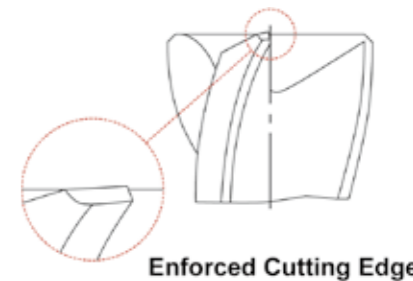

Enforced Cutting Edge

⊗ : Excellent ○ : Good

ISO	P										M				K					
	Non-alloy steel					Low alloy steel					High alloyed steel, and tool steel		Stainless steel		Grey cast iron	Nodular cast iron		Malleable cast iron		
Material Description	1	2	3	4	5	6	7	8	9	10	11	12	13	14	15	16	17	18	19	20
VDI 3323	1	2	3	4	5	6	7	8	9	10	11	12	13	14	15	16	17	18	19	20
HRc	13	25	28	32	38	40	42	45	48	50	52	55	58	60	62	65	68	70	72	75
HB	125	190	250	270	300	180	275	300	350	200	325	200	240	180	180	260	160	250	130	230
Recommend	⊗	⊗	⊗	⊗	⊗	⊗	⊗	⊗	⊗	⊗	⊗	⊗	⊗	⊗	⊗	⊗	⊗	⊗	⊗	⊗

GA940 , GAA32 SERIES 2 FLUTE BALL NOSE

Vc = m/min.
fz = mm/tooth
RPM = rev./min.
FEED = mm/min.

E9940 , E9A32 SERIES 2 FLUTE BALL NOSE

Vc = m/min.
fz = mm/tooth
RPM = rev./min.
FEED = mm/min.

ISO	VDI 3323	Material Description	Ae	Ap	Parameter	Diameter (Ø)										
						3.0	4.0	6.0	8.0	10.0	12.0	16.0	20.0	25.0		
P	1	Non-alloy steel	0.5D	0.2D	Vc	70	75	85	85	85	85	85	85	85	85	75
					fz	0.023	0.036	0.055	0.079	0.109	0.115	0.141	0.156	0.163		
					RPM	7427	5968	4509	3382	2706	2255	1691	1353	955		
	FEED		342	430	496	534	590	519	477	422	311					
	2		Vc	55	60	65	65	65	70	65	65	60				
			fz	0.02	0.031	0.046	0.067	0.095	0.097	0.123	0.14	0.142				
			RPM	5836	4775	3448	2586	2069	1857	1293	1035	764				
	FEED		233	296	317	347	393	360	318	290	217					
	3-4		Vc	35	40	45	45	45	45	45	45	35				
			fz	0.016	0.027	0.039	0.056	0.082	0.083	0.101	0.11	0.122				
			RPM	3714	3183	2387	1790	1432	1194	895	716	446				
FEED	119	172	186	201	235	198	181	158	109							
5	Vc	20	20	25	20	20	20	20	25	20						
	fz	0.014	0.023	0.035	0.048	0.075	0.073	0.091	0.097	0.104						
	RPM	2122	1592	1326	796	637	531	398	398	255						
FEED	59	73	93	76	95	77	72	77	53							
6	Vc	55	60	65	65	65	70	65	65	60						
	fz	0.02	0.031	0.046	0.067	0.095	0.097	0.123	0.14	0.142						
	RPM	5836	4775	3448	2586	2069	1857	1293	1035	764						
FEED	233	296	317	347	393	360	318	290	217							
7	Vc	35	40	45	45	45	45	45	45	35						
	fz	0.016	0.027	0.039	0.056	0.082	0.083	0.101	0.11	0.122						
	RPM	3714	3183	2387	1790	1432	1194	895	716	446						
FEED	119	172	186	201	235	198	181	158	109							
8-9	Vc	20	20	25	20	20	20	20	25	20						
	fz	0.014	0.023	0.035	0.048	0.075	0.073	0.091	0.097	0.104						
	RPM	2122	1592	1326	796	637	531	398	398	255						
FEED	59	73	93	76	95	77	72	77	53							
10	Vc	55	60	65	65	65	70	65	65	60						
	fz	0.02	0.031	0.046	0.067	0.095	0.097	0.123	0.14	0.142						
	RPM	5836	4775	3448	2586	2069	1857	1293	1035	764						
FEED	233	296	317	347	393	360	318	290	217							
11.1	Vc	20	20	25	20	20	20	20	25	20						
	fz	0.014	0.023	0.035	0.048	0.075	0.073	0.091	0.097	0.104						
	RPM	2122	1592	1326	796	637	531	398	398	255						
FEED	59	73	93	76	95	77	72	77	53							
M 14.1	Vc	20	20	25	25	25	25	25	25	20						
	fz	0.014	0.023	0.036	0.048	0.073	0.074	0.092	0.1	0.1						
	RPM	2122	1592	1326	995	796	663	497	398	255						
FEED	59	73	95	95	116	98	92	80	51							
K 15-20	Vc	55	60	65	65	65	70	65	65	60						
	fz	0.02	0.031	0.046	0.067	0.095	0.097	0.123	0.14	0.142						
	RPM	5836	4775	3448	2586	2069	1857	1293	1035	764						
FEED	233	296	317	347	393	360	318	290	217							

ISO	VDI 3323	Material Description	Ae	Ap	Parameter	Diameter (Ø)									
						3.0	4.0	6.0	8.0	10.0	12.0	16.0	20.0	25.0	
P	1	Non-alloy steel	0.5D	0.2D	Vc	45	50	55	60	55	55	55	60	50	
					fz	0.021	0.033	0.05	0.072	0.103	0.11	0.136	0.14	0.148	
					RPM	4775	3979	2918	2387	1751	1459	1094	955	637	
	FEED		201	263	292	344	361	321	298	267	188				
	2		Vc	35	40	45	45	45	45	45	45	40			
			fz	0.018	0.029	0.043	0.061	0.089	0.092	0.111	0.12	0.13			
			RPM	3714	3183	2387	1790	1432	1194	895	716	509			
	FEED		134	185	205	218	255	220	199	172	132				
	3-4		Vc	25	25	30	30	30	30	30	30	25			
			fz	0.015	0.024	0.034	0.052	0.07	0.076	0.092	0.099	0.103			
			RPM	2653	1989	1592	1194	955	796	597	477	318			
FEED	80	95	108	124	134	121	110	95	66						
5	Vc	10	15	15	15	15	15	15	15	15					
	fz	0.013	0.023	0.034	0.046	0.068	0.069	0.083	0.094	0.086					
	RPM	1061	1194	796	597	477	398	298	239	191					
FEED	28	55	54	55	65	55	50	45	33						
6	Vc	35	40	45	45	45	45	45	45	40					
	fz	0.018	0.029	0.043	0.061	0.089	0.092	0.111	0.12	0.13					
	RPM	3714	3183	2387	1790	1432	1194	895	716	509					
FEED	134	185	205	218	255	220	199	172	132						
7	Vc	25	25	30	30	30	30	30	30	25					
	fz	0.015	0.024	0.034	0.052	0.07	0.076	0.092	0.099	0.103					
	RPM	2653	1989	1592	1194	955	796	597	477	318					
FEED	80	95	108	124	134	121	110	95	66						
8-9	Vc	10	15	15	15	15	15	15	15	15					
	fz	0.013	0.023	0.034	0.046	0.068	0.069	0.083	0.094	0.086					
	RPM	1061	1194	796	597	477	398	298	239	191					
FEED	28	55	54	55	65	55	50	45	33						
10	Vc	35	40	45	45	45	45	45	45	40					
	fz	0.018	0.029	0.043	0.061	0.089	0.092	0.111	0.12	0.13					
	RPM	3714	3183	2387	1790	1432	1194	895	716	509					
FEED	134	185	205	218	255	220	199	172	132						
11.1	Vc	10	15	15	15	15	15	15	15	15					
	fz	0.013	0.023	0.034	0.046	0.068	0.069	0.083	0.094	0.086					
	RPM	1061	1194	796	597	477	398	298	239	191					
FEED	28	55	54	55	65	55	50	45	33						
M 14.1	Vc	15	15	15	15	15	15	15	15	15					
	fz	0.014	0.025	0.036	0.049	0.075	0.074	0.091	0.104	0.09					
	RPM	1592	1194	796	597	477	398	298	239	191					
FEED	45	60	57	58	72	59	54	50	34						
K 15-20	Vc	35	40	45	45	45	45	45	45	40					
	fz	0.018	0.029	0.043	0.061	0.089	0.092	0.111	0.12	0.13					
	RPM	3714	3183	2387	1790	1432	1194	895	716	509					
FEED	134	185	205	218	255	220	199	172	132						

※ The FEED, in long & extra long types, should be reduced by around 50%

※ The FEED, in long & extra long types, should be reduced by around 50%

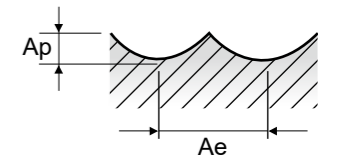
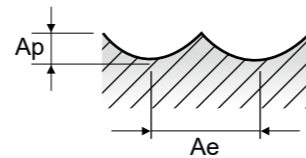

GA936, GAA29 SERIES 2 FLUTE - SLOTTING

Vc = m/min. fz = mm/tooth RPM = rev./min. FEED = mm/min.

Table with columns for ISO, VDI 3323, Material Description, Ae, Ap, Parameter, and Diameter (Ø) from 2.0 to 25.0. Rows include Non-alloy steel, Low alloy steel, High alloyed steel, and tool steel.

※ The FEED, in long & extra long types, should be reduced by around 50%

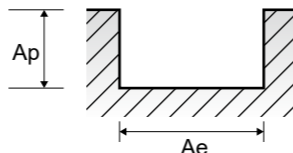

E9936, E9A29 SERIES 2 FLUTE - SLOTTING

Vc = m/min. fz = mm/tooth RPM = rev./min. FEED = mm/min.

Table with columns for ISO, VDI 3323, Material Description, Ae, Ap, Parameter, and Diameter (Ø) from 2.0 to 25.0. Rows include Non-alloy steel, Low alloy steel, High alloyed steel, and tool steel.

※ The FEED, in long & extra long types, should be reduced by around 50%

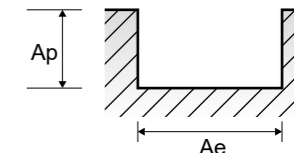

GA942 , GAA30 SERIES 3 FLUTE - **SLOTING**

Vc = m/min.
fz = mm/tooth
RPM = rev./min.
FEED = mm/min.

ISO	VDI 3323	Material Description	Ae	Ap	Parameter	Diameter (Ø)														
						2.0	3.0	4.0	5.0	6.0	8.0	10.0	12.0	14.0	16.0	18.0	20.0	22.0	25.0	
P	1	Non-alloy steel	1.0D	0.5D	Vc	40	45	55	60	65	65	65	70	70	70	65	60	60	60	
					fz	0.004	0.007	0.011	0.014	0.023	0.031	0.033	0.051	0.052	0.059	0.07	0.081	0.091	0.107	
					RPM	6366	4775	4377	3820	3448	2586	2069	1857	1592	1393	1149	955	868	764	
					FEED	76	100	144	160	238	241	205	284	248	246	241	232	237	245	
	2		Vc	35	35	45	50	55	55	55	55	60	60	50	50	50	50			
			fz	0.003	0.007	0.011	0.014	0.023	0.032	0.039	0.053	0.054	0.061	0.071	0.08	0.089	0.111			
			RPM	5570	3714	3581	3183	2918	2188	1751	1459	1364	1194	884	796	723	637			
			FEED	50	78	118	134	201	210	205	232	221	218	188	191	193	212			
	3-4		Vc	30	30	40	40	45	45	45	45	45	45	45	45	40	40			
			fz	0.003	0.005	0.009	0.012	0.02	0.028	0.038	0.047	0.053	0.056	0.063	0.067	0.083	0.109			
			RPM	4775	3183	3183	2546	2387	1790	1432	1194	1023	895	796	716	579	509			
FEED		43	48	86	92	143	150	163	168	163	150	150	144	144	167					
5	Vc	20	20	25	25	25	30	30	30	30	30	30	30	30	30					
	fz	0.004	0.007	0.009	0.012	0.021	0.03	0.043	0.052	0.056	0.061	0.063	0.07	0.079	0.094					
	RPM	3183	2122	1989	1592	1326	1194	955	796	682	597	531	477	434	382					
	FEED	38	45	54	57	84	107	123	124	115	109	100	100	103	108					
6	Vc	35	35	45	50	55	55	55	55	60	60	50	50	50	50					
	fz	0.003	0.007	0.011	0.014	0.023	0.032	0.039	0.053	0.054	0.061	0.071	0.08	0.089	0.111					
	RPM	5570	3714	3581	3183	2918	2188	1751	1459	1364	1194	884	796	723	637					
	FEED	50	78	118	134	201	210	205	232	221	218	188	191	193	212					
7	Vc	30	30	40	40	45	45	45	45	45	45	45	40	40						
	fz	0.003	0.005	0.009	0.012	0.02	0.028	0.038	0.047	0.053	0.056	0.063	0.067	0.083	0.109					
	RPM	4775	3183	3183	2546	2387	1790	1432	1194	1023	895	796	716	579	509					
	FEED	43	48	86	92	143	150	163	168	163	150	150	144	144	167					
8	Vc	20	20	25	25	25	30	30	30	30	30	30	30	30	30					
	fz	0.004	0.007	0.009	0.012	0.021	0.03	0.043	0.052	0.056	0.061	0.063	0.07	0.079	0.094					
	RPM	3183	2122	1989	1592	1326	1194	955	796	682	597	531	477	434	382					
	FEED	38	45	54	57	84	107	123	124	115	109	100	100	103	108					
9	Vc	10	15	20	20	20	20	20	20	20	25	25	20	20						
	fz	0.005	0.008	0.012	0.014	0.023	0.032	0.045	0.053	0.057	0.064	0.067	0.074	0.09	0.113					
	RPM	1592	1592	1592	1273	1061	796	637	531	455	398	442	398	289	255					
	FEED	24	38	57	53	73	76	86	84	78	76	89	88	78	86					
10	Vc	35	35	45	50	55	55	55	55	60	60	50	50	50	50					
	fz	0.003	0.007	0.011	0.014	0.023	0.032	0.039	0.053	0.054	0.061	0.071	0.08	0.089	0.111					
	RPM	5570	3714	3581	3183	2918	2188	1751	1459	1364	1194	884	796	723	637					
	FEED	50	78	118	134	201	210	205	232	221	218	188	191	193	212					
11.1	Vc	20	20	25	25	25	30	30	30	30	30	30	30	30	30					
	fz	0.004	0.007	0.009	0.012	0.021	0.03	0.043	0.052	0.056	0.061	0.063	0.07	0.079	0.094					
	RPM	3183	2122	1989	1592	1326	1194	955	796	682	597	531	477	434	382					
	FEED	38	45	54	57	84	107	123	124	115	109	100	100	103	108					
K 15-20	Grey cast iron Nodular cast iron Malleable cast iron	1.0D	0.5D	Vc	35	35	45	50	55	55	55	60	60	50	50	50				
				fz	0.003	0.007	0.011	0.014	0.023	0.032	0.039	0.053	0.054	0.061	0.071	0.08	0.089	0.111		
				RPM	5570	3714	3581	3183	2918	2188	1751	1459	1364	1194	884	796	723	637		
				FEED	50	78	118	134	201	210	205	232	221	218	188	191	193	212		

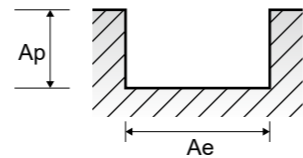

GA942 , GAA30 SERIES 3 FLUTE - **SIDE CUTTING**

Vc = m/min.
fz = mm/tooth
RPM = rev./min.
FEED = mm/min.

ISO	VDI 3323	Material Description	Ae	Ap	Parameter	Diameter (Ø)														
						2.0	3.0	4.0	5.0	6.0	8.0	10.0	12.0	14.0	16.0	18.0	20.0	22.0	25.0	
P	1	Non-alloy steel	0.1D	1.5D	Vc	50	55	65	75	80	80	80	80	80	80	80	80	80		
					fz	0.004	0.008	0.012	0.015	0.024	0.034	0.047	0.056	0.065	0.069	0.077	0.08	0.09	0.11	
					RPM	7958	5836	5173	4775	4244	3183	2546	2122	1819	1592	1326	1273	1157	1019	
					FEED	95	140	186	215	306	325	359	357	355	329	306	306	313	336	
					Vc	45	45	55	65	70	65	65	70	65	65	65	65	65	65	
	2		fz	0.004	0.008	0.012	0.015	0.023	0.035	0.046	0.056	0.063	0.071	0.077	0.081	0.093	0.109			
			RPM	7162	4775	4377	4138	3714	2586	2069	1857	1478	1293	1149	1035	940	828			
			FEED	86	115	158	186	256	272	286	312	279	275	266	251	262	271			
			Vc	35	35	45	45	50	50	55	50	50	50	50	50	50	50			
			fz	0.004	0.007	0.01	0.014	0.024	0.033	0.044	0.055	0.061	0.067	0.073	0.081	0.088	0.111			
	3-4		RPM	5570	3714	3581	2865	2653	1989	1592	1459	1137	995	884	796	723	637			
FEED		67	78	107	120	191	197	210	241	208	200	194	193	191	212					
Vc		25	25	30	30	35	35	30	35	35	35	35	35	35	35					
fz		0.004	0.008	0.011	0.014	0.023	0.036	0.05	0.056	0.06	0.071	0.075	0.08	0.092	0.107					
RPM		3979	2653	2387	1910	1857	1393	955	928	796	696	619	557	434	446					
5	FEED	48	64	79	80	128	150	143	156	143	148	139	134	120	143					
	Vc	45	45	55	65	70	65	65	70	65	65	65	65	65	65					
	fz	0.004	0.008	0.012	0.015	0.023	0.035	0.046	0.056	0.063	0.071	0.077	0.081	0.093	0.109					
	RPM	7162	4775	4377	4138	3714	2586	2069	1857	1478	1293	1149	1035	940	828					
	FEED	86	115	158	186	256	272	286	312	279	275	266	251	262	271					
6	Vc	35	35	45	45	50	50	55	50	50	50	50	50	50	50					
	fz	0.004	0.007	0.01	0.014	0.024	0.033	0.044	0.055	0.061	0.067	0.073	0.081	0.088	0.111					
	RPM	5570	3714	3581	2865	2653	1989	1592	1459	1137	995	884	796	723	637					
	FEED	67	78	107	120	191	197	210	241	208	200	194	193	191	212					
	Vc	25	25	30	30	35	35	30	35	35	35	35	35	35	35					
7	fz	0.004	0.008	0.011	0.014	0.023	0.036	0.05	0.056	0.06	0.071	0.075	0.08	0.092	0.107					
	RPM	3979	2653	2387	1910	1857	1393	955	928	796	696	619	557	434	446					
	FEED	48	64	79	80	128	150	143	156	143	148	139	134	120	143					
	Vc	15	20	25	25	30	30	30	30	30	30	30	30	30	30					
	fz	0.006	0.01	0.013	0.015	0.022	0.035	0.047	0.056	0.063	0.07	0.073	0.083	0.092	0.111					
8	RPM	2387	2122	1989	1592	1592	1194	955	796	682	597	531	477	434	382					
	FEED	43	64	78	72	105	125	135	134	129	125	116	119	120	127					
	Vc	45	45	55	65	70	65	65	70	65	65	65	65	65	65					
	fz	0.004	0.008	0.012	0.015	0.023	0.035	0.046	0.056	0.063	0.071	0.077	0.081	0.093	0.109					
	RPM	7162	4775	4377	4138	3714	2586	2069	1857	1478	1293	1149	1035	940	828					
9	FEED	86	115	158	186	256	272	286	312	279	275	266	251	262	271					
	Vc	25	25	30	30	35	35	30	35	35	35	35	35	35	35					
	fz	0.004	0.008	0.011	0.014	0.023	0.036	0.05	0.056	0.06	0.071	0.075</								

E9942 , E9A30 SERIES 3 FLUTE - SLOTTING

Vc = m/min.
fz = mm/tooth
RPM = rev./min.
FEED = mm/min.

Table with columns: ISO, VDI 3323, Material Description, Ae, Ap, Parameter, Diameter (Ø) (2.0 to 25.0), Vc, fz, RPM, FEED. Rows include Non-alloy steel, Low alloy steel, High alloyed steel, and tool steel.

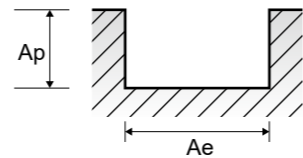

E9942 , E9A30 SERIES 3 FLUTE - SIDE CUTTING

Vc = m/min.
fz = mm/tooth
RPM = rev./min.
FEED = mm/min.

Table with columns: ISO, VDI 3323, Material Description, Ae, Ap, Parameter, Diameter (Ø) (2.0 to 25.0), Vc, fz, RPM, FEED. Rows include Non-alloy steel, Low alloy steel, High alloyed steel, and tool steel.

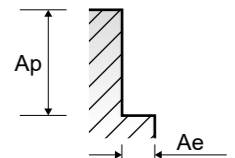

GA938, GAA31 SERIES 4 FLUTE - SIDE CUTTING

Vc = m/min. fz = mm/tooth RPM = rev./min. FEED = mm/min.

E9938, E9A31 SERIES 4 FLUTE - SIDE CUTTING

Vc = m/min. fz = mm/tooth RPM = rev./min. FEED = mm/min.

Table with columns: ISO, VDI 3323, Material Description, Ae, Ap, Parameter, Diameter (Ø) [2.0, 3.0, 4.0, 5.0, 6.0, 8.0, 10.0, 12.0, 14.0, 16.0, 18.0, 20.0, 22.0, 25.0]. Rows include Non-alloy steel, Low alloy steel, High alloyed steel, and tool steel.

Table with columns: ISO, VDI 3323, Material Description, Ae, Ap, Parameter, Diameter (Ø) [2.0, 3.0, 4.0, 5.0, 6.0, 8.0, 10.0, 12.0, 14.0, 16.0, 18.0, 20.0, 22.0, 25.0]. Rows include Non-alloy steel, Low alloy steel, High alloyed steel, and tool steel.

※ The FEED, in long & extra long types, should be reduced by around 50%

※ The FEED, in long & extra long types, should be reduced by around 50%

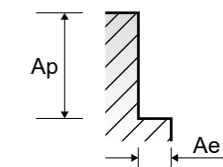
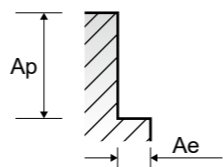

GA941, GAA35, GAA33, GAA34 SERIES MULTI FLUTE ROUGHING - SIDE CUTTING

Vc = m/min.
fz = mm/tooth
RPM = rev./min.
FEED = mm/min.

ISO	VDI 3323	Material Description	Ae	Ap	Parameter	Diameter (Ø)											
						6.0	8.0	10.0	12.0	22.0	25.0	18.0	20.0	22.0	25.0		
P	1	Non-alloy steel	0.5D	1.5D	Vc	55	60	60	60	60	60	60	60	60	60	60	60
					fz	0.027	0.04	0.055	0.065	0.074	0.086	0.099	0.111	0.096	0.105		
					RPM	2918	2387	1910	1592	1364	1194	1061	955	868	764		
	2		Vc	40	50	45	45	45	50	50	50	45	45				
			fz	0.022	0.04	0.053	0.069	0.079	0.087	0.093	0.109	0.102	0.105				
			RPM	2122	1989	1432	1194	1023	995	884	796	651	573				
	3-4		Vc	30	35	35	35	35	35	35	30	35					
			fz	0.024	0.038	0.046	0.064	0.076	0.087	0.094	0.108	0.098	0.105				
			RPM	1592	1393	1114	928	796	696	619	557	434	446				
	5		Vc	25	25	30	30	30	30	30	30	30					
			fz	0.027	0.04	0.045	0.061	0.071	0.082	0.092	0.102	0.09	0.1				
RPM		1326	995	955	796	682	597	531	477	434	382						
6	Vc	40	50	45	45	45	50	50	45	45							
	fz	0.027	0.04	0.053	0.069	0.079	0.087	0.093	0.109	0.102	0.105						
	RPM	2122	1989	1432	1194	1023	995	884	796	651	573						
7	Vc	30	35	35	35	35	35	35	30	35							
	fz	0.024	0.038	0.046	0.064	0.076	0.087	0.094	0.108	0.098	0.105						
	RPM	1592	1393	1114	928	796	696	619	557	434	446						
8-9	Vc	25	25	30	30	30	30	30	30	30							
	fz	0.027	0.04	0.045	0.061	0.071	0.082	0.092	0.102	0.09	0.1						
	RPM	1326	995	955	796	682	597	531	477	434	382						
10	Vc	40	50	45	45	45	50	50	45	45							
	fz	0.027	0.04	0.053	0.069	0.079	0.087	0.093	0.109	0.102	0.105						
	RPM	2122	1989	1432	1194	1023	995	884	796	651	573						
11.1	Vc	25	25	30	30	30	30	30	30	30							
	fz	0.027	0.04	0.045	0.061	0.071	0.082	0.092	0.102	0.09	0.1						
	RPM	1326	995	955	796	682	597	531	477	434	382						
M	14.1	Stainless steel	0.5D	1.5D	Vc	25	30	30	30	30	30	30	30	30			
					fz	0.025	0.039	0.045	0.064	0.074	0.085	0.093	0.107	0.095	0.103		
					RPM	1326	1194	955	796	682	597	531	477	434	382		
K	15-20	Grey cast iron Nodular cast iron Malleable cast iron	0.5D	1.5D	Vc	40	50	45	45	45	50	50	45	45			
					fz	0.027	0.04	0.053	0.069	0.079	0.087	0.093	0.109	0.102	0.105		
					RPM	2122	1989	1432	1194	1023	995	884	796	651	573		

※ The FEED, in long & extra long types, should be reduced by around 50%

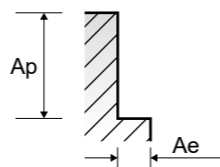

E9941, E9A35, E9A33, E9A34 SERIES MULTI FLUTE ROUGHING - SIDE CUTTING

Vc = m/min.
fz = mm/tooth
RPM = rev./min.
FEED = mm/min.

ISO	VDI 3323	Material Description	Ae	Ap	Parameter	Diameter (Ø)									
						6.0	8.0	10.0	12.0	22.0	25.0	18.0	20.0	22.0	25.0
P	1	Non-alloy steel	0.5D	1.5D	Vc	35	40	40	40	40	40	40	40	40	40
					fz	0.018	0.028	0.05	0.059	0.056	0.063	0.061	0.067	0.072	0.08
					RPM	1857	1592	1273	1061	909	796	707	637	579	509
	2		Vc	30	35	30	30	30	35	30	30	30			
			fz	0.018	0.027	0.049	0.063	0.058	0.064	0.056	0.067	0.078	0.081		
			RPM	1592	1393	955	796	682	597	619	477	434	382		
	3-4		Vc	20	25	20	25	20	25	25	20	20			
			fz	0.017	0.028	0.044	0.058	0.055	0.062	0.057	0.065	0.073	0.08		
			RPM	1061	995	637	663	455	497	442	398	289	255		
	5		Vc	15	20	20	20	20	20	20	20	20			
			fz	0.018	0.027	0.042	0.055	0.051	0.059	0.056	0.061	0.068	0.076		
RPM		796	796	637	531	455	398	354	318	289	255				
6	Vc	30	35	30	30	30	35	30	30	30					
	fz	0.018	0.027	0.049	0.063	0.058	0.064	0.056	0.067	0.078	0.081				
	RPM	1592	1393	955	796	682	597	619	477	434	382				
7	Vc	20	25	20	25	20	25	25	20	20					
	fz	0.017	0.028	0.044	0.058	0.055	0.062	0.057	0.065	0.073	0.08				
	RPM	1061	995	637	663	455	497	442	398	289	255				
8-9	Vc	15	20	20	20	20	20	20	20	20					
	fz	0.018	0.027	0.042	0.055	0.051	0.059	0.056	0.061	0.068	0.076				
	RPM	796	796	637	531	455	398	354	318	289	255				
10	Vc	30	35	30	30	30	35	30	30	30					
	fz	0.018	0.027	0.049	0.063	0.058	0.064	0.056	0.067	0.078	0.081				
	RPM	1592	1393	955	796	682	597	619	477	434	382				
11.1	Vc	15	20	20	20	20	20	20	20	20					
	fz	0.018	0.027	0.042	0.055	0.051	0.059	0.056	0.061	0.068	0.076				
	RPM	796	796	637	531	455	398	354	318	289	255				
M	14.1	Stainless steel	0.5D	1.5D	Vc	20	20	20	20	20	20	20	20	20	
					fz	0.02	0.03	0.045	0.065	0.06	0.069	0.064	0.073	0.081	0.086
					RPM	1061	796	637	531	455	398	354	318	289	255
K	15-20	Grey cast iron Nodular cast iron Malleable cast iron	0.5D	1.5D	Vc	30	35	30	30	30	30	35	30	30	
					fz	0.018	0.027	0.049	0.063	0.058	0.064	0.056	0.067	0.078	0.081
					RPM	1592	1393	955	796	682	597	619	477	434	382

※ The FEED, in long & extra long types, should be reduced by around 50%

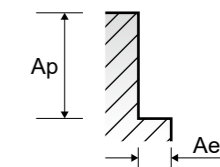

GAA26 SERIES MULTI FLUTE ROUGHING - SIDE CUTTING

Vc = m/min.
fz = mm/tooth
RPM = rev./min.
FEED = mm/min.

ISO	VDI 3323	Material Description	Ae	Ap	Parameter	Diameter (Ø)											
						6.0	8.0	10.0	12.0	14.0	16.0	18.0	20.0	22.0	25.0		
P	1	Non-alloy steel	0.5D	1.5D	Vc	55	60	60	60	60	60	60	60	60	60	60	60
					fz	0.021	0.03	0.055	0.065	0.059	0.069	0.066	0.074	0.08	0.088		
					RPM	2918	2387	1910	1592	1364	1194	1061	955	868	764		
	FEED		245	286	420	414	402	412	420	424	417	403					
	2		Vc	40	50	45	45	45	50	50	50	45	45				
			fz	0.02	0.03	0.053	0.069	0.063	0.069	0.062	0.072	0.085	0.088				
			RPM	2122	1989	1432	1194	1023	995	884	796	651	573				
	FEED		170	239	304	329	322	343	329	344	332	303					
	3-4		Vc	30	35	35	35	35	35	35	35	30	35				
			fz	0.018	0.029	0.046	0.064	0.061	0.07	0.063	0.072	0.082	0.087				
			RPM	1592	1393	1114	928	796	696	619	557	434	446				
FEED	115	162	205	238	243	244	234	241	214	233							
5	Vc	25	25	30	30	30	30	30	30	30	30						
	fz	0.02	0.03	0.045	0.061	0.057	0.065	0.061	0.068	0.075	0.083						
	RPM	1326	995	955	796	682	597	531	477	434	382						
FEED	106	119	172	194	194	194	194	195	195	190							
6	Vc	40	50	45	45	50	50	50	45	45							
	fz	0.02	0.03	0.053	0.069	0.063	0.069	0.062	0.072	0.085	0.088						
	RPM	2122	1989	1432	1194	1023	995	884	796	651	573						
FEED	170	239	304	329	322	343	329	344	332	303							
7	Vc	30	35	35	35	35	35	35	30	35							
	fz	0.018	0.029	0.046	0.064	0.061	0.07	0.063	0.072	0.082	0.087						
	RPM	1592	1393	1114	928	796	696	619	557	434	446						
FEED	115	162	205	238	243	244	234	241	214	233							
8-9	Vc	25	25	30	30	30	30	30	30	30	30						
	fz	0.02	0.03	0.045	0.061	0.057	0.065	0.061	0.068	0.075	0.083						
	RPM	1326	995	955	796	682	597	531	477	434	382						
FEED	106	119	172	194	194	194	195	195	190								
10	Vc	40	50	45	45	50	50	50	45	45							
	fz	0.02	0.03	0.053	0.069	0.063	0.069	0.062	0.072	0.085	0.088						
	RPM	2122	1989	1432	1194	1023	995	884	796	651	573						
FEED	170	239	304	329	322	343	329	344	332	303							
11.1	Vc	25	25	30	30	30	30	30	30	30	30						
	fz	0.02	0.03	0.045	0.061	0.057	0.065	0.061	0.068	0.075	0.083						
	RPM	1326	995	955	796	682	597	531	477	434	382						
FEED	106	119	172	194	194	194	195	195	190								
M 14.1	Vc	25	30	30	30	30	30	30	30	30	30						
	fz	0.019	0.029	0.045	0.064	0.059	0.068	0.062	0.071	0.079	0.085						
	RPM	1326	1194	955	796	682	597	531	477	434	382						
FEED	101	138	172	204	201	203	197	203	206	195							
K 15-20	Vc	40	50	45	45	50	50	50	45	45							
	fz	0.02	0.03	0.053	0.069	0.063	0.069	0.062	0.072	0.085	0.088						
	RPM	2122	1989	1432	1194	1023	995	884	796	651	573						
FEED	170	239	304	329	322	343	329	344	332	303							

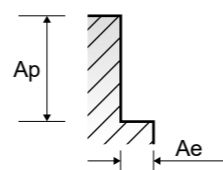

E9A26 SERIES MULTI FLUTE ROUGHING - SIDE CUTTING

Vc = m/min.
fz = mm/tooth
RPM = rev./min.
FEED = mm/min.

ISO	VDI 3323	Material Description	Ae	Ap	Parameter	Diameter (Ø)										
						6.0	8.0	10.0	12.0	14.0	16.0	18.0	20.0	22.0	25.0	
P	1	Non-alloy steel	0.5D	1.5D	Vc	35	40	40	40	40	40	40	40	40	40	40
					fz	0.018	0.028	0.05	0.059	0.056	0.063	0.061	0.067	0.072	0.08	
					RPM	1857	1592	1273	1061	909	796	707	637	579	509	
	FEED		134	178	255	250	255	251	259	256	250	244				
	2		Vc	30	35	30	30	30	35	30	30	30				
			fz	0.018	0.027	0.049	0.063	0.058	0.064	0.056	0.067	0.078	0.081			
			RPM	1592	1393	955	796	682	597	619	477	434	382			
	FEED		115	150	187	201	198	191	208	192	203	186				
	3-4		Vc	20	25	20	25	20	25	25	25	20	20			
			fz	0.017	0.028	0.044	0.058	0.055	0.062	0.057	0.065	0.073	0.08			
			RPM	1061	995	637	663	455	497	442	398	289	255			
FEED	72	111	112	154	125	154	151	155	127	122						
5	Vc	15	20	20	20	20	20	20	20	20	20					
	fz	0.018	0.027	0.042	0.055	0.051	0.059	0.056	0.061	0.068	0.076					
	RPM	796	796	637	531	455	398	354	318	289	255					
FEED	57	86	107	117	116	117	119	117	118	116						
6	Vc	30	35	30	30	30	35	30	30	30	30					
	fz	0.018	0.027	0.049	0.063	0.058	0.064	0.056	0.067	0.078	0.081					
	RPM	1592	1393	955	796	682	597	619	477	434	382					
FEED	115	150	187	201	198	191	208	192	203	186						
7	Vc	20	25	20	25	20	25	25	25	20	20					
	fz	0.017	0.028	0.044	0.058	0.055	0.062	0.057	0.065	0.073	0.08					
	RPM	1061	995	637	663	455	497	442	398	289	255					
FEED	72	111	112	154	125	154	151	155	127	122						
8-9	Vc	15	20	20	20	20	20	20	20	20	20					
	fz	0.018	0.027	0.042	0.055	0.051	0.059	0.056	0.061	0.068	0.076					
	RPM	796	796	637	531	455	398	354	318	289	255					
FEED	57	86	107	117	116	117	119	117	118	116						
10	Vc	30	35	30	30	30	35	30	30	30	30					
	fz	0.018	0.027	0.049	0.063	0.058	0.064	0.056	0.067	0.078	0.081					
	RPM	1592	1393	955	796	682	597	619	477	434	382					
FEED	115	150	187	201	198	191	208	192	203	186						
11.1	Vc	15	20	20	20	20	20	20	20	20	20					
	fz	0.018	0.027	0.042	0.055	0.051	0.059	0.056	0.061	0.068	0.076					
	RPM	796	796	637	531	455	398	354	318	289	255					
FEED	57	86	107	117	116	117	119	117	118	116						
M 14.1	Vc	20	20	20	20	20	20	20	20	20	20					
	fz	0.02	0.03	0.045	0.065	0.06	0.069	0.064	0.073	0.081	0.086					
	RPM	1061	796	637	531	455	398	354	318	289	255					
FEED	85	95	115	138	136	137	136	139	141	131						
K 15-20	Vc	30	35	30	30	30	35	30	30	30	30					
	fz	0.018	0.027	0.049	0.063	0.058	0.064	0.056	0.067	0.078	0.081					
	RPM	1592	1393	955	796	682	597	619	477	434	382					
FEED	115	150	187	201	198	191	208	192	203	186						

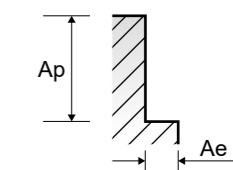

E9E43 SERIES MULTI FLUTE ROUGHING - SIDE CUTTING

Vc = m/min.
fz = mm/tooth
RPM = rev./min.
FEED = mm/min.

ISO	VDI 3323	Material Description	Ae	Ap	Parameter	10.0	12.0	16.0	20.0	25.0
P	1	Non-alloy steel	0.5D	1.5D	Vc	41	41	41	41	41
					fz	0.042	0.05	0.067	0.085	0.081
					RPM	1305	1088	816	653	522
					FEED	219	218	219	222	211
	2		0.5D	1.5D	Vc	32	32	32	32	32
					fz	0.041	0.053	0.068	0.086	0.083
					RPM	1019	849	637	509	407
	3-4		0.5D	1.5D	Vc	23	23	23	23	23
					fz	0.037	0.05	0.067	0.083	0.082
					RPM	732	610	458	366	293
5	0.5D	1.5D	Vc	19	19	19	19	19		
			fz	0.035	0.048	0.064	0.079	0.079		
			RPM	605	504	378	302	242		
6	0.5D	1.5D	Vc	32	32	32	32	32		
			fz	0.041	0.053	0.068	0.086	0.083		
			RPM	1019	849	637	509	407		
7	0.5D	1.5D	Vc	23	23	23	23	23		
			fz	0.037	0.05	0.067	0.083	0.082		
			RPM	732	610	458	366	293		
8	0.5D	1.5D	Vc	19	19	19	19	19		
			fz	0.035	0.048	0.064	0.079	0.079		
			RPM	605	504	378	302	242		
9	0.5D	1.5D	Vc	19	19	19	19	19		
			fz	0.035	0.048	0.064	0.079	0.079		
			RPM	605	504	378	302	242		
10	0.5D	1.5D	Vc	32	32	32	32	32		
			fz	0.041	0.053	0.068	0.086	0.083		
			RPM	1019	849	637	509	407		
11.1	0.5D	1.5D	Vc	19	19	19	19	19		
			fz	0.035	0.048	0.064	0.079	0.079		
			RPM	605	504	378	302	242		
M	14.1	Stainless steel	0.5D	1.5D	Vc	21	21	21	21	21
					fz	0.038	0.058	0.074	0.095	0.089
					RPM	668	557	418	334	267
K	15-20	Grey cast iron Nodular cast iron Malleable cast iron	0.5D	1.5D	Vc	32	32	32	32	32
					fz	0.041	0.053	0.068	0.086	0.083
					RPM	1019	849	637	509	407
					FEED	167	180	173	175	169

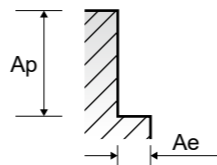

GAE43 SERIES MULTI FLUTE ROUGHING - SIDE CUTTING

Vc = m/min.
fz = mm/tooth
RPM = rev./min.
FEED = mm/min.

ISO	VDI 3323	Material Description	Ae	Ap	Parameter	10.0	12.0	16.0	20.0	25.0
P	1	Non-alloy steel	0.5D	1.5D	Vc	60	60	60	60	60
					fz	0.047	0.055	0.074	0.094	0.09
					RPM	1910	1592	1194	955	764
					FEED	359	350	353	359	344
	2		0.5D	1.5D	Vc	47	47	47	47	47
					fz	0.045	0.058	0.074	0.092	0.09
					RPM	1496	1247	935	748	598
	3-4		0.5D	1.5D	Vc	33	33	33	33	33
					fz	0.039	0.054	0.074	0.092	0.088
					RPM	1050	875	657	525	420
5	0.5D	1.5D	Vc	28	28	28	28	28		
			fz	0.038	0.052	0.07	0.088	0.086		
			RPM	891	743	557	446	357		
6	0.5D	1.5D	Vc	47	47	47	47	47		
			fz	0.045	0.058	0.074	0.092	0.09		
			RPM	1496	1247	935	748	598		
7	0.5D	1.5D	Vc	33	33	33	33	33		
			fz	0.039	0.054	0.074	0.092	0.088		
			RPM	1050	875	657	525	420		
8-9	0.5D	1.5D	Vc	28	28	28	28	28		
			fz	0.038	0.052	0.07	0.088	0.086		
			RPM	891	743	557	446	357		
10	0.5D	1.5D	Vc	47	47	47	47	47		
			fz	0.045	0.058	0.074	0.092	0.09		
			RPM	1496	1247	935	748	598		
11.1	0.5D	High alloyed steel, and tool steel	Vc	28	28	28	28	28		
			fz	0.038	0.052	0.07	0.088	0.086		
			RPM	891	743	557	446	357		
M	14.1	Stainless steel	0.5D	1.5D	Vc	30	30	30	30	30
					fz	0.038	0.055	0.073	0.091	0.087
					RPM	955	796	597	477	382
K	15-20	Grey cast iron Nodular cast iron Malleable cast iron	0.5D	1.5D	Vc	47	47	47	47	47
					fz	0.045	0.058	0.074	0.092	0.09
					RPM	1496	1247	935	748	598
					FEED	269	289	277	275	269

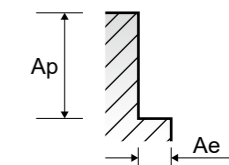



Global Cutting Tool Leader **YG-1**



MILLING



Leading Through Innovation

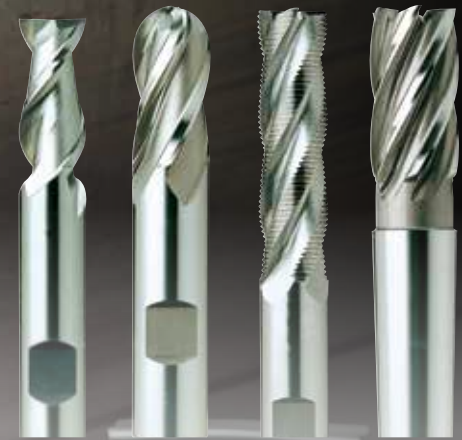

HSS

GENERAL HSS END MILLS HSS SCHAFTFRÄSER

- General Purpose / Coating Available
- Allgemeine Anwendung / Beschichtung verfügbar

SELECTION GUIDE



MILLING TOOLS

SERIES	E2535	E2492	EL612	E2570
FLUTE	2	2	1	2
HELIX ANGLE	30°	30°	≈ 30°	≈ 30°
CUTTING EDGE SHAPE	BALL NOSE	BALL NOSE	SQUARE	SQUARE
SIZE MIN	R1.0	R1.0	D3.0	D1.0
SIZE MAX	R16.0	R15.0	D10.0	D40.0
PAGE	C643	C644	C645	C646

GENERAL HSS END MILLS

General Purpose, Non-coated, Any Coating Available



Please visit globalyg1.com/mat for material search

◎ : Excellent ○ : Good

Recommended cutting conditions : p. C673

ISO	VDI 3323	Material Description	Composition / Structure / Heat Treatment	HB	HRc
P	1	Non-alloy steel	About 0.15% C Annealed	125	
	2		About 0.45% C Annealed	190	13
	3		About 0.45% C Quenched & Tempered	250	25
	4		About 0.75% C Annealed	270	28
	5	About 0.75% C Quenched & Tempered	300	32	
	6	Low alloy steel	Annealed	180	10
	7		Quenched & Tempered	275	29
	8		Quenched & Tempered	300	32
	9		Quenched & Tempered	350	38
	10		High alloyed steel, and tool steel	Annealed	200
	11	Quenched & Tempered	325	35	
M	12	Stainless steel	Ferritic / Martensitic Annealed	200	15
	13		Martensitic Quenched & Tempered	240	23
	14	Austenitic	180	10	
K	15	Grey cast iron	Pearlitic / ferritic	180	10
	16		Pearlitic (Martensitic)	260	26
	17	Nodular cast iron	Ferritic	160	3
	18		Pearlitic	250	25
	19		Ferritic	130	
20	Malleable cast iron	Pearlitic	230	21	
N	21	Aluminum-wrought alloy	Not Curable	60	
	22		Curable Hardened	100	
	23	Aluminum-cast, alloyed	≤ 12% Si, Not Curable	75	
	24		≤ 12% Si, Curable Hardened	90	
	25		> 12% Si, Not Curable	130	
	26	Copper and Copper Alloys (Bronze / Brass)	Cutting Alloys, PB>1%	110	
	27		CuZn, CuSnZn (Brass)	90	
	28	Non Metallic Materials	CuSn, lead-free copper and electrolytic copper	100	
	29		Duroplastic, Fiber Reinforced Plastic		
30	Rubber, Wood, etc.				
S	31	Heat Resistant Super Alloys	Fe Based Annealed	200	15
	32		Cured	280	30
	33		Annealed	250	25
	34		Ni or Co Based Cured	350	38
	35	Cast	320	34	
	36	Titanium Alloys	Pure Titanium	400 Rm	
37	Alpha + Beta Alloys Hardened		1050 Rm		
H	38	Hardened steel	Hardened	550	55
	39		Hardened	630	60
	40	Hardened Cast Iron	Cast	400	42
	41		Hardened	550	55



HSS

E2571	E2510	E2464	E2509	E2572	E2573	E2516	E2553	E2SET553	E2554	E2574	E2595
2	2	2	2	3	3	3	3	3	3	4	4
≈ 30°	30°	42°	42°	≈ 30°	≈ 30°	30°	30°	30°	30°	≈ 30°	≈ 30°
SQUARE	SQUARE	SQUARE	SQUARE	SQUARE	SQUARE	SQUARE	SQUARE	SQUARE	SQUARE	SQUARE	SQUARE
D1.5	D2.5	D1.0	D2.0	D1.5	D1.0	D2.0	D1.0	D2.0	D1.5	D2.0	D2.0
D40.0	D40.0	D32.0	D20.0	D32.0	D40.0	D40.0	D20.0	D10.0	D10.0	D20.0	D25.0
C649	C651	C653	C654	C655	C656	C658	C660	C661	C662	C663	C664
LONG LENGTH	EXTRA LONG LENGTH	SHORT LENGTH	LONG LENGTH	STUB LENGTH	SHORT LENGTH	LONG LENGTH	SHORT LENGTH THROW AWAY	THROW AWAY SET	LONG LENGTH THROW AWAY	SHORT LENGTH	SHORT LENGTH CENTER CUTTING
Uncoated / TiAlN	Uncoated / TiAlN	Uncoated	Uncoated	Uncoated / TiAlN	Uncoated / TiAlN	Uncoated / TiAlN	Uncoated / TiAlN	Uncoated	Uncoated / TiAlN	Uncoated / TiAlN	Uncoated / TiAlN
HSS Co8	HSS Co8	HSS Co8	HSS Co8	HSS Co8	HSS Co8	HSS Co8	HSS Co8	HSS Co8	HSS Co8	HSS Co8	HSS Co8



SELECTION GUIDE



SERIES	E2597	E2753	E2762	E2755	E2751	E2752
FLUTE	4	Multi Flute	Multi Flute	3	Multi Flute	Multi Flute
HELIX ANGLE	45°	30°	30°	37°	30°	30°
SIZE MIN	D2.0	D6.0	D6.0	D6.0	D6.0	D6.0
SIZE MAX	D20.0	D40.0	D40.0	D30.0	D50.0	D40.0
PAGE	C665	C666	C667	C668	C669	C671

MILLING TOOLS

GENERAL HSS END MILLS

General Purpose, Non-coated, Any Coating Available

◎ : Excellent ○ : Good

Recommended cutting conditions : p. C673

Please visit globalyg1.com/mat for material search



ISO	VDI 3323	Material Description	HB	HRc	E2597	E2753	E2762	E2755	E2751	E2752	
P	1	Non-alloy steel	125		◎	◎	◎	◎	◎	◎	
	2		190	13	◎	◎	◎	◎	◎	◎	
	3		250	25	◎	◎	◎	○	◎	◎	
	4		270	28	◎	◎	◎	○	◎	◎	
	5		300	32	◎	◎	◎	○	◎	◎	
	6	180	10	◎	◎	◎	◎	◎	◎	◎	
	7	275	29	◎	◎	◎	○	◎	◎	◎	
	8	300	32	◎	◎	◎	○	◎	◎	◎	
	9	350	38	○	○	○		○	○	○	
	10	High alloyed steel, and tool steel	200	15	◎	◎	◎	◎	◎	◎	
	11		325	35	○	○	○		○	○	
M	12	Stainless steel	200	15							
	13		240	23							
	14		180	10							
K	15	Grey cast iron	180	10							
	16		260	26							
	17	Nodular cast iron	160	3							
	18		250	25							
	19		130								
20	Malleable cast iron	230	21								
N	21	Aluminum-wrought alloy	60		○	○	○	◎	○	○	
	22		100		○	○	○	◎	○	○	
	23	Aluminum-cast, alloyed	75		○	○	○	◎	○	○	
	24		90		○	○	○	◎	○	○	
	25		130		○	○	○	○	○	○	
	26		110								
	27		90								
	28	Copper and Copper Alloys (Bronze / Brass)	100								
	29	Non Metallic Materials									
	30										
S	31	Heat Resistant Super Alloys	200	15							
	32		280	30							
	33		250	25							
	34		350	38							
	35		320	34							
36	Titanium Alloys	400 Rm									
37		1050 Rm									
H	38	Hardened steel	550	55							
	39		630	60							
	40	Chilled Cast Iron	400	42							
	41	Hardened Cast Iron	550	55							



FLAT SHANK E2535 SERIES
FLAT SHANK EQ535 SERIES

HSSCo8, 2 FLUTE SHORT LENGTH BALL NOSE

HSSCo8, 2 SCHNEIDEN KURZ STIRNRADIUS
Fraise HSSCo8, 2 dents, hémisphérique, courte
2 TAGLIENTI, SEMISFERICA, SERIE CORTA - HSSCo8



HSS Co8 DIN 327 2 30° ±0.02
DIN 1835B UNCOATED TiAlN

p.C673-674

Flat Shank	Page	Plain Shank	Page
END MILL HOLDER	D118 - 137	POWER MILLING CHUCK	D161 - 176
		ER COLLET CHUCK	D73 - 116
		SK SLIM CHUCK	D183 - 201

Unit : mm

EDP No.	Radius of Ball Nose R (±0.02)	Mill Diameter	Shank Diameter h6	Length of Cut	Overall Length	
						UNCOATED
E2535020	EQ535020	R1.0	2.0	6	4	48
E2535025	EQ535025	R1.25	2.5	6	5	49
E2535030	EQ535030	R1.5	3.0	6	5	49
E2535035	EQ535035	R1.75	3.5	6	6	50
E2535040	EQ535040	R2.0	4.0	6	7	51
E2535045	EQ535045	R2.25	4.5	6	7	51
E2535050	EQ535050	R2.5	5.0	6	8	52
E2535055	EQ535055	R2.75	5.5	6	8	52
E2535060	EQ535060	R3.0	6.0	6	8	52
E2535070	EQ535070	R3.5	7.0	10	10	60
E2535080	EQ535080	R4.0	8.0	10	11	61
E2535090	EQ535090	R4.5	9.0	10	11	61
E2535100	EQ535100	R5.0	10.0	10	13	63
E2535110	EQ535110	R5.5	11.0	12	13	70
E2535120	EQ535120	R6.0	12.0	12	16	73
E2535130	EQ535130	R6.5	13.0	12	16	73
E2535140	EQ535140	R7.0	14.0	12	16	73
E2535150	EQ535150	R7.5	15.0	12	16	73
E2535160	EQ535160	R8.0	16.0	16	19	79
E2535170	EQ535170	R8.5	17.0	16	19	79
E2535180	EQ535180	R9.0	18.0	16	19	79
E2535190	EQ535190	R9.5	19.0	16	19	79
E2535200	EQ535200	R10.0	20.0	16	22	82
E2535210	EQ535210	R10.0	20.0	20	22	88
E2535220	EQ535220	R11.0	22.0	20	22	88
E2535230	EQ535230	R11.0	22.0	25	22	98
E2535240	EQ535240	R12.0	24.0	25	26	102
E2535250	EQ535250	R12.5	25.0	25	26	102
E2535260	EQ535260	R13.0	26.0	25	26	102
E2535280	EQ535280	R14.0	28.0	25	26	102
E2535300	EQ535300	R15.0	30.0	25	26	102
E2535320	EQ535320	R16.0	32.0	32	32	112

Mill Dia. Tolerance (mm)	Shank Dia. Tolerance
0 ~ - 0.03	h6

Other shank design on your request.
TiN and TiCN Coatings are available on your request.

◎ : Excellent ○ : Good

ISO	P									M				K						
	Non-alloy steel					Low alloy steel				High alloyed steel, and tool steel				Stainless steel		Grey cast iron		Nodular cast iron		Malleable cast iron
Material Description	1	2	3	4	5	6	7	8	9	10	11	12	13	14	15	16	17	18	19	20
VDI 3323	1	2	3	4	5	6	7	8	9	10	11	12	13	14	15	16	17	18	19	20
HRc	13	25	28	32	30	29	32	38	35	35	35	15	23	10	10	26	3	25	21	21
HB	125	190	250	270	300	180	275	300	350	200	325	200	240	180	180	260	160	250	130	230
Recommend	◎	◎	◎	◎	◎	◎	◎	○	○	◎	○									

ISO	N					S					H										
	Aluminum-wrought alloy		Aluminum-cast, alloyed			Copper and Copper Alloys (Bronze / Brass)		Non Metallic Materials			Heat Resistant Super Alloys		Titanium Alloys	Hardened steel	Chilled Cast Iron	Hardened Cast Iron					
Material Description	21	22	23	24	25	26	27	28	29	30	31	32	33	34	35	36	37	38	39	40	41
VDI 3323	21	22	23	24	25	26	27	28	29	30	31	32	33	34	35	36	37	38	39	40	41
HRc	15	30	25	38	34						200	260	250	350	320	400 Rm	1050 Rm	550	630	400	550
HB	60	100	75	90	130	110	90	100													
Recommend	○	○	○	○	○																



FLAT SHANK **E2492** SERIES
FLAT SHANK **EQ492** SERIES

HSSCo8, 2 FLUTE LONG LENGTH BALL NOSE

- HSSCo8, 2 SCHNEIDEN LANG STIRNRADIUS
- Fraise HSSCo8, 2 dents, hémisphérique, longue
- 2 TAGLIENTI, SEMISFERICA, SERIE LUNGA - HSSCo8



HSS Co8 DIN 1889 2 30° R ±0.02
DIN 1835B UNCOATED TiAlN p.C673-674

Flat Shank	Page	Plain Shank	Page
END MILL HOLDER	D118-137	POWER MILLING CHUCK	D161-176
		ER COLLET CHUCK	D73-116
		SK SLIM CHUCK	D183-201

Unit : mm

EDP No.	Radius of Ball Nose R (±0.02)	Mill Diameter	Shank Diameter h6	Length of Cut	Overall Length	
						UNCOATED
E2492020	EQ492020	R1.0	2.0	6	7	54
E2492030	EQ492030	R1.5	3.0	6	8	56
E2492040	EQ492040	R2.0	4.0	6	11	63
E2492050	EQ492050	R2.5	5.0	6	13	68
E2492060	EQ492060	R3.0	6.0	6	13	68
E2492070	EQ492070	R3.5	7.0	10	16	80
E2492080	EQ492080	R4.0	8.0	10	19	88
E2492090	EQ492090	R4.5	9.0	10	19	88
E2492100	EQ492100	R5.0	10.0	10	22	95
E2492110	EQ492110	R5.5	11.0	12	22	102
E2492120	EQ492120	R6.0	12.0	12	26	110
E2492130	EQ492130	R6.5	13.0	12	26	110
E2492140	EQ492140	R7.0	14.0	12	26	110
E2492150	EQ492150	R7.5	15.0	12	26	110
E2492160	EQ492160	R8.0	16.0	16	32	123
E2492170	EQ492170	R8.5	17.0	16	32	123
E2492180	EQ492180	R9.0	18.0	16	32	123
E2492190	EQ492190	R9.5	19.0	16	32	123
E2492200	EQ492200	R10.0	20.0	20	38	141
E2492220	EQ492220	R11.0	22.0	20	38	141
E2492240	EQ492240	R12.0	24.0	25	45	166
E2492250	EQ492250	R12.5	25.0	25	45	166
E2492260	EQ492260	R13.0	26.0	25	45	166
E2492280	EQ492280	R14.0	28.0	25	45	166
E2492300	EQ492300	R15.0	30.0	25	45	166

- ▶ Other shank design on your request.
- ▶ TiN and TiCN Coatings are available on your request.

Mill Dia. Tolerance (mm)	Shank Dia. Tolerance
0 ~ - 0.03	h6

◎ : Excellent ○ : Good

ISO Material Description	P										M				K					
	Non-alloy steel					Low alloy steel					High alloyed steel, and tool steel		Stainless steel		Grey cast iron	Nodular cast iron	Malleable cast iron			
VDI 3323	1	2	3	4	5	6	7	8	9	10	11	12	13	14	15	16	17	18	19	20
HRc	13	25	28	32	30	10	29	32	38	15	35	15	23	10	10	26	3	25	21	21
HB	125	190	250	270	300	180	275	300	350	200	325	200	240	180	180	260	160	250	130	230
Recommend	◎	◎	◎	◎	◎	◎	◎	○	○	◎	○	○	○	○	○	○	○	○	○	○

ISO Material Description	N					S					H										
	Aluminum-wrought alloy		Aluminum-cast, alloyed		Copper and Copper Alloys (Bronze / Brass)	Non Metallic Materials		Heat Resistant Super Alloys			Titanium Alloys		Hardened steel	Chilled Cast Iron	Hardened Cast Iron						
VDI 3323	21	22	23	24	25	26	27	28	29	30	31	32	33	34	35	36	37	38	39	40	41
HRc	21	22	23	24	25	26	27	28	29	30	31	32	33	34	35	36	37	38	39	40	41
HB	60	100	75	90	130	110	90	100			200	280	250	350	320	400 Rm	1050 Rm	550	630	400	550
Recommend	○	○	○	○	○	○	○	○	○	○	○	○	○	○	○	○	○	○	○	○	○



PLAIN SHANK **EL612** SERIES

HSS-E, 1 FLUTE for ALUMINUM

- HSS-E, 1 SCHNEIDEN für ALUMINIUM
- Fraise HSS-E, 1 dent pour aluminium
- 1 TAGLIENTE - HSS-E

for ALUMINIUM für ALUMINIUM



HSS-E YG STD 1 30° UNCOATED p.C675

Flat Shank	Page	Plain Shank	Page
END MILL HOLDER	D118-137	POWER MILLING CHUCK	D161-176
		ER COLLET CHUCK	D73-116
		SK SLIM CHUCK	D183-201

Unit : mm

EDP No.	Mill Diameter	Shank Diameter	Length of Cut	Overall Length
UNCOATED	js14	h6		
EL612030	3.0	8	12	60
EL612040	4.0	8	12	60
EL612050	5.0	8	12	60
EL612060	6.0	8	14	60
EL612070	7.0	8	14	60
EL612080	8.0	8	14	80
EL612090	9.0	8	14	80
EL612100	10.0	8	14	80

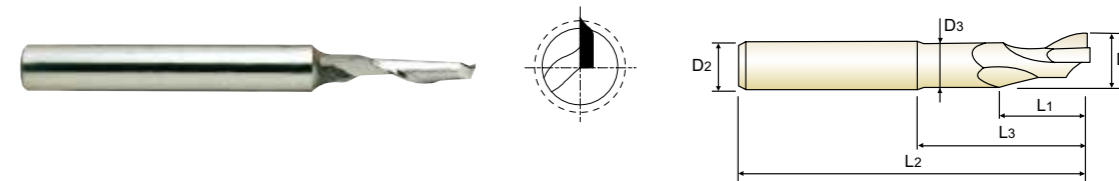

Unit : mm

EDP No.	Mill Diameter	Shank Diameter	Length of Cut	Length Below Shank	Overall Length	Neck Diameter
UNCOATED	D1(js14)	D2(h6)	L1	L3	L2	L2
EL612904	5.0	8	18	35	80	4.8
EL612909	5.0	8	40	-	100	-
EL612932	8.0	8	14	68	120	7.5

Tolerances according to DIN 7160 & 7161

	Tolerance range in μm					
	Nominal-Diameter in mm					
	from 1 to 3	over 3 to 6	over 6 to 10	over 10 to 18	over 18 to 30	over 30 to 50
js14	±125	±150	±180	±215	±260	±310
h6	0 -6	0 -8	0 -9	0 -11	0 -13	0 -16

◎ : Excellent ○ : Good

ISO Material Description	P										M				K					
	Non-alloy steel					Low alloy steel					High alloyed steel, and tool steel		Stainless steel		Grey cast iron	Nodular cast iron	Malleable cast iron			
VDI 3323	1	2	3	4	5	6	7	8	9	10	11	12	13	14	15	16	17	18	19	20
HRc	13	25	28	32	30	10	29	32	38	15	35	15	23	10	10	26	3	25	21	21
HB	125	190	250	270	300	180	275	300	350	200	325	200	240	180	180	260	160	250	130	230
Recommend	○	○	○	○	○	○	○	○	○	○	○	○	○	○	○	○	○	○	○	○

ISO Material Description	N					S					H										
	Aluminum-wrought alloy		Aluminum-cast, alloyed		Copper and Copper Alloys (Bronze / Brass)	Non Metallic Materials		Heat Resistant Super Alloys			Titanium Alloys		Hardened steel	Chilled Cast Iron	Hardened Cast Iron						
VDI 3323	21	22	23	24	25	26	27	28	29	30	31	32	33	34	35	36	37	38	39	40	41
HRc	21	22	23	24	25	26	27	28	29	30	31	32	33	34	35	36	37	38	39	40	41
HB	60	100	75	90	130	110	90	100			200	280	250	350	320	400 Rm	1050 Rm	550	630	400	550
Recommend	○	○	○	○	○	○	○	○	○	○	○	○	○	○	○	○	○	○	○	○	○



FLAT SHANK E2570 SERIES
FLAT SHANK EQ570 SERIES

HSSCo8, 2 FLUTE SHORT LENGTH

- HSSCo8, 2 SCHNEIDEN KURZ
- Fraise HSSCo8, 2 dents, courte
- 2 TAGLIENTI, SERIE CORTA - HSSCo8



HSS Co8
DIN 327
2
30°
DIN 1835B
UNCOATED
TiAlN
p.C676-679

Flat Shank	Page	Plain Shank	Page
END MILL HOLDER	D118-137	POWER MILLING CHUCK	D161-176
		ER COLLET CHUCK	D73-116
		SK SLIM CHUCK	D183-201

Unit : mm

EDP No.	Mill Diameter		Shank Diameter	Length of Cut	Overall Length
	UNCOATED	TiAlN			
E2570010	EQ570010	1.0	6	2.5	47
E2570015	EQ570015	1.5	6	3	47
E2570020	EQ570020	2.0	6	4	48
E2570025	EQ570025	2.5	6	5	49
E2570028	EQ570028	2.8	6	5	49
E2570030	EQ570030	3.0	6	5	49
E2570035	EQ570035	3.5	6	6	50
E2570038	EQ570038	3.8	6	7	51
E2570040	EQ570040	4.0	6	7	51
E2570045	EQ570045	4.5	6	7	51
E2570048	EQ570048	4.8	6	8	52
E2570050	EQ570050	5.0	6	8	52
E2570055	EQ570055	5.5	6	8	52
E2570957	EQ570957	5.8	6	8	52
E2570060	EQ570060	6.0	6	8	52
E2570065	EQ570065	6.5	10	10	60
E2570967	EQ570967	6.8	10	10	60
E2570070	EQ570070	7.0	10	10	60
E2570075	EQ570075	7.5	10	10	60
E2570977	EQ570977	7.8	10	11	61
E2570080	EQ570080	8.0	10	11	61
E2570085	EQ570085	8.5	10	11	61
E2570087	EQ570087	8.7	10	11	61
E2570090	EQ570090	9.0	10	11	61

Tolerances according to DIN 7160 & 7161

- ▶ Other shank design on your request. ▶ NEXT PAGE
- ▶ TiN and TiCN Coatings are available on your request.

	Tolerance range in μm					
	Nominal-Diameter in mm					
	from 1 to 3	over 3 to 6	over 6 to 10	over 10 to 18	over 18 to 30	over 30 to 50
e8	-14 -28	-20 -38	-25 -47	-32 -59	-40 -73	-50 -89
h6	0 -6	0 -8	0 -9	0 -11	0 -13	0 -16

◎ : Excellent ○ : Good

ISO Material Description	P										M				K																												
	Non-alloy steel					Low alloy steel					High alloyed steel, and tool steel				Stainless steel		Grey cast iron		Nodular cast iron			Malleable cast iron																					
VDI 3323	1	2	3	4	5	6	7	8	9	10	11	12	13	14	15	16	17	18	19	20	21	22	23	24	25	26	27	28	29	30	31	32	33	34	35	36	37	38	39	40	41		
HRc	13	25	28	32	30	10	29	32	38	15	35	15	23	10	10	26	3	25	21	21	15	30	25	38	34	200	325	200	350	200	280	250	350	320	400 Rm	1050 Rm	550	630	400	550			
HB	125	190	250	270	300	180	275	300	350	200	325	200	240	180	180	260	160	250	130	230	180	260	160	250	130	230																	
Recommend	◎	◎	◎	◎	◎	◎	◎	◎	◎	◎	◎	◎	◎	◎	◎	◎	◎	◎	◎	◎	◎	◎	◎	◎	◎	◎	◎	◎	◎	◎	◎	◎	◎	◎	◎	◎	◎	◎	◎	◎	◎	◎	◎



FLAT SHANK E2570 SERIES
FLAT SHANK EQ570 SERIES

HSSCo8, 2 FLUTE SHORT LENGTH

- HSSCo8, 2 SCHNEIDEN KURZ
- Fraise HSSCo8, 2 dents, courte
- 2 TAGLIENTI, SERIE CORTA - HSSCo8



HSS Co8
DIN 327
2
30°
DIN 1835B
UNCOATED
TiAlN
p.C676-679

Flat Shank	Page	Plain Shank	Page
END MILL HOLDER	D118-137	POWER MILLING CHUCK	D161-176
		ER COLLET CHUCK	D73-116
		SK SLIM CHUCK	D183-201

Unit : mm

EDP No.	Mill Diameter		Shank Diameter	Length of Cut	Overall Length
	UNCOATED	TiAlN			
E2570095	EQ570095	9.5	10	11	61
E2570097	EQ570097	9.7	10	13	63
E2570100	EQ570100	10.0	10	13	63
E2570105	EQ570105	10.5	12	13	70
E2570107	EQ570107	10.7	12	13	70
E2570110	EQ570110	11.0	12	13	70
E2570115	EQ570115	11.5	12	13	70
E2570117	EQ570117	11.7	12	16	73
E2570120	EQ570120	12.0	12	16	73
E2570125	EQ570125	12.5	12	16	73
E2570127	EQ570127	12.7	12	16	73
E2570130	EQ570130	13.0	12	16	73
E2570135	EQ570135	13.5	12	16	73
E2570137	EQ570137	13.7	12	16	73
E2570140	EQ570140	14.0	12	16	73
E2570147	EQ570147	14.7	12	16	73
E2570150	EQ570150	15.0	12	16	73
E2570157	EQ570157	15.7	16	19	79
E2570160	EQ570160	16.0	16	19	79
E2570167	EQ570167	16.7	16	19	79
E2570170	EQ570170	17.0	16	19	79
E2570177	EQ570177	17.7	16	19	79
E2570180	EQ570180	18.0	16	19	79
E2570190	EQ570190	19.0	16	19	79

Tolerances according to DIN 7160 & 7161

- ▶ Other shank design on your request. ▶ NEXT PAGE
- ▶ TiN and TiCN Coatings are available on your request.

	Tolerance range in μm					
	Nominal-Diameter in mm					
	from 1 to 3	over 3 to 6	over 6 to 10	over 10 to 18	over 18 to 30	over 30 to 50
e8	-14 -28	-20 -38	-25 -47	-32 -59	-40 -73	-50 -89
h6	0 -6	0 -8	0 -9	0 -11	0 -13	0 -16

◎ : Excellent ○ : Good

ISO Material Description	P										M				K																											
	Non-alloy steel					Low alloy steel					High alloyed steel, and tool steel				Stainless steel		Grey cast iron		Nodular cast iron			Malleable cast iron																				
VDI 3323	1	2	3	4	5	6	7	8	9	10	11	12	13	14	15	16	17	18	19	20	21	22	23	24	25	26	27	28	29	30	31	32	33	34	35	36	37	38	39	40	41	
HRc	13	25	28	32	30	10	29	32	38	15	35	15	23	10	10	26	3	25	21	21	15	30	25	38	34	200	325	200	350	200	280	250	350	320	400 Rm	1050 Rm	550	630	400	550		
HB	125	190	250	270	300	180	275	300	350	200	325	200	240	180	180	260	160	250	130	230	180	260	160	250	130	230																
Recommend	◎	◎	◎	◎	◎	◎	◎	◎	◎	◎	◎	◎	◎	◎	◎	◎	◎	◎	◎	◎	◎	◎	◎	◎	◎	◎	◎	◎	◎	◎	◎	◎	◎	◎	◎	◎	◎	◎	◎	◎	◎	◎



FLAT SHANK **E2570** SERIES

FLAT SHANK **EQ570** SERIES

HSSCo8, 2 FLUTE SHORT LENGTH

- HSSCo8, 2 SCHNEIDEN KURZ
- Fraise HSSCo8, 2 dents, courte
- 2 TAGLIENTI, SERIE CORTA - HSSCo8



p.C676-679



Flat Shank	Page	Plain Shank	Page
END MILL HOLDER D118-137		POWER MILLING CHUCK D161-176	
		ER COLLET CHUCK D73-116	
		SK SLIM CHUCK D183-201	

Unit : mm

EDP No.	Mill Diameter		Shank Diameter	Length of Cut	Overall Length
	UNCOATED	TiAlN			
E2570197	19.7	20	22	88	
E2570920	20.0	16	22	82	
E2570200	20.0	20	22	88	
E2570210	20.0	20	22	88	
E2570220	20.0	20	22	88	
E2570922	22.0	25	22	98	
E2570240	24.0	25	26	102	
E2570250	25.0	25	26	102	
E2570260	26.0	25	26	102	
E2570270	27.0	25	26	102	
E2570280	28.0	25	26	102	
E2570290	29.0	25	26	102	
E2570300	30.0	25	26	102	
E2570320	32.0	32	32	112	
E2570340	34.0	32	32	112	
E2570350	35.0	32	32	112	
E2570360	36.0	32	32	112	
E2570380	38.0	32	38	118	
E2570938	38.0	40	38	130	
E2570400	40.0	32	38	118	
E2570903	40.0	40	38	130	

- ▶ Other shank design on your request.
- ▶ TiN and TiCN Coatings are available on your request.

Tolerances according to DIN 7160 & 7161

	Tolerance range in μm					
	Nominal-Diameter in mm					
	from 1 to 3	over 3 to 6	over 6 to 10	over 10 to 18	over 18 to 30	over 30 to 50
e8	-14 -28	-20 -38	-25 -47	-32 -59	-40 -73	-50 -89
h6	0 -6	0 -8	0 -9	0 -11	0 -13	0 -16

◎ : Excellent ○ : Good

ISO	P										M				K																													
	Non-alloy steel					Low alloy steel					High alloyed steel, and tool steel				Stainless steel		Grey cast iron		Nodular cast iron			Malleable cast iron																						
Material Description	1	2	3	4	5	6	7	8	9	10	11	12	13	14	15	16	17	18	19	20	21	22	23	24	25	26	27	28	29	30	31	32	33	34	35	36	37	38	39	40	41			
VDI 3323	1	2	3	4	5	6	7	8	9	10	11	12	13	14	15	16	17	18	19	20	21	22	23	24	25	26	27	28	29	30	31	32	33	34	35	36	37	38	39	40	41			
HRc	125	13	25	28	32	10	29	32	38	15	35	15	23	10	10	26	3	25	21	21	21	21	21	21	21	21	21	21	21	21	21	21	21	21	21	21	21	21	21	21	21			
HB	125	190	250	270	300	180	275	300	350	200	325	200	240	180	180	260	160	250	130	230	230	230	230	230	230	230	230	230	230	230	230	230	230	230	230	230	230	230	230	230	230	230		
Recommend	◎	◎	◎	◎	◎	◎	◎	◎	◎	◎	◎	◎	◎	◎	◎	◎	◎	◎	◎	◎	◎	◎	◎	◎	◎	◎	◎	◎	◎	◎	◎	◎	◎	◎	◎	◎	◎	◎	◎	◎	◎	◎	◎	◎



FLAT SHANK **E2571** SERIES

FLAT SHANK **EQ571** SERIES

HSSCo8, 2 FLUTE LONG LENGTH

- HSSCo8, 2 SCHNEIDEN LANG
- Fraise HSSCo8, 2 dents, longue
- 2 TAGLIENTI, SERIE LUNGA - HSSCo8



p.C676-679



Flat Shank	Page	Plain Shank	Page
END MILL HOLDER D118-137		POWER MILLING CHUCK D161-176	
		ER COLLET CHUCK D73-116	
		SK SLIM CHUCK D183-201	

Unit : mm

EDP No.	Mill Diameter		Shank Diameter	Length of Cut	Overall Length
	UNCOATED	TiAlN			
E2571015	1.5	6	7	51	
E2571020	2.0	6	7	51	
E2571025	2.5	6	8	52	
E2571030	3.0	6	8	52	
E2571035	3.5	6	10	54	
E2571040	4.0	6	11	55	
E2571045	4.5	6	11	55	
E2571050	5.0	6	13	57	
E2571055	5.5	6	13	57	
E2571060	6.0	6	13	57	
E2571065	6.5	10	16	66	
E2571070	7.0	10	16	66	
E2571075	7.5	10	16	66	
E2571080	8.0	10	19	69	
E2571085	8.5	10	19	69	
E2571090	9.0	10	19	69	
E2571095	9.5	10	19	69	
E2571100	10.0	10	22	72	
E2571110	11.0	12	22	79	
E2571120	12.0	12	26	83	
E2571130	13.0	12	26	83	
E2571140	14.0	12	26	83	
E2571150	15.0	12	26	83	
E2571160	16.0	16	32	92	

- ▶ Other shank design on your request.
- ▶ TiN and TiCN Coatings are available on your request.

Tolerances according to DIN 7160 & 7161

	Tolerance range in μm					
	Nominal-Diameter in mm					
	from 1 to 3	over 3 to 6	over 6 to 10	over 10 to 18	over 18 to 30	over 30 to 50
e8	-14 -28	-20 -38	-25 -47	-32 -59	-40 -73	-50 -89
h6	0 -6	0 -8	0 -9	0 -11	0 -13	0 -16

◎ : Excellent ○ : Good

ISO	P										M				K																													
	Non-alloy steel					Low alloy steel					High alloyed steel, and tool steel				Stainless steel		Grey cast iron		Nodular cast iron			Malleable cast iron																						
Material Description	1	2	3	4	5	6	7	8	9	10	11	12	13	14	15	16	17	18	19	20	21	22	23	24	25	26	27	28	29	30	31	32	33	34	35	36	37	38	39	40	41			
VDI 3323	1	2	3	4	5	6	7	8	9	10	11	12	13	14	15	16	17	18	19	20	21	21	21	21	21	21	21	21	21	21	21	21	21	21	21	21	21	21	21	21	21	21		
HRc	125	13	25	28	32	10	29	32	38	15	35	15	23	10	10	26	3	25	21	21	21	21	21	21	21	21	21	21	21	21	21	21	21	21	21	21	21	21	21	21	21			
HB	125	190	250	270	300	180	275	300	350	200	325	200	240	180	180	260	160	250	130	230	230	230	230	230	230	230	230	230	230	230	230	230	230	230	230	230	230	230	230	230	230	230		
Recommend	◎	◎	◎	◎	◎	◎	◎	◎	◎	◎	◎	◎	◎	◎	◎	◎	◎	◎	◎	◎	◎	◎	◎	◎	◎	◎	◎	◎	◎	◎	◎	◎	◎	◎	◎	◎	◎	◎	◎	◎	◎	◎	◎	◎



FLAT SHANK **E2571** SERIES
 FLAT SHANK **EQ571** SERIES

HSSCo8, 2 FLUTE LONG LENGTH

● **HSSCo8, 2 SCHNEIDEN LANG**
 (●) **Fraise HSSCo8, 2 dents, longue**
 (●) **2 TAGLIENTI, SERIE LUNGA - HSSCo8**



Flat Shank	Page	Plain Shank	Page
END MILL HOLDER D118-137		POWER MILLING CHUCK D161-176	
		ER COLLET CHUCK D73-116	
		SK SLIM CHUCK D183-201	

p.C676-679



Unit : mm

EDP No.	Mill Diameter	Shank Diameter		Length of Cut	Overall Length
		e8	h6		
UNCOATED	TiAlN				
E2571180	EQ571180	18.0	16	32	92
E2571200	EQ571200	20.0	20	38	104
E2571220	EQ571220	22.0	20	38	104
E2571240	EQ571240	24.0	25	45	121
E2571250	EQ571250	25.0	25	45	121
E2571260	EQ571260	26.0	25	45	121
E2571270	EQ571270	27.0	25	45	121
E2571280	EQ571280	28.0	25	45	121
E2571300	EQ571300	30.0	25	45	121
E2571320	EQ571320	32.0	32	53	133
E2571400	EQ571400	40.0	40	63	155

▶ Other shank design on your request.
 ▶ TiN and TiCN Coatings are available on your request.

Tolerances according to DIN 7160 & 7161

	Tolerance range in μm					
	Nominal-Diameter in mm					
	from 1 to 3	over 3 to 6	over 6 to 10	over 10 to 18	over 18 to 30	over 30 to 50
e8	-14 -28	-20 -38	-25 -47	-32 -59	-40 -73	-50 -89
h6	0 -6	0 -8	0 -9	0 -11	0 -13	0 -16

◎ : Excellent ○ : Good

ISO	P										M				K					
	Non-alloy steel					Low alloy steel					High alloyed steel, and tool steel		Stainless steel		Grey cast iron		Nodular cast iron		Malleable cast iron	
Material Description	1	2	3	4	5	6	7	8	9	10	11	12	13	14	15	16	17	18	19	20
VDI 3323	1	2	3	4	5	6	7	8	9	10	11	12	13	14	15	16	17	18	19	20
HRc	13	25	28	32	38	42	48	52	58	62	68	72	78	82	88	92	98	102	108	112
HB	125	190	250	270	300	180	275	300	350	200	325	200	240	180	180	260	160	250	130	230
Recommend	◎	◎	◎	◎	◎	◎	◎	◎	◎	◎	◎	◎	◎	◎	◎	◎	◎	◎	◎	◎



FLAT SHANK **E2510** SERIES
 FLAT SHANK **EQ510** SERIES

HSSCo8, 2 FLUTE EXTRA LONG LENGTH

● **HSSCo8, 2 SCHNEIDEN EXTRA LANG**
 (●) **Fraise HSSCo8, 2 dents, extra-longue**
 (●) **2 TAGLIENTI, SERIE EXTRA LUNGA - HSSCo8**

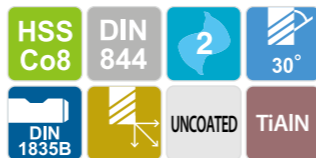

Flat Shank	Page	Plain Shank	Page
END MILL HOLDER D118-137		POWER MILLING CHUCK D161-176	
		ER COLLET CHUCK D73-116	
		SK SLIM CHUCK D183-201	

p.C676-679



Unit : mm

EDP No.	Mill Diameter	Shank Diameter		Length of Cut	Overall Length
		e8	h6		
UNCOATED	TiAlN				
E2510025	EQ510025	2.5	6	8	56
E2510030	EQ510030	3.0	6	8	56
E2510035	EQ510035	3.5	6	10	59
E2510040	EQ510040	4.0	6	11	63
E2510045	EQ510045	4.5	6	11	63
E2510050	EQ510050	5.0	6	13	68
E2510055	EQ510055	5.5	6	13	68
E2510060	EQ510060	6.0	6	13	68
E2510065	EQ510065	6.5	10	16	80
E2510070	EQ510070	7.0	10	16	80
E2510080	EQ510080	8.0	10	19	88
E2510085	EQ510085	8.5	10	19	88
E2510090	EQ510090	9.0	10	19	88
E2510100	EQ510100	10.0	10	22	95
E2510120	EQ510120	12.0	12	26	110
E2510140	EQ510140	14.0	12	26	110
E2510160	EQ510160	16.0	16	32	123
E2510180	EQ510180	18.0	16	32	123
E2510200	EQ510200	20.0	20	38	141
E2510220	EQ510220	22.0	20	38	141
E2510240	EQ510240	24.0	25	45	166
E2510250	EQ510250	25.0	25	45	166
E2510260	EQ510260	26.0	25	45	166
E2510280	EQ510280	28.0	25	45	166
E2510300	EQ510300	30.0	25	45	166
E2510320	EQ510320	32.0	32	53	186
E2510360	EQ510360	36.0	32	53	186
E2510400	EQ510400	40.0	32	63	207
E2510940	EQ510940	40.0	40	63	217

Tolerances according to DIN 7160 & 7161

	Tolerance range in μm					
	Nominal-Diameter in mm					
	from 1 to 3	over 3 to 6	over 6 to 10	over 10 to 18	over 18 to 30	over 30 to 50
e8	-14 -28	-20 -38	-25 -47	-32 -59	-40 -73	-50 -89
h6	0 -6	0 -8	0 -9	0 -11	0 -13	0 -16

◎ : Excellent ○ : Good

ISO	P										M				K					
	Non-alloy steel					Low alloy steel					High alloyed steel, and tool steel		Stainless steel		Grey cast iron		Nodular cast iron		Malleable cast iron	
Material Description	1	2	3	4	5	6	7	8	9	10	11	12	13	14	15	16	17	18	19	20
VDI 3323	1	2	3	4	5	6	7	8	9	10	11	12	13	14	15	16	17	18	19	20
HRc	13	25	28	32	38	42	48	52	58	62	68	72	78	82	88	92	98	102	108	112
HB	125	190	250	270	300	180	275	300	350	200	325	200	240	180	180	260	160	250	130	230
Recommend	◎	◎	◎	◎	◎	◎	◎	◎	◎	◎	◎	◎	◎	◎	◎	◎	◎	◎	◎	◎



FLAT SHANK **E2464** SERIES

HSSCo8, 2 FLUTE 42° HELIX SHORT LENGTH for ALUMINUM

- HSSCo8, 2 SCHNEIDEN 42° RECHTSSPIRALE KURZ für ALUMINIUM
- Fraise HSSCo8, 2 dents, hélice 42°, pour aluminium, courte
- 2 TAGLIENTI, ELICA 42°, SERIE CORTA - HSSCo8

for ALUMINUM
für ALUMINIUM



Flat Shank	Page	Plain Shank	Page
END MILL HOLDER	D118-137	POWER MILLING CHUCK	D161-176
		ER COLLET CHUCK	D73-116
		SK SLIM CHUCK	D183-201

Unit : mm

EDP No.	Mill Diameter	Shank Diameter	Length of Cut	Overall Length
UNCOATED	e8	h6		
E2464010	1.0	6	3	49
E2464015	1.5	6	5	49
E2464020	2.0	6	7	51
E2464025	2.5	6	8	52
E2464030	3.0	6	8	52
E2464035	3.5	6	10	54
E2464040	4.0	6	11	55
E2464045	4.5	6	11	55
E2464050	5.0	6	13	57
E2464055	5.5	6	13	57
E2464060	6.0	6	13	57
E2464065	6.5	10	16	66
E2464070	7.0	10	16	66
E2464075	7.5	10	16	66
E2464080	8.0	10	19	69
E2464085	8.5	10	19	69
E2464090	9.0	10	19	69
E2464100	10.0	10	22	72
E2464110	11.0	12	22	79
E2464120	12.0	12	26	83
E2464130	13.0	12	26	83
E2464140	14.0	12	26	83
E2464150	15.0	12	26	83

- ▶ Other shank design on your request.
- ▶ TiN and TiCN Coatings are available on your request.

▶ NEXT PAGE

Tolerances according to DIN 7160 & 7161

	Tolerance range in μm					
	Nominal-Diameter in mm					
	from 1 to 3	over 3 to 6	over 6 to 10	over 10 to 18	over 18 to 30	over 30 to 50
e8	-14 -28	-20 -38	-25 -47	-32 -59	-40 -73	-50 -89
h6	0 -6	0 -8	0 -9	0 -11	0 -13	0 -16

◎ : Excellent ○ : Good

ISO	P										M				K					
	Non-alloy steel					Low alloy steel					High alloyed steel, and tool steel				Stainless steel		Grey cast iron	Nodular cast iron		Malleable cast iron
Material Description	1	2	3	4	5	6	7	8	9	10	11	12	13	14	15	16	17	18	19	20
VDI 3323	1	2	3	4	5	6	7	8	9	10	11	12	13	14	15	16	17	18	19	20
HRc	13	25	28	32	38	40	42	45	48	50	52	55	58	60	62	65	68	70	72	74
HB	125	190	250	270	300	180	275	300	350	200	325	200	240	180	180	260	160	250	130	230
Recommend	○	○	○	○	○	○	○	○	○	○	○	○	○	○	○	○	○	○	○	○



FLAT SHANK **E2464** SERIES

HSSCo8, 2 FLUTE 42° HELIX SHORT LENGTH for ALUMINUM

- HSSCo8, 2 SCHNEIDEN 42° RECHTSSPIRALE KURZ für ALUMINIUM
- Fraise HSSCo8, 2 dents, hélice 42°, pour aluminium, courte
- 2 TAGLIENTI, ELICA 42°, SERIE CORTA - HSSCo8

for ALUMINUM
für ALUMINIUM



Flat Shank	Page	Plain Shank	Page
END MILL HOLDER	D118-137	POWER MILLING CHUCK	D161-176
		ER COLLET CHUCK	D73-116
		SK SLIM CHUCK	D183-201

Unit : mm

EDP No.	Mill Diameter	Shank Diameter	Length of Cut	Overall Length
UNCOATED	e8	h6		
E2464160	16.0	16	32	92
E2464170	17.0	16	32	92
E2464180	18.0	16	32	92
E2464190	19.0	16	32	92
E2464200	20.0	20	38	104
E2464210	21.0	20	38	104
E2464220	22.0	20	38	104
E2464230	23.0	20	38	104
E2464240	24.0	25	45	121
E2464250	25.0	25	45	121
E2464260	26.0	25	45	121
E2464280	28.0	25	45	121
E2464300	30.0	25	45	121
E2464320	32.0	32	53	133

- ▶ Other shank design on your request.
- ▶ TiN and TiCN Coatings are available on your request.

Tolerances according to DIN 7160 & 7161

	Tolerance range in μm					
	Nominal-Diameter in mm					
	from 1 to 3	over 3 to 6	over 6 to 10	over 10 to 18	over 18 to 30	over 30 to 50
e8	-14 -28	-20 -38	-25 -47	-32 -59	-40 -73	-50 -89
h6	0 -6	0 -8	0 -9	0 -11	0 -13	0 -16

◎ : Excellent ○ : Good

ISO	P										M				K					
	Non-alloy steel					Low alloy steel					High alloyed steel, and tool steel				Stainless steel		Grey cast iron	Nodular cast iron		Malleable cast iron
Material Description	1	2	3	4	5	6	7	8	9	10	11	12	13	14	15	16	17	18	19	20
VDI 3323	1	2	3	4	5	6	7	8	9	10	11	12	13	14	15	16	17	18	19	20
HRc	13	25	28	32	38	40	42	45	48	50	52	55	58	60	62	65	68	70	72	74
HB	125	190	250	270	300	180	275	300	350	200	325	200	240	180	180	260	160	250	130	230
Recommend	○	○	○	○	○	○	○	○	○	○	○	○	○	○	○	○	○	○	○	○



FLAT SHANK **E2509** SERIES

HSSCo8, 2 FLUTE 42° HELIX LONG LENGTH for ALUMINUM
 ● HSSCo8, 2 SCHNEIDEN 42° RECHTSSPIRALE KURZ für ALUMINIUM
 ○ Fraise HSSCo8, 2 dents, hélice 42°, pour aluminium, longue
 ○ 2 TAGLIENTI, ELICA 42°, SERIE LUNGA - HSSCo8

for ALUMINIUM
für ALUMINIUM



HSS Co8 DIN 844 2 42° DIN 1835B UNCOATED p.C675

Flat Shank	Page	Plain Shank	Page
END MILL HOLDER	D118-137	POWER MILLING CHUCK	D161-176
		ER COLLET CHUCK	D73-116
		SK SLIM CHUCK	D183-201

Unit : mm

EDP No.	Mill Diameter	Shank Diameter	Length of Cut	Overall Length
UNCOATED	e8	h6		
E2509020	2.0	6	10	54
E2509030	3.0	6	12	56
E2509040	4.0	6	19	63
E2509050	5.0	6	24	68
E2509060	6.0	6	24	68
E2509070	7.0	10	30	80
E2509080	8.0	10	38	88
E2509090	9.0	10	38	88
E2509100	10.0	10	45	95
E2509110	11.0	12	45	102
E2509120	12.0	12	53	110
E2509130	13.0	12	53	110
E2509140	14.0	12	53	110
E2509150	15.0	12	53	110
E2509160	16.0	16	63	123
E2509180	18.0	16	63	123
E2509200	20.0	20	75	141

▶ Other shank design on your request.
 ▶ TiN and TiCN Coatings are available on your request.

Tolerances according to DIN 7160 & 7161

Tolerance range in μm						
Nominal-Diameter in mm						
	from 1 to 3	over 3 to 6	over 6 to 10	over 10 to 18	over 18 to 30	over 30 to 50
e8	-14 -28	-20 -38	-25 -47	-32 -59	-40 -73	-50 -89
h6	0 -6	0 -8	0 -9	0 -11	0 -13	0 -16

◎ : Excellent ○ : Good

ISO	P									M				K							
Material Description	Non-alloy steel			Low alloy steel			High alloyed steel, and tool steel			Stainless steel				Grey cast iron		Nodular cast iron		Malleable cast iron			
VDI 3323	1	2	3	4	5	6	7	8	9	10	11	12	13	14	15	16	17	18	19	20	
HRc	13	25	28	32	30	10	29	32	38	15	35	15	23	10	10	26	3	25	21	21	
HB	125	190	250	270	300	180	275	300	350	200	325	200	240	180	180	260	160	250	130	230	
Recommend	○	○			○																

ISO	N					S					H											
Material Description	Aluminum-wrought alloy		Aluminum-cast, alloyed			Copper and Copper Alloys (Bronze / Brass)			Non Metallic Materials		Heat Resistant Super Alloys					Titanium Alloys		Hardened steel	Chilled Cast Iron	Hardened Cast Iron		
VDI 3323	21	22	23	24	25	26	27	28	29	30	31	32	33	34	35	36	37	38	39	40	41	
HRc											15	30	25	38	34			55	60	42	55	
HB	60	100	75	90	130	110	90	100			200	280	250	350	320	400 Rm	1050 Rm	550	630	400	550	
Recommend	◎	◎	◎	◎	○																	



FLAT SHANK **E2572** SERIES
 FLAT SHANK **EQ572** SERIES

HSSCo8, 3 FLUTE STUB LENGTH
 ● HSSCo8, 3 SCHNEIDEN EXTRA KURZ
 ○ Fraise HSSCo8, 3 dents, extra-courte
 ○ 3 TAGLIENTI. SERIE EXTRA CORTA - HSSCo8



HSS Co8 DIN 327 3 30° DIN 1835B UNCOATED TiAlN p.C680-687

Flat Shank	Page	Plain Shank	Page
END MILL HOLDER	D118-137	POWER MILLING CHUCK	D161-176
		ER COLLET CHUCK	D73-116
		SK SLIM CHUCK	D183-201

Unit : mm

EDP No.	Mill Diameter	Shank Diameter	Length of Cut	Overall Length	
UNCOATED	e8	h6			
E2572015	EQ572015	1.5	6	3	47
E2572020	EQ572020	2.0	6	4	48
E2572025	EQ572025	2.5	6	5	49
E2572030	EQ572030	3.0	6	5	49
E2572035	EQ572035	3.5	6	6	50
E2572040	EQ572040	4.0	6	7	51
E2572045	EQ572045	4.5	6	7	51
E2572050	EQ572050	5.0	6	8	52
E2572055	EQ572055	5.5	6	8	52
E2572060	EQ572060	6.0	6	8	52
E2572065	EQ572065	6.5	10	10	60
E2572070	EQ572070	7.0	10	10	60
E2572075	EQ572075	7.5	10	10	60
E2572080	EQ572080	8.0	10	11	61
E2572085	EQ572085	8.5	10	11	61
E2572100	EQ572100	10.0	10	13	63
E2572120	EQ572120	12.0	12	16	73
E2572140	EQ572140	14.0	12	16	73
E2572150	EQ572150	15.0	12	16	73
E2572160	EQ572160	16.0	16	19	79
E2572180	EQ572180	18.0	16	19	79
E2572200	EQ572200	20.0	20	22	88
E2572220	EQ572220	22.0	20	22	88
E2572240	EQ572240	24.0	25	26	102
E2572250	EQ572250	25.0	25	26	102
E2572260	EQ572260	26.0	25	26	102
E2572280	EQ572280	28.0	25	26	102
E2572300	EQ572300	30.0	25	26	102
E2572320	EQ572320	32.0	32	32	112

▶ Other shank design on your request.
 ▶ TiN and TiCN Coatings are available on your request.

Tolerances according to DIN 7160 & 7161

Tolerance range in μm						
Nominal-Diameter in mm						
	from 1 to 3	over 3 to 6	over 6 to 10	over 10 to 18	over 18 to 30	over 30 to 50
e8	-14 -28	-20 -38	-25 -47	-32 -59	-40 -73	-50 -89
h6	0 -6	0 -8	0 -9	0 -11	0 -13	0 -16

◎ : Excellent ○ : Good

ISO	P									M				K							
Material Description	Non-alloy steel			Low alloy steel			High alloyed steel, and tool steel			Stainless steel				Grey cast iron		Nodular cast iron		Malleable cast iron			
VDI 3323	1	2	3	4	5	6	7	8	9	10	11	12	13	14	15	16	17	18	19	20	
HRc	13	25	28	32	30	10	29	32	38	15	35	15	23	10	10	26	3	25	21	21	
HB	125	190	250	270	300	180	275	300	350	200	325	200	240	180	180	260	160	250	130	230	
Recommend	◎	◎	◎	◎	◎	◎	◎	◎	◎	○	◎										

ISO	N					S					H											
Material Description	Aluminum-wrought alloy		Aluminum-cast, alloyed			Copper and Copper Alloys (Bronze / Brass)			Non Metallic Materials		Heat Resistant Super Alloys					Titanium Alloys		Hardened steel	Chilled Cast Iron	Hardened Cast Iron		
VDI 3323	21	22	23	24	25	26	27	28	29	30	31	32	33	34	35	36	37	38	39	40	41	
HRc											15	30	25	38	34			55	60	42	55	
HB	60	100	75	90	130	110	90	100			200	280	250	350	320	400 Rm	1050 Rm	550	630	400	550	
Recommend	◎	◎	◎	◎	○																	



FLAT SHANK **E2573** SERIES
FLAT SHANK **EQ573** SERIES

HSSCo8, 3 FLUTE SHORT LENGTH

● **HSSCo8, 3 SCHNEIDEN KURZ**
● **Fraise HSSCo8, 3 dents, courte**
● **3 TAGLIENTI, SERIE CORTA - HSSCo8**

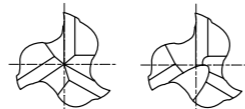

Under \varnothing 3mm \varnothing 3mm or above



Flat Shank	Page	Plain Shank	Page
END MILL HOLDER D118-137		POWER MILLING CHUCK D161-176	
		ER COLLET CHUCK D73-116	
		SK SLIM CHUCK D183-201	

Unit : mm

EDP No.	Mill Diameter		Shank Diameter	Length of Cut	Overall Length	
	UNCOATED	TiAlN				
E2573010	EQ573010	1.0	e8	h6	3	47
E2573015	EQ573015	1.5			7	51
E2573020	EQ573020	2.0			7	51
E2573025	EQ573025	2.5			8	52
E2573030	EQ573030	3.0			8	52
E2573035	EQ573035	3.5			10	54
E2573040	EQ573040	4.0			11	55
E2573045	EQ573045	4.5			11	55
E2573050	EQ573050	5.0			13	57
E2573055	EQ573055	5.5			13	57
E2573060	EQ573060	6.0			13	57
E2573065	EQ573065	6.5			16	66
E2573070	EQ573070	7.0			16	66
E2573075	EQ573075	7.5			16	66
E2573080	EQ573080	8.0			19	69
E2573085	EQ573085	8.5			19	69
E2573090	EQ573090	9.0			19	69
E2573095	EQ573095	9.5			19	69
E2573100	EQ573100	10.0			22	72
E2573120	EQ573120	12.0			26	83
E2573140	EQ573140	14.0			26	83
E2573150	EQ573150	15.0			26	83
E2573160	EQ573160	16.0			32	92
E2573180	EQ573180	18.0			32	92

Tolerances according to DIN 7160 & 7161

▶ Other shank design on your request. ▶ NEXT PAGE
▶ TiN and TiCN Coatings are available on your request.

	Tolerance range in μ m					
	Nominal-Diameter in mm					
	from 1 to 3	over 3 to 6	over 6 to 10	over 10 to 18	over 18 to 30	over 30 to 50
e8	-14 -28	-20 -38	-25 -47	-32 -59	-40 -73	-50 -89
h6	0 -6	0 -8	0 -9	0 -11	0 -13	0 -16

◎ : Excellent ○ : Good

ISO	P										M				K						
	Non-alloy steel					Low alloy steel					High alloyed steel, and tool steel		Stainless steel		Grey cast iron		Nodular cast iron		Malleable cast iron		
Material Description	1	2	3	4	5	6	7	8	9	10	11	12	13	14	15	16	17	18	19	20	
VDI 3323																					
HRc	13	25	28	32	30	10	29	32	38	15	35	15	23	10	10	26	3	25	21	21	
HB	125	190	250	270	300	180	275	300	350	200	325	200	240	180	180	260	160	250	130	230	
Recommend	◎	◎	◎	◎	◎	◎	◎	◎	◎	◎	◎	◎	◎	◎	◎	◎	◎	◎	◎	◎	◎

ISO	N										S				H							
	Aluminum-wrought alloy		Aluminum-cast, alloyed			Copper and Copper Alloys (Bronze / Brass)			Non Metallic Materials		Heat Resistant Super Alloys				Titanium Alloys		Hardened steel		Chilled Cast Iron		Hardened Cast Iron	
Material Description	21	22	23	24	25	26	27	28	29	30	31	32	33	34	35	36	37	38	39	40	41	
VDI 3323																						
HRc	21	22	23	24	25	26	27	28	29	30	31	32	33	34	35	36	37	38	39	40	41	
HB	60	100	75	90	130	110	90	100			200	280	250	350	320	400 Rm	1050 Rm	550	630	400	550	
Recommend	◎	◎	◎	◎	◎	◎	◎	◎	◎	◎	◎	◎	◎	◎	◎	◎	◎	◎	◎	◎	◎	◎



FLAT SHANK **E2573** SERIES
FLAT SHANK **EQ573** SERIES

HSSCo8, 3 FLUTE SHORT LENGTH

● **HSSCo8, 3 SCHNEIDEN KURZ**
● **Fraise HSSCo8, 3 dents, courte**
● **3 TAGLIENTI, SERIE CORTA - HSSCo8**

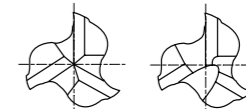

Under \varnothing 3mm \varnothing 3mm or above



Flat Shank	Page	Plain Shank	Page
END MILL HOLDER D118-137		POWER MILLING CHUCK D161-176	
		ER COLLET CHUCK D73-116	
		SK SLIM CHUCK D183-201	

Unit : mm

EDP No.	Mill Diameter		Shank Diameter	Length of Cut	Overall Length	
	UNCOATED	TiAlN				
E2573200	EQ573200	20.0	e8	h6	38	104
E2573220	EQ573220	22.0			38	104
E2573240	EQ573240	24.0			45	121
E2573250	EQ573250	25.0			45	121
E2573260	EQ573260	26.0			45	121
E2573280	EQ573280	28.0			45	121
E2573300	EQ573300	30.0			45	121
E2573320	EQ573320	32.0			53	133
E2573400	EQ573400	40.0			63	155

▶ Other shank design on your request.
▶ TiN and TiCN Coatings are available on your request.

Tolerances according to DIN 7160 & 7161

	Tolerance range in μ m					
	Nominal-Diameter in mm					
	from 1 to 3	over 3 to 6	over 6 to 10	over 10 to 18	over 18 to 30	over 30 to 50
e8	-14 -28	-20 -38	-25 -47	-32 -59	-40 -73	-50 -89
h6	0 -6	0 -8	0 -9	0 -11	0 -13	0 -16

◎ : Excellent ○ : Good

ISO	P										M				K						
	Non-alloy steel					Low alloy steel					High alloyed steel, and tool steel		Stainless steel		Grey cast iron		Nodular cast iron		Malleable cast iron		
Material Description	1	2	3	4	5	6	7	8	9	10	11	12	13	14	15	16	17	18	19	20	
VDI 3323																					
HRc	13	25	28	32	30	10	29	32	38	15	35	15	23	10	10	26	3	25	21	21	
HB	125	190	250	270	300	180	275	300	350	200	325	200	240	180	180	260	160	250	130	230	
Recommend	◎	◎	◎	◎	◎	◎	◎	◎	◎	◎	◎	◎	◎	◎	◎	◎	◎	◎	◎	◎	◎

ISO	N										S				H							
	Aluminum-wrought alloy		Aluminum-cast, alloyed			Copper and Copper Alloys (Bronze / Brass)			Non Metallic Materials		Heat Resistant Super Alloys				Titanium Alloys		Hardened steel		Chilled Cast Iron		Hardened Cast Iron	
Material Description	21	22	23	24	25	26	27	28	29	30	31	32	33	34	35	36	37	38	39	40	41	
VDI 3323																						
HRc	21	22	23	24	25	26	27	28	29	30	31	32	33	34	35	36	37	38	39	40	41	
HB	60	100	75	90	130	110	90	100			200	280	250	350	320	400 Rm	1050 Rm	550	630	400	550	
Recommend	◎	◎	◎	◎	◎	◎	◎	◎	◎	◎	◎	◎	◎	◎	◎	◎	◎	◎	◎	◎	◎	◎



FLAT SHANK **E2516** SERIES
FLAT SHANK **EQ516** SERIES

HSSCo8, 3 FLUTE LONG LENGTH

HSSCo8, 3 SCHNEIDEN LANG
Fraise HSSCo8, 3 dents, longue
3 TAGLIENTI, SERIE LUNGA - HSSCo8

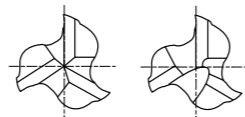

Up to Ø2.5mm Over Ø2.5mm



Flat Shank	Page	Plain Shank	Page
END MILL HOLDER	D118-137	POWER MILLING CHUCK	D161-176
		ER COLLET CHUCK	D73-116
		SK SLIM CHUCK	D183-201

Unit : mm

EDP No.	Mill Diameter		Shank Diameter		Length of Cut	Overall Length
	UNCOATED	TiAlN	e8	h6		
E2516020	EQ516020	2.0	6	10	54	
E2516025	EQ516025	2.5	6	12	56	
E2516030	EQ516030	3.0	6	12	56	
E2516035	EQ516035	3.5	6	15	59	
E2516040	EQ516040	4.0	6	19	63	
E2516045	EQ516045	4.5	6	19	63	
E2516050	EQ516050	5.0	6	24	68	
E2516055	EQ516055	5.5	6	24	68	
E2516060	EQ516060	6.0	6	24	68	
E2516070	EQ516070	7.0	10	30	80	
E2516075	EQ516075	7.5	10	30	80	
E2516080	EQ516080	8.0	10	38	88	
E2516090	EQ516090	9.0	10	38	88	
E2516100	EQ516100	10.0	10	45	95	
E2516110	EQ516110	11.0	12	45	102	
E2516120	EQ516120	12.0	12	53	110	
E2516130	EQ516130	13.0	12	53	110	
E2516140	EQ516140	14.0	12	53	110	
E2516150	EQ516150	15.0	12	53	110	
E2516160	EQ516160	16.0	16	63	123	
E2516170	EQ516170	17.0	16	63	123	
E2516180	EQ516180	18.0	16	63	123	
E2516190	EQ516190	19.0	16	63	123	
E2516901	EQ516901	20.0	16	75	135	

Tolerances according to DIN 7160 & 7161

► Other shank design on your request. ► NEXT PAGE
► TiN and TiCN Coatings are available on your request.

	Tolerance range in μ m					
	Nominal-Diameter in mm					
	from 1 to 3	over 3 to 6	over 6 to 10	over 10 to 18	over 18 to 30	over 30 to 50
e8	-14 -28	-20 -38	-25 -47	-32 -59	-40 -73	-50 -89
h6	0 -6	0 -8	0 -9	0 -11	0 -13	0 -16

◎ : Excellent ○ : Good

ISO	P										M				K					
	Non-alloy steel					Low alloy steel					High alloyed steel, and tool steel		Stainless steel		Grey cast iron	Nodular cast iron	Malleable cast iron			
Material Description	1	2	3	4	5	6	7	8	9	10	11	12	13	14	15	16	17	18	19	20
VDI 3323	1	2	3	4	5	6	7	8	9	10	11	12	13	14	15	16	17	18	19	20
HRc	13	25	28	32	35	38	40	42	45	48	50	52	54	56	58	60	62	64	66	68
HB	125	190	250	270	300	180	275	300	350	200	325	200	240	180	180	260	160	250	130	230
Recommend	◎	◎	◎	◎	◎	◎	◎	◎	◎	◎	◎	◎	◎	◎	◎	◎	◎	◎	◎	◎



FLAT SHANK **E2516** SERIES
FLAT SHANK **EQ516** SERIES

HSSCo8, 3 FLUTE LONG LENGTH

HSSCo8, 3 SCHNEIDEN LANG
Fraise HSSCo8, 3 dents, longue
3 TAGLIENTI, SERIE LUNGA - HSSCo8

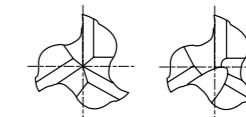

Up to Ø2.5mm Over Ø2.5mm



Flat Shank	Page	Plain Shank	Page
END MILL HOLDER	D118-137	POWER MILLING CHUCK	D161-176
		ER COLLET CHUCK	D73-116
		SK SLIM CHUCK	D183-201

Unit : mm

EDP No.	Mill Diameter		Shank Diameter		Length of Cut	Overall Length
	UNCOATED	TiAlN	e8	h6		
E2516200	EQ516200	20.0	20	75	141	
E2516220	EQ516220	22.0	20	75	141	
E2516240	EQ516240	24.0	25	90	166	
E2516250	EQ516250	25.0	25	90	166	
E2516260	EQ516260	26.0	25	90	166	
E2516280	EQ516280	28.0	25	90	166	
E2516300	EQ516300	30.0	25	90	166	
E2516320	EQ516320	32.0	32	106	186	
E2516350	EQ516350	35.0	32	106	186	
E2516360	EQ516360	36.0	32	106	186	
E2516400	EQ516400	40.0	40	125	217	

► Other shank design on your request.
► TiN and TiCN Coatings are available on your request.

Tolerances according to DIN 7160 & 7161

	Tolerance range in μ m					
	Nominal-Diameter in mm					
	from 1 to 3	over 3 to 6	over 6 to 10	over 10 to 18	over 18 to 30	over 30 to 50
e8	-14 -28	-20 -38	-25 -47	-32 -59	-40 -73	-50 -89
h6	0 -6	0 -8	0 -9	0 -11	0 -13	0 -16

◎ : Excellent ○ : Good

ISO	P										M				K					
	Non-alloy steel					Low alloy steel					High alloyed steel, and tool steel		Stainless steel		Grey cast iron	Nodular cast iron	Malleable cast iron			
Material Description	1	2	3	4	5	6	7	8	9	10	11	12	13	14	15	16	17	18	19	20
VDI 3323	1	2	3	4	5	6	7	8	9	10	11	12	13	14	15	16	17	18	19	20
HRc	13	25	28	32	35	38	40	42	45	48	50	52	54	56	58	60	62	64	66	68
HB	125	190	250	270	300	180	275	300	350	200	325	200	240	180	180	260	160	250	130	230
Recommend	◎	◎	◎	◎	◎	◎	◎	◎	◎	◎	◎	◎	◎	◎	◎	◎	◎	◎	◎	◎



FLAT SHANK **E2553** SERIES
FLAT SHANK **EQ553** SERIES

HSSCo8, 3 FLUTE SHORT LENGTH THROW AWAY

● **HSSCo8, 3 SCHNEIDEN KURZ EINWEGFRÄSER**
 () **Fraise HSSCo8, 3 dents à jeter, courte**
 () **3 TAGLIENTI, SERIE CORTA NON RIAFFILABILE - HSSCo8**

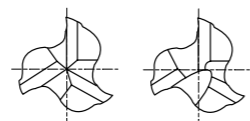

Up to Ø10mm Over Ø10mm



p.C680-687

Flat Shank	Page	Plain Shank	Page
END MILL HOLDER	D118-137	POWER MILLING CHUCK	D161-176
ER COLLET CHUCK	D73-116	SK SLIM CHUCK	D183-201



Unit : mm

EDP No.	Mill Diameter	Shank Diameter	Length of Cut	Overall Length	
					UNCOATED
E2553010	EQ553010	1.0	6	2	34
E2553013	EQ553013	1.3	6	3	34
E2553015	EQ553015	1.5	6	3	34
E2553018	EQ553018	1.8	6	3	34
E2553020	EQ553020	2.0	6	4	35
E2553023	EQ553023	2.3	6	4	35
E2553025	EQ553025	2.5	6	5	36
E2553028	EQ553028	2.8	6	5	36
E2553030	EQ553030	3.0	6	5	36
E2553033	EQ553033	3.3	6	6	37
E2553035	EQ553035	3.5	6	6	37
E2553038	EQ553038	3.8	6	7	38
E2553040	EQ553040	4.0	6	7	38
E2553043	EQ553043	4.3	6	7	38
E2553045	EQ553045	4.5	6	7	38
E2553048	EQ553048	4.8	6	8	39
E2553050	EQ553050	5.0	6	8	39
E2553053	EQ553053	5.3	6	8	39
E2553055	EQ553055	5.5	6	8	39
E2553957	EQ553957	5.8	6	8	39
E2553060	EQ553060	6.0	6	8	39
E2553065	EQ553065	6.5	8	10	42
E2553070	EQ553070	7.0	8	10	42
E2553075	EQ553075	7.5	8	10	42

► TiN and TiCN Coatings are available on your request.

► NEXT PAGE

Tolerances according to DIN 7160 & 7161

	Tolerance range in μm					
	Nominal-Diameter in mm					
	from 1 to 3	over 3 to 6	over 6 to 10	over 10 to 18	over 18 to 30	over 30 to 50
e8	-14	-20	-25	-32	-40	-50
	-28	-38	-47	-59	-73	-89
h6	0	0	0	0	0	0
	-6	-8	-9	-11	-13	-16

◎ : Excellent ○ : Good

ISO	P										M				K					
	Non-alloy steel					Low alloy steel					High alloyed steel, and tool steel				Stainless steel		Grey cast iron	Nodular cast iron		Malleable cast iron
Material Description	1	2	3	4	5	6	7	8	9	10	11	12	13	14	15	16	17	18	19	20
VDI 3323	1	2	3	4	5	6	7	8	9	10	11	12	13	14	15	16	17	18	19	20
HRc	13	25	28	32	38	40	42	45	48	50	52	55	58	60	62	65	68	70	72	75
HB	125	190	250	270	300	180	275	300	350	200	325	200	240	180	180	260	160	250	130	230
Recommend	◎	◎	◎	◎	◎	◎	◎	◎	◎	◎	◎	◎	◎	◎	◎	◎	◎	◎	◎	◎



FLAT SHANK **E2553** SERIES
FLAT SHANK **EQ553** SERIES

HSSCo8, 3 FLUTE SHORT LENGTH THROW AWAY

● **HSSCo8, 3 SCHNEIDEN KURZ EINWEGFRÄSER**
 () **Fraise HSSCo8, 3 dents à jeter, courte**
 () **3 TAGLIENTI, SERIE CORTA NON RIAFFILABILE - HSSCo8**

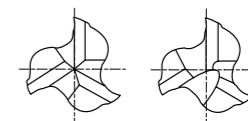

Up to Ø10mm Over Ø10mm



p.C680-687

Flat Shank	Page	Plain Shank	Page
END MILL HOLDER	D118-137	POWER MILLING CHUCK	D161-176
ER COLLET CHUCK	D73-116	SK SLIM CHUCK	D183-201



Unit : mm

EDP No.	Mill Diameter	Shank Diameter	Length of Cut	Overall Length	
					UNCOATED
E2553080	EQ553080	8.0	8	11	43
E2553085	EQ553085	8.5	10	11	48
E2553090	EQ553090	9.0	10	11	48
E2553095	EQ553095	9.5	10	11	48
E2553100	EQ553100	10.0	10	13	50
E2553120	EQ553120	12.0	12	16	58
E2553160	EQ553160	16.0	16	19	64
E2553200	EQ553200	20.0	20	22	78

► TiN and TiCN Coatings are available on your request.

Tolerances according to DIN 7160 & 7161

	Tolerance range in μm					
	Nominal-Diameter in mm					
	from 1 to 3	over 3 to 6	over 6 to 10	over 10 to 18	over 18 to 30	over 30 to 50
e8	-14	-20	-25	-32	-40	-50
	-28	-38	-47	-59	-73	-89
h6	0	0	0	0	0	0
	-6	-8	-9	-11	-13	-16

SET ORDERING No.:
E2SET553
 * 12PCS. SET
 SHORT LENGTH
 - 2PCS. OF EACH SIZE
 2, 3, 4, 5, 6mm (C3FSC)
 - 1PC. OF EACH SIZE
 8, 10mm (C3FSC)

◎ : Excellent ○ : Good

ISO	P										M				K					
	Non-alloy steel					Low alloy steel					High alloyed steel, and tool steel				Stainless steel		Grey cast iron	Nodular cast iron		Malleable cast iron
Material Description	1	2	3	4	5	6	7	8	9	10	11	12	13	14	15	16	17	18	19	20
VDI 3323	1	2	3	4	5	6	7	8	9	10	11	12	13	14	15	16	17	18	19	20
HRc	13	25	28	32	38	40	42	45	48	50	52	55	58	60	62	65	68	70	72	75
HB	125	190	250	270	300	180	275	300	350	200	325	200	240	180	180	260	160	250	130	230
Recommend	◎	◎	◎	◎	◎	◎	◎	◎	◎	◎	◎	◎	◎	◎	◎	◎	◎	◎	◎	◎



FLAT SHANK **E2554** SERIES
FLAT SHANK **EQ554** SERIES

HSSCo8, 3 FLUTE LONG LENGTH THROW AWAY

- HSSCo8, 3 SCHNEIDEN LANG EINWEGFRÄSER
- Fraise HSSCo8, 3 dents à jeter, longue
- 3 TAGLIENTI, SERIE LUNGA, NON RIAFFILABILE - HSSCo8



p.C680-687

Flat Shank	Page	Plain Shank	Page
END MILL HOLDER	D118-137	POWER MILLING CHUCK	D161-176
		ER COLLET CHUCK	D73-116
		SK SLIM CHUCK	D183-201



Unit : mm

EDP No.	Mill Diameter		Shank Diameter	Length of Cut	Overall Length
	UNCOATED	TiAlN			
	e8	h6			
E2554015	EQ554015	1.5	6	4	35
E2554020	EQ554020	2.0	6	7	38
E2554025	EQ554025	2.5	6	8	39
E2554030	EQ554030	3.0	6	8	39
E2554035	EQ554035	3.5	6	10	41
E2554040	EQ554040	4.0	6	11	42
E2554045	EQ554045	4.5	6	11	42
E2554050	EQ554050	5.0	6	13	44
E2554055	EQ554055	5.5	6	13	44
E2554060	EQ554060	6.0	6	13	44
E2554065	EQ554065	6.5	8	16	48
E2554070	EQ554070	7.0	8	16	48
E2554075	EQ554075	7.5	8	16	48
E2554080	EQ554080	8.0	8	19	51
E2554085	EQ554085	8.5	10	19	56
E2554090	EQ554090	9.0	10	19	56
E2554095	EQ554095	9.5	10	19	56
E2554100	EQ554100	10.0	10	22	59

► TiN and TiCN Coatings are available on your request.

Tolerances according to DIN 7160 & 7161

	Tolerance range in μ m					
	Nominal-Diameter in mm					
	from 1 to 3	over 3 to 6	over 6 to 10	over 10 to 18	over 18 to 30	over 30 to 50
e8	-14 -28	-20 -38	-25 -47	-32 -59	-40 -73	-50 -89
h6	0 -6	0 -8	0 -9	0 -11	0 -13	0 -16

◎ : Excellent ○ : Good

ISO	P										M				K					
	Non-alloy steel					Low alloy steel					High alloyed steel, and tool steel				Stainless steel		Grey cast iron	Nodular cast iron		Malleable cast iron
Material Description	1	2	3	4	5	6	7	8	9	10	11	12	13	14	15	16	17	18	19	20
VDI 3323	1	2	3	4	5	6	7	8	9	10	11	12	13	14	15	16	17	18	19	20
HRc	13	25	28	32	38	40	42	45	48	50	52	55	58	60	62	65	68	70	72	75
HB	125	190	250	270	300	180	275	300	350	200	325	200	240	180	180	260	160	250	130	230
Recommend	◎	◎	◎	◎	◎	◎	◎	◎	◎	◎	◎	◎	◎	◎	◎	◎	◎	◎	◎	◎



FLAT SHANK **E2574** SERIES
FLAT SHANK **EQ574** SERIES

HSSCo8, 4 FLUTE SHORT LENGTH

- HSSCo8, 4&6 SCHNEIDEN KURZ
- Fraise HSSCo8, 4&6 dents, courte
- HSSCo8, 4&6 TAGLIENTI, SERIE CORTA



p.C688-691

Flat Shank	Page	Plain Shank	Page
END MILL HOLDER	D118-137	POWER MILLING CHUCK	D161-176
		ER COLLET CHUCK	D73-116
		SK SLIM CHUCK	D183-201



Unit : mm

EDP No.	Mill Diameter		Shank Diameter	Length of Cut	Overall Length	No. of Flute
	UNCOATED	TiAlN				
	e8	h6				
E2574020	EQ574020	2.0	6	7	51	4
E2574025	EQ574025	2.5	6	8	52	4
E2574030	EQ574030	3.0	6	8	52	4
E2574035	EQ574035	3.5	6	10	54	4
E2574040	EQ574040	4.0	6	11	55	4
E2574050	EQ574050	5.0	6	13	57	4
E2574060	EQ574060	6.0	6	13	57	4
E2574070	EQ574070	7.0	10	16	66	4
E2574080	EQ574080	8.0	10	19	69	4
E2574090	EQ574090	9.0	10	19	69	4
E2574100	EQ574100	10.0	10	22	72	4
E2574110	EQ574110	11.0	12	22	79	4
E2574120	EQ574120	12.0	12	26	83	4
E2574130	EQ574130	13.0	12	26	83	4
E2574140	EQ574140	14.0	12	26	83	4
E2574150	EQ574150	15.0	12	26	83	4
E2574160	EQ574160	16.0	16	32	92	4
E2574170	EQ574170	17.0	16	32	92	4
E2574180	EQ574180	18.0	16	32	92	4
E2574190	EQ574190	19.0	16	32	92	4
E2574200	EQ574200	20.0	20	38	104	4

► Other shank design on your request.
► TiN and TiCN Coatings are available on your request.

Mill Dia. Tolerance (mm)	Shank Dia. Tolerance
0 ~ + 0.04	h6

◎ : Excellent ○ : Good

ISO	P										M				K					
	Non-alloy steel					Low alloy steel					High alloyed steel, and tool steel				Stainless steel		Grey cast iron	Nodular cast iron		Malleable cast iron
Material Description	1	2	3	4	5	6	7	8	9	10	11	12	13	14	15	16	17	18	19	20
VDI 3323	1	2	3	4	5	6	7	8	9	10	11	12	13	14	15	16	17	18	19	20
HRc	13	25	28	32	38	40	42	45	48	50	52	55	58	60	62	65	68	70	72	75
HB	125	190	250	270	300	180	275	300	350	200	325	200	240	180	180	260	160	250	130	230
Recommend	◎	◎	◎	◎	◎	◎	◎	◎	◎	◎	◎	◎	◎	◎	◎	◎	◎	◎	◎	◎



FLAT SHANK **E2595** SERIES
 FLAT SHANK **EQ595** SERIES

HSSCo8, 4 FLUTE SHORT LENGTH - CENTER CUTTING

- HSSCo8, 4&6 SCHNEIDEN KURZ
- Ⓢ Fraise HSSCo8, 4&6 dents, coupe au centre, courte
- Ⓢ 4 - 6 TAGLIENTI, SERIE CORTA, TAGLIENTE AL CENTRO - HSSCo8



HSS Co8 DIN 844 4 30° UNCOATED TiAlN p.C696-699

Flat Shank	Page	Plain Shank	Page
END MILL HOLDER	D118-137	POWER MILLING CHUCK	D161-176
		ER COLLET CHUCK	D73-116
		SK SLIM CHUCK	D183-201

Unit : mm

EDP No.	Mill Diameter	Shank Diameter	Length of Cut	Overall Length
E2595020	2.0	6	7	51
E2595030	3.0	6	8	52
E2595040	4.0	6	11	55
E2595050	5.0	6	13	57
E2595060	6.0	6	13	57
E2595070	7.0	10	16	66
E2595080	8.0	10	19	69
E2595090	9.0	10	19	69
E2595100	10.0	10	22	72
E2595110	11.0	12	22	79
E2595120	12.0	12	26	83
E2595130	13.0	12	26	83
E2595140	14.0	12	26	83
E2595150	15.0	12	26	83
E2595160	16.0	16	32	92
E2595170	17.0	16	32	92
E2595180	18.0	16	32	92
E2595190	19.0	16	32	92
E2595920	20.0	16	38	98
E2595200	20.0	20	38	104
E2595220	22.0	20	38	104
E2595250	25.0	25	45	121

- ▶ Other shank design on your request.
- ▶ TiN and TiCN Coatings are available on your request.

Mill Dia. Tolerance (mm)	Shank Dia. Tolerance
0 ~ + 0.04	h6

◎ : Excellent ○ : Good

ISO Material Description	P										M				K						
	Non-alloy steel					Low alloy steel					High alloyed steel, and tool steel		Stainless steel		Grey cast iron	Nodular cast iron	Malleable cast iron				
VDI 3323	1	2	3	4	5	6	7	8	9	10	11	12	13	14	15	16	17	18	19	20	
HRc	13	25	28	32	30	10	29	32	38	15	35	15	23	10	10	26	3	25	21	21	
HB	125	190	250	270	300	180	275	300	350	200	325	200	240	180	180	260	160	250	130	230	
Recommend	◎	◎	◎	◎	◎	◎	◎	◎	◎	◎	◎	◎	◎	◎	◎	◎	◎	◎	◎	◎	◎

ISO Material Description	N										S					H						
	Aluminum-wrought alloy		Aluminum-cast, alloyed			Copper and Copper Alloys (Bronze / Brass)			Non Metallic Materials		Heat Resistant Super Alloys					Titanium Alloys		Hardened steel	Chilled Cast Iron	Hardened Cast Iron		
VDI 3323	21	22	23	24	25	26	27	28	29	30	31	32	33	34	35	36	37	38	39	40	41	
HRc	21	22	23	24	25	26	27	28	29	30	31	32	33	34	35	36	37	38	39	40	41	
HB	60	100	75	90	130	110	90	100			200	280	250	350	320	400 Rm	1050 Rm	550	630	400	550	
Recommend	○	○	○	○	○	○	○	○	○	○	○	○	○	○	○	○	○	○	○	○	○	○



FLAT SHANK **E2597** SERIES
 FLAT SHANK **EQ597** SERIES

HSSCo8, 4 FLUTE LONG LENGTH - CENTER CUTTING

- HSSCo8, 4&6 SCHNEIDEN LANG
- Ⓢ Fraise HSSCo8, 4&6 dents, coupe au centre, longue
- Ⓢ 4&6 TAGLIENTI, SERIE LUNGA, TAGLIENTE AL CENTRO - HSSCo8



HSS Co8 DIN 844 4 30° UNCOATED TiAlN p.C688-691

Flat Shank	Page	Plain Shank	Page
END MILL HOLDER	D118-137	POWER MILLING CHUCK	D161-176
		ER COLLET CHUCK	D73-116
		SK SLIM CHUCK	D183-201

Unit : mm

EDP No.	Mill Diameter	Shank Diameter	Length of Cut	Overall Length
E2597020	2.0	6	10	54
E2597025	2.5	6	12	56
E2597030	3.0	6	12	56
E2597035	3.5	6	15	59
E2597040	4.0	6	19	63
E2597045	4.5	6	19	63
E2597050	5.0	6	24	68
E2597055	5.5	6	24	68
E2597060	6.0	6	24	68
E2597070	7.0	10	30	80
E2597080	8.0	10	38	88
E2597090	9.0	10	38	88
E2597100	10.0	10	45	95
E2597110	11.0	12	45	102
E2597120	12.0	12	53	110
E2597130	13.0	12	53	110
E2597140	14.0	12	53	110
E2597150	15.0	12	53	110
E2597160	16.0	16	63	123
E2597170	17.0	16	63	123
E2597180	18.0	16	63	123
E2597190	19.0	16	63	123
E2597200	20.0	20	75	141

- ▶ Other shank design on your request.
- ▶ TiN and TiCN Coatings are available on your request.

Mill Dia. Tolerance (mm)	Shank Dia. Tolerance
up to Ø6	0 ~ + 0.04
over Ø6	0 ~ + 0.05

◎ : Excellent ○ : Good

ISO Material Description	P										M				K						
	Non-alloy steel					Low alloy steel					High alloyed steel, and tool steel		Stainless steel		Grey cast iron	Nodular cast iron	Malleable cast iron				
VDI 3323	1	2	3	4	5	6	7	8	9	10	11	12	13	14	15	16	17	18	19	20	
HRc	13	25	28	32	30	10	29	32	38	15	35	15	23	10	10	26	3	25	21	21	
HB	125	190	250	270	300	180	275	300	350	200	325	200	240	180	180	260	160	250	130	230	
Recommend	◎	◎	◎	◎	◎	◎	◎	◎	◎	◎	◎	◎	◎	◎	◎	◎	◎	◎	◎	◎	◎

ISO Material Description	N										S					H						
	Aluminum-wrought alloy		Aluminum-cast, alloyed			Copper and Copper Alloys (Bronze / Brass)			Non Metallic Materials		Heat Resistant Super Alloys					Titanium Alloys		Hardened steel	Chilled Cast Iron	Hardened Cast Iron		
VDI 3323	21	22	23	24	25	26	27	28	29	30	31	32	33	34	35	36	37	38	39	40	41	
HRc	21	22	23	24	25	26	27	28	29	30	31	32	33	34	35	36	37	38	39	40	41	
HB	60	100	75	90	130	110	90	100			200	280	250	350	320	400 Rm	1050 Rm	550	630	400	550	
Recommend	○	○	○	○	○	○	○	○	○	○	○	○	○	○	○	○	○	○	○	○	○	○



FLAT SHANK **E2753** SERIES
FLAT SHANK **EQ753** SERIES

HSSCo8, MULTI FLUTE SHORT LENGTH ROUGHING - FINE

- HSSCo8, MULTI SCHNEIDEN KURZ SCHRUPPFRÄSER - FEIN
- Ⓢ Fraise HSSCo8, multi-dents ébauche, pas fin, courte
- Ⓢ MULTI TAGLIENTE, PER SGROSSATURA, SERIE CORTA, BOMBATO FINE - HSSCo8

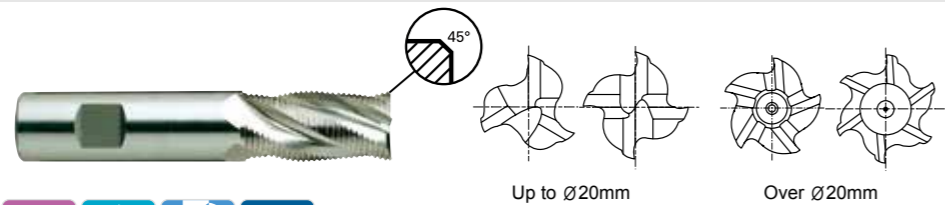

HSS Co8
DIN 844
HR
3-6
30°
DIN 1835B

~Ø20
Ø25~
C x 45°
UNCOATED
TiAIN

p.C692-695

Flat Shank	Page	Plain Shank	Page
END MILL HOLDER	D118-137	POWER MILLING CHUCK	D161-176
		ER COLLET CHUCK	D73-116
		SK SLIM CHUCK	D183-201

Unit : mm

EDP No.	Mill Diameter	Shank Diameter	Length of Cut	Overall Length	No. of Flute	Chamfer
E2753060	6.0	6	13	57	3	0.18
E2753070	7.0	10	16	66	3	0.18
E2753080	8.0	10	19	69	3	0.18
E2753090	9.0	10	19	69	3	0.18
E2753100	10.0	10	22	72	4	0.18
E2753110	11.0	12	22	79	4	0.18
E2753120	12.0	12	26	83	4	0.18
E2753130	13.0	12	26	83	4	0.18
E2753140	14.0	12	26	83	4	0.25
E2753150	15.0	12	26	83	4	0.25
E2753160	16.0	16	32	92	4	0.25
E2753180	18.0	16	32	92	4	0.25
E2753200	20.0	20	38	104	4	0.25
E2753250	25.0	25	45	121	5	0.36
E2753280	28.0	25	45	121	6	0.36
E2753300	30.0	25	45	121	6	0.36
E2753320	32.0	32	53	133	6	0.51
E2753350	35.0	32	53	133	6	0.51
E2753400	40.0	32	63	155	6	0.56

- ▶ Other shank design on your request.
- ▶ TiN and TiCN Coatings are available on your request.

Tolerances according to DIN 7160 & 7161

	Tolerance range in μm					
	Nominal-Diameter in mm					
	from 1 to 3	over 3 to 6	over 6 to 10	over 10 to 18	over 18 to 30	over 30 to 50
js12	±50	±60	±75	±90	±105	±125
h6	0 -6	0 -8	0 -9	0 -11	0 -13	0 -16

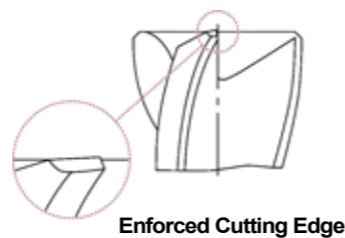

◎ : Excellent ○ : Good

ISO	P										M				K					
	Non-alloy steel					Low alloy steel					High alloyed steel, and tool steel				Stainless steel		Grey cast iron	Nodular cast iron	Malleable cast iron	
Material Description	1	2	3	4	5	6	7	8	9	10	11	12	13	14	15	16	17	18	19	20
VDI 3323	1	2	3	4	5	6	7	8	9	10	11	12	13	14	15	16	17	18	19	20
HRc	13	25	28	32	38	42	48	52	58	62	68	72	78	82	88	92	98	102	108	112
HB	125	190	250	270	300	180	275	300	350	200	325	200	240	180	180	260	3	25	130	230
Recommend	◎	◎	◎	◎	◎	◎	◎	◎	◎	◎	◎	◎	◎	◎	◎	◎	◎	◎	◎	◎



FLAT SHANK **E2762** SERIES
FLAT SHANK **EQ762** SERIES

HSSCo8, MULTI FLUTE LONG LENGTH ROUGHING - FINE

- HSSCo8, MULTI SCHNEIDEN LANG SCHRUPPFRÄSER - FEIN
- Ⓢ Fraise HSSCo8, multi-dents ébauche, pas fin, longue
- Ⓢ MULTI TAGLIENTE, PER SGROSSATURA, SERIE LUNGA, BOMBATO FINE - HSSCo8

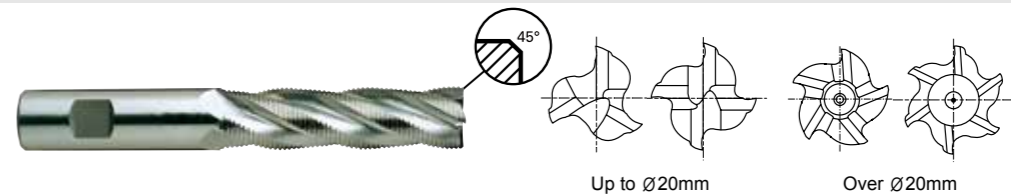

HSS Co8
DIN 844
HR
3-6
30°
DIN 1835B

~Ø20
Ø22~
C x 45°
UNCOATED
TiAIN

p.C692-695

Flat Shank	Page	Plain Shank	Page
END MILL HOLDER	D118-137	POWER MILLING CHUCK	D161-176
		ER COLLET CHUCK	D73-116
		SK SLIM CHUCK	D183-201

Unit : mm

EDP No.	Mill Diameter	Shank Diameter	Length of Cut	Overall Length	No. of Flute	Chamfer
E2762060	6.0	6	24	68	3	0.18
E2762070	7.0	10	30	80	3	0.18
E2762080	8.0	10	38	88	3	0.18
E2762090	9.0	10	38	88	3	0.18
E2762100	10.0	10	45	95	4	0.18
E2762110	11.0	12	45	102	4	0.18
E2762120	12.0	12	53	110	4	0.18
E2762130	13.0	12	53	110	4	0.18
E2762140	14.0	12	53	110	4	0.25
E2762150	15.0	12	53	110	4	0.25
E2762160	16.0	16	63	123	4	0.25
E2762170	17.0	16	63	123	4	0.25
E2762180	18.0	16	63	123	4	0.25
E2762190	19.0	16	63	123	4	0.25
E2762200	20.0	20	75	141	4	0.25
E2762220	22.0	20	75	141	5	0.36
E2762240	24.0	25	90	166	5	0.36
E2762250	25.0	25	90	166	5	0.36
E2762260	26.0	25	90	166	6	0.36
E2762280	28.0	25	90	166	6	0.36
E2762300	30.0	25	90	166	6	0.36
E2762320	32.0	32	106	186	6	0.51
E2762350	35.0	32	106	186	6	0.51
E2762360	36.0	32	106	186	6	0.56
E2762380	38.0	32	125	217	6	0.56
E2762400	40.0	32	125	217	6	0.56
E2762940	40.0	40	125	217	6	0.56

- ▶ Other shank design on your request.
- ▶ TiN and TiCN Coatings are available on your request.

Tolerances according to DIN 7160 & 7161

	Tolerance range in μm					
	Nominal-Diameter in mm					
	from 1 to 3	over 3 to 6	over 6 to 10	over 10 to 18	over 18 to 30	over 30 to 50
js12	±50	±60	±75	±90	±105	±125
h6	0 -6	0 -8	0 -9	0 -11	0 -13	0 -16

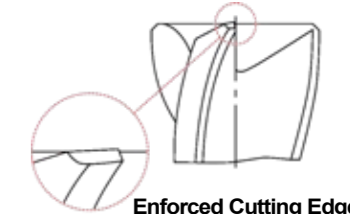

◎ : Excellent ○ : Good

ISO	P										M				K					
	Non-alloy steel					Low alloy steel					High alloyed steel, and tool steel				Stainless steel		Grey cast iron	Nodular cast iron	Malleable cast iron	
Material Description	1	2	3	4	5	6	7	8	9	10	11	12	13	14	15	16	17	18	19	20
VDI 3323	1	2	3	4	5	6	7	8	9	10	11	12	13	14	15	16	17	18	19	20
HRc	13	25	28	32	38	42	48	52	58	62	68	72	78	82	88	92	98	102	108	112
HB	125	190	250	270	300	180	275	300	350	200	325	200	240	180	180	260	3	25	130	230
Recommend	◎	◎	◎	◎	◎	◎	◎	◎	◎	◎	◎	◎	◎	◎	◎	◎	◎	◎	◎	◎



FLAT SHANK E2755 SERIES

HSSCo8, 3 FLUTE 37° HELIX SHORT LENGTH ROUGHING for ALUMINUM

HSSCo8, 3 SCHNEIDEN 37° RECHTSSPIRALE KURZ SCHRUPPFÄRÄSER für ALUMINIUM
Fraise HSSCo8, 3 dents, ébauche pour aluminium, hélice 37°, courte
3 TAGLIENTI, ELICA 37°, PER SGROSSATURA, SERIE CORTA - HSSCo8

for ALUMINIUM für ALUMINIUM



Material and coating icons: HSS Co8, DIN 844, WR, 3, 37°, DIN 1835B, UNCOATED, TiAlN, C x 45°, p.C700-701

Recommended ToolHolder table with columns for Flat Shank and Plain Shank, listing END MILL HOLDER, POWER MILLING CHUCK, ER COLLET CHUCK, and SK SLIM CHUCK with corresponding page numbers.

Unit : mm

Main product table with columns: EDP No., Mill Diameter, Shank Diameter, Length of Cut, Overall Length, Chamfer. Lists various sizes from 6.0 to 30.0 mm.

Other shank design on your request.
TiN and TiCN Coatings are available on your request.

Tolerances according to DIN 7160 & 7161

Tolerance range table showing values for different nominal diameters (from 1 to 3 mm to over 30 to 50 mm) and shank diameters (js12, h6).

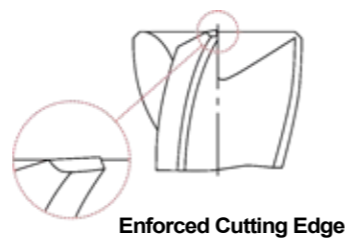

Enforced Cutting Edge

◎ : Excellent ○ : Good

ISO material compatibility chart with columns for P (Non-alloy steel, Low alloy steel, High alloyed steel, Stainless steel, Grey cast iron, Nodular cast iron, Malleable cast iron), N (Aluminum-wrought alloy, Aluminum-cast, alloyed, Copper and Copper Alloys, Non Metallic Materials), S (Heat Resistant Super Alloys, Titanium Alloys), and H (Hardened steel, Chilled Cast Iron, Hardened Cast Iron).



FLAT SHANK E2751 SERIES
FLAT SHANK EQ751 SERIES

HSSCo8, MULTI FLUTE SHORT LENGTH ROUGHING - COARSE

HSSCo8, MULTI SCHNEIDEN KURZ SCHRUPPFÄRÄSER - GROB
Fraise HSSCo8, multi-dents ébauche, pas grossier, courte
MULTI TAGLIENTE, PER SGROSSATURA, SERIE CORTA, BOMBATO GROSSO - HSSCo8

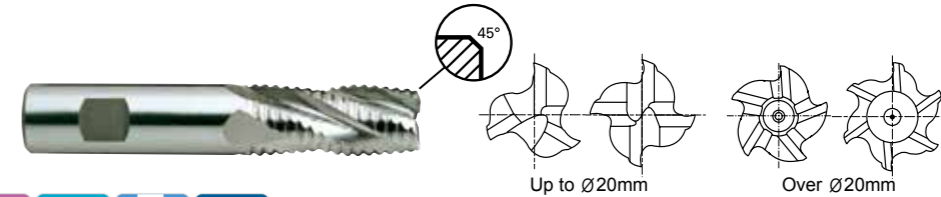

Material and coating icons: HSS Co8, DIN 844, NR, 3-6, 30°, DIN 1835B, UNCOATED, TiAlN, C x 45°, p.C692-695

Recommended ToolHolder table with columns for Flat Shank and Plain Shank, listing END MILL HOLDER, POWER MILLING CHUCK, ER COLLET CHUCK, and SK SLIM CHUCK with corresponding page numbers.

Unit : mm

Main product table with columns: EDP No., Mill Diameter, Shank Diameter, Length of Cut, Overall Length, No. of Flute, Chamfer. Lists various sizes from 6.0 to 22.0 mm.

Other shank design on your request.
TiN and TiCN Coatings are available on your request.

NEXT PAGE

Tolerances according to DIN 7160 & 7161

Tolerance range table showing values for different nominal diameters (from 1 to 3 mm to over 30 to 50 mm) and shank diameters (js12, h6).

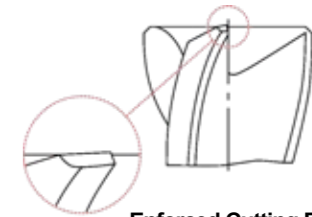

Enforced Cutting Edge

◎ : Excellent ○ : Good

ISO material compatibility chart with columns for P (Non-alloy steel, Low alloy steel, High alloyed steel, Stainless steel, Grey cast iron, Nodular cast iron, Malleable cast iron), N (Aluminum-wrought alloy, Aluminum-cast, alloyed, Copper and Copper Alloys, Non Metallic Materials), S (Heat Resistant Super Alloys, Titanium Alloys), and H (Hardened steel, Chilled Cast Iron, Hardened Cast Iron).



FLAT SHANK **E2751** SERIES
FLAT SHANK **EQ751** SERIES



FLAT SHANK **E2752** SERIES
FLAT SHANK **EQ752** SERIES

HSSCo8, MULTI FLUTE SHORT LENGTH ROUGHING - COARSE

HSSCo8, MULTI FLUTE LONG LENGTH ROUGHING - COARSE

● HSSCo8, MULTI SCHNEIDEN KURZ SCHRUPPFRÄSER - GROB
Ⓢ Fraise HSSCo8, multi-dents ébauche, pas grossier, courte
Ⓢ MULTI TAGLIENTE, PER SGROSSATURA, SERIE CORTA, BOMBATO GROSSO - HSSCo8

● HSSCo8, MULTI SCHNEIDEN LANG SCHRUPPFRÄSER - GROB
Ⓢ Fraise HSSCo8, multi-dents ébauche, pas grossier, longue
Ⓢ MULTI TAGLIENTE, PER SGROSSATURA, SERIE LUNGA, BOMBATO GROSSO - HSSCo8

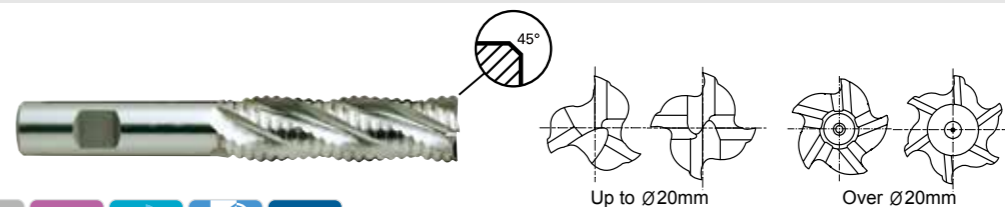
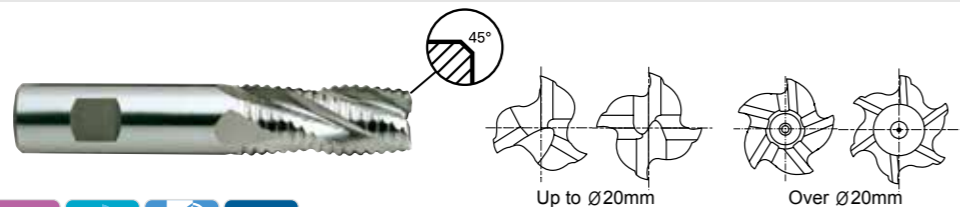

HSS Co8, DIN 844, NR, 3-6, 30°, DIN 1835B, UNCOATED, TiAIN, p.C692-695

HSS Co8, DIN 844, NR, 3-6, 30°, DIN 1835B, UNCOATED, TiAIN, p.C692-695

Flat Shank	Page	Plain Shank	Page
END MILL HOLDER	D118-137	POWER MILLING CHUCK	D161-176
ER COLLET CHUCK	D73-116	SK SLIM CHUCK	D183-201

Flat Shank	Page	Plain Shank	Page
END MILL HOLDER	D118-137	POWER MILLING CHUCK	D161-176
ER COLLET CHUCK	D73-116	SK SLIM CHUCK	D183-201

EDP No.	Mill Diameter		Shank Diameter	Length of Cut	Overall Length	No. of Flute	Chamfer
	UNCOATED	TiAIN					
E2751240	EQ751240	24.0	25	45	121	5	0.55
E2751250	EQ751250	25.0	25	45	121	5	0.55
E2751260	EQ751260	26.0	25	45	121	6	0.55
E2751280	EQ751280	28.0	25	45	121	6	0.70
E2751300	EQ751300	30.0	25	45	121	6	0.70
E2751320	EQ751320	32.0	32	53	133	6	0.70
E2751340	EQ751340	34.0	32	53	133	6	0.70
E2751350	EQ751350	35.0	32	53	133	6	0.70
E2751360	EQ751360	36.0	32	53	133	6	0.70
E2751380	EQ751380	38.0	32	63	155	6	0.70
E2751938	EQ751938	38.0	40	63	155	6	0.70
E2751400	EQ751400	40.0	32	63	155	6	0.88
E2751940	EQ751940	40.0	40	63	155	6	0.88
E2751450	EQ751450	45.0	32	63	143	6	0.88
E2751500	EQ751500	50.0	50	75	177	6	0.88

EDP No.	Mill Diameter		Shank Diameter	Length of Cut	Overall Length	No. of Flute	Chamfer
	UNCOATED	TiAIN					
E2752060	EQ752060	6.0	6	24	68	3	0.25
E2752070	EQ752070	7.0	10	30	80	3	0.25
E2752080	EQ752080	8.0	10	38	88	3	0.25
E2752090	EQ752090	9.0	10	38	88	3	0.34
E2752100	EQ752100	10.0	10	45	95	4	0.34
E2752110	EQ752110	11.0	12	45	102	4	0.50
E2752120	EQ752120	12.0	12	53	110	4	0.50
E2752130	EQ752130	13.0	12	53	110	4	0.50
E2752140	EQ752140	14.0	12	53	110	4	0.55
E2752150	EQ752150	15.0	12	53	110	4	0.55
E2752160	EQ752160	16.0	16	63	123	4	0.55
E2752170	EQ752170	17.0	16	63	123	4	0.55
E2752180	EQ752180	18.0	16	63	123	4	0.55
E2752190	EQ752190	19.0	16	63	123	4	0.55
E2752200	EQ752200	20.0	20	75	141	4	0.55
E2752901	EQ752901	20.0	16	75	135	4	0.55
E2752220	EQ752220	22.0	20	75	141	5	0.55
E2752902	EQ752902	22.0	25	75	151	5	0.55

▶ Other shank design on your request.
▶ TiN and TiCN Coatings are available on your request.

▶ Other shank design on your request.
▶ TiN and TiCN Coatings are available on your request.

Tolerances according to DIN 7160 & 7161

	Tolerance range in μ m					
	Nominal-Diameter in mm					
	from 1 to 3	over 3 to 6	over 6 to 10	over 10 to 18	over 18 to 30	over 30 to 50
js12	± 50	± 60	± 75	± 90	± 105	± 125
h6	0 -6	0 -8	0 -9	0 -11	0 -13	0 -16

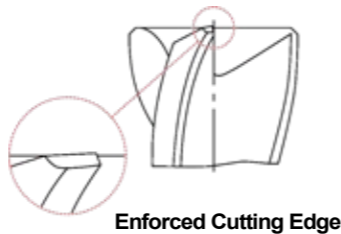

Enforced Cutting Edge

Tolerances according to DIN 7160 & 7161

	Tolerance range in μ m					
	Nominal-Diameter in mm					
	from 1 to 3	over 3 to 6	over 6 to 10	over 10 to 18	over 18 to 30	over 30 to 50
js12	± 50	± 60	± 75	± 90	± 105	± 125
h6	0 -6	0 -8	0 -9	0 -11	0 -13	0 -16

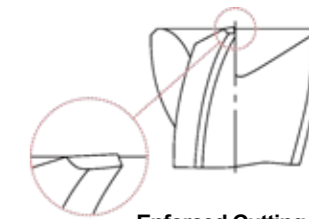

Enforced Cutting Edge

◎ : Excellent ○ : Good

ISO	P												M			K						
	Non-alloy steel				Low alloy steel				High alloyed steel, and tool steel				Stainless steel			Grey cast iron	Nodular cast iron		Malleable cast iron			
Material Description	1	2	3	4	5	6	7	8	9	10	11	12	13	14	15	16	17	18	19	20		
VDI 3323	13	25	28	32	10	29	32	38	15	35	15	23	10	10	26	3	25	21				
HRc	125	190	250	270	300	180	275	300	350	200	325	200	240	180	180	260	160	250	130	230		
HB																						
Recommend	◎	◎	◎	◎	◎	◎	◎	◎	◎	◎	◎	◎	◎	◎	◎	◎	◎	◎	◎	◎	◎	
ISO	N								S					H								
	Aluminum-wrought alloy		Aluminum-cast, alloyed		Copper and Copper Alloys (Bronze / Brass)		Non Metallic Materials		Heat Resistant Super Alloys					Titanium Alloys	Hardened steel	Chilled Cast Iron	Hardened Cast Iron					
Material Description	21	22	23	24	25	26	27	28	29	30	31	32	33	34	35	36	37	38	39	40	41	
VDI 3323	21	22	23	24	25	26	27	28	29	30	31	32	33	34	35	36	37	38	39	40	41	
HRc	15	30	25	38	34	200	280	250	350	320	400 Rm	1050 Rm	550	630	400	550	55	60	42	55	55	
HB	60	100	75	90	130	110	90	100														
Recommend	◎	◎	◎	◎	◎	◎	◎	◎	◎	◎	◎	◎	◎	◎	◎	◎	◎	◎	◎	◎	◎	◎

◎ : Excellent ○ : Good

ISO	P												M			K						
	Non-alloy steel				Low alloy steel				High alloyed steel, and tool steel				Stainless steel			Grey cast iron	Nodular cast iron		Malleable cast iron			
Material Description	1	2	3	4	5	6	7	8	9	10	11	12	13	14	15	16	17	18	19	20		
VDI 3323	13	25	28	32	10	29	32	38	15	35	15	23	10	10	26	3	25	21				
HRc	125	190	250	270	300	180	275	300	350	200	325	200	240	180	180	260	160	250	130	230		
HB																						
Recommend	◎	◎	◎	◎	◎	◎	◎	◎	◎	◎	◎	◎	◎	◎	◎	◎	◎	◎	◎	◎	◎	
ISO	N								S					H								
	Aluminum-wrought alloy		Aluminum-cast, alloyed		Copper and Copper Alloys (Bronze / Brass)		Non Metallic Materials		Heat Resistant Super Alloys					Titanium Alloys	Hardened steel	Chilled Cast Iron	Hardened Cast Iron					
Material Description	21	22	23	24	25	26	27	28	29	30	31	32	33	34	35	36	37	38	39	40	41	
VDI 3323	21	22	23	24	25	26	27	28	29	30	31	32	33	34	35	36	37	38	39	40	41	
HRc	15	30	25	38	34	200	280	250	350	320	400 Rm	1050 Rm	550	630	400	550	55	60	42	55	55	
HB	60	100	75	90	130	110	90	100														
Recommend	◎	◎	◎	◎	◎	◎	◎	◎	◎	◎	◎	◎	◎	◎	◎	◎	◎	◎	◎	◎	◎	◎



FLAT SHANK **E2752** SERIES
 FLAT SHANK **EQ752** SERIES

HSSCo8, MULTI FLUTE LONG LENGTH ROUGHING - COARSE

- HSSCo8, MULTI SCHNEIDEN LANG SCHRUPPFÄSER - GROB
- Fraise HSSCo8, multi-dents ébauche, pas grossier, longue
- MULTI TAGLIENTE, PER SGROSSATURA, SERIE LUNGA, BOMBATO GROSSO - HSSCo8

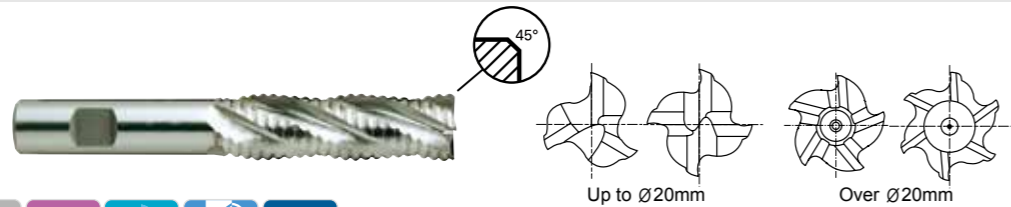

Flat Shank	Page	Plain Shank	Page
END MILL HOLDER	D118-137	POWER MILLING CHUCK	D161-176
ER COLLET CHUCK	D73-116	SK SLIM CHUCK	D183-201

EDP No.	Mill Diameter	Shank Diameter	Length of Cut	Overall Length	No. of Flute	Chamfer	
							UNCOATED
E2752240	EQ752240	24.0	25	90	166	5	0.55
E2752250	EQ752250	25.0	25	90	166	5	0.55
E2752260	EQ752260	26.0	25	90	166	6	0.55
E2752280	EQ752280	28.0	25	90	166	6	0.70
E2752300	EQ752300	30.0	25	90	166	6	0.70
E2752320	EQ752320	32.0	32	106	186	6	0.70
E2752350	EQ752350	35.0	32	106	186	6	0.70
E2752360	EQ752360	36.0	32	106	186	6	0.70
E2752380	EQ752380	38.0	32	125	217	6	0.70
E2752938	EQ752938	38.0	40	125	217	6	0.70
E2752400	EQ752400	40.0	32	125	217	6	0.88
E2752940	EQ752940	40.0	40	125	217	6	0.88

▶ Other shank design on your request.
 ▶ TiN and TiCN Coatings are available on your request.

Tolerances according to DIN 7160 & 7161

	Tolerance range in μm					
	Nominal-Diameter in mm					
	from 1 to 3	over 3 to 6	over 6 to 10	over 10 to 18	over 18 to 30	over 30 to 50
js12	±50	±60	±75	±90	±105	±125
h6	0 -6	0 -8	0 -9	0 -11	0 -13	0 -16

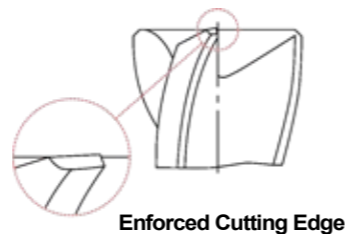

◎ : Excellent ○ : Good

ISO	P											M				K						
	Non-alloy steel					Low alloy steel						High alloyed steel, and tool steel				Stainless steel		Grey cast iron		Nodular cast iron		Malleable cast iron
Material Description	1	2	3	4	5	6	7	8	9	10	11	12	13	14	15	16	17	18	19	20		
VDI 3323	13	25	28	32	10	29	32	38	15	35	15	23	10	10	26	3	25	21				
HRC	125	190	250	270	300	180	275	300	350	200	325	200	240	180	180	260	160	250	130	230		
HB	◎	◎	◎	◎	◎	◎	◎	◎	◎	◎	◎	◎	◎	◎	◎	◎	◎	◎	◎	◎		
Recommend	◎	◎	◎	◎	◎	◎	◎	◎	◎	◎	◎	◎	◎	◎	◎	◎	◎	◎	◎	◎		

ISO	N										S						H						
	Aluminum-wrought alloy		Aluminum-cast, alloyed		Copper and Copper Alloys (Bronze / Brass)				Non Metallic Materials		Heat Resistant Super Alloys						Titanium Alloys		Hardened steel		Chilled Cast Iron		Hardened Cast Iron
Material Description	21	22	23	24	25	26	27	28	29	30	31	32	33	34	35	36	37	38	39	40	41		
VDI 3323	15	30	25	38	34						15	30	25	38	34	400 Rm	1050 Rm	55	60	42	55		
HRC	60	100	75	90	130	110	90	100			200	280	250	350	320	400 Rm	1050 Rm	550	630	400	550		
HB	◎	◎	◎	◎	◎	◎	◎	◎	◎	◎	◎	◎	◎	◎	◎	◎	◎	◎	◎	◎	◎		
Recommend	◎	◎	◎	◎	◎	◎	◎	◎	◎	◎	◎	◎	◎	◎	◎	◎	◎	◎	◎	◎	◎		



RECOMMENDED CUTTING CONDITIONS EMPFOHLENE SCHNEIDPARAMETER

E2535, E2492 SERIES 2 FLUTE BALL NOSE

Vc = m/min.
 fz = mm/tooth
 RPM = rev./min.
 FEED = mm/min.

ISO	VDI 3323	Material Description	Ae	Ap	Parameter	Diameter (Ø)											
						3.0	4.0	6.0	8.0	10.0	12.0	16.0	20.0	25.0			
P	1	Non-alloy steel	0.7D	0.3D	Vc	40	40	40	40	40	40	40	40	40	40	40	
					fz	0.011	0.018	0.031	0.05	0.069	0.085	0.094	0.117	0.13			
					RPM	4244	3183	2122	1592	1273	1061	796	637	509			
	2		0.7D	0.3D	Vc	30	30	30	30	30	30	30	30	30	30	30	
					fz	0.01	0.017	0.026	0.044	0.06	0.066	0.083	0.085	0.088			
					RPM	3183	2387	1592	1194	955	796	597	477	382			
	3-4		0.7D	0.3D	Vc	20	20	20	20	20	15	20	20	20	15		
					fz	0.008	0.013	0.023	0.036	0.054	0.061	0.079	0.083	0.091			
					RPM	2122	1592	1061	796	637	398	398	318	191			
	5		0.7D	0.3D	Vc	15	15	15	15	15	10	15	15	15	15		
					fz	0.007	0.013	0.018	0.03	0.044	0.055	0.07	0.088	0.094			
RPM		1592			1194	796	597	477	265	298	239	191					
6	0.7D	0.3D	Vc	30	30	30	30	30	30	30	30	30	30				
			fz	0.01	0.017	0.026	0.044	0.06	0.066	0.083	0.085	0.088					
			RPM	3183	2387	1592	1194	955	796	597	477	382					
7	0.7D	0.3D	Vc	20	20	20	20	20	15	20	20	15					
			fz	0.008	0.013	0.023	0.036	0.054	0.061	0.079	0.083	0.091					
			RPM	2122	1592	1061	796	637	398	398	318	191					
8-9	0.7D	0.3D	Vc	15	15	15	15	15	10	15	15	15					
			fz	0.007	0.013	0.018	0.03	0.044	0.055	0.07	0.088	0.094					
			RPM	1592	1194	796	597	477	265	298	239	191					
10	0.7D	0.3D	Vc	30	30	30	30	30	30	30	30	30	30				
			fz	0.01	0.017	0.026	0.044	0.06	0.066	0.083	0.085	0.088					
			RPM	3183	2387	1592	1194	955	796	597	477	382					
11.1	0.7D	0.3D	Vc	15	15	15	15	15	10	15	15	15					
			fz	0.007	0.013	0.018	0.03	0.044	0.055	0.07	0.088	0.094					
			RPM	1592	1194	796	597	477	265	298	239	191					
21-22	0.7D	0.3D	Vc	105	100	105	100	100	95	100	100	100					
			fz	0.01	0.016	0.025	0.044	0.056	0.068	0.075	0.088	0.096					
			RPM	11141	7958	5570	3979	3183	2520	1989	1592	1273					
23-24	0.7D	0.3D	Vc	68	65	68	65	65	62	65	65	65					
			fz	0.01	0.016	0.025	0.044	0.056	0.068	0.075	0.088	0.096					
			RPM	7215	5173	3608	2586	2069	1645	1293	1035	828					

※The FEED, in long & extra long types, should be reduced by around 50%

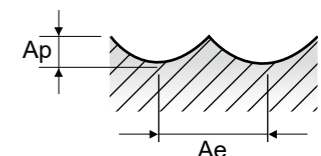



RECOMMENDED CUTTING CONDITIONS
EMPFOHLENE SCHNEIDPARAMETER

EQ535, EQ492 SERIES 2 FLUTE BALL NOSE TIAN COATED

Vc = m/min.
fz = mm/tooth
RPM = rev./min.
FEED = mm/min.

ISO	VDI 3323	Material Description	Ae	Ap	Parameter	Diameter (Ø)										
						3.0	4.0	6.0	8.0	10.0	12.0	16.0	20.0	25.0		
P	1	Non-alloy steel	0.7D	0.3D	Vc	60	55	60	55	55	55	55	55	55	55	55
					fz	0.011	0.018	0.031	0.05	0.069	0.086	0.095	0.115	0.129		
					RPM	6366	4377	3183	2188	1751	1459	1094	875	700		
					FEED	140	158	197	219	242	251	208	201	181		
	2		Vc	45	40	45	45	45	40	45	45	45	45			
			fz	0.011	0.016	0.026	0.043	0.061	0.066	0.082	0.086	0.091				
			RPM	4775	3183	2387	1790	1432	1061	895	716	573				
	3-4		Vc	25	25	25	25	25	25	25	25	25	25			
			fz	0.007	0.013	0.023	0.035	0.053	0.058	0.075	0.088	0.092				
			RPM	2653	1989	1326	995	796	663	497	398	318				
	5		Vc	20	20	20	20	15	15	20	20	15				
fz		0.008	0.013	0.018	0.029	0.045	0.056	0.071	0.083	0.1						
RPM		2122	1592	1061	796	477	398	398	318	191						
6	Vc	45	40	45	45	45	40	45	45	45						
	fz	0.011	0.016	0.026	0.043	0.061	0.066	0.082	0.086	0.091						
	RPM	4775	3183	2387	1790	1432	1061	895	716	573						
7	Vc	25	25	25	25	25	25	25	25	25						
	fz	0.007	0.013	0.023	0.035	0.053	0.058	0.075	0.088	0.092						
	RPM	2653	1989	1326	995	796	663	497	398	318						
8-9	Vc	20	20	20	20	15	15	20	20	15						
	fz	0.008	0.013	0.018	0.029	0.045	0.056	0.071	0.083	0.1						
	RPM	2122	1592	1061	796	477	398	398	318	191						
10	Vc	45	40	45	45	45	40	45	45	45						
	fz	0.011	0.016	0.026	0.043	0.061	0.066	0.082	0.086	0.091						
	RPM	4775	3183	2387	1790	1432	1061	895	716	573						
11.1	Vc	20	20	20	20	15	15	20	20	15						
	fz	0.008	0.013	0.018	0.029	0.045	0.056	0.071	0.083	0.1						
	RPM	2122	1592	1061	796	477	398	398	318	191						
N	21-22	Aluminum-wrought alloy	0.7D	0.3D	Vc	145	140	150	140	140	130	140	140	140		
					fz	0.01	0.016	0.025	0.044	0.056	0.068	0.075	0.087	0.097		
					RPM	15385	11141	7958	5570	4456	3448	2785	2228	1783		
	23-24		Aluminum-cast, alloyed	0.7D	0.3D	Vc	94	91	98	91	91	85	91	91	91	
						fz	0.01	0.016	0.025	0.044	0.056	0.068	0.075	0.087	0.097	
						RPM	9974	7242	5199	3621	2897	2255	1810	1448	1159	
FEED	199	232		260	319	324	307	272	252	225						

※The FEED, in long & extra long types, should be reduced by around 50%

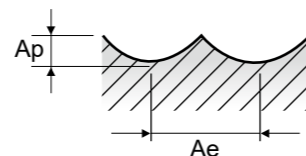

RECOMMENDED CUTTING CONDITIONS
EMPFOHLENE SCHNEIDPARAMETER

EL612 SERIES 1 FLUTE - SLOTTING

Vc = m/min.
fz = mm/tooth
RPM = rev./min.
FEED = mm/min.

ISO	VDI 3323	Material Description	Ae	Ap	Parameter	Diameter (Ø)						
						3.0	4.0	5.0	6.0	7.0	8.0	10.0
N	21-22	Aluminum-wrought alloy	1.0D	0.5D (~Ø:0.2D)	Vc	188	226	220	207	220	214	220
					fz	0.055	0.053	0.054	0.055	0.055	0.053	0.054
					RPM	19947	17985	14006	10982	10004	8515	7003
	23-24	Aluminum-cast, alloyed	1.0D	0.5D (~Ø:0.2D)	Vc	122	147	143	135	143	139	143
					fz	0.055	0.053	0.054	0.055	0.055	0.053	0.054
					RPM	12945	11698	9104	7162	6503	5531	4552
FEED	712	620	492	394	358	293	246					

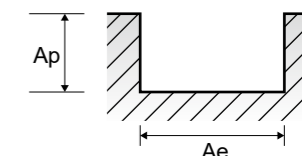

E2464, E2509 SERIES 2 FLUTE - SLOTTING

ISO	VDI 3323	Material Description	Ae	Ap	Parameter	Diameter (Ø)								
						3.0	6.0	8.0	10.0	12.0	14.0	16.0	18.0	20.0
N	21-22	Aluminum-wrought alloy	1.0D	0.5D	Vc	75	130	150	155	190	155	175	130	145
					fz	0.035	0.05	0.071	0.12	0.12	0.177	0.177	0.283	0.283
					RPM	7958	6897	5968	4934	5040	3524	3482	2299	2308
	23-24	Aluminum-cast, alloyed	1.0D	0.5D	Vc	49	85	98	101	124	101	114	85	94
					fz	0.035	0.05	0.071	0.12	0.12	0.177	0.177	0.283	0.283
					RPM	5199	4509	3899	3215	3289	2296	2268	1503	1496
FEED	364	451	554	772	789	813	803	851	847					

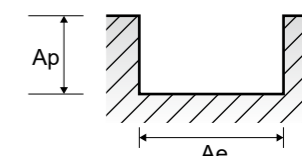

E2464, E2509 SERIES 2 FLUTE - SITE CUTTING

ISO	VDI 3323	Material Description	Ae	Ap	Parameter	Diameter (Ø)								
						3.0	6.0	8.0	10.0	12.0	14.0	16.0	18.0	20.0
N	21-22	Aluminum-wrought alloy	Ø3~Ø10=0.25D Ø12~Ø20=0.5D	1.0D	Vc	75	130	150	155	190	155	175	130	145
					fz	0.046	0.064	0.092	0.15	0.15	0.229	0.229	0.37	0.37
					RPM	732	883	1098	1480	1512	1614	1595	1701	1708
	23-24	Aluminum-cast, alloyed	Ø3~Ø10=0.25D Ø12~Ø20=0.5D	1.0D	Vc	49	85	98	101	124	101	114	85	94
					fz	0.046	0.064	0.092	0.15	0.15	0.229	0.229	0.37	0.37
					RPM	5199	4509	3899	3215	3289	2296	2268	1503	1496
FEED	478	577	717	964	987	1052	1039	1112	1107					

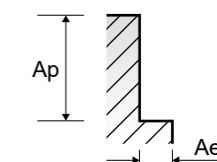



RECOMMENDED CUTTING CONDITIONS
EMPFOHLENE SCHNEIDPARAMETER

E2570, E2571, E2510 SERIES 2 FLUTE - SLOTTING

Vc = m/min.
fz = mm/tooth
RPM = rev./min.
FEED = mm/min.

ISO	VDI 3323	Material Description	Ae	Ap	Parameter	Diameter (Ø)							
						2.0	3.0	4.0	5.0	6.0	8.0	10.0	12.0
P	1	Non-alloy steel	1.0D	0.5D	Vc	35	35	35	35	35	35	35	35
					fz	0.004	0.008	0.013	0.02	0.025	0.036	0.045	0.061
					RPM	5570	3714	2785	2228	1857	1393	1114	928
	2		Vc	30	30	30	30	30	30	30	30		
			fz	0.003	0.007	0.013	0.019	0.025	0.041	0.05	0.063		
			RPM	4775	3183	2387	1910	1592	1194	955	796		
	3-4		Vc	25	25	25	25	25	25	25	25		
			fz	0.004	0.008	0.013	0.019	0.025	0.039	0.05	0.063		
			RPM	3979	2653	1989	1592	1326	995	796	663		
	5		Vc	15	15	15	15	15	15	15	15		
			fz	0.003	0.006	0.014	0.019	0.025	0.04	0.05	0.063		
RPM		2387	1592	1194	955	796	597	477	398				
6	Vc	30	30	30	30	30	30	30	30				
	fz	0.003	0.007	0.013	0.019	0.025	0.041	0.05	0.063				
	RPM	4775	3183	2387	1910	1592	1194	955	796				
7	Vc	25	25	25	25	25	25	25	25				
	fz	0.004	0.008	0.013	0.019	0.025	0.039	0.05	0.063				
	RPM	3979	2653	1989	1592	1326	995	796	663				
8-9	Vc	15	15	15	15	15	15	15	15				
	fz	0.003	0.006	0.014	0.019	0.025	0.04	0.05	0.063				
	RPM	2387	1592	1194	955	796	597	477	398				
10	Vc	30	30	30	30	30	30	30	30				
	fz	0.003	0.007	0.013	0.019	0.025	0.041	0.05	0.063				
	RPM	4775	3183	2387	1910	1592	1194	955	796				
11.1	Vc	15	15	15	15	15	15	15	15				
	fz	0.003	0.006	0.014	0.019	0.025	0.04	0.05	0.063				
	RPM	2387	1592	1194	955	796	597	477	398				
N	21-22	Aluminum-wrought alloy	1.0D	0.5D	Vc	75	105	100	100	105	100	95	95
					fz	0.007	0.011	0.018	0.025	0.028	0.049	0.065	0.076
					RPM	11937	11141	7958	6366	5570	3979	3024	2520
23-24	Aluminum-cast, alloyed	1.0D	0.5D	Vc	49	68	65	65	68	65	62	62	
				fz	0.007	0.011	0.018	0.025	0.028	0.049	0.065	0.076	
				RPM	7799	7215	5173	4138	3608	2586	1974	1645	
FEED	109	159	186	207	202	253	257	250					

※The FEED, in long & extra long types, should be reduced by around 50%

▶ NEXT PAGE

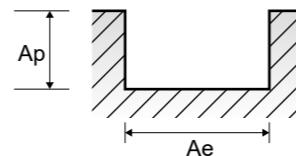

RECOMMENDED CUTTING CONDITIONS
EMPFOHLENE SCHNEIDPARAMETER

E2570, E2571, E2510 SERIES 2 FLUTE - SLOTTING

Vc = m/min.
fz = mm/tooth
RPM = rev./min.
FEED = mm/min.

VDI 3323	Parameter	Diameter (Ø)											
		14.0	16.0	18.0	20.0	22.0	25.0	28.0	30.0	32.0	36.0	40.0	
1	Vc	35	35	35	35	35	35	35	35	35	35	35	35
	fz	0.069	0.079	0.079	0.089	0.1	0.1	0.1	0.1	0.1	0.097	0.107	0.107
	RPM	796	696	619	557	506	446	398	371	348	309	279	279
	FEED	110	110	98	99	101	89	80	74	70	60	60	60
2	Vc	30	30	30	30	30	30	30	30	30	30	30	30
	fz	0.064	0.08	0.09	0.1	0.1	0.1	0.097	0.098	0.1	0.098	0.1	0.114
	RPM	682	597	531	477	434	382	341	318	298	265	239	239
	FEED	87	95	95	95	87	76	68	62	58	53	54	54
3-4	Vc	25	25	25	25	25	25	25	25	25	25	25	25
	fz	0.071	0.078	0.088	0.088	0.1	0.097	0.098	0.1	0.102	0.1	0.111	0.111
	RPM	568	497	442	398	362	318	284	265	199	221	199	199
	FEED	81	78	78	70	72	62	56	53	41	44	44	44
5	Vc	15	15	15	15	15	15	15	15	15	15	15	15
	fz	0.071	0.08	0.09	0.102	0.102	0.097	0.094	0.094	0.107	0.104	0.114	0.114
	RPM	341	298	265	239	217	191	171	159	149	133	119	119
	FEED	48	48	48	49	44	37	32	30	32	28	27	27
6	Vc	30	30	30	30	30	30	30	30	30	30	30	30
	fz	0.064	0.08	0.09	0.1	0.1	0.1	0.097	0.098	0.1	0.098	0.1	0.114
	RPM	682	597	531	477	434	382	341	318	298	265	239	239
	FEED	87	95	95	95	87	76	68	62	58	53	54	54
7	Vc	25	25	25	25	25	25	25	25	25	25	25	25
	fz	0.071	0.078	0.088	0.088	0.1	0.097	0.098	0.1	0.102	0.1	0.111	0.111
	RPM	568	497	442	398	362	318	284	265	199	221	199	199
	FEED	81	78	78	70	72	62	56	53	41	44	44	44
8-9	Vc	15	15	15	15	15	15	15	15	15	15	15	15
	fz	0.071	0.08	0.09	0.102	0.102	0.097	0.094	0.094	0.107	0.104	0.114	0.114
	RPM	341	298	265	239	217	191	171	159	149	133	119	119
	FEED	48	48	48	49	44	37	32	30	32	28	27	27
10	Vc	30	30	30	30	30	30	30	30	30	30	30	30
	fz	0.064	0.08	0.09	0.1	0.1	0.1	0.097	0.098	0.1	0.098	0.1	0.114
	RPM	682	597	531	477	434	382	341	318	298	265	239	239
	FEED	87	95	95	95	87	76	68	62	58	53	54	54
11.1	Vc	15	15	15	15	15	15	15	15	15	15	15	15
	fz	0.071	0.08	0.09	0.102	0.102	0.097	0.094	0.094	0.107	0.104	0.114	0.114
	RPM	341	298	265	239	217	191	171	159	149	133	119	119
	FEED	48	48	48	49	44	37	32	30	32	28	27	27
21-22	Vc	95	100	100	100	95	95	95	95	105	100	100	100
	fz	0.08	0.088	0.097	0.1	0.107	0.117	0.123	0.123	0.12	0.122	0.125	0.125
	RPM	2160	1989	1768	1592	1375	1210	1080	1114	995	884	796	796
	FEED	346	350	343	318	294	283	266	274	239	216	199	199
23-24	Vc	62	65	65	65	62	62	62	62	68	65	65	65
	fz	0.08	0.088	0.097	0.1	0.107	0.117	0.123	0.123	0.12	0.122	0.125	0.125
	RPM	1410	1293	1149	1035	897	789	705	722	647	575	517	517
	FEED	226	228	223	207	192	185	173	177	155	140	129	129

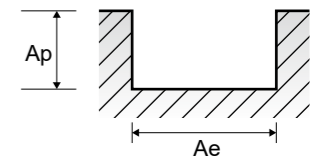

EQ570, EQ571, EQ510 SERIES 2 FLUTE TiAlN COATED - **SLOTING**

Vc = m/min.
fz = mm/tooth
RPM = rev./min.
FEED = mm/min.

ISO	VDI 3323	Material Description	Ae	Ap	Parameter	Diameter (Ø)								
						2.0	3.0	4.0	5.0	6.0	8.0	10.0	12.0	
P	1	Non-alloy steel	1.0D	0.5D	Vc	50	45	50	50	45	50	50	45	
					fz	0.004	0.008	0.013	0.02	0.025	0.036	0.045	0.062	
					RPM	7958	4775	3979	3183	2387	1989	1592	1194	
	2		Vc	40	40	40	40	40	40	40	40			
			fz	0.003	0.007	0.012	0.02	0.024	0.04	0.05	0.064			
			RPM	6366	4244	3183	2546	2122	1592	1273	1061			
	3-4		Vc	35	35	30	35	30	30	35	35			
			fz	0.004	0.008	0.013	0.019	0.025	0.04	0.05	0.061			
			RPM	5570	3714	2387	2228	1592	1194	1114	928			
	5		Vc	20	20	20	20	20	20	20	20			
			fz	0.003	0.007	0.013	0.02	0.025	0.041	0.05	0.064			
RPM		3183	2122	1592	1273	1061	796	637	531					
6	Vc	40	40	40	40	40	40	40	40					
	fz	0.003	0.007	0.012	0.02	0.024	0.04	0.05	0.064					
	RPM	6366	4244	3183	2546	2122	1592	1273	1061					
7	Vc	35	35	30	35	30	30	35	35					
	fz	0.004	0.008	0.013	0.019	0.025	0.04	0.05	0.061					
	RPM	5570	3714	2387	2228	1592	1194	1114	928					
8-9	Vc	20	20	20	20	20	20	20	20					
	fz	0.003	0.007	0.013	0.02	0.025	0.041	0.05	0.064					
	RPM	3183	2122	1592	1273	1061	796	637	531					
10	Vc	40	40	40	40	40	40	40	40					
	fz	0.003	0.007	0.012	0.02	0.024	0.04	0.05	0.064					
	RPM	6366	4244	3183	2546	2122	1592	1273	1061					
11.1	Vc	20	20	20	20	20	20	20	20					
	fz	0.003	0.007	0.013	0.02	0.025	0.041	0.05	0.064					
	RPM	3183	2122	1592	1273	1061	796	637	531					
N	21-22	Aluminum-wrought alloy	1.0D	0.5D	Vc	105	145	140	140	150	140	135	130	
					fz	0.007	0.011	0.018	0.025	0.028	0.049	0.064	0.076	
	RPM		16711	15385	11141	8913	7958	5570	4297	3448				
	FEED		234	338	401	446	446	546	550	524				
	23-24		Aluminum-cast, alloyed	1.0D	0.5D	Vc	68	94	91	91	98	91	88	85
						fz	0.007	0.011	0.018	0.025	0.028	0.049	0.064	0.076
RPM	10823	9974		7242	5793	5199	3621	2801	2255					
FEED	152	219		261	290	291	355	359	343					

※The FEED, in long & extra long types, should be reduced by around 50%

▶ NEXT PAGE

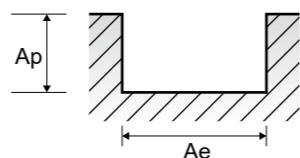

EQ570, EQ571, EQ510 SERIES 2 FLUTE TiAlN COATED - **SLOTING**

Vc = m/min.
fz = mm/tooth
RPM = rev./min.
FEED = mm/min.

VDI 3323	Parameter	Diameter (Ø)										
		14.0	16.0	18.0	20.0	22.0	25.0	28.0	30.0	32.0	36.0	40.0
1	Vc	50	50	50	50	50	50	50	45	50	50	50
	fz	0.07	0.078	0.078	0.088	0.1	0.096	0.1	0.1	0.1	0.094	0.106
	RPM	1137	995	884	796	723	637	568	477	442	442	398
2	Vc	45	40	40	40	45	45	45	40	40	40	40
	fz	0.063	0.078	0.089	0.096	0.096	0.1	0.1	0.094	0.094	0.1	0.117
	RPM	1023	796	707	637	651	573	512	424	398	354	318
3-4	Vc	35	35	30	35	35	35	35	30	30	35	30
	fz	0.069	0.077	0.091	0.091	0.1	0.094	0.094	0.1	0.108	0.092	0.11
	RPM	796	696	531	557	506	446	398	371	298	309	239
5	Vc	20	20	20	20	20	20	20	20	20	15	20
	fz	0.07	0.081	0.093	0.108	0.108	0.1	0.1	0.1	0.1	0.117	0.117
	RPM	455	398	354	318	289	255	227	199	133	159	159
6	Vc	45	40	40	40	45	45	45	40	40	40	40
	fz	0.063	0.078	0.089	0.096	0.096	0.1	0.1	0.094	0.094	0.1	0.117
	RPM	1023	796	707	637	651	573	512	424	398	354	318
7	Vc	35	35	30	35	35	35	35	30	30	35	30
	fz	0.069	0.077	0.091	0.091	0.1	0.094	0.094	0.1	0.108	0.092	0.11
	RPM	796	696	531	557	506	446	398	371	298	309	239
8-9	Vc	20	20	20	20	20	20	20	20	20	15	20
	fz	0.07	0.081	0.093	0.108	0.108	0.1	0.1	0.1	0.1	0.117	0.117
	RPM	455	398	354	318	289	255	227	199	133	159	159
10	Vc	45	40	40	40	45	45	45	40	40	40	40
	fz	0.063	0.078	0.089	0.096	0.096	0.1	0.1	0.094	0.094	0.1	0.117
	RPM	1023	796	707	637	651	573	512	424	398	354	318
11.1	Vc	20	20	20	20	20	20	20	20	20	15	20
	fz	0.07	0.081	0.093	0.108	0.108	0.1	0.1	0.1	0.1	0.117	0.117
	RPM	455	398	354	318	289	255	227	199	133	159	159
21-22	Vc	135	140	140	140	135	135	135	145	140	140	140
	fz	0.079	0.088	0.098	0.1	0.108	0.115	0.123	0.123	0.12	0.124	0.127
	RPM	3069	2785	2476	2228	1953	1719	1535	1538	1393	1238	1114
23-24	Vc	88	91	91	91	88	88	88	94	91	91	91
	fz	0.079	0.088	0.098	0.1	0.108	0.115	0.123	0.123	0.12	0.124	0.127
	RPM	2001	1810	1609	1448	1273	1120	1000	997	905	805	724

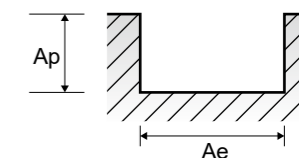



RECOMMENDED CUTTING CONDITIONS
EMPFOLHENE SCHNEIDPARAMETER

E2572, E2573, E2516, E2553, E2554 SERIES **3 FLUTE - SLOTTING**

Vc = m/min.
fz = mm/tooth
RPM = rev./min.
FEED = mm/min.

ISO	VDI 3323	Material Description	Ae	Ap	Parameter	Diameter (Ø)							
						2.0	3.0	4.0	5.0	6.0	8.0	10.0	12.0
P	1	Non-alloy steel	1.0D	0.5D	Vc	35	35	35	35	35	35	35	35
					fz	0.002	0.005	0.007	0.012	0.015	0.021	0.027	0.037
					RPM	5570	3714	2785	2228	1857	1393	1114	928
	2		1.0D	0.5D	Vc	30	30	30	30	30	30	30	30
					fz	0.002	0.004	0.007	0.01	0.014	0.021	0.026	0.033
					RPM	4775	3183	2387	1910	1592	1194	955	796
	3-4		1.0D	0.5D	Vc	25	25	25	25	25	25	25	25
					fz	0.002	0.003	0.006	0.008	0.011	0.019	0.023	0.029
					RPM	3979	2653	1989	1592	1326	995	796	663
	5		1.0D	0.5D	Vc	15	15	15	15	15	15	15	15
					fz	0.002	0.003	0.006	0.007	0.01	0.018	0.022	0.029
RPM		2387			1592	1194	955	796	597	477	398		
6	1.0D	0.5D	Vc	30	30	30	30	30	30	30	30		
			fz	0.002	0.004	0.007	0.01	0.014	0.021	0.026	0.033		
			RPM	4775	3183	2387	1910	1592	1194	955	796		
7	1.0D	0.5D	Vc	25	25	25	25	25	25	25	25		
			fz	0.002	0.003	0.006	0.008	0.011	0.019	0.023	0.029		
			RPM	3979	2653	1989	1592	1326	995	796	663		
8-9	1.0D	0.5D	Vc	15	15	15	15	15	15	15	15		
			fz	0.002	0.003	0.006	0.007	0.01	0.018	0.022	0.029		
			RPM	2387	1592	1194	955	796	597	477	398		
10	1.0D	0.5D	Vc	30	30	30	30	30	30	30	30		
			fz	0.002	0.004	0.007	0.01	0.014	0.021	0.026	0.033		
			RPM	4775	3183	2387	1910	1592	1194	955	796		
11.1	1.0D	0.5D	Vc	15	15	15	15	15	15	15	15		
			fz	0.002	0.003	0.006	0.007	0.01	0.018	0.022	0.029		
			RPM	2387	1592	1194	955	796	597	477	398		
N	21-22	Aluminum-wrought alloy	1.0D	0.5D	Vc	75	105	100	100	105	100	95	95
					fz	0.003	0.005	0.008	0.011	0.013	0.022	0.029	0.035
					RPM	11937	11141	7958	6366	5570	3979	3024	2520
23-24	Aluminum-cast, alloyed	1.0D	0.5D	Vc	49	68	65	65	68	65	62	62	
				fz	0.003	0.005	0.008	0.011	0.013	0.022	0.029	0.035	
				RPM	7799	7215	5173	4138	3608	2586	1974	1645	

※The FEED, in long & extra long types, should be reduced by around 50%

▶ NEXT PAGE

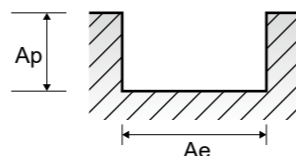

RECOMMENDED CUTTING CONDITIONS
EMPFOLHENE SCHNEIDPARAMETER

E2572, E2573, E2516, E2553, E2554 SERIES **3 FLUTE - SLOTTING**

Vc = m/min.
fz = mm/tooth
RPM = rev./min.
FEED = mm/min.

VDI 3323	Parameter	Diameter (Ø)											
		14.0	16.0	18.0	20.0	22.0	25.0	28.0	30.0	32.0	35.0	36.0	40.0
1	Vc	35	35	35	35	35	35	35	35	35	35	35	35
	fz	0.042	0.048	0.048	0.054	0.06	0.059	0.058	0.057	0.057	0.057	0.059	0.065
	RPM	796	696	619	557	506	446	398	371	348	318	309	279
2	Vc	30	30	30	30	30	30	30	30	30	30	30	30
	fz	0.033	0.042	0.047	0.052	0.052	0.054	0.052	0.054	0.054	0.051	0.053	0.061
	RPM	682	597	531	477	434	382	341	318	298	273	265	239
3-4	Vc	25	25	25	25	25	25	25	25	25	25	25	25
	fz	0.033	0.037	0.042	0.042	0.048	0.043	0.042	0.04	0.045	0.04	0.042	0.046
	RPM	568	497	442	398	362	318	284	265	199	227	221	199
5	Vc	15	15	15	15	15	15	15	15	15	15	15	15
	fz	0.033	0.036	0.04	0.045	0.045	0.037	0.042	0.042	0.048	0.038	0.042	0.045
	RPM	341	298	265	239	217	191	171	159	149	136	133	119
6	Vc	30	30	30	30	30	30	30	30	30	30	30	30
	fz	0.033	0.042	0.047	0.052	0.052	0.054	0.052	0.054	0.054	0.051	0.053	0.061
	RPM	682	597	531	477	434	382	341	318	298	273	265	239
7	Vc	25	25	25	25	25	25	25	25	25	25	25	25
	fz	0.033	0.037	0.042	0.042	0.048	0.043	0.042	0.04	0.045	0.04	0.042	0.046
	RPM	568	497	442	398	362	318	284	265	199	227	221	199
8-9	Vc	15	15	15	15	15	15	15	15	15	15	15	15
	fz	0.033	0.036	0.04	0.045	0.045	0.037	0.042	0.042	0.048	0.038	0.042	0.045
	RPM	341	298	265	239	217	191	171	159	149	136	133	119
10	Vc	30	30	30	30	30	30	30	30	30	30	30	30
	fz	0.033	0.042	0.047	0.052	0.052	0.054	0.052	0.054	0.054	0.051	0.053	0.061
	RPM	682	597	531	477	434	382	341	318	298	273	265	239
11.1	Vc	15	15	15	15	15	15	15	15	15	15	15	15
	fz	0.033	0.036	0.04	0.045	0.045	0.037	0.042	0.042	0.048	0.038	0.042	0.045
	RPM	341	298	265	239	217	191	171	159	149	136	133	119
21-22	Vc	95	100	100	100	95	95	95	105	100	105	100	100
	fz	0.036	0.04	0.044	0.046	0.048	0.053	0.055	0.055	0.053	0.053	0.056	0.054
	RPM	2160	1989	1768	1592	1375	1210	1080	1114	995	955	884	796
23-24	Vc	62	65	65	65	62	62	62	68	65	68	65	65
	fz	0.036	0.04	0.044	0.046	0.048	0.053	0.055	0.055	0.053	0.053	0.056	0.054
	RPM	1410	1293	1149	1035	897	789	705	722	647	618	575	517

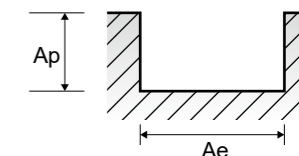



RECOMMENDED CUTTING CONDITIONS
EMPFOHLENE SCHNEIDPARAMETER

E2572, E2573, E2516, E2553, E2554 SERIES 3 FLUTE - SIDE CUTTING

Vc = m/min.
fz = mm/tooth
RPM = rev./min.
FEED = mm/min.

ISO	VDI 3323	Material Description	Ae	Ap	Parameter	Diameter (Ø)							
						2.0	3.0	4.0	5.0	6.0	8.0	10.0	12.0
P	1	Non-alloy steel	0.1D	1.5D	Vc	35	35	35	35	35	35	35	35
					fz	0.004	0.008	0.013	0.02	0.025	0.036	0.045	0.061
					RPM	5570	3714	2785	2228	1857	1393	1114	928
	2		0.1D	1.5D	Vc	30	30	30	30	30	30	30	30
					fz	0.003	0.006	0.011	0.018	0.023	0.036	0.044	0.056
					RPM	4775	3183	2387	1910	1592	1194	955	796
	3-4		0.1D	1.5D	Vc	25	25	25	25	25	25	25	25
					fz	0.003	0.006	0.009	0.014	0.018	0.03	0.038	0.048
					RPM	3979	2653	1989	1592	1326	995	796	663
	5		0.1D	1.5D	Vc	15	15	15	15	15	15	15	15
					fz	0.002	0.004	0.009	0.013	0.019	0.03	0.037	0.046
RPM		2387			1592	1194	955	796	597	477	398		
6	0.1D	1.5D	Vc	30	30	30	30	30	30	30	30		
			fz	0.003	0.006	0.011	0.018	0.023	0.036	0.044	0.056		
			RPM	4775	3183	2387	1910	1592	1194	955	796		
7	0.1D	1.5D	Vc	25	25	25	25	25	25	25	25		
			fz	0.003	0.006	0.009	0.014	0.018	0.03	0.038	0.048		
			RPM	3979	2653	1989	1592	1326	995	796	663		
8-9	0.1D	1.5D	Vc	15	15	15	15	15	15	15	15		
			fz	0.002	0.004	0.009	0.013	0.019	0.03	0.037	0.046		
			RPM	2387	1592	1194	955	796	597	477	398		
10	0.1D	1.5D	Vc	30	30	30	30	30	30	30	30		
			fz	0.003	0.006	0.011	0.018	0.023	0.036	0.044	0.056		
			RPM	4775	3183	2387	1910	1592	1194	955	796		
11.1	0.1D	1.5D	Vc	15	15	15	15	15	15	15	15		
			fz	0.002	0.004	0.009	0.013	0.019	0.03	0.037	0.046		
			RPM	2387	1592	1194	955	796	597	477	398		
N	21-22	Aluminum-wrought alloy	0.1D	1.5D	Vc	75	105	100	100	105	100	95	95
					fz	0.005	0.008	0.014	0.019	0.021	0.037	0.048	0.057
					RPM	11937	11141	7958	6366	5570	3979	3024	2520
23-24	Aluminum-cast, alloyed	0.1D	1.5D	Vc	49	68	65	65	68	65	62	62	
				fz	0.005	0.008	0.014	0.019	0.021	0.037	0.048	0.057	
				RPM	7799	7215	5173	4138	3608	2586	1974	1645	

※The FEED, in long & extra long types, should be reduced by around 50%

▶ NEXT PAGE

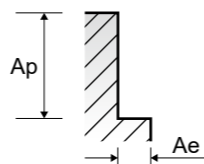

RECOMMENDED CUTTING CONDITIONS
EMPFOHLENE SCHNEIDPARAMETER

E2572, E2573, E2516, E2553, E2554 SERIES 3 FLUTE - SIDE CUTTING

Vc = m/min.
fz = mm/tooth
RPM = rev./min.
FEED = mm/min.

VDI 3323	Parameter	Diameter (Ø)											
		14.0	16.0	18.0	20.0	22.0	25.0	28.0	30.0	32.0	35.0	36.0	40.0
1	Vc	35	35	35	35	35	35	35	35	35	35	35	35
	fz	0.069	0.079	0.079	0.089	0.1	0.1	0.1	0.1	0.1	0.099	0.097	0.107
	RPM	796	696	619	557	506	446	398	371	348	318	309	279
2	Vc	30	30	30	30	30	30	30	30	30	30	30	30
	fz	0.057	0.071	0.08	0.089	0.089	0.092	0.09	0.086	0.089	0.083	0.087	0.098
	RPM	682	597	531	477	434	382	341	318	298	273	265	239
3-4	Vc	25	25	25	25	25	25	25	25	25	25	25	25
	fz	0.054	0.059	0.067	0.067	0.076	0.076	0.071	0.073	0.076	0.071	0.075	0.083
	RPM	568	497	442	398	362	318	284	265	199	227	221	199
5	Vc	15	15	15	15	15	15	15	15	15	15	15	15
	fz	0.052	0.06	0.067	0.076	0.076	0.065	0.063	0.063	0.071	0.064	0.069	0.076
	RPM	341	298	265	239	217	191	171	159	149	136	133	119
6	Vc	30	30	30	30	30	30	30	30	30	30	30	30
	fz	0.057	0.071	0.08	0.089	0.089	0.092	0.09	0.086	0.089	0.083	0.087	0.098
	RPM	682	597	531	477	434	382	341	318	298	273	265	239
7	Vc	25	25	25	25	25	25	25	25	25	25	25	25
	fz	0.054	0.059	0.067	0.067	0.076	0.076	0.071	0.073	0.076	0.071	0.075	0.083
	RPM	568	497	442	398	362	318	284	265	199	227	221	199
8-9	Vc	15	15	15	15	15	15	15	15	15	15	15	15
	fz	0.052	0.06	0.067	0.076	0.076	0.065	0.063	0.063	0.071	0.064	0.069	0.076
	RPM	341	298	265	239	217	191	171	159	149	136	133	119
10	Vc	30	30	30	30	30	30	30	30	30	30	30	30
	fz	0.057	0.071	0.08	0.089	0.089	0.092	0.09	0.086	0.089	0.083	0.087	0.098
	RPM	682	597	531	477	434	382	341	318	298	273	265	239
11.1	Vc	15	15	15	15	15	15	15	15	15	15	15	15
	fz	0.052	0.06	0.067	0.076	0.076	0.065	0.063	0.063	0.071	0.064	0.069	0.076
	RPM	341	298	265	239	217	191	171	159	149	136	133	119
21-22	Vc	95	100	100	100	95	95	95	95	105	100	100	100
	fz	0.061	0.067	0.074	0.075	0.081	0.089	0.091	0.091	0.09	0.091	0.093	0.092
	RPM	2160	1989	1768	1592	1375	1210	1080	1114	995	955	884	796
23-24	Vc	62	65	65	65	62	62	62	62	68	65	65	65
	fz	0.061	0.067	0.074	0.075	0.081	0.089	0.091	0.091	0.09	0.091	0.093	0.092
	RPM	1410	1293	1149	1035	897	789	705	722	647	618	575	517

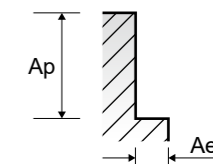

EQ572, EQ573, EQ516, EQ553, EQ554 SERIES

3 FLUTE TiAlN COATED - SLOTTING

Vc = m/min.
fz = mm/tooth
RPM = rev./min.
FEED = mm/min.

ISO	VDI 3323	Material Description	Ae	Ap	Parameter	Diameter (Ø)							
						2.0	3.0	4.0	5.0	6.0	8.0	10.0	12.0
P	1	Non-alloy steel	1.0D	0.5D	Vc	50	45	50	50	45	50	45	50
					fz	0.002	0.005	0.007	0.012	0.015	0.021	0.028	0.036
					RPM	7958	4775	3979	3183	2387	1989	1432	1326
	2		Vc	40	40	40	40	40	40	40	40		
			fz	0.002	0.004	0.006	0.01	0.014	0.022	0.028	0.033		
			RPM	6366	4244	3183	2546	2122	1592	1273	1061		
	3-4		Vc	35	35	30	35	30	35	35	35		
			fz	0.002	0.003	0.005	0.008	0.011	0.018	0.023	0.028		
			RPM	5570	3714	2387	2228	1592	1393	1114	928		
	5		Vc	20	20	20	20	20	20	20	20		
			fz	0.002	0.003	0.007	0.008	0.011	0.017	0.021	0.03		
RPM		3183	2122	1592	1273	1061	796	637	531				
6	Vc	40	40	40	40	40	40	40	40				
	fz	0.002	0.004	0.006	0.01	0.014	0.022	0.028	0.033				
	RPM	6366	4244	3183	2546	2122	1592	1273	1061				
7	Vc	35	35	30	35	30	35	35	35				
	fz	0.002	0.003	0.005	0.008	0.011	0.018	0.023	0.028				
	RPM	5570	3714	2387	2228	1592	1393	1114	928				
8-9	Vc	20	20	20	20	20	20	20	20				
	fz	0.002	0.003	0.007	0.008	0.011	0.017	0.021	0.03				
	RPM	3183	2122	1592	1273	1061	796	637	531				
10	Vc	40	40	40	40	40	40	40	40				
	fz	0.002	0.004	0.006	0.01	0.014	0.022	0.028	0.033				
	RPM	6366	4244	3183	2546	2122	1592	1273	1061				
11.1	Vc	20	20	20	20	20	20	20	20				
	fz	0.002	0.003	0.007	0.008	0.011	0.017	0.021	0.03				
	RPM	3183	2122	1592	1273	1061	796	637	531				
N	21-22	Aluminum-wrought alloy	1.0D	0.5D	Vc	105	145	140	140	145	140	135	130
					fz	0.003	0.005	0.008	0.011	0.012	0.021	0.029	0.034
					RPM	16711	15385	11141	8913	7692	5570	4297	3448
23-24	Aluminum-cast, alloyed	1.0D	0.5D	Vc	68	94	91	91	94	91	88	85	
				fz	0.003	0.005	0.008	0.011	0.012	0.021	0.029	0.034	
				RPM	10823	9974	7242	5793	4987	3621	2801	2255	

※The FEED, in long & extra long types, should be reduced by around 50%

▶ NEXT PAGE

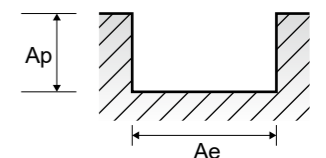
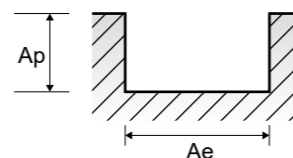

EQ572, EQ573, EQ516, EQ553, EQ554 SERIES

3 FLUTE TiAlN COATED - SLOTTING

Vc = m/min.
fz = mm/tooth
RPM = rev./min.
FEED = mm/min.

VDI 3323	Parameter	Diameter (Ø)											
		14.0	16.0	18.0	20.0	22.0	25.0	28.0	30.0	32.0	35.0	36.0	40.0
1	Vc	50	50	50	50	50	50	50	45	50	50	50	50
	fz	0.042	0.048	0.047	0.053	0.06	0.058	0.06	0.058	0.059	0.058	0.064	0.064
	RPM	1137	995	884	796	723	637	568	477	497	455	442	398
2	Vc	45	40	40	40	45	45	40	40	40	40	40	40
	fz	0.034	0.043	0.048	0.053	0.053	0.054	0.051	0.054	0.056	0.056	0.052	0.059
	RPM	1023	796	707	637	651	573	512	424	398	364	354	318
3-4	Vc	35	30	30	35	35	35	35	30	30	30	30	30
	fz	0.032	0.037	0.042	0.042	0.048	0.043	0.043	0.038	0.043	0.04	0.042	0.047
	RPM	796	597	531	557	506	446	398	371	298	273	265	239
5	Vc	20	20	20	20	20	20	20	20	20	20	20	20
	fz	0.034	0.034	0.038	0.043	0.043	0.04	0.045	0.045	0.05	0.046	0.039	0.044
	RPM	455	398	354	318	289	255	227	212	199	182	177	159
6	Vc	45	40	40	40	45	45	40	40	40	40	40	40
	fz	0.034	0.043	0.048	0.053	0.053	0.054	0.051	0.054	0.056	0.056	0.052	0.059
	RPM	1023	796	707	637	651	573	512	424	398	364	354	318
7	Vc	35	30	30	35	35	35	35	30	30	30	30	30
	fz	0.032	0.037	0.042	0.042	0.048	0.043	0.043	0.038	0.043	0.04	0.042	0.047
	RPM	796	597	531	557	506	446	398	371	298	273	265	239
8-9	Vc	20	20	20	20	20	20	20	20	20	20	20	20
	fz	0.034	0.034	0.038	0.043	0.043	0.04	0.045	0.045	0.05	0.046	0.039	0.044
	RPM	455	398	354	318	289	255	227	212	199	182	177	159
10	Vc	45	40	40	40	45	45	40	40	40	40	40	40
	fz	0.034	0.043	0.048	0.053	0.053	0.054	0.051	0.054	0.056	0.056	0.052	0.059
	RPM	1023	796	707	637	651	573	512	424	398	364	354	318
11.1	Vc	20	20	20	20	20	20	20	20	20	20	20	20
	fz	0.034	0.034	0.038	0.043	0.043	0.04	0.045	0.045	0.05	0.046	0.039	0.044
	RPM	455	398	354	318	289	255	227	212	199	182	177	159
21-22	Vc	135	140	140	140	135	135	130	140	140	145	140	140
	fz	0.037	0.04	0.045	0.047	0.048	0.053	0.056	0.054	0.055	0.055	0.056	0.055
	RPM	3069	2785	2476	2228	1953	1719	1478	1485	1393	1319	1238	1114
23-24	Vc	88	91	91	91	88	88	85	91	91	94	91	91
	fz	0.037	0.04	0.045	0.047	0.048	0.053	0.056	0.056	0.054	0.055	0.056	0.055
	RPM	2001	1810	1609	1448	1273	1120	966	966	905	855	805	724

EQ572, EQ573, EQ516, EQ553, EQ554 SERIES

3 FLUTE TiAlN COATED - SIDE CUTTING

Vc = m/min.
fz = mm/tooth
RPM = rev./min.
FEED = mm/min.

ISO	VDI 3323	Material Description	Ae	Ap	Parameter	Diameter (Ø)							
						2.0	3.0	4.0	5.0	6.0	8.0	10.0	12.0
P	1	Non-alloy steel	0.1D	1.5D	Vc	50	45	50	50	45	50	45	50
					fz	0.004	0.007	0.012	0.02	0.025	0.035	0.047	0.059
					RPM	7958	4775	3979	3183	2387	1989	1432	1326
	2		Vc	40	40	40	40	40	40	40	40		
			fz	0.003	0.006	0.011	0.017	0.023	0.038	0.044	0.058		
			RPM	6366	4244	3183	2546	2122	1592	1273	1061		
	3-4		Vc	35	35	30	35	30	35	35	35		
			fz	0.003	0.006	0.009	0.014	0.018	0.028	0.038	0.047		
			RPM	5570	3714	2387	2228	1592	1393	1114	928		
	5		Vc	20	20	20	20	20	20	20	20		
			fz	0.002	0.005	0.009	0.013	0.018	0.03	0.037	0.045		
RPM		3183	2122	1592	1273	1061	796	637	531				
6	Vc	40	40	40	40	40	40	40	40				
	fz	0.003	0.006	0.011	0.017	0.023	0.038	0.044	0.058				
	RPM	6366	4244	3183	2546	2122	1592	1273	1061				
7	Vc	35	35	30	35	30	35	35	35				
	fz	0.003	0.006	0.009	0.014	0.018	0.028	0.038	0.047				
	RPM	5570	3714	2387	2228	1592	1393	1114	928				
8-9	Vc	20	20	20	20	20	20	20	20				
	fz	0.002	0.005	0.009	0.013	0.018	0.03	0.037	0.045				
	RPM	3183	2122	1592	1273	1061	796	637	531				
10	Vc	40	40	40	40	40	40	40	40				
	fz	0.003	0.006	0.011	0.017	0.023	0.038	0.044	0.058				
	RPM	6366	4244	3183	2546	2122	1592	1273	1061				
11.1	Vc	20	20	20	20	20	20	20	20				
	fz	0.002	0.005	0.009	0.013	0.018	0.03	0.037	0.045				
	RPM	3183	2122	1592	1273	1061	796	637	531				
N	21-22	Aluminum-wrought alloy	0.1D	1.5D	Vc	105	145	140	140	145	140	135	130
					fz	0.005	0.008	0.014	0.019	0.021	0.037	0.049	0.057
					RPM	16711	15385	11141	8913	7692	5570	4297	3448
23-24	Aluminum-cast, alloyed	0.1D	1.5D	Vc	68	94	91	91	94	91	88	85	
				fz	0.005	0.008	0.014	0.019	0.021	0.037	0.049	0.057	
				RPM	10823	9974	7242	5793	4987	3621	2801	2255	

※The FEED, in long & extra long types, should be reduced by around 50%

▶ NEXT PAGE

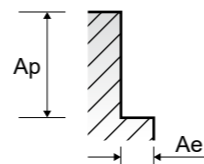

EQ572, EQ573, EQ516, EQ553, EQ554 SERIES

3 FLUTE TiAlN COATED - SIDE CUTTING

Vc = m/min.
fz = mm/tooth
RPM = rev./min.
FEED = mm/min.

VDI 3323	Parameter	Diameter (Ø)											
		14.0	16.0	18.0	20.0	22.0	25.0	28.0	30.0	32.0	35.0	36.0	40.0
1	Vc	50	50	50	50	50	50	50	45	50	50	50	50
	fz	0.07	0.078	0.08	0.09	0.1	0.101	0.101	0.099	0.099	0.096	0.097	0.107
	RPM	1137	995	884	796	723	637	568	477	497	455	442	398
2	Vc	45	40	40	40	45	45	40	40	40	40	40	40
	fz	0.058	0.073	0.081	0.09	0.09	0.092	0.088	0.085	0.09	0.088	0.086	0.097
	RPM	1023	796	707	637	651	573	512	424	398	364	354	318
3-4	Vc	35	30	30	35	35	35	35	30	30	30	30	30
	fz	0.053	0.058	0.065	0.065	0.075	0.07	0.073	0.071	0.075	0.075	0.077	0.087
	RPM	796	597	531	557	506	446	398	371	298	273	265	239
5	Vc	20	20	20	20	20	20	20	20	20	20	20	20
	fz	0.051	0.06	0.067	0.075	0.075	0.067	0.061	0.061	0.067	0.065	0.069	0.078
	RPM	455	398	354	318	289	255	227	212	199	182	177	159
6	Vc	45	40	40	40	45	45	40	40	40	40	40	40
	fz	0.058	0.073	0.081	0.09	0.09	0.092	0.088	0.085	0.09	0.088	0.086	0.097
	RPM	1023	796	707	637	651	573	512	424	398	364	354	318
7	Vc	35	30	30	35	35	35	35	30	30	30	30	30
	fz	0.053	0.058	0.065	0.065	0.075	0.07	0.073	0.071	0.075	0.075	0.077	0.087
	RPM	796	597	531	557	506	446	398	371	298	273	265	239
8-9	Vc	20	20	20	20	20	20	20	20	20	20	20	20
	fz	0.051	0.06	0.067	0.075	0.075	0.067	0.061	0.061	0.067	0.065	0.069	0.078
	RPM	455	398	354	318	289	255	227	212	199	182	177	159
10	Vc	45	40	40	40	45	45	40	40	40	40	40	40
	fz	0.058	0.073	0.081	0.09	0.09	0.092	0.088	0.085	0.09	0.088	0.086	0.097
	RPM	1023	796	707	637	651	573	512	424	398	364	354	318
11.1	Vc	20	20	20	20	20	20	20	20	20	20	20	20
	fz	0.051	0.06	0.067	0.075	0.075	0.067	0.061	0.061	0.067	0.065	0.069	0.078
	RPM	455	398	354	318	289	255	227	212	199	182	177	159
21-22	Vc	135	140	140	140	135	135	130	140	140	145	140	140
	fz	0.06	0.067	0.075	0.076	0.082	0.088	0.093	0.09	0.092	0.093	0.093	0.094
	RPM	3069	2785	2476	2228	1953	1719	1478	1485	1393	1319	1238	1114
23-24	Vc	88	91	91	91	88	88	85	91	91	94	91	91
	fz	0.06	0.067	0.075	0.076	0.082	0.088	0.093	0.093	0.09	0.092	0.093	0.094
	RPM	2001	1810	1609	1448	1273	1120	966	966	905	855	805	724

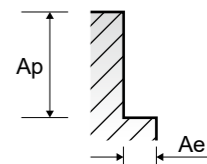



RECOMMENDED CUTTING CONDITIONS
EMPFOHLENE SCHNEIDPARAMETER

E2574, E2597 SERIES 4 FLUTE - SIDE CUTTING

Vc = m/min.
fz = mm/tooth
RPM = rev./min.
FEED = mm/min.

Table with columns: ISO, VDI 3323, Material Description, Ae, Ap, Parameter, Diameter (Ø) [2.0, 3.0, 4.0, 5.0, 6.0, 8.0, 10.0]. Rows include ISO P (1-11.1) for Non-alloy steel, Low alloy steel, and High alloyed steel, tool steel; and ISO N (21-22, 23-24) for Aluminum-wrought alloy and Aluminum-cast, alloyed.

※The FEED, in long & extra long types, should be reduced by around 50%

▶ NEXT PAGE

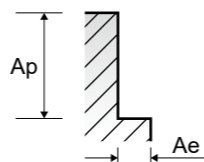

RECOMMENDED CUTTING CONDITIONS
EMPFOHLENE SCHNEIDPARAMETER

E2574, E2597 SERIES 4 FLUTE - SIDE CUTTING

Vc = m/min.
fz = mm/tooth
RPM = rev./min.
FEED = mm/min.

Table with columns: VDI 3323, Parameter, Diameter (Ø) [12.0, 14.0, 16.0, 18.0, 20.0, 22.0, 25.0, 28.0, 30.0, 32.0, 36.0, 40.0]. Rows include VDI 3323 (1-11.1, 21-22, 23-24) for various materials.

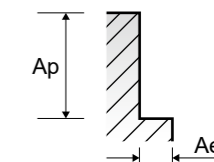



RECOMMENDED CUTTING CONDITIONS
EMPFOHLENE SCHNEIDPARAMETER

EQ574, EQ597 SERIES 4 FLUTE TiAlN COATED - **SIDE CUTTING**

Vc = m/min.
fz = mm/tooth
RPM = rev./min.
FEED = mm/min.

ISO	VDI 3323	Material Description	Ae	Ap	Parameter	Diameter (Ø)							
						2.0	3.0	4.0	5.0	6.0	8.0	10.0	12.0
P	1	Non-alloy steel	0.1D	1.5D	Vc	50	45	50	50	45	50	50	45
					fz	0.004	0.008	0.013	0.02	0.025	0.036	0.045	0.062
					RPM	7958	4775	3979	3183	2387	1989	1592	1194
	2		0.1D	1.5D	Vc	40	40	40	40	40	40	40	40
					fz	0.003	0.006	0.011	0.018	0.023	0.036	0.045	0.057
					RPM	6366	4244	3183	2546	2122	1592	1273	1061
	3-4		0.1D	1.5D	Vc	35	35	30	35	30	35	35	35
					fz	0.003	0.006	0.009	0.014	0.018	0.029	0.039	0.047
					RPM	5570	3714	2387	2228	1592	1194	1114	928
	5		0.1D	1.5D	Vc	20	20	20	20	20	20	20	20
					fz	0.002	0.004	0.01	0.014	0.019	0.028	0.035	0.048
RPM		3183			2122	1592	1273	1061	796	637	531		
6	0.1D	1.5D	Vc	40	40	40	40	40	40	40	40		
			fz	0.003	0.006	0.011	0.018	0.023	0.036	0.045	0.057		
			RPM	6366	4244	3183	2546	2122	1592	1273	1061		
7	0.1D	1.5D	Vc	35	35	30	35	30	35	35	35		
			fz	0.003	0.006	0.009	0.014	0.018	0.029	0.039	0.047		
			RPM	5570	3714	2387	2228	1592	1194	1114	928		
8-9	0.1D	1.5D	Vc	20	20	20	20	20	20	20	20		
			fz	0.002	0.004	0.01	0.014	0.019	0.028	0.035	0.048		
			RPM	3183	2122	1592	1273	1061	796	637	531		
10	0.1D	1.5D	Vc	40	40	40	40	40	40	40	40		
			fz	0.003	0.006	0.011	0.018	0.023	0.036	0.045	0.057		
			RPM	6366	4244	3183	2546	2122	1592	1273	1061		
11.1	0.1D	1.5D	Vc	20	20	20	20	20	20	20	20		
			fz	0.002	0.004	0.01	0.014	0.019	0.028	0.035	0.048		
			RPM	3183	2122	1592	1273	1061	796	637	531		
21-22	0.1D	1.5D	Vc	105	145	140	140	150	140	135	130		
			fz	0.005	0.009	0.014	0.019	0.021	0.036	0.048	0.057		
			RPM	16711	15385	11141	8913	7958	5570	4297	3448		
23-24	0.1D	1.5D	Vc	68	94	91	91	98	91	88	85		
			fz	0.005	0.009	0.014	0.019	0.021	0.036	0.048	0.057		
			RPM	10823	9974	7242	5793	5199	3621	2801	2255		
FEED						216	359	406	440	437	521	538	514

※ The FEED, in long & extra long types, should be reduced by around 50%

▶ NEXT PAGE

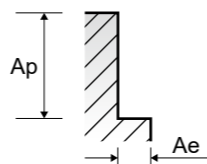

RECOMMENDED CUTTING CONDITIONS
EMPFOHLENE SCHNEIDPARAMETER

EQ574, EQ597 SERIES 4 FLUTE TiAlN COATED - **SIDE CUTTING**

Vc = m/min.
fz = mm/tooth
RPM = rev./min.
FEED = mm/min.

VDI 3323	Parameter	Diameter (Ø)											
		14.0	16.0	18.0	20.0	22.0	25.0	28.0	30.0	32.0	36.0	40.0	
1	Vc	50	50	50	50	50	50	50	45	50	50	50	
	fz	0.07	0.078	0.078	0.088	0.067	0.064	0.068	0.065	0.065	0.063	0.071	
	RPM	1137	995	884	796	723	637	568	477	497	442	398	
2	Vc	45	40	40	40	45	45	45	40	40	40	40	
	fz	0.056	0.07	0.08	0.087	0.058	0.062	0.058	0.057	0.058	0.06	0.069	
	RPM	1023	796	707	637	651	573	512	424	398	354	318	
3-4	Vc	35	35	30	35	35	35	35	30	35	35	30	
	fz	0.053	0.056	0.066	0.066	0.048	0.046	0.046	0.05	0.05	0.047	0.057	
	RPM	796	696	531	557	506	446	398	371	298	309	239	
5	Vc	20	20	20	20	20	20	20	20	20	15	20	
	fz	0.053	0.056	0.064	0.075	0.05	0.047	0.054	0.054	0.054	0.056	0.056	
	RPM	455	398	354	318	289	255	227	212	199	133	159	
6	Vc	45	40	40	40	45	45	45	40	40	40	40	
	fz	0.056	0.07	0.08	0.087	0.058	0.062	0.058	0.057	0.058	0.06	0.069	
	RPM	1023	796	707	637	651	573	512	424	398	354	318	
7	Vc	35	35	30	35	35	35	35	35	30	35	30	
	fz	0.053	0.056	0.066	0.066	0.048	0.046	0.046	0.05	0.05	0.047	0.057	
	RPM	796	696	531	557	506	446	398	371	298	309	239	
8-9	Vc	20	20	20	20	20	20	20	20	20	15	20	
	fz	0.053	0.056	0.064	0.075	0.05	0.047	0.054	0.054	0.054	0.056	0.056	
	RPM	455	398	354	318	289	255	227	212	199	133	159	
10	Vc	45	40	40	40	45	45	45	40	40	40	40	
	fz	0.056	0.07	0.08	0.087	0.058	0.062	0.058	0.057	0.058	0.06	0.069	
	RPM	1023	796	707	637	651	573	512	424	398	354	318	
11.1	Vc	20	20	20	20	20	20	20	20	20	15	20	
	fz	0.053	0.056	0.064	0.075	0.05	0.047	0.054	0.054	0.054	0.056	0.056	
	RPM	455	398	354	318	289	255	227	212	199	133	159	
21-22	Vc	135	140	140	140	135	135	135	145	140	140	140	
	fz	0.06	0.066	0.074	0.074	0.054	0.058	0.06	0.06	0.06	0.061	0.064	
	RPM	3069	2785	2476	2228	1953	1719	1535	1538	1393	1238	1114	
23-24	Vc	88	91	91	91	88	88	88	94	91	91	91	
	fz	0.06	0.066	0.074	0.074	0.054	0.058	0.06	0.06	0.06	0.061	0.064	
	RPM	2001	1810	1609	1448	1273	1120	1000	997	905	805	724	
FEED		480	478	476	429	413	390	360	359	326	294	278	

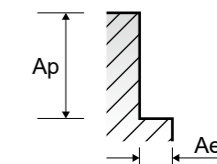

E2753, E2762, E2751, E2752 SERIES

MULTI FLUTE ROUGHING - SIDE CUTTING

Vc = m/min.
fz = mm/tooth
RPM = rev./min.
FEED = mm/min.

ISO	VDI 3323	Material Description	Ae	Ap	Parameter	Diameter (Ø)					
						6.0	8.0	10.0	12.0	14.0	16.0
P	1	Non-alloy steel	0.5D	1.5D	Vc	35	35	35	35	35	35
					fz	0.015	0.025	0.034	0.05	0.056	0.064
					RPM	1857	1393	1114	928	796	696
	2		0.5D	1.5D	Vc	30	30	30	30	30	30
					fz	0.013	0.023	0.033	0.044	0.05	0.063
					RPM	1592	1194	955	796	682	597
	3-4		0.5D	1.5D	Vc	25	25	25	25	25	25
					fz	0.015	0.024	0.034	0.044	0.049	0.061
					RPM	1326	995	796	663	568	497
	5		0.5D	1.5D	Vc	15	15	15	15	15	15
					fz	0.013	0.021	0.033	0.044	0.05	0.063
RPM		796			597	477	398	341	298		
6	0.5D	1.5D	Vc	30	30	30	30	30	30		
			fz	0.013	0.023	0.033	0.044	0.05	0.063		
			RPM	1592	1194	955	796	682	597		
7	0.5D	1.5D	Vc	25	25	25	25	25	25		
			fz	0.015	0.024	0.034	0.044	0.049	0.061		
			RPM	1326	995	796	663	568	497		
8-9	0.5D	1.5D	Vc	15	15	15	15	15	15		
			fz	0.013	0.021	0.033	0.044	0.05	0.063		
			RPM	796	597	477	398	341	298		
10	0.5D	1.5D	Vc	30	30	30	30	30	30		
			fz	0.013	0.023	0.033	0.044	0.05	0.063		
			RPM	1592	1194	955	796	682	597		
11.1	0.5D	1.5D	Vc	15	15	15	15	15	15		
			fz	0.013	0.021	0.033	0.044	0.05	0.063		
			RPM	796	597	477	398	341	298		
21-22	0.5D	1.5D	Vc	85	80	80	75	80	80		
			fz	0.015	0.025	0.035	0.05	0.058	0.07		
			RPM	4509	3183	2546	1989	1819	1592		
23-24	0.5D	1.5D	Vc	55	52	52	49	52	52		
			fz	0.015	0.025	0.035	0.05	0.058	0.07		
			RPM	2918	2069	1655	1300	1182	1035		

※ The FEED, in long & extra long types, should be reduced by around 50%

▶ NEXT PAGE

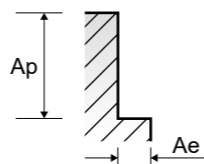

E2753, E2762, E2751, E2752 SERIES

MULTI FLUTE ROUGHING - SIDE CUTTING

Vc = m/min.
fz = mm/tooth
RPM = rev./min.
FEED = mm/min.

VDI 3323	Parameter	Diameter (Ø)									
		18.0	20.0	22.0	25.0	28.0	30.0	32.0	36.0	40.0	50.0
1	Vc	35	35	35	35	35	35	35	35	35	35
	fz	0.071	0.08	0.088	0.098	0.088	0.1	0.1	0.113	0.119	0.152
	RPM	619	557	506	446	398	371	348	309	279	223
	FEED	176	178	223	218	210	223	209	210	199	203
2	Vc	30	30	30	30	30	30	30	30	30	30
	fz	0.07	0.078	0.076	0.085	0.076	0.086	0.095	0.107	0.114	0.157
	RPM	531	477	434	382	341	318	298	265	239	191
	FEED	149	149	165	162	156	164	170	170	163	180
3-4	Vc	25	25	25	25	25	25	25	25	25	25
	fz	0.069	0.069	0.08	0.09	0.077	0.087	0.098	0.108	0.111	0.146
	RPM	442	398	362	318	284	265	199	221	199	159
	FEED	122	110	145	143	131	138	117	143	132	139
5	Vc	15	15	15	15	15	15	15	15	15	15
	fz	0.07	0.08	0.077	0.094	0.089	0.089	0.101	0.118	0.121	0.148
	RPM	265	239	217	191	171	159	149	133	119	95
	FEED	74	76	84	90	91	85	90	94	87	85
6	Vc	30	30	30	30	30	30	30	30	30	30
	fz	0.07	0.078	0.076	0.085	0.076	0.086	0.095	0.107	0.114	0.157
	RPM	531	477	434	382	341	318	298	265	239	191
	FEED	149	149	165	162	156	164	170	170	163	180
7	Vc	25	25	25	25	25	25	25	25	25	25
	fz	0.069	0.069	0.08	0.09	0.077	0.087	0.098	0.108	0.111	0.146
	RPM	442	398	362	318	284	265	199	221	199	159
	FEED	122	110	145	143	131	138	117	143	132	139
8-9	Vc	15	15	15	15	15	15	15	15	15	15
	fz	0.07	0.08	0.077	0.094	0.089	0.089	0.101	0.118	0.121	0.148
	RPM	265	239	217	191	171	159	149	133	119	95
	FEED	74	76	84	90	91	85	90	94	87	85
10	Vc	30	30	30	30	30	30	30	30	30	30
	fz	0.07	0.078	0.076	0.085	0.076	0.086	0.095	0.107	0.114	0.157
	RPM	531	477	434	382	341	318	298	265	239	191
	FEED	149	149	165	162	156	164	170	170	163	180
11.1	Vc	15	15	15	15	15	15	15	15	15	15
	fz	0.07	0.08	0.077	0.094	0.089	0.089	0.101	0.118	0.121	0.148
	RPM	265	239	217	191	171	159	149	133	119	95
	FEED	74	76	84	90	91	85	90	94	87	85
21-22	Vc	80	75	75	80	80	85	80	80	80	80
	fz	0.084	0.104	0.085	0.09	0.094	0.098	0.104	0.112	0.119	0.123
	RPM	1415	1194	1085	1019	909	902	796	707	637	509
	FEED	475	497	461	458	513	530	497	475	455	376
23-24	Vc	52	49	49	52	52	55	52	52	52	52
	fz	0.084	0.104	0.085	0.09	0.094	0.098	0.104	0.112	0.119	0.123
	RPM	920	780	709	662	591	584	517	460	414	331
	FEED	309	324	301	298	333	343	323	309	295	244

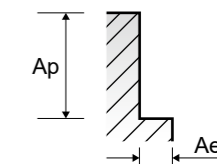

EQ753, EQ762, EQ751, EQ752 SERIES

MULTI FLUTE ROUGHING TiAlN COATED - SIDE CUTTING

Vc = m/min.
fz = mm/tooth
RPM = rev./min.
FEED = mm/min.

ISO	VDI 3323	Material Description	Ae	Ap	Parameter	Diameter (Ø)					
						6.0	8.0	10.0	12.0	14.0	16.0
P	1	Non-alloy steel	0.5D	1.5D	Vc	45	50	50	45	50	50
					fz	0.015	0.025	0.034	0.05	0.057	0.063
					RPM	2387	1989	1592	1194	1137	995
	2		Vc	40	40	40	40	45	40		
			fz	0.013	0.023	0.034	0.044	0.049	0.061		
			RPM	2122	1592	1273	1061	1023	796		
	3-4		Vc	30	30	35	35	35	35		
			fz	0.015	0.024	0.035	0.043	0.048	0.06		
			RPM	1592	1194	1114	928	796	696		
	5		Vc	20	20	20	20	20	20		
			fz	0.012	0.021	0.033	0.045	0.05	0.063		
RPM		1061	796	637	531	455	398				
6	Vc	40	40	40	40	45	40				
	fz	0.013	0.023	0.034	0.044	0.049	0.061				
	RPM	2122	1592	1273	1061	1023	796				
7	Vc	30	30	35	35	35	35				
	fz	0.015	0.024	0.035	0.043	0.048	0.06				
	RPM	1592	1194	1114	928	796	696				
8-9	Vc	20	20	20	20	20	20				
	fz	0.012	0.021	0.033	0.045	0.05	0.063				
	RPM	1061	796	637	531	455	398				
10	Vc	40	40	40	40	45	40				
	fz	0.013	0.023	0.034	0.044	0.049	0.061				
	RPM	2122	1592	1273	1061	1023	796				
11.1	Vc	20	20	20	20	20	20				
	fz	0.012	0.021	0.033	0.045	0.05	0.063				
	RPM	1061	796	637	531	455	398				
N	21-22	Aluminum-wrought alloy	0.5D	1.5D	Vc	120	110	110	105	110	115
					fz	0.015	0.025	0.035	0.05	0.059	0.07
					RPM	6366	4377	3501	2785	2501	2288
	23-24		Aluminum-cast, alloyed	Vc	78	72	72	68	72	75	
				fz	0.015	0.025	0.035	0.05	0.059	0.07	
				RPM	4138	2865	2292	1804	1637	1492	
Vc	186	215		321	361	386	418				
fz	0.015	0.025		0.035	0.05	0.059	0.07				
RPM	4138	2865		2292	1804	1637	1492				

※ The FEED, in long & extra long types, should be reduced by around 50%

▶ NEXT PAGE

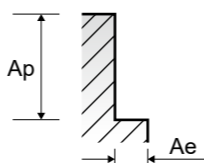

EQ753, EQ762, EQ751, EQ752 SERIES

MULTI FLUTE ROUGHING TiAlN COATED - SIDE CUTTING

Vc = m/min.
fz = mm/tooth
RPM = rev./min.
FEED = mm/min.

VDI 3323	Parameter	Diameter (Ø)									
		18.0	20.0	22.0	25.0	28.0	30.0	32.0	36.0	40.0	50.0
1	Vc	50	50	50	50	50	45	50	50	50	45
	fz	0.069	0.078	0.089	0.095	0.089	0.098	0.098	0.109	0.117	0.156
	RPM	884	796	723	637	568	477	497	442	398	286
2	Vc	40	40	45	45	45	40	40	40	40	40
	fz	0.07	0.075	0.074	0.087	0.075	0.083	0.094	0.107	0.117	0.16
	RPM	707	637	651	573	512	424	398	354	318	255
3-4	Vc	30	35	35	35	35	35	30	35	30	35
	fz	0.07	0.07	0.078	0.087	0.075	0.086	0.1	0.1	0.113	0.148
	RPM	531	557	506	446	398	371	298	309	239	223
5	Vc	20	20	20	20	20	20	20	20	15	20
	fz	0.071	0.083	0.08	0.096	0.091	0.091	0.1	0.118	0.141	0.153
	RPM	354	318	289	255	227	212	199	177	119	127
6	Vc	40	40	45	45	45	40	40	40	40	40
	fz	0.07	0.075	0.074	0.087	0.075	0.083	0.094	0.107	0.117	0.16
	RPM	707	637	651	573	512	424	398	354	318	255
7	Vc	30	35	35	35	35	35	30	35	30	35
	fz	0.07	0.07	0.078	0.087	0.075	0.086	0.1	0.1	0.113	0.148
	RPM	531	557	506	446	398	371	298	309	239	223
8-9	Vc	20	20	20	20	20	20	20	20	15	20
	fz	0.071	0.083	0.08	0.096	0.091	0.091	0.1	0.118	0.141	0.153
	RPM	354	318	289	255	227	212	199	177	119	127
10	Vc	40	40	45	45	45	40	40	40	40	40
	fz	0.07	0.075	0.074	0.087	0.075	0.083	0.094	0.107	0.117	0.16
	RPM	707	637	651	573	512	424	398	354	318	255
11.1	Vc	20	20	20	20	20	20	20	20	15	20
	fz	0.071	0.083	0.08	0.096	0.091	0.091	0.1	0.118	0.141	0.153
	RPM	354	318	289	255	227	212	199	177	119	127
21-22	Vc	110	105	105	110	110	120	110	115	115	110
	fz	0.085	0.103	0.085	0.09	0.095	0.099	0.106	0.11	0.117	0.124
	RPM	1945	1671	1519	1401	1251	1273	1094	1017	915	700
23-24	Vc	72	68	68	72	72	78	72	75	75	72
	fz	0.085	0.103	0.085	0.09	0.095	0.099	0.106	0.11	0.117	0.124
	RPM	1273	1082	984	917	819	828	716	663	597	458

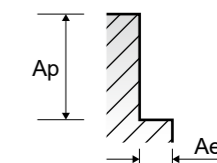



RECOMMENDED CUTTING CONDITIONS
EMPFOHLENE SCHNEIDPARAMETER

E2595 SERIES 4FLUTE - SIDE CUTTING

Vc = m/min.
fz = mm/tooth
RPM = rev./min.
FEED = mm/min.

ISO	VDI 3323	Material Description	Ae	Ap	Parameter	Diameter (Ø)						
						2.0	3.0	4.0	5.0	6.0	8.0	10.0
P	1	Non-alloy steel	0.1D	1.5D	Vc	35	35	35	35	35	35	35
					fz	0.004	0.008	0.013	0.02	0.025	0.036	0.045
					RPM	5570	3714	2785	2228	1857	1393	1114
	2		Vc	30	30	30	30	30	30	30		
			fz	0.003	0.006	0.011	0.017	0.023	0.036	0.044		
			RPM	4775	3183	2387	1910	1592	1194	955		
	3-4		Vc	25	25	25	25	25	25	25		
			fz	0.003	0.006	0.009	0.014	0.019	0.029	0.038		
			RPM	3979	2653	1989	1592	1326	995	796		
	5		Vc	15	15	15	15	15	15	15		
			fz	0.002	0.005	0.01	0.014	0.019	0.029	0.036		
RPM		2387	1592	1194	955	796	597	477				
6	Vc	30	30	30	30	30	30	30				
	fz	0.003	0.006	0.011	0.017	0.023	0.036	0.044				
	RPM	4775	3183	2387	1910	1592	1194	955				
7	Vc	25	25	25	25	25	25	25				
	fz	0.003	0.006	0.009	0.014	0.019	0.029	0.038				
	RPM	3979	2653	1989	1592	1326	995	796				
8-9	Vc	15	15	15	15	15	15	15				
	fz	0.002	0.005	0.01	0.014	0.019	0.029	0.036				
	RPM	2387	1592	1194	955	796	597	477				
10	Vc	30	30	30	30	30	30	30				
	fz	0.003	0.006	0.011	0.017	0.023	0.036	0.044				
	RPM	4775	3183	2387	1910	1592	1194	955				
11.1	Vc	15	15	15	15	15	15	15				
	fz	0.002	0.005	0.01	0.014	0.019	0.029	0.036				
	RPM	2387	1592	1194	955	796	597	477				
N	21-22	Aluminum-wrought alloy	0.1D	1.5D	Vc	75	105	100	100	105	100	95
					fz	0.005	0.009	0.014	0.019	0.021	0.036	0.048
					RPM	11937	11141	7958	6366	5570	3979	3024
23-24	Aluminum-cast, alloyed	0.1D	1.5D	Vc	49	68	65	65	68	65	62	
				fz	0.005	0.009	0.014	0.019	0.021	0.036	0.048	
				RPM	7799	7215	5173	4138	3608	2586	1974	

※ The FEED, in long & extra long types, should be reduced by around 50%

▶ NEXT PAGE

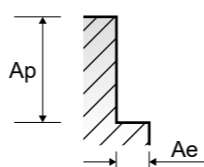

RECOMMENDED CUTTING CONDITIONS
EMPFOHLENE SCHNEIDPARAMETER

E2595 SERIES 4 FLUTE - SIDE CUTTING

Vc = m/min.
fz = mm/tooth
RPM = rev./min.
FEED = mm/min.

VDI 3323	Parameter	Diameter (Ø)												
		12.0	14.0	16.0	18.0	20.0	22.0	25.0	28.0	30.0	32.0	36.0	40.0	
1	Vc	35	35	35	35	35	35	35	35	35	35	35	35	35
	fz	0.061	0.069	0.079	0.079	0.089	0.1	0.1	0.067	0.067	0.067	0.065	0.071	
	RPM	928	796	696	619	557	506	446	398	371	348	309	279	
2	Vc	30	30	30	30	30	30	30	30	30	30	30	30	
	fz	0.056	0.057	0.071	0.08	0.089	0.089	0.091	0.06	0.059	0.06	0.06	0.068	
	RPM	796	682	597	531	477	434	382	341	318	298	265	239	
3-4	Vc	25	25	25	25	25	25	25	25	25	25	25	25	
	fz	0.048	0.054	0.058	0.066	0.066	0.075	0.073	0.048	0.05	0.049	0.05	0.056	
	RPM	663	568	497	442	398	362	318	284	265	199	221	199	
5	Vc	15	15	15	15	15	15	15	15	15	15	15	15	
	fz	0.047	0.054	0.058	0.065	0.074	0.074	0.069	0.047	0.047	0.054	0.049	0.053	
	RPM	398	341	298	265	239	217	191	171	159	149	133	119	
6	Vc	30	30	30	30	30	30	30	30	30	30	30	30	
	fz	0.056	0.057	0.071	0.08	0.089	0.089	0.091	0.06	0.059	0.06	0.06	0.068	
	RPM	796	682	597	531	477	434	382	341	318	298	265	239	
7	Vc	25	25	25	25	25	25	25	25	25	25	25	25	
	fz	0.048	0.054	0.058	0.066	0.066	0.075	0.073	0.048	0.05	0.049	0.05	0.056	
	RPM	663	568	497	442	398	362	318	284	265	199	221	199	
8-9	Vc	15	15	15	15	15	15	15	15	15	15	15	15	
	fz	0.047	0.054	0.058	0.065	0.074	0.074	0.069	0.047	0.047	0.054	0.049	0.053	
	RPM	398	341	298	265	239	217	191	171	159	149	133	119	
10	Vc	30	30	30	30	30	30	30	30	30	30	30	30	
	fz	0.056	0.057	0.071	0.08	0.089	0.089	0.091	0.06	0.059	0.06	0.06	0.068	
	RPM	796	682	597	531	477	434	382	341	318	298	265	239	
11.1	Vc	15	15	15	15	15	15	15	15	15	15	15	15	
	fz	0.047	0.054	0.058	0.065	0.074	0.074	0.069	0.047	0.047	0.054	0.049	0.053	
	RPM	398	341	298	265	239	217	191	171	159	149	133	119	
21-22	Vc	95	95	100	100	100	95	95	95	105	100	100	100	
	fz	0.057	0.06	0.066	0.074	0.075	0.08	0.088	0.061	0.06	0.06	0.061	0.06	
	RPM	2520	2160	1989	1768	1592	1375	1210	1080	1114	995	884	796	
23-24	Vc	62	62	65	65	65	62	62	62	68	65	65	65	
	fz	0.057	0.06	0.066	0.074	0.075	0.08	0.088	0.061	0.06	0.06	0.061	0.06	
	RPM	1645	1410	1293	1149	1035	897	789	705	722	647	575	517	

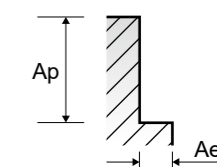



RECOMMENDED CUTTING CONDITIONS
EMPFOHLENE SCHNEIDPARAMETER

EQ595 SERIES 4 FLUTE TiAlN COATED - SIDE CUTTING

Vc = m/min.
fz = mm/tooth
RPM = rev./min.
FEED = mm/min.

ISO	VDI 3323	Material Description	Ae	Ap	Parameter	Diameter (Ø)						
						2.0	3.0	4.0	5.0	6.0	8.0	10.0
P	1	Non-alloy steel	0.1D	1.5D	Vc	50	45	50	50	45	50	50
					fz	0.004	0.008	0.013	0.02	0.025	0.036	0.045
					RPM	7958	4775	3979	3183	2387	1989	1592
	2		0.1D	1.5D	Vc	40	40	40	40	40	40	40
					fz	0.003	0.006	0.011	0.018	0.023	0.036	0.045
					RPM	6366	4244	3183	2546	2122	1592	1273
	3-4		0.1D	1.5D	Vc	35	35	30	35	30	30	35
					fz	0.003	0.006	0.009	0.014	0.018	0.029	0.039
					RPM	5570	3714	2387	2228	1592	1194	1114
	5		0.1D	1.5D	Vc	20	20	20	20	20	20	20
					fz	0.002	0.004	0.01	0.014	0.019	0.028	0.035
RPM		3183			2122	1592	1273	1061	796	637		
6	0.1D	1.5D	Vc	40	40	40	40	40	40	40		
			fz	0.003	0.006	0.011	0.018	0.023	0.036	0.045		
			RPM	6366	4244	3183	2546	2122	1592	1273		
7	0.1D	1.5D	Vc	35	35	30	35	30	30	35		
			fz	0.003	0.006	0.009	0.014	0.018	0.029	0.039		
			RPM	5570	3714	2387	2228	1592	1194	1114		
8-9	0.1D	1.5D	Vc	20	20	20	20	20	20	20		
			fz	0.002	0.004	0.01	0.014	0.019	0.028	0.035		
			RPM	3183	2122	1592	1273	1061	796	637		
10	0.1D	1.5D	Vc	40	40	40	40	40	40	40		
			fz	0.003	0.006	0.011	0.018	0.023	0.036	0.045		
			RPM	6366	4244	3183	2546	2122	1592	1273		
11.1	0.1D	1.5D	Vc	20	20	20	20	20	20	20		
			fz	0.002	0.004	0.01	0.014	0.019	0.028	0.035		
			RPM	3183	2122	1592	1273	1061	796	637		
21-22	0.1D	1.5D	Vc	105	145	140	140	150	140	135		
			fz	0.005	0.009	0.014	0.019	0.021	0.036	0.048		
			RPM	16711	15385	11141	8913	7958	5570	4297		
23-24	0.1D	1.5D	Vc	68	94	91	91	98	91	88		
			fz	0.005	0.009	0.014	0.019	0.021	0.036	0.048		
			RPM	10823	9974	7242	5793	5199	3621	2801		
FEED						216	359	406	440	437	521	538

※ The FEED, in long & extra long types, should be reduced by around 50%

▶ NEXT PAGE

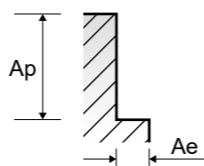

RECOMMENDED CUTTING CONDITIONS
EMPFOHLENE SCHNEIDPARAMETER

EQ595 SERIES 4 FLUTE TiAlN COATED - SIDE CUTTING

Vc = m/min.
fz = mm/tooth
RPM = rev./min.
FEED = mm/min.

VDI 3323	Parameter	Diameter (Ø)											
		12.0	14.0	16.0	18.0	20.0	22.0	25.0	28.0	30.0	32.0	36.0	40.0
1	Vc	45	50	50	50	50	50	50	50	45	50	50	50
	fz	0.062	0.07	0.078	0.078	0.088	0.1	0.096	0.068	0.065	0.065	0.063	0.071
	RPM	1194	1137	995	884	796	723	637	568	477	497	442	398
2	Vc	40	45	40	40	40	45	45	45	40	40	40	40
	fz	0.057	0.056	0.07	0.08	0.087	0.087	0.093	0.058	0.057	0.058	0.06	0.069
	RPM	1061	1023	796	707	637	651	573	512	424	398	354	318
3-4	Vc	35	35	35	30	35	35	35	35	30	35	30	30
	fz	0.047	0.053	0.056	0.066	0.066	0.073	0.069	0.046	0.05	0.05	0.047	0.057
	RPM	928	796	696	531	557	506	446	398	371	298	309	239
5	Vc	20	20	20	20	20	20	20	20	20	20	15	20
	fz	0.048	0.053	0.056	0.064	0.075	0.075	0.07	0.054	0.054	0.054	0.056	0.056
	RPM	531	455	398	354	318	289	255	227	212	199	133	159
6	Vc	40	45	40	40	40	45	45	45	40	40	40	40
	fz	0.057	0.056	0.07	0.08	0.087	0.087	0.093	0.058	0.057	0.058	0.06	0.069
	RPM	1061	1023	796	707	637	651	573	512	424	398	354	318
7	Vc	35	35	35	30	35	35	35	35	30	35	30	30
	fz	0.047	0.053	0.056	0.066	0.066	0.073	0.069	0.046	0.05	0.05	0.047	0.057
	RPM	928	796	696	531	557	506	446	398	371	298	309	239
8-9	Vc	20	20	20	20	20	20	20	20	20	20	15	20
	fz	0.048	0.053	0.056	0.064	0.075	0.075	0.07	0.054	0.054	0.054	0.056	0.056
	RPM	531	455	398	354	318	289	255	227	212	199	133	159
10	Vc	40	45	40	40	40	45	45	45	40	40	40	40
	fz	0.057	0.056	0.07	0.08	0.087	0.087	0.093	0.058	0.057	0.058	0.06	0.069
	RPM	1061	1023	796	707	637	651	573	512	424	398	354	318
11.1	Vc	20	20	20	20	20	20	20	20	20	20	15	20
	fz	0.048	0.053	0.056	0.064	0.075	0.075	0.07	0.054	0.054	0.054	0.056	0.056
	RPM	531	455	398	354	318	289	255	227	212	199	133	159
21-22	Vc	130	135	140	140	140	135	135	135	145	140	140	140
	fz	0.057	0.06	0.066	0.074	0.074	0.081	0.087	0.06	0.06	0.06	0.061	0.064
	RPM	3448	3069	2785	2476	2228	1953	1719	1535	1538	1393	1238	1114
23-24	Vc	85	88	91	91	91	88	88	88	94	91	91	91
	fz	0.057	0.06	0.066	0.074	0.074	0.081	0.087	0.06	0.06	0.06	0.061	0.064
	RPM	2255	2001	1810	1609	1448	1273	1120	1000	997	905	805	724
FEED		514	480	478	476	429	413	390	360	359	326	294	278

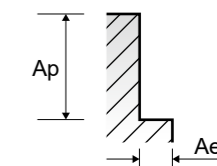



RECOMMENDED CUTTING CONDITIONS
EMPFOHLENE SCHNEIDPARAMETER

E2755 SERIES 3 FLUTE ROUGHING - SIDE CUTTING

Vc = m/min.
fz = mm/tooth
RPM = rev./min.
FEED = mm/min.

ISO	VDI 3323	Material Description	Ae	Ap	Parameter	Diameter (Ø)			
						6.0	8.0	10.0	12.0
P	1	Non-alloy steel	0.5D	1.5D	Vc	35	35	35	35
					fz	0.015	0.025	0.045	0.067
					RPM	1857	1393	1114	928
	FEED		84	104	150	187			
	2		Vc	30	30	30	30		
			fz	0.013	0.023	0.044	0.058		
			RPM	1592	1194	955	796		
	FEED		62	82	126	138			
	3-4		Vc	25	25	25	25		
			fz	0.015	0.024	0.046	0.058		
			RPM	1326	995	796	663		
FEED	60	72	110	115					
5	Vc	15	15	15	15				
	fz	0.013	0.021	0.044	0.058				
	RPM	796	597	477	398				
FEED	31	38	63	69					
6	Vc	30	30	30	30				
	fz	0.013	0.023	0.044	0.058				
	RPM	1592	1194	955	796				
FEED	62	82	126	138					
7	Vc	25	25	25	25				
	fz	0.015	0.024	0.046	0.058				
	RPM	1326	995	796	663				
FEED	60	72	110	115					
8-9	Vc	15	15	15	15				
	fz	0.013	0.021	0.044	0.058				
	RPM	796	597	477	398				
FEED	31	38	63	69					
10	Vc	30	30	30	30				
	fz	0.013	0.023	0.044	0.058				
	RPM	1592	1194	955	796				
FEED	62	82	126	138					
11.1	Vc	15	15	15	15				
	fz	0.013	0.021	0.044	0.058				
	RPM	796	597	477	398				
FEED	31	38	63	69					
21-22	Vc	85	80	80	75				
	fz	0.015	0.025	0.047	0.067				
	RPM	4509	3183	2546	1989				
FEED	203	239	359	400					
23-24	Vc	55	52	52	49				
	fz	0.015	0.025	0.047	0.067				
	RPM	2918	2069	1655	1300				
FEED	131	155	233	261					

※ The FEED, in long & extra long types, should be reduced by around 50%

▶ NEXT PAGE

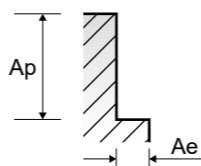

RECOMMENDED CUTTING CONDITIONS
EMPFOHLENE SCHNEIDPARAMETER

E2755 SERIES 3 FLUTE ROUGHING - SIDE CUTTING

Vc = m/min.
fz = mm/tooth
RPM = rev./min.
FEED = mm/min.

VDI 3323	Parameter	Diameter (Ø)						
		14.0	16.0	18.0	20.0	22.0	25.0	30.0
1	Vc	35	35	35	35	35	35	35
	fz	0.075	0.086	0.095	0.107	0.147	0.163	0.2
	RPM	796	696	619	557	506	446	371
	FEED	179	180	176	179	223	218	223
2	Vc	30	30	30	30	30	30	30
	fz	0.067	0.083	0.093	0.104	0.126	0.142	0.172
	RPM	682	597	531	477	434	382	318
	FEED	137	149	148	149	164	163	164
3-4	Vc	25	25	25	25	25	25	25
	fz	0.065	0.081	0.092	0.092	0.133	0.151	0.173
	RPM	568	497	442	398	362	318	265
	FEED	111	121	122	110	144	144	138
5	Vc	15	15	15	15	15	15	15
	fz	0.067	0.083	0.093	0.106	0.129	0.157	0.177
	RPM	341	298	265	239	217	191	159
	FEED	69	74	74	76	84	90	85
6	Vc	30	30	30	30	30	30	30
	fz	0.067	0.083	0.093	0.104	0.126	0.142	0.172
	RPM	682	597	531	477	434	382	318
	FEED	137	149	148	149	164	163	164
7	Vc	25	25	25	25	25	25	25
	fz	0.065	0.081	0.092	0.092	0.133	0.151	0.173
	RPM	568	497	442	398	362	318	265
	FEED	111	121	122	110	144	144	138
8-9	Vc	15	15	15	15	15	15	15
	fz	0.067	0.083	0.093	0.106	0.129	0.157	0.177
	RPM	341	298	265	239	217	191	159
	FEED	69	74	74	76	84	90	85
10	Vc	30	30	30	30	30	30	30
	fz	0.067	0.083	0.093	0.104	0.126	0.142	0.172
	RPM	682	597	531	477	434	382	318
	FEED	137	149	148	149	164	163	164
11.1	Vc	15	15	15	15	15	15	15
	fz	0.067	0.083	0.093	0.106	0.129	0.157	0.177
	RPM	341	298	265	239	217	191	159
	FEED	69	74	74	76	84	90	85
21-22	Vc	80	80	80	75	75	80	85
	fz	0.078	0.094	0.112	0.139	0.142	0.15	0.196
	RPM	1819	1592	1415	1194	1085	1019	902
	FEED	426	449	475	498	462	458	530
23-24	Vc	52	52	52	49	49	52	55
	fz	0.078	0.094	0.112	0.139	0.142	0.15	0.196
	RPM	1182	1035	920	780	709	662	584
	FEED	277	292	309	325	302	298	343

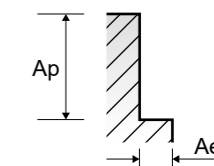



Global Cutting Tool Leader **YG-1**



MILLING



Leading Through Innovation

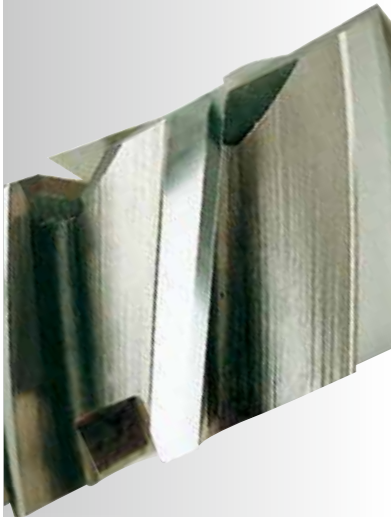

HSS

MILLING CUTTERS

HSS Fräser

- General Works. Available Dovetail, Woodruff Keyseat, T-slot, Side Milling Cutters and HSS (8% cobalt) Corner Rounding, Shell End Mills
- Allgemeine Arbeiten. Verfügbare Schwalbenschwanz, Passfedernut, T-Nut, Scheibenfräser, Scheibenfräser und HSS (8% Kobalt) Eckenverrundung, Walzenstirnfräser

SELECTION GUIDE



MILLING TOOLS

SERIES	ML012, ML022 ML112, ML122	ML032, ML042 ML132, ML142	ML062 ML162
	DOVETAIL CUTTERS	DOVETAIL CUTTERS	WOODRUFF KEYSEAT CUTTERS
FLUTE	-	-	-
HELIX ANGLE	0°	0°	10°-20°
SIZE MIN	D16.0	D16.0	D10.5
SIZE MAX	D50.0	D38.0	D45.5
PAGE	C706	C707	C708

HSS MILLING CUTTERS

General Works. Available Dovetail, Woodruff Keyseat, T-slot, Side Milling Cutters and HSS (8% cobalt) Corner Rounding, Shell End Mills



Please visit globalyg1.com/mat for material search

◎ : Excellent ○ : Good

Recommended cutting conditions : p. C726



ISO	VDI 3323	Material Description	Composition / Structure / Heat Treatment	HB	HRc	ML012, ML022 ML112, ML122	ML032, ML042 ML132, ML142	ML062 ML162	
P	1	Non-alloy steel	About 0.15% C Annealed	125		◎	◎	◎	
	2		About 0.45% C Annealed	190	13	◎	◎	◎	
	3		About 0.45% C Quenched & Tempered	250	25	◎	◎	◎	
	4		About 0.75% C Annealed	270	28	◎	◎	◎	
	5		About 0.75% C Quenched & Tempered	300	32	◎	◎	◎	
	6	Low alloy steel	Annealed	180	10	◎	◎	◎	
	7		Quenched & Tempered	275	29	◎	◎	◎	
	8		Quenched & Tempered	300	32	◎	◎	◎	
	9		Quenched & Tempered	350	38	○	○	○	
	10		High alloyed steel, and tool steel	Annealed	200	15	◎	◎	◎
	11			Quenched & Tempered	325	35	○	○	○
M	12	Stainless steel	Ferritic / Martensitic Annealed	200	15				
	13		Martensitic Quenched & Tempered	240	23				
	14		Austenitic	180	10				
K	15	Grey cast iron	Pearlitic / ferritic	180	10				
	16		Pearlitic (Martensitic)	260	26				
	17	Nodular cast iron	Ferritic	160	3				
	18		Pearlitic	250	25				
	19	Malleable cast iron	Ferritic	130					
	20		Pearlitic	230	21				
N	21	Aluminum-wrought alloy	Not Curable	60		○	○	○	
	22		Curable Hardened	100		○	○	○	
	23	Aluminum-cast, alloyed	≤ 12% Si, Not Curable	75		○	○	○	
	24		≤ 12% Si, Curable Hardened	90		○	○	○	
	25		> 12% Si, Not Curable	130		○	○	○	
	26		Copper and Copper Alloys	Cutting Alloys, PB>1%	110				
	27	(Bronze / Brass)	CuZn, CuSnZn (Brass)	90					
	28		CuSn, lead-free copper and electrolytic copper	100					
	29	Non Metallic Materials	Duroplastic, Fiber Reinforced Plastic						
	30		Rubber, Wood, etc.						
S	31	Heat Resistant Super Alloys	Fe Based Annealed	200	15				
	32		Cured	280	30				
	33		Annealed	250	25				
	34		Ni or Co Based Cured	350	38				
	35		Cast	320	34				
	36	Titanium Alloys	Pure Titanium	400 Rm					
37	Alpha + Beta Alloys Hardened		1050 Rm						
H	38	Hardened steel	Hardened	550	55				
	39		Hardened	630	60				
	40	Hardened Cast Iron	Cast	400	42				
	41		Hardened	550	55				

HSS

ML072 ML172	ML092	ML102	E2675	E2676	E2677	E2678	E2679	E2498
T-SLOT CUTTERS	SIDE AND FACE MILLING CUTTERS	SIDE AND FACE MILLING CUTTERS	SHELL END MILL	SHELL END MILL	ROUGHING SHELL END MILL	ROUGHING SHELL END MILL	ROUGHING & FINISHING SHELL END MILL	CORNER ROUNDING CUTTERS
-	-	-	Multi Flute	Multi Flute	Multi Flute	Multi Flute	Multi Flute	4
10°-20°	10°	-	30°	42°	30°	30°	30°	0°
D12.5	D50.0	D50.0	D30.0	D30.0	D40.0	D40.0	D40.0	D8.0
D40.0	D125.0	D200.0	D160.0	D100.0	D160.0	D160.0	D160.0	D56.0
C709	C711	C713	C719	C720	C721	C722	C723	C724
Type AA, AB, AD	with STRAIGHT TEETH	with STAGGERED TEETH	-	for ALUMINUM	-	-	-	-
Uncoated	Uncoated	Uncoated	Uncoated	Uncoated	Uncoated	Uncoated	Uncoated	Uncoated
HSS-E	HSS-E	HSS-E	HSS Co8	HSS Co8	HSS Co8	HSS Co8	HSS Co8	HSS Co8



◎	◎	◎	◎	○	◎	◎	◎	◎	◎	1
◎	◎	◎	◎	○	◎	◎	◎	◎	◎	2
◎	◎	◎	◎	○	◎	◎	◎	◎	◎	3
◎	◎	◎	◎	○	◎	◎	◎	◎	◎	4
◎	◎	◎	◎	○	◎	○	○	○	○	5
◎	◎	◎	◎	○	◎	◎	◎	◎	◎	6
◎	◎	◎	◎	○	◎	◎	◎	◎	◎	7
◎	◎	◎	◎	○	◎	○	○	○	○	8
◎	○	○	○	○	○	○	○	○	○	9
◎	◎	◎	◎	○	◎	◎	◎	◎	◎	10
○	○	○	○	○	○	○	○	○	○	11
										12
										13
										14
										15
										16
										17
										18
										19
										20
○	○	○	○	◎	○	○	○	○	○	21
○	○	○	○	◎	○	○	○	○	○	22
○	○	○	○	◎	○	○	○	○	○	23
○	○	○	○	◎	○	○	○	○	○	24
○	○	○	○	◎	○	○	○	○	○	25
										26
										27
										28
										29
										30
										31
										32
										33
										34
										35
										36
										37
										38
										39
										40
										41



PLAIN SHANK **ML012, ML022** SERIES
 FLAT SHANK **ML112, ML122** SERIES

HSS-E, DOVETAIL CUTTERS TYPE "A", "C", "E"

- HSS-E, WINKELFRÄSER FORM "A", "C", "E"
- Fraise HSS-E pour queue d'aronde Type "A", "C", "E"
- FRESE AD ANGOLO DIVERGENTE TIPO "A", "C", "E"

▶ Recommended for use in place of arbor and threaded hole type cutters to reduce set time and facilitate handling.

▶ Empfohlen zur Nutzung anstelle von Arbor and threaded hole type Cutters um Montierzeit zu verkürzen und Handhabung zu erleichtern.

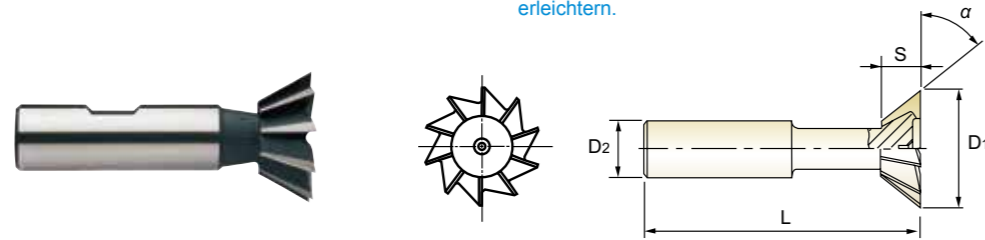

HSS-E DIN 1833 N 0° DIN 1835A DIN 1835B UNCOATED p.C726

Unit : mm

EDP No.		Cutter Diameter	Width of Face	Divergent Taper Angle	Shank Diameter	Overall Length	No. of Teeth
PLAIN	FLAT	D ₁ (js16)	S(js14)	α(± 15')	D ₂ (h6)	L(js18)	Z
ML01201601	ML11201601	16.0	4	45°	12	60	6
ML01202001	ML11202001	20.0	5	45°	12	63	6
ML01202201	ML11202201	22.0	6	45°	12	67	6
ML01202501	ML11202501	25.0	6.3	45°	16	67	8
ML01202801	ML11202801	28.0	7.5	45°	16	67	8
ML01203201	ML11203201	32.0	8	45°	16	71	10
ML01203801	ML11203801	38.0	10	45°	16	80	12
ML02201601	ML12201601	16.0	6.3	60°	12	60	6
ML02202001	ML12202001	20.0	8	60°	12	63	6
ML02202201	ML12202201	22.0	9	60°	12	67	6
ML02202501	ML12202501	25.0	10	60°	16	67	8
ML02202801	ML12202801	28.0	11	60°	16	67	8
ML02203201	ML12203201	32.0	12.5	60°	16	71	10
ML02203801	ML12203801	38.0	16	60°	16	80	12
ML02204001	ML12204001	40.0	13	60°	25	85	12
ML02205001	ML12205001	50.0	16	60°	25	100	16

Tolerances according to DIN 7160 & 7161

	Nominal-Diameter in mm						
	over3 to6	over6 to10	over10 to18	over18 to30	over30 to50	over50 to80	over80 to120
Tolerance range in mm							
js16	± 0.375	± 0.45	± 0.55	± 0.65	± 0.80	± 0.95	± 1.10
js14	± 0.15	± 0.18	± 0.215	± 0.26	± 0.31	± 0.37	± 0.435
js18	± 0.90	± 1.10	± 1.35	± 1.65	± 1.95	± 2.30	± 2.70
Tolerance range in μm							
h6	0 - 8	0 - 9	0 - 11	0 - 13	0 - 16	0 - 19	0 - 22

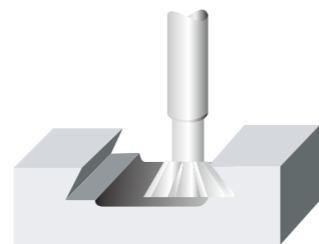

◎ : Excellent ○ : Good

ISO	P										M				K					
	Non-alloy steel					Low alloy steel					High alloyed steel, and tool steel		Stainless steel		Grey cast iron	Nodular cast iron	Malleable cast iron			
Material Description	1	2	3	4	5	6	7	8	9	10	11	12	13	14	15	16	17	18	19	20
VDI 3323	1	2	3	4	5	6	7	8	9	10	11	12	13	14	15	16	17	18	19	20
HRc	13	25	28	32	35	38	40	42	45	48	50	52	55	58	60	62	65	68	70	72
HB	125	190	250	270	300	350	380	420	450	500	550	200	240	180	180	260	160	250	130	230
Recommended	◎	◎	◎	◎	◎	◎	◎	◎	◎	◎	◎	◎	◎	◎	◎	◎	◎	◎	◎	◎



PLAIN SHANK **ML032, ML042** SERIES
 FLAT SHANK **ML132, ML142** SERIES

HSS-E, DOVETAIL CUTTERS TYPE "B", "D", "F"

- HSS-E, WINKELFRÄSER FORM "B", "D", "F"
- Fraise HSS-E pour queue d'arronde Type "B", "D", "F"
- FRESE AD ANGOLO CONVERGENTE TIPO "B", "D", "F"

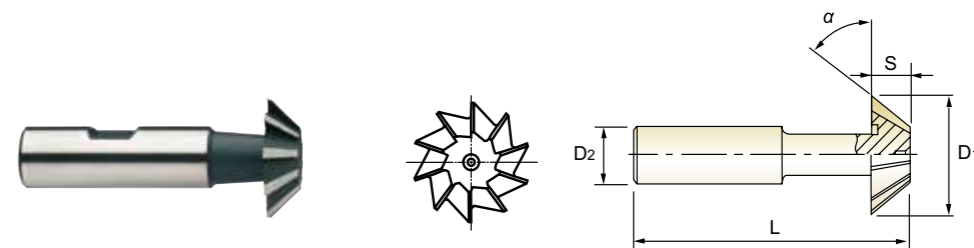

HSS-E DIN 1833 N 0° DIN 1835A DIN 1835B UNCOATED p.C727

Unit : mm

EDP No.		Cutter Diameter	Width of Face	Divergent Taper Angle	Shank Diameter	Overall Length	No. of Teeth
PLAIN	FLAT	D ₁ (js16)	S(js14)	α(± 15')	D ₂ (h6)	L(js18)	Z
ML03201601	ML13201601	16.0	4	45°	12	60	6
ML03202001	ML13202001	20.0	5	45°	12	63	6
ML03202201	ML13202201	22.0	6	45°	12	67	6
ML03202501	ML13202501	25.0	6.3	45°	16	67	8
ML03202801	ML13202801	28.0	7.5	45°	16	67	8
ML03203201	ML13203201	32.0	8	45°	16	71	10
ML03203801	ML13203801	38.0	10	45°	16	80	12
ML04201601	ML14201601	16.0	6.3	60°	12	60	6
ML04202001	ML14202001	20.0	8	60°	12	63	6
ML04202201	ML14202201	22.0	9	60°	12	67	6
ML04202501	ML14202501	25.0	10	60°	16	67	8
ML04202801	ML14202801	28.0	11	60°	16	67	8
ML04203201	ML14203201	32.0	12.5	60°	16	71	10
ML04203801	ML14203801	38.0	16	60°	16	80	12

Tolerances according to DIN 7160 & 7161

	Nominal-Diameter in mm						
	over3 to6	over6 to10	over10 to18	over18 to30	over30 to50	over50 to80	over80 to120
Tolerance range in mm							
js16	± 0.375	± 0.45	± 0.55	± 0.65	± 0.80	± 0.95	± 1.10
js14	± 0.15	± 0.18	± 0.215	± 0.26	± 0.31	± 0.37	± 0.435
js18	± 0.90	± 1.10	± 1.35	± 1.65	± 1.95	± 2.30	± 2.70
Tolerance range in μm							
h6	0 - 8	0 - 9	0 - 11	0 - 13	0 - 16	0 - 19	0 - 22

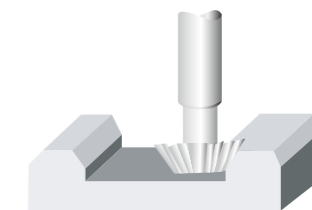

◎ : Excellent ○ : Good

ISO	P										M				K					
	Non-alloy steel					Low alloy steel					High alloyed steel, and tool steel		Stainless steel		Grey cast iron	Nodular cast iron	Malleable cast iron			
Material Description	1	2	3	4	5	6	7	8	9	10	11	12	13	14	15	16	17	18	19	20
VDI 3323	1	2	3	4	5	6	7	8	9	10	11	12	13	14	15	16	17	18	19	20
HRc	13	25	28	32	35	38	40	42	45	48	50	52	55	58	60	62	65	68	70	72
HB	125	190	250	270	300	350	380	420	450	500	550	200	240	180	180	260	160	250	130	230
Recommended	◎	◎	◎	◎	◎	◎	◎	◎	◎	◎	◎	◎	◎	◎	◎	◎	◎	◎	◎	◎



PLAIN SHANK **ML062** SERIES
 FLAT SHANK **ML162** SERIES

HSS-E, WOODRUFF KEYSEAT CUTTERS TYPE "B", "D", "F"

- HSS-E, SCHLITZFRÄSER FORM "B", "D", "F"
- Fraise HSS-E WOODRUFF Type "B", "D", "F"
- FRESE PER CHIAVETTE WOODRUFF TIPO "B", "D", "F"

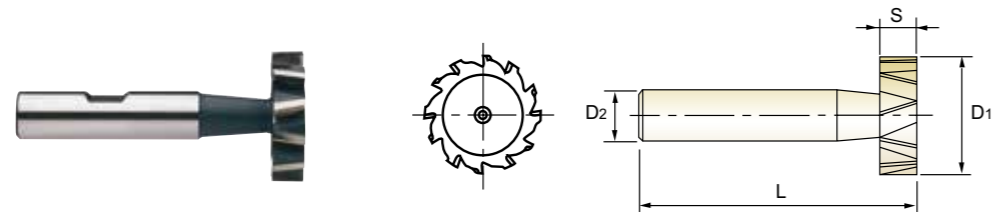

HSS-E DIN 850 N 10~12° DIN 1835A DIN 1835B UNCOATED p.C728

Unit : mm

EDP No.	Cutter Diameter	Width of Face	Shank Diameter	Overall Length	No. of Teeth	
						PLAIN
ML06210E01	ML16210E01	10.5	2	6	50	8
ML06210E02	ML16210E02	10.5	2.5	6	50	8
ML06210E03	ML16210E03	10.5	3	6	50	8
ML06213E01	ML16213E01	13.5	2	10	56	8
ML06213E02	ML16213E02	13.5	2.5	10	56	8
ML06213E03	ML16213E03	13.5	3	10	56	8
ML06213E04	ML16213E04	13.5	4	10	56	8
ML06216E01	ML16216E01	16.5	2.5	10	56	8
ML06216E02	ML16216E02	16.5	3	10	56	8
ML06216E03	ML16216E03	16.5	4	10	56	8
ML06216E04	ML16216E04	16.5	5	10	56	8
ML06219E01	ML16219E01	19.5	3	10	56	8
ML06219E02	ML16219E02	19.5	4	10	63	8
ML06219E03	ML16219E03	19.5	5	10	63	8
ML06219E04	ML16219E04	19.5	6	10	63	8
ML06222E01	ML16222E01	22.5	4	10	63	10
ML06222E02	ML16222E02	22.5	5	10	63	10
ML06222E03	ML16222E03	22.5	6	10	63	10
ML06222E04	ML16222E04	22.5	8	10	63	10
ML06225E01	ML16225E01	25.5	5	10	63	10

Tolerances according to DIN 7160 & 7161

▶ NEXT PAGE

	Nominal-Diameter in mm					
	from 1 to 3	over 3 to 6	over 6 to 10	over 10 to 18	over 18 to 30	over 30 to 80
js18	± 0.90	± 1.10	± 1.35	± 1.65	± 1.95	± 2.30
h11	0	0	0	0	0	0
e8	-14	-20	-25	-32	-40	-60
h6	0	0	0	0	0	0

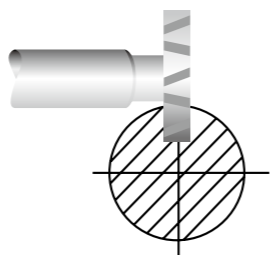

◎ : Excellent ○ : Good

ISO	P										M				K					
	Non-alloy steel					Low alloy steel					High alloyed steel, and tool steel		Stainless steel		Grey cast iron	Nodular cast iron		Malleable cast iron		
VDI 3323	1	2	3	4	5	6	7	8	9	10	11	12	13	14	15	16	17	18	19	20
HRc	13	25	28	32	35	38	40	42	45	48	50	52	55	58	60	62	65	68	70	72
HB	125	190	250	270	300	180	275	300	350	200	325	200	240	180	180	260	160	250	130	230
Recommended	◎	◎	◎	◎	◎	◎	◎	◎	◎	◎	◎	◎	◎	◎	◎	◎	◎	◎	◎	◎



PLAIN SHANK **ML062** SERIES
 FLAT SHANK **ML162** SERIES

HSS-E, WOODRUFF KEYSEAT CUTTERS TYPE "B", "D", "F"

- HSS-E, SCHLITZFRÄSER FORM "B", "D", "F"
- Fraise HSS-E WOODRUFF Type "B", "D", "F"
- FRESE PER CHIAVETTE WOODRUFF TIPO "B", "D", "F"

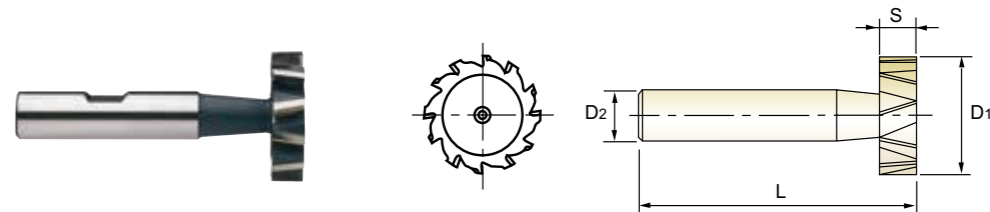

HSS-E DIN 850 N 10~12° DIN 1835A DIN 1835B UNCOATED p.C728

Unit : mm

EDP No.	Cutter Diameter	Width of Face	Shank Diameter	Overall Length	No. of Teeth	
						PLAIN
ML06225E02	ML16225E02	25.5	6	10	63	10
ML06225E03	ML16225E03	25.5	7	10	63	10
ML06225E04	ML16225E04	25.5	8	10	63	10
ML06228E01	ML16228E01	28.5	5	10	63	10
ML06228E02	ML16228E02	28.5	6	10	63	10
ML06228E03	ML16228E03	28.5	7	10	63	10
ML06228E04	ML16228E04	28.5	8	10	63	10
ML06228E05	ML16228E05	28.5	10	12	71	10
ML06232E01	ML16232E01	32.5	5	12	71	12
ML06232E02	ML16232E02	32.5	6	12	71	12
ML06232E03	ML16232E03	32.5	7	12	71	12
ML06232E04	ML16232E04	32.5	8	12	71	12
ML06232E05	ML16232E05	32.5	10	12	71	12
ML06238E01	ML16238E01	38.5	7	12	71	12
ML06238E02	ML16238E02	38.5	8	12	71	12
ML06238E03	ML16238E03	38.5	9	12	71	12
ML06238E04	ML16238E04	38.5	10	12	71	12
ML06245E01	ML16245E01	45.5	10	12	71	14

Tolerances according to DIN 7160 & 7161

	Nominal-Diameter in mm					
	from 1 to 3	over 3 to 6	over 6 to 10	over 10 to 18	over 18 to 30	over 30 to 80
js18	± 0.90	± 1.10	± 1.35	± 1.65	± 1.95	± 2.30
h11	0	0	0	0	0	0
e8	-14	-20	-25	-32	-40	-60
h6	0	0	0	0	0	0

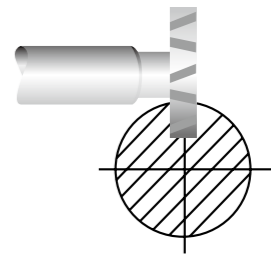

◎ : Excellent ○ : Good

ISO	P										M				K					
	Non-alloy steel					Low alloy steel					High alloyed steel, and tool steel		Stainless steel		Grey cast iron	Nodular cast iron		Malleable cast iron		
VDI 3323	1	2	3	4	5	6	7	8	9	10	11	12	13	14	15	16	17	18	19	20
HRc	13	25	28	32	35	38	40	42	45	48	50	52	55	58	60	62	65	68	70	72
HB	125	190	250	270	300	180	275	300	350	200	325	200	240	180	180	260	160	250	130	230
Recommended	◎	◎	◎	◎	◎	◎	◎	◎	◎	◎	◎	◎	◎	◎	◎	◎	◎	◎	◎	◎



PLAIN SHANK **ML072** SERIES

FLAT SHANK **ML172** SERIES

HSS-E, T-SLOT CUTTERS TYPE "AA", "AB", "AD"

- HSS-E, SCHAFERFRÄSER FÜR T-NUTEN FORM "AA", "AB", "AD"
- Fraise HSS-E pour rainure en "T" Type "AA", "AB", "AD"
- FRESE PER SCANALATURE A T - DENTI ALTERNATI

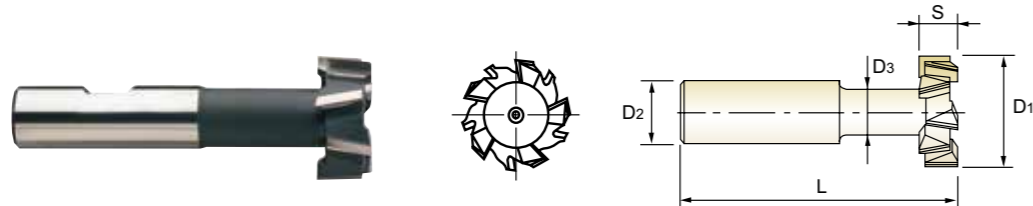

HSS-E DIN 851 N 10° DIN 1835A DIN 1835B UNCOATED p.C729

Unit : mm

EDP No.	Cutter Diameter	Width of Face	Shank Diameter	Neck Diameter	Overall Length	No. of Teeth	
							PLAIN
ML07212E01	ML17212E01	12.5	6	10	5	57	6
ML07201601	ML17201601	16.0	8	10	6.5	62	6
ML07201801	ML17201801	18.0	8	12	8	70	6
ML07201901	ML17201901	19.0	9	12	8	71	6
ML07202101	ML17202101	21.0	9	12	10	74	6
ML07202201	ML17202201	22.0	10	12	10	75	6
ML07202501	ML17202501	25.0	11	16	12	82	6
ML07202801	ML17202801	28.0	12	16	13	83	6
ML07203201	ML17203201	32.0	14	16	15	90	8
ML07203601	ML17203601	36.0	16	25	17	103	8
ML07204001	ML17204001	40.0	18	25	19	108	8

Tolerances according to DIN 7160 & 7161

	Nominal-Diameter in mm						
	over3 to 6	over6 to 10	over10 to 18	over18 to 30	over30 to 50	over50 to 80	over80 to 120
Tolerance range in mm							
h12	0 -0.12	0 -0.15	0 -0.18	0 -0.21	0 -0.25	0 -0.30	0 -0.35
js18	± 0.90	± 1.10	± 1.35	± 1.65	± 1.95	± 2.30	± 2.70
Tolerance range in μm							
d11	-30 -105	-40 -130	-50 -160	-65 -195	-80 -240	-100 -290	-120 -340
h6	0 -8	0 -9	0 -11	0 -13	0 -16	0 -19	0 -22

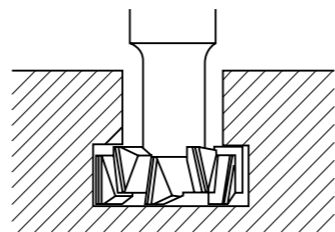

◎ : Excellent ○ : Good

ISO	P										M				K					
	Non-alloy steel					Low alloy steel					High alloyed steel, and tool steel		Stainless steel		Grey cast iron		Nodular cast iron		Malleable cast iron	
Material Description	1	2	3	4	5	6	7	8	9	10	11	12	13	14	15	16	17	18	19	20
VDI 3323	1	2	3	4	5	6	7	8	9	10	11	12	13	14	15	16	17	18	19	20
HRc	13	25	28	32	35	38	42	45	48	52	55	58	60	62	65	68	70	72	74	76
HB	125	190	250	270	300	180	275	300	350	200	325	200	240	180	180	260	160	250	130	230
Recommended	◎	◎	◎	◎	◎	◎	◎	◎	◎	◎	◎	◎	◎	◎	◎	◎	◎	◎	◎	◎



STRAIGHT TEETH **ML092** SERIES

HSS-E, SIDE AND FACE MILLING CUTTERS with STRAIGHT TEETH

- HSS-E, SCHEIBENFRÄSER mit GERADEVERZAHNT
- Fraise HSS-E 3 Tailles, denture droite
- FRESE A DISCO A TRE TAGLI - DENTI DRITTI

▶ The tools are used for general purpose side and straddle milling where deep cut is not required.

▶ Diese Werkzeuge werden bei allgemeinen Seiten-und Breitfräsen eingesetzt, wo Tiefschnitte nicht vorkommen.

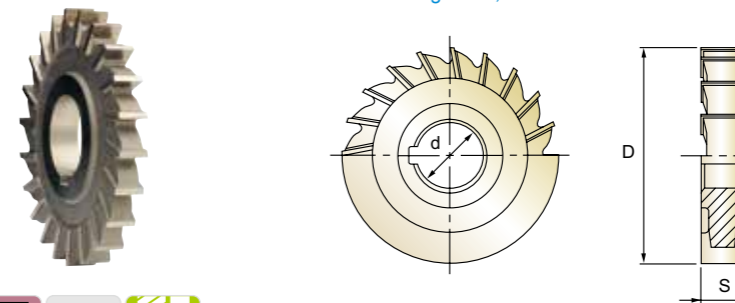

HSS-E DIN 885-B H UNCOATED p.C730

Unit : mm

EDP No.	Cutter Diameter	Width of Face	Internal Diameter	No. of Teeth
ML09205001	50.0	4	16	18
ML09205002	50.0	5	16	18
ML09205003	50.0	6	16	18
ML09205004	50.0	8	16	16
ML09205005	50.0	10	16	16
ML09206301	63.0	5	22	22
ML09206302	63.0	6	22	22
ML09206303	63.0	8	22	20
ML09206304	63.0	10	22	20
ML09206305	63.0	12	22	20
ML09208001	80.0	6	22	24
ML09208002	80.0	8	22	24
ML09208003	80.0	10	22	24
ML09208004	80.0	12	22	20
ML09208005	80.0	6	27	24
ML09208006	80.0	8	27	24
ML09208007	80.0	10	27	24
ML09208008	80.0	12	27	20
ML09210001	100.0	6	27	26
ML09210002	100.0	8	27	26

Tolerances according to DIN 7160 & 7161

	Nominal-Diameter in mm							
	over3 to 6	over6 to 10	over10 to 18	over18 to 30	over30 to 50	over50 to 80	over80 to 120	over120 to 180
Tolerance range in mm								
js14	± 0.15	± 0.18	± 0.215	± 0.26	± 0.31	± 0.37	± 0.435	± 0.50
Tolerance range in μm								
k11	+75 0	+90 0	+110 0	+130 0	+160 0	+190 0	+220 0	+250 0
H7	+12 0	+15 0	+18 0	+21 0	+25 0	+30 0	+35 0	+40 0

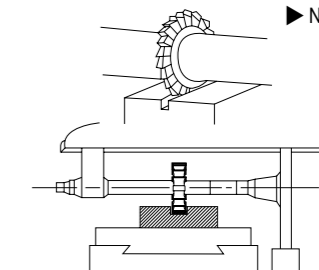

◎ : Excellent ○ : Good

ISO	P										M				K					
	Non-alloy steel					Low alloy steel					High alloyed steel, and tool steel		Stainless steel		Grey cast iron		Nodular cast iron		Malleable cast iron	
Material Description	1	2	3	4	5	6	7	8	9	10	11	12	13	14	15	16	17	18	19	20
VDI 3323	1	2	3	4	5	6	7	8	9	10	11	12	13	14	15	16	17	18	19	20
HRc	13	25	28	32	35	38	42	45	48	52	55	58	60	62	65	68	70	72	74	76
HB	125	190	250	270	300	180	275	300	350	200	325	200	240	180	180	260	160	250	130	230
Recommended	◎	◎	◎	◎	◎	◎	◎	◎	◎	◎	◎	◎	◎	◎	◎	◎	◎	◎	◎	◎

HSS-E, SIDE AND FACE MILLING CUTTERS with STRAIGHT TEETH

- HSS-E, SCHEIBENFRÄSER mit GERADEVERZAHNT
- Fraise HSS-E 3 Tailles, denture droite
- FRESE A DISCO A TRE TAGLI - DENTI DRITTI

▶ The tools are used for general purpose side and straddle milling where deep cut is not required. ▶ Diese Werkzeuge werden bei allgemeinen Seiten-und Breitfräsen eingesetzt, wo Tiefschnitte nicht vorkommen.

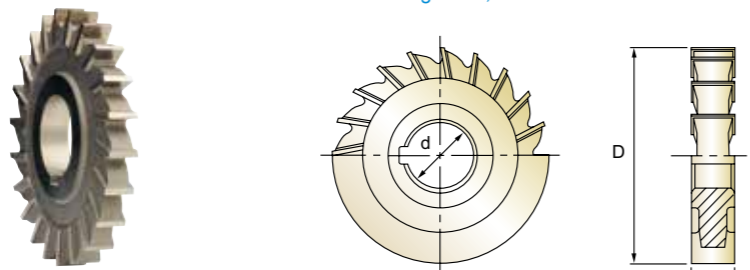

Unit : mm

EDP No.	Cutter Diameter	Width of Face	Internal Diameter	No. of Teeth
	D(js14)	S(k11)	d(H7)	Z
ML09210003	100.0	10	27	22
ML09210004	100.0	6	32	26
ML09210005	100.0	8	32	26
ML09210006	100.0	10	32	22
ML09210007	100.0	12	32	22
ML09212501	125.0	8	32	30
ML09212502	125.0	10	32	30
ML09212503	125.0	12	32	24

Tolerances according to DIN 7160 & 7161

	Nominal-Diameter in mm							
	over3to6	over6to10	over10to18	over18to30	over30to50	over50to80	over80to120	over120to180
Tolerance range in mm								
js14	± 0.15	± 0.18	± 0.215	± 0.26	± 0.31	± 0.37	± 0.435	± 0.50
Tolerance range in µm								
k11	+75 0	+90 0	+110 0	+130 0	+160 0	+190 0	+220 0	+250 0
H7	+12 0	+15 0	+18 0	+21 0	+25 0	+30 0	+35 0	+40 0

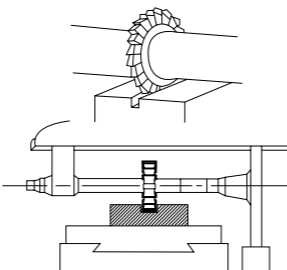

◎ : Excellent ○ : Good

ISO	P										M				K					
	Non-alloy steel					Low alloy steel					High alloyed steel, and tool steel		Stainless steel		Grey cast iron	Nodular cast iron		Malleable cast iron		
Material Description	1	2	3	4	5	6	7	8	9	10	11	12	13	14	15	16	17	18	19	20
VDI 3323	1	2	3	4	5	6	7	8	9	10	11	12	13	14	15	16	17	18	19	20
HRc	13	25	28	32	38	42	48	52	58	62	68	72	78	82	88	92	98	102	108	112
HB	125	190	250	270	300	180	275	300	350	200	325	200	240	180	180	260	160	250	130	230
Recommended	◎	◎	◎	◎	◎	◎	◎	◎	◎	◎	◎	◎	◎	◎	◎	◎	◎	◎	◎	◎

HSS-E, SIDE AND FACE MILLING CUTTERS with STAGGERED TEETH

- HSS-E, SCHEIBENFRÄSER mit KREUZVERZAHNT
- Fraise HSS-E 3 Tailles, denture alternée
- FRESE A DISCO A TRE TAGLI - DENTI ALTERNATI

▶ The type of cutter is recommended for slotting operations. The alternate spiral effectively counteracts all tendency to chatter. ▶ Dieser Typ ist zum Schlitzfräsen geeignet. Das alternierende Spiral wirkt allen Schnatterbewegungen entgegen.

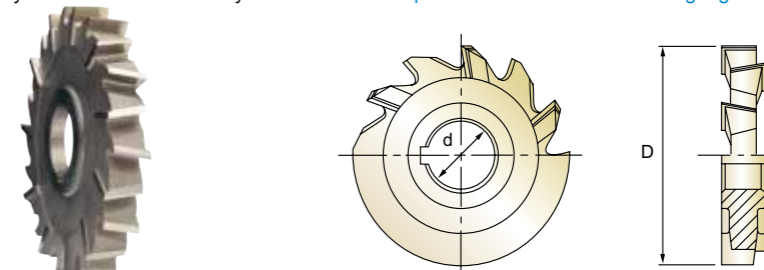

Unit : mm

EDP No.	Cutter Diameter	Width of Face	Internal Diameter	No. of Teeth
	D(js14)	S(k11)	d(H7)	Z
ML10205001	50.0	3	16	14
ML10205002	50.0	4	16	14
ML10205003	50.0	5	16	14
ML10205004	50.0	6	16	14
ML10205005	50.0	7	16	14
ML10205006	50.0	8	16	14
ML10205007	50.0	9	16	14
ML10205008	50.0	10	16	14
ML10206301	63.0	3	22	16
ML10206302	63.0	4	22	16
ML10206303	63.0	5	22	16
ML10206304	63.0	6	22	16
ML10206305	63.0	7	22	16
ML10206306	63.0	8	22	16
ML10206307	63.0	9	22	16
ML10206308	63.0	10	22	16
ML10206309	63.0	12	22	16
ML10206310	63.0	14	22	16
ML10206311	63.0	16	22	16
ML10206312	63.0	18	22	16

Tolerances according to DIN 7160 & 7161

	Nominal-Diameter in mm								
	over3to6	over6to10	over10to18	over18to30	over30to50	over50to80	over80to120	over120to180	over180to250
Tolerance range in mm									
js14	± 0.15	± 0.18	± 0.215	± 0.26	± 0.31	± 0.37	± 0.435	± 0.50	± 0.575
Tolerance range in µm									
k11	+75 0	+90 0	+110 0	+130 0	+160 0	+190 0	+220 0	+250 0	+290 0
H7	+12 0	+15 0	+18 0	+21 0	+25 0	+30 0	+35 0	+40 0	+46 0

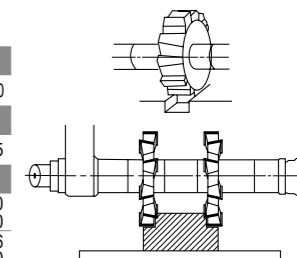

▶ NEXT PAGE

◎ : Excellent ○ : Good

ISO	P										M				K					
	Non-alloy steel					Low alloy steel					High alloyed steel, and tool steel		Stainless steel		Grey cast iron	Nodular cast iron		Malleable cast iron		
Material Description	1	2	3	4	5	6	7	8	9	10	11	12	13	14	15	16	17	18	19	20
VDI 3323	1	2	3	4	5	6	7	8	9	10	11	12	13	14	15	16	17	18	19	20
HRc	13	25	28	32	38	42	48	52	58	62	68	72	78	82	88	92	98	102	108	112
HB	125	190	250	270	300	180	275	300	350	200	325	200	240	180	180	260	160	250	130	230
Recommended	◎	◎	◎	◎	◎	◎	◎	◎	◎	◎	◎	◎	◎	◎	◎	◎	◎	◎	◎	◎

HSS-E, SIDE AND FACE MILLING CUTTERS with STAGGERED TEETH

- HSS-E, SCHEIBENFRÄSER mit KREUZVERZAHNT
- Fraise HSS-E 3 Tailles, denture alternée
- FRESE A DISCO A TRE TAGLI - DENTI ALTERNATI

▶ The type of cutter is recommended for slotting operations. The alternate spiral effectively counteracts all tendency to chatter.
 ▶ Dieser Typ ist zum Schlitzfräsen geeignet. Das alternierende Spiral wirkt allen Schnatterbewegungen entgegen.

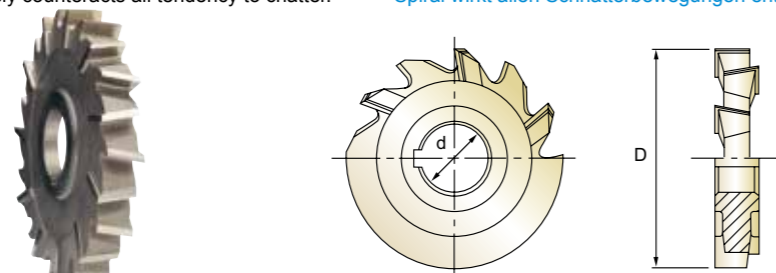

Unit : mm

EDP No.	Cutter Diameter	Width of Face	Internal Diameter	No. of Teeth
	D(js14)	S(k11)	d(H7)	Z
ML10208001	80.0	3	22	18
ML10208002	80.0	4	22	18
ML10208003	80.0	5	22	18
ML10208004	80.0	6	22	18
ML10208005	80.0	7	22	18
ML10208006	80.0	8	22	18
ML10208007	80.0	9	22	18
ML10208008	80.0	10	22	18
ML10208009	80.0	12	22	18
ML10208010	80.0	14	22	18
ML10208011	80.0	16	22	18
ML10208012	80.0	18	22	18
ML10208013	80.0	20	22	18
ML10208014	80.0	4	27	18
ML10208015	80.0	5	27	18
ML10208016	80.0	6	27	18
ML10208017	80.0	7	27	18
ML10208018	80.0	8	27	18
ML10208019	80.0	9	27	18
ML10208020	80.0	10	27	18

Tolerances according to DIN 7160 & 7161

	Nominal-Diameter in mm								
	over 3 to 6	over 6 to 10	over 10 to 18	over 18 to 30	over 30 to 50	over 50 to 80	over 80 to 120	over 120 to 180	over 180 to 250
Tolerance range in mm									
js14	± 0.15	± 0.18	± 0.215	± 0.26	± 0.31	± 0.37	± 0.435	± 0.50	± 0.575
Tolerance range in μm									
k11	+75 0	+90 0	+110 0	+130 0	+160 0	+190 0	+220 0	+250 0	+290 0
H7	+12 0	+15 0	+18 0	+21 0	+25 0	+30 0	+35 0	+40 0	+46 0

◎ : Excellent ○ : Good

ISO	P										M				K					
	Non-alloy steel					Low alloy steel					High alloyed steel, and tool steel		Stainless steel		Grey cast iron	Nodular cast iron		Malleable cast iron		
Material Description	1	2	3	4	5	6	7	8	9	10	11	12	13	14	15	16	17	18	19	20
VDI 3323	1	2	3	4	5	6	7	8	9	10	11	12	13	14	15	16	17	18	19	20
HRc	13	25	28	32	32	32	32	32	32	32	32	32	32	32	32	32	32	32	32	32
HB	125	190	250	270	300	180	275	300	350	200	325	200	240	180	180	260	160	250	130	230
Recommended	◎	◎	◎	◎	◎	◎	◎	◎	◎	◎	◎	◎	◎	◎	◎	◎	◎	◎	◎	◎

HSS-E, SIDE AND FACE MILLING CUTTERS with STAGGERED TEETH

- HSS-E, SCHEIBENFRÄSER mit KREUZVERZAHNT
- Fraise HSS-E 3 Tailles, denture alternée
- FRESE A DISCO A TRE TAGLI - DENTI ALTERNATI

▶ The type of cutter is recommended for slotting operations. The alternate spiral effectively counteracts all tendency to chatter.
 ▶ Dieser Typ ist zum Schlitzfräsen geeignet. Das alternierende Spiral wirkt allen Schnatterbewegungen entgegen.

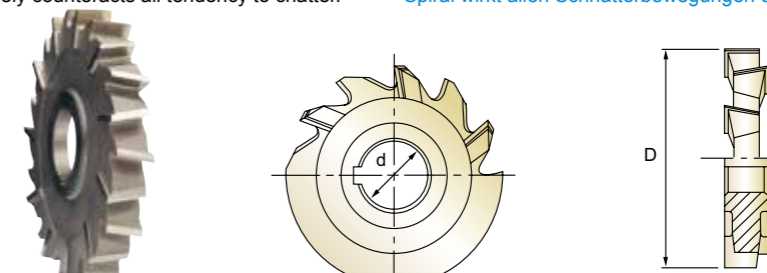

Unit : mm

EDP No.	Cutter Diameter	Width of Face	Internal Diameter	No. of Teeth
	D(js14)	S(k11)	d(H7)	Z
ML10208021	80.0	12	27	18
ML10208022	80.0	14	27	18
ML10208023	80.0	16	27	18
ML10208024	80.0	18	27	18
ML10208025	80.0	20	27	18
ML10210001	100.0	3	27	20
ML10210002	100.0	4	27	20
ML10210003	100.0	5	27	20
ML10210004	100.0	6	27	20
ML10210005	100.0	7	27	20
ML10210006	100.0	8	27	20
ML10210007	100.0	9	27	20
ML10210008	100.0	10	27	20
ML10210009	100.0	12	27	20
ML10210010	100.0	14	27	20
ML10210011	100.0	15	27	20
ML10210012	100.0	16	27	20
ML10210013	100.0	18	27	20
ML10210014	100.0	20	27	20
ML10210015	100.0	4	32	20

Tolerances according to DIN 7160 & 7161

	Nominal-Diameter in mm								
	over 3 to 6	over 6 to 10	over 10 to 18	over 18 to 30	over 30 to 50	over 50 to 80	over 80 to 120	over 120 to 180	over 180 to 250
Tolerance range in mm									
js14	± 0.15	± 0.18	± 0.215	± 0.26	± 0.31	± 0.37	± 0.435	± 0.50	± 0.575
Tolerance range in μm									
k11	+75 0	+90 0	+110 0	+130 0	+160 0	+190 0	+220 0	+250 0	+290 0
H7	+12 0	+15 0	+18 0	+21 0	+25 0	+30 0	+35 0	+40 0	+46 0

◎ : Excellent ○ : Good

ISO	P										M				K					
	Non-alloy steel					Low alloy steel					High alloyed steel, and tool steel		Stainless steel		Grey cast iron	Nodular cast iron		Malleable cast iron		
Material Description	1	2	3	4	5	6	7	8	9	10	11	12	13	14	15	16	17	18	19	20
VDI 3323	1	2	3	4	5	6	7	8	9	10	11	12	13	14	15	16	17	18	19	20
HRc	13	25	28	32	32	32	32	32	32	32	32	32	32	32	32	32	32	32	32	32
HB	125	190	250	270	300	180	275	300	350	200	325	200	240	180	180	260	160	250	130	230
Recommended	◎	◎	◎	◎	◎	◎	◎	◎	◎	◎	◎	◎	◎	◎	◎	◎	◎	◎	◎	◎



STAGGERED TEETH **ML102** SERIES

HSS-E, SIDE AND FACE MILLING CUTTERS with STAGGERED TEETH

- HSS-E, SCHEIBENFRÄSER mit KREUZVERZAHNT
- Fraise HSS-E 3 Tailles, denture alternée
- FRESE A DISCO A TRE TAGLI - DENTI ALTERNATI

▶ The type of cutter is recommended for slotting operations. The alternate spiral effectively counteracts all tendency to chatter.

▶ Dieser Typ ist zum Schlitzfräsen geeignet. Das alternierende Spiral wirkt allen Schnatterbewegungen entgegen.

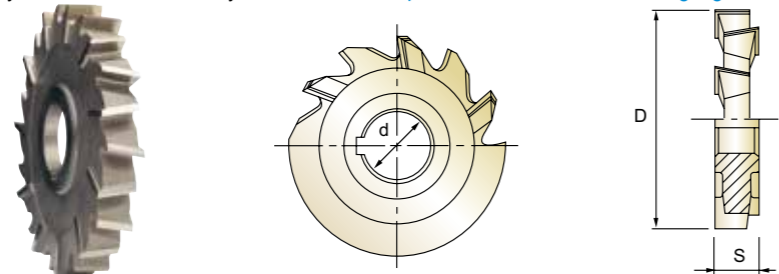

Unit : mm

EDP No.	Cutter Diameter	Width of Face	Internal Diameter	No. of Teeth
	D(js14)	S(k11)	d(H7)	Z
ML10210016	100.0	5	32	20
ML10210017	100.0	6	32	20
ML10210018	100.0	7	32	20
ML10210019	100.0	8	32	20
ML10210020	100.0	9	32	20
ML10210021	100.0	10	32	20
ML10210022	100.0	12	32	20
ML10210023	100.0	14	32	20
ML10210024	100.0	15	32	20
ML10210025	100.0	16	32	20
ML10210026	100.0	18	32	20
ML10210027	100.0	20	32	20
ML10212501	125.0	5	32	22
ML10212502	125.0	6	32	22
ML10212503	125.0	8	32	22
ML10212504	125.0	10	32	22
ML10212505	125.0	12	32	22
ML10212506	125.0	14	32	22
ML10212507	125.0	16	32	22
ML10212508	125.0	18	32	22

Tolerances according to DIN 7160 & 7161

	Nominal-Diameter in mm								
	over3to6	over6to10	over10to18	over18to30	over30to50	over50to80	over80to120	over120to180	over180to250
Tolerance range in mm									
js14	±0.15	±0.18	±0.215	±0.26	±0.31	±0.37	±0.435	±0.50	±0.575
Tolerance range in μm									
k11	+75 0	+90 0	+110 0	+130 0	+160 0	+190 0	+220 0	+250 0	+290 0
H7	+12 0	+15 0	+18 0	+21 0	+25 0	+30 0	+35 0	+40 0	+46 0

◎ : Excellent ○ : Good

ISO	P														M				K																								
	Non-alloy steel					Low alloy steel					High alloyed steel, and tool steel				Stainless steel		Grey cast iron	Nodular cast iron		Malleable cast iron																							
Material Description	1	2	3	4	5	6	7	8	9	10	11	12	13	14	15	16	17	18	19	20	21	22	23	24	25	26	27	28	29	30	31	32	33	34	35	36	37	38	39	40	41		
VDI 3323	1	2	3	4	5	6	7	8	9	10	11	12	13	14	15	16	17	18	19	20	21	22	23	24	25	26	27	28	29	30	31	32	33	34	35	36	37	38	39	40	41		
HRc	13	13	25	28	32	10	29	32	38	15	35	15	23	10	10	26	3	25	21	21	10	10	10	10	10	10	10	10	10	10	10	10	10	10	10	10	10	10	10	10	10	10	
HB	125	190	250	270	300	180	275	300	350	200	325	200	240	180	180	260	160	250	130	230	180	180	180	180	180	180	180	180	180	180	180	180	180	180	180	180	180	180	180	180	180	180	
Recommended	◎	◎	◎	◎	◎	◎	◎	◎	◎	◎	◎	◎	◎	◎	◎	◎	◎	◎	◎	◎	◎	◎	◎	◎	◎	◎	◎	◎	◎	◎	◎	◎	◎	◎	◎	◎	◎	◎	◎	◎	◎	◎	◎



STAGGERED TEETH **ML102** SERIES

HSS-E, SIDE AND FACE MILLING CUTTERS with STAGGERED TEETH

- HSS-E, SCHEIBENFRÄSER mit KREUZVERZAHNT
- Fraise HSS-E 3 Tailles, denture alternée
- FRESE A DISCO A TRE TAGLI - DENTI ALTERNATI

▶ The type of cutter is recommended for slotting operations. The alternate spiral effectively counteracts all tendency to chatter.

▶ Dieser Typ ist zum Schlitzfräsen geeignet. Das alternierende Spiral wirkt allen Schnatterbewegungen entgegen.

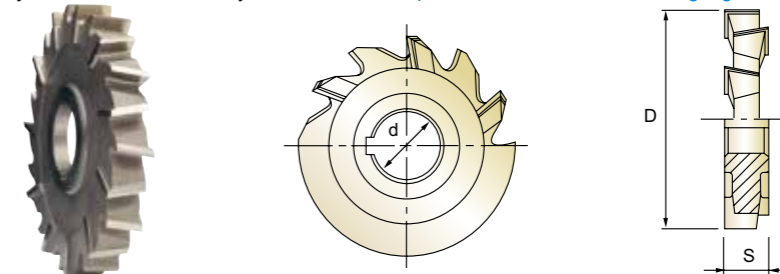

Unit : mm

EDP No.	Cutter Diameter	Width of Face	Internal Diameter	No. of Teeth
	D(js14)	S(k11)	d(H7)	Z
ML10212509	125.0	20	32	22
ML10216001	160.0	6	32	26
ML10216002	160.0	8	32	26
ML10216003	160.0	10	32	26
ML10216004	160.0	12	32	26
ML10216005	160.0	14	32	26
ML10216006	160.0	16	32	26
ML10216007	160.0	18	32	26
ML10216008	160.0	20	32	26
ML10216009	160.0	6	40	26
ML10216010	160.0	8	40	26
ML10216011	160.0	10	40	26
ML10216012	160.0	12	40	26
ML10216013	160.0	14	40	26
ML10216014	160.0	16	40	26
ML10216015	160.0	18	40	26
ML10216016	160.0	20	40	26
ML10220001	200.0	10	40	30
ML10220002	200.0	12	40	30
ML10220003	200.0	14	40	30

Tolerances according to DIN 7160 & 7161

	Nominal-Diameter in mm								
	over3to6	over6to10	over10to18	over18to30	over30to50	over50to80	over80to120	over120to180	over180to250
Tolerance range in mm									
js14	±0.15	±0.18	±0.215	±0.26	±0.31	±0.37	±0.435	±0.50	±0.575
Tolerance range in μm									
k11	+75 0	+90 0	+110 0	+130 0	+160 0	+190 0	+220 0	+250 0	+290 0
H7	+12 0	+15 0	+18 0	+21 0	+25 0	+30 0	+35 0	+40 0	+46 0

◎ : Excellent ○ : Good

ISO	P														M				K																								
	Non-alloy steel					Low alloy steel					High alloyed steel, and tool steel				Stainless steel		Grey cast iron	Nodular cast iron		Malleable cast iron																							
Material Description	1	2	3	4	5	6	7	8	9	10	11	12	13	14	15	16	17	18	19	20	21	22	23	24	25	26	27	28	29	30	31	32	33	34	35	36	37	38	39	40	41		
VDI 3323	1	2	3	4	5	6	7	8	9	10	11	12	13	14	15	16	17	18	19	20	21	22	23	24	25	26	27	28	29	30	31	32	33	34	35	36	37	38	39	40	41		
HRc	13	13	25	28	32	10	29	32	38	15	35	15	23	10	10	26	3	25	21	21	10	10	10	10	10	10	10	10	10	10	10	10	10	10	10	10	10	10	10	10	10	10	
HB	125	190	250	270	300	180	275	300	350	200	325	200	240	180	180	260	160	250	130	230	180	180	180	180	180	180	180	180	180	180	180	180	180	180	180	180	180	180	180	180	180	180	
Recommended	◎	◎	◎	◎	◎	◎	◎	◎	◎	◎	◎	◎	◎	◎	◎	◎	◎	◎	◎	◎	◎	◎	◎	◎	◎	◎	◎	◎	◎	◎	◎	◎	◎	◎	◎	◎	◎	◎	◎	◎	◎	◎	◎



STAGGERED TEETH **ML102** SERIES

HSS-E, SIDE AND FACE MILLING CUTTERS with STAGGERED TEETH

- HSS-E, SCHEIBENFRÄSER mit KREUZVERZAHNT
- Fraise HSS-E 3 Tailles, denture alternée
- FRESE A DISCO A TRE TAGLI - DENTI ALTERNATI

▶ The type of cutter is recommended for slotting operations. The alternate spiral effectively counteracts all tendency to chatter.
 ▶ Dieser Typ ist zum Schlitzfräsen geeignet. Das alternierende Spiral wirkt allen Schnatterbewegungen entgegen.

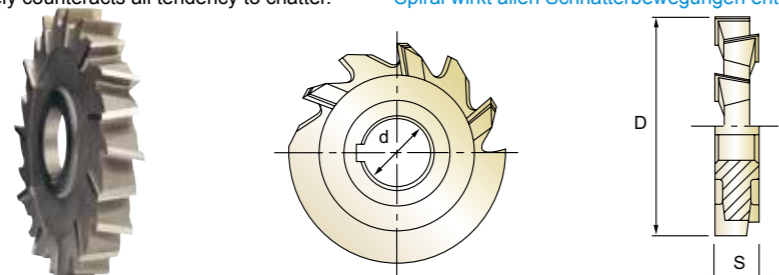

HSS-E DIN 885-A H UNCOATED p.C731

EDP No.	Cutter Diameter	Width of Face	Internal Diameter	No. of Teeth
ML10220004	200.0	16	40	30
ML10220005	200.0	18	40	30
ML10220006	200.0	20	40	30
ML10220007	200.0	22	40	30
ML10220008	200.0	25	40	30

Tolerances according to DIN 7160 & 7161

	Nominal-Diameter in mm								
	over 3 to 6	over 6 to 10	over 10 to 18	over 18 to 30	over 30 to 50	over 50 to 80	over 80 to 120	over 120 to 180	over 180 to 250
Tolerance range in mm									
js14	± 0.15	± 0.18	± 0.215	± 0.26	± 0.31	± 0.37	± 0.435	± 0.50	± 0.575
Tolerance range in μm									
k11	+75 0	+90 0	+110 0	+130 0	+160 0	+190 0	+220 0	+250 0	+290 0
H7	+12 0	+15 0	+18 0	+21 0	+25 0	+30 0	+35 0	+40 0	+46 0

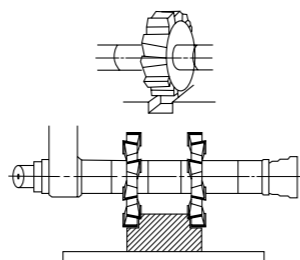

◎ : Excellent ○ : Good

ISO	P										M				K						
	Non-alloy steel					Low alloy steel					High alloyed steel, and tool steel				Stainless steel		Grey cast iron		Nodular cast iron		Malleable cast iron
Material Description	1	2	3	4	5	6	7	8	9	10	11	12	13	14	15	16	17	18	19	20	
VDI 3323	1	2	3	4	5	6	7	8	9	10	11	12	13	14	15	16	17	18	19	20	
HRc	13	25	28	32	38	42	48	52	58	62	68	72	78	82	88	92	98	102	108	112	
HB	125	190	250	270	300	180	275	300	350	200	325	200	240	180	180	260	160	250	130	230	
Recommended	◎	◎	◎	◎	◎	◎	◎	◎	◎	◎	◎	◎	◎	◎	◎	◎	◎	◎	◎	◎	

ISO	N										S				H						
	Aluminum-wrought alloy		Aluminum-cast, alloyed		Copper and Copper Alloys (Bronze / Brass)		Non Metallic Materials		Heat Resistant Super Alloys				Titanium Alloys		Hardened steel		Chilled Cast Iron		Hardened Cast Iron		
Material Description	21	22	23	24	25	26	27	28	29	30	31	32	33	34	35	36	37	38	39	40	41
VDI 3323	21	22	23	24	25	26	27	28	29	30	31	32	33	34	35	36	37	38	39	40	41
HRc	21	22	23	24	25	26	27	28	29	30	31	32	33	34	35	36	37	38	39	40	41
HB	60	100	75	90	130	110	90	100			200	280	250	350	320	400 Rm	1050 Rm	550	630	400	550
Recommended	◎	◎	◎	◎	◎	◎	◎	◎	◎	◎	◎	◎	◎	◎	◎	◎	◎	◎	◎	◎	◎



E2675 SERIES

HSSCo8, MULTI FLUTE SHELL END MILL

- HSSCo8, MULTI SCHNEIDEN WALZENSTIRNFRÄSER
- Fraise HSSCo8, multi-dents trou lisse
- FRESA CILINDRICA FRONTALE, MULTI TAGLIENTE

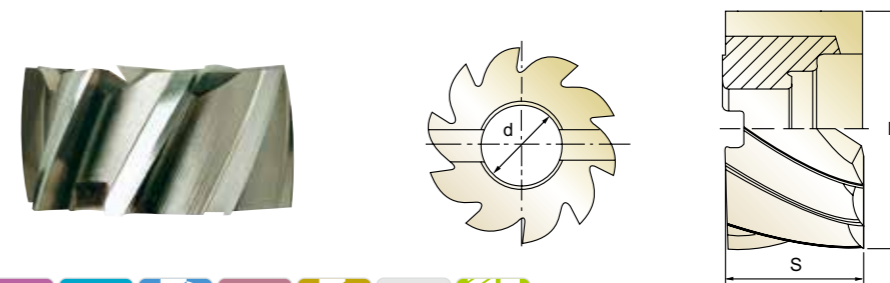

HSS Co8 DIN 841 N 6-10 30° UNCOATED p.C732

EDP No.	Mill Diameter	Width of Face	Internal Diameter	No. of Teeth
E2675300	30.0	30	● 13	6
E2675350	35.0	35	● 16	6
E2675400	40.0	20	● 16	8
E2675402	40.0	40	● 16	8
E2675500	50.0	25	22	8
E2675502	50.0	50	22	8
E2675600	60.0	30	27	8
E2675601	60.0	60	27	8
E2675750	75.0	35	27	10
E2675751	75.0	75	27	10
E2675900	90.0	35	27	10
E2675902	110.0	35	32	10

● Tolerance of Internal Diameter = +0.018 ~ 0
▶ TIN-COATING, TICN-COATING & TiAIN-COATING is available on your request.

HSS Co8 DIN 1880 N 8-14 30° UNCOATED p.C732

EDP No.	Mill Diameter	Width of Face	Internal Diameter	No. of Teeth
E2675401	40.0	32	● 16	8
E2675501	50.0	36	22	8
E2675630	63.0	40	27	8
E2675800	80.0	45	27	10
E2675901	100.0	50	32	10
E2675903	125.0	56	40	12
E2675904	160.0	63	50	14

● Tolerance of Internal Diameter = +0.018 ~ 0
▶ TIN-COATING, TICN-COATING & TiAIN-COATING is available on your request.

Mill Dia. Tolerance(mm)	Width of Face Tolerance(mm)	Internal Dia. Tolerance(mm)
+ 0.25 - 0.15	+ 0.5 - 0	+ 0.02 - 0

◎ : Excellent ○ : Good

ISO	P										M				K						
	Non-alloy steel					Low alloy steel					High alloyed steel, and tool steel				Stainless steel		Grey cast iron		Nodular cast iron		Malleable cast iron
Material Description	1	2	3	4	5	6	7	8	9	10	11	12	13	14	15	16	17	18	19	20	
VDI 3323	1	2	3	4	5	6	7	8	9	10	11	12	13	14	15	16	17	18	19	20	
HRc	13	25	28	32	38	42	48	52	58	62	68	72	78	82	88	92	98	102	108	112	
HB	125	190	250	270	300	180	275	300	350	200	325	200	240	180	180	260	160	250	130	230	
Recommended	◎	◎	◎	◎	◎	◎	◎	◎	◎	◎	◎	◎	◎	◎	◎	◎	◎	◎	◎	◎	

ISO	N										S				H						
	Aluminum-wrought alloy		Aluminum-cast, alloyed		Copper and Copper Alloys (Bronze / Brass)		Non Metallic Materials		Heat Resistant Super Alloys				Titanium Alloys		Hardened steel		Chilled Cast Iron		Hardened Cast Iron		
Material Description	21	22	23	24	25	26	27	28	29	30	31	32	33	34	35	36	37	38	39	40	41
VDI 3323	21	22	23	24	25	26	27	28	29	30	31	32	33	34	35	36	37	38	39	40	41
HRc	21	22	23	24	25	26	27	28	29	30	31	32	33	34	35	36	37	38	39	40	41
HB	60	100	75	90	130	110	90	100			200	280	250	350	320	400 Rm	1050 Rm	550	630	400	550
Recommended	◎	◎	◎	◎	◎	◎	◎	◎	◎	◎	◎	◎	◎	◎	◎	◎	◎	◎	◎	◎	◎



E2676 SERIES

HSSCo8, MULTI FLUTE SHELL END MILL for ALUMINIUM

- HSSCo8, MULTI SCHNEIDEN WALZENSTIRNFRÄSER für ALUMINIUM
- Fraise HSSCo8, multi-dents trou lisse pour aluminium
- FRESA CILINDRICA FRONTALE MULTI TAGLIENTE, PER ALLUMINIO

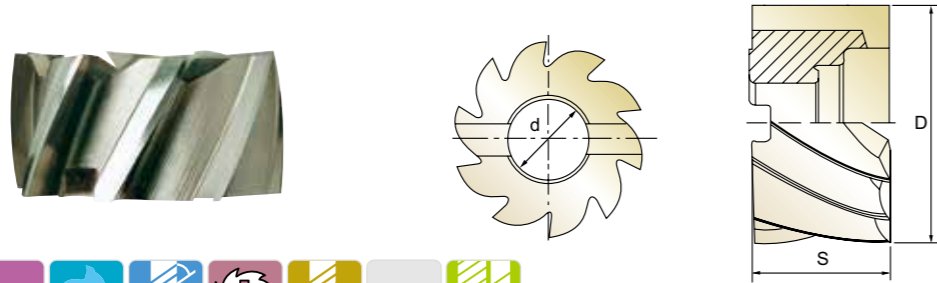

HSS Co8 DIN 841 W 4&6 42° UNCOATED p.C732

Unit : mm

EDP No.	Mill Diameter	Width of Face	Internal Diameter	No. of Teeth
	D	S	d	
E2676300	30.0	30	● 13	4
E2676400	40.0	20	● 16	4
E2676402	40.0	40	● 16	4
E2676500	50.0	25	22	6
E2676502	50.0	50	22	6
E2676600	60.0	30	27	6
E2676601	60.0	60	27	6
E2676750	75.0	75	27	6

- Tolerance of Internal Diameter = +0.018 ~ 0
- ▶ TIN-COATING, TICN-COATING & TiAIN-COATING is available on your request.

HSS Co8 DIN 1880 W 4&6 42° UNCOATED p.C732

Unit : mm

EDP No.	Mill Diameter	Width of Face	Internal Diameter	No. of Teeth
	D	S	d	
E2676401	40.0	32	● 16	4
E2676501	50.0	36	22	6
E2676630	63.0	40	27	6
E2676800	80.0	45	27	6
E2676901	100.0	50	32	6

- Tolerance of Internal Diameter = +0.018 ~ 0
- ▶ TIN-COATING, TICN-COATING & TiAIN-COATING is available on your request.

Mill Dia. Tolerance(mm)	Width of Face Tolerance(mm)	Internal Dia. Tolerance(mm)
+ 0.25	+ 0.5	+ 0.02
- 0.15	- 0	- 0

◎ : Excellent ○ : Good

ISO Material Description	P										M				K					
	Non-alloy steel					Low alloy steel					High alloyed steel, and tool steel		Stainless steel		Grey cast iron		Nodular cast iron		Malleable cast iron	
VDI 3323	1	2	3	4	5	6	7	8	9	10	11	12	13	14	15	16	17	18	19	20
HRc	13	25	28	32	38	40	45	50	55	60	65	70	75	80	85	90	95	100	105	110
HB	125	190	250	270	300	180	275	300	350	200	325	200	240	180	180	260	160	250	130	230
Recommended	○	○	○	○	○	○	○	○	○	○	○	○	○	○	○	○	○	○	○	○



E2677 SERIES

HSSCo8, MULTI FLUTE ROUGHING SHELL END MILL - COARSE

- HSSCo8, MULTI SCHNEIDEN WALZENSTIRN-SCHRUPPFÄSER - GROBES
- Fraise HSSCo8, multi-dents trou lisse, ébauche, pas grossier
- FRESA CILINDRICA FRONTALE MULTI TAGLIENTE, PER SGROSSATURA

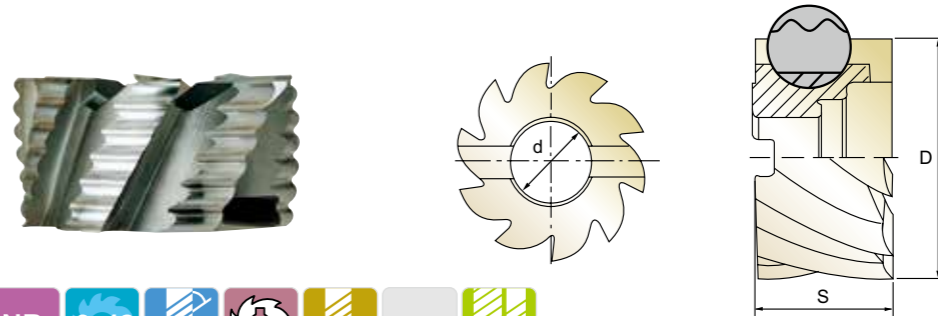

HSS Co8 DIN 841 NR 6-12 30° UNCOATED p.C733

Unit : mm

EDP No.	Mill Diameter	Width of Face	Internal Diameter	No. of Teeth
	D	S	d	
E2677401	40.0	40	● 16	6
E2677501	50.0	50	22	8
E2677600	60.0	30	27	8
E2677601	60.0	60	27	8
E2677750	75.0	35	27	10
E2677751	75.0	75	27	10
E2677900	90.0	35	27	10
E2677902	110.0	35	32	12

- Tolerance of Internal Diameter = +0.018 ~ 0
- ▶ TIN-COATING, TICN-COATING & TiAIN-COATING is available on your request.

HSS Co8 DIN 1880 NR 6-12 30° UNCOATED p.C733

Unit : mm

EDP No.	Mill Diameter	Width of Face	Internal Diameter	No. of Teeth
	D	S	d	
E2677400	40.0	32	● 16	6
E2677500	50.0	36	22	8
E2677630	63.0	40	27	8
E2677800	80.0	45	27	10
E2677901	100.0	50	32	10
E2677903	125.0	56	40	12
E2677904	160.0	63	50	12

- Tolerance of Internal Diameter = +0.018 ~ 0
- ▶ TIN-COATING, TICN-COATING & TiAIN-COATING is available on your request.

Mill Dia. Tolerance(mm)	Width of Face Tolerance(mm)	Internal Dia. Tolerance(mm)
+ 0.25	+ 0.5	+ 0.02
- 0.15	- 0	- 0

◎ : Excellent ○ : Good

ISO Material Description	P										M				K					
	Non-alloy steel					Low alloy steel					High alloyed steel, and tool steel		Stainless steel		Grey cast iron		Nodular cast iron		Malleable cast iron	
VDI 3323	1	2	3	4	5	6	7	8	9	10	11	12	13	14	15	16	17	18	19	20
HRc	13	25	28	32	38	40	45	50	55	60	65	70	75	80	85	90	95	100	105	110
HB	125	190	250	270	300	180	275	300	350	200	325	200	240	180	180	260	160	250	130	230
Recommended	◎	◎	◎	◎	◎	◎	◎	◎	◎	◎	◎	◎	◎	◎	◎	◎	◎	◎	◎	◎

HSSCo8, MULTI FLUTE ROUGHING SHELL END MILL - FINE

- HSSCo8, MULTI SCHNEIDEN WALZENSTIRN-SCHRUPPFRÄSER - FEINES
- Fraise HSSCo8, multi-dents trou lisse, ébauche, pas fin
- FRESA CILINDRICA FRONTALE MULTI TAGLIENTE, PER SGROSSATURA

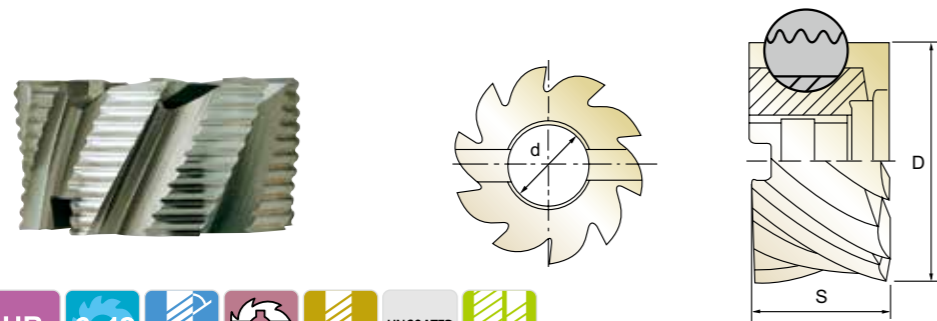

HSS Co8 DIN 841 HR 6-12 30° UNCOATED p.C733

Unit : mm

EDP No.	Mill Diameter	Width of Face	Internal Diameter	No. of Teeth
	D	S	d	
E2678401	40.0	40	● 16	6
E2678501	50.0	50	22	8
E2678600	60.0	30	27	8
E2678601	60.0	60	27	8
E2678750	75.0	35	27	10
E2678751	75.0	75	27	10
E2678900	90.0	35	27	10
E2678902	110.0	35	32	12

- Tolerance of Internal Diameter = +0.018 ~ 0
- ▶ TIN-COATING, TiCN-COATING & TiAIN-COATING is available on your request.

HSS Co8 DIN 1880 HR 6-12 30° UNCOATED p.C733

Unit : mm

EDP No.	Mill Diameter	Width of Face	Internal Diameter	No. of Teeth
	D	S	d	
E2678400	40.0	32	● 16	6
E2678500	50.0	36	22	8
E2678630	63.0	40	27	8
E2678800	80.0	45	27	10
E2678901	100.0	50	32	10
E2678903	125.0	56	40	12
E2678904	160.0	63	50	12

- Tolerance of Internal Diameter = +0.018 ~ 0
- ▶ TIN-COATING, TiCN-COATING & TiAIN-COATING is available on your request.

Mill Dia. Tolerance(mm)	Width of Face Tolerance(mm)	Internal Dia. Tolerance(mm)
+0.25 -0.15	+0.5 -0	+0.02 -0

◎ : Excellent ○ : Good

ISO Material Description	P										M				K					
	Non-alloy steel					Low alloy steel					High alloyed steel, and tool steel		Stainless steel		Grey cast iron	Nodular cast iron		Malleable cast iron		
VDI 3323	1	2	3	4	5	6	7	8	9	10	11	12	13	14	15	16	17	18	19	20
HRc	13	25	28	32	38	10	29	32	38	45	15	35	23	10	10	26	3	25	21	21
HB	125	190	250	270	300	180	275	300	350	200	325	200	240	180	180	260	160	250	130	230
Recommended	◎	◎	◎	◎	◎	◎	◎	◎	◎	◎	◎	◎	◎	◎	◎	◎	◎	◎	◎	◎

ISO Material Description	N										S					H					
	Aluminum-wrought alloy		Aluminum-cast, alloyed			Copper and Copper Alloys (Bronze / Brass)					Non Metallic Materials		Heat Resistant Super Alloys			Titanium Alloys	Hardened steel	Chilled Cast Iron	Hardened Cast Iron		
VDI 3323	21	22	23	24	25	26	27	28	29	30	31	32	33	34	35	36	37	38	39	40	41
HRc	15	30	25	38	34	15	30	25	38	34	200	280	250	350	320	400 Rm	1050 Rm	550	630	400	550
HB	60	100	75	90	130	110	90	100								400 Rm	1050 Rm	550	630	400	550
Recommended	◎	◎	◎	◎	◎	◎	◎	◎	◎	◎	◎	◎	◎	◎	◎	◎	◎	◎	◎	◎	◎

HSSCo8, MULTI FLUTE ROUGHING & FINISHING SHELL END MILL

- HSSCo8, MULTI SCHNEIDEN WALZENSTIRN-SCHRUPPSCHLICHTFRÄSER
- Fraise HSSCo8, multi-dents trou lisse, ébauche et finition
- FRESA CILINDRICA FRONTALE MULTI TAGLIENTE, SEMI FINITURA

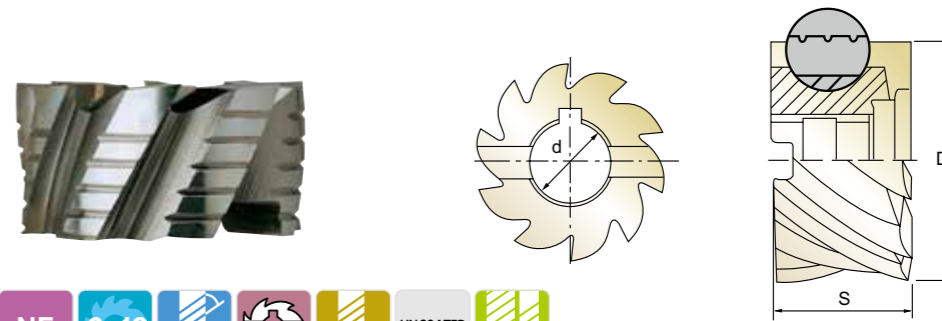

HSS Co8 DIN 841 NF 6-12 30° UNCOATED p.C733

Unit : mm

EDP No.	Mill Diameter	Width of Face	Internal Diameter	No. of Teeth
	D	S	d	
E2679401	40.0	40	● 16	6
E2679501	50.0	50	22	8
E2679600	60.0	30	27	8
E2679601	60.0	60	27	8
E2679750	75.0	35	27	10
E2679751	75.0	75	27	10
E2679900	90.0	35	27	10
E2679902	110.0	35	32	12

- Tolerance of Internal Diameter = +0.018 ~ 0
- ▶ TIN-COATING, TiCN-COATING & TiAIN-COATING is available on your request.

HSS Co8 DIN 1880 NF 6-12 30° UNCOATED p.C733

Unit : mm

EDP No.	Mill Diameter	Width of Face	Internal Diameter	No. of Teeth
	D	S	d	
E2679400	40.0	32	● 16	6
E2679500	50.0	36	22	8
E2679630	63.0	40	27	8
E2679800	80.0	45	27	10
E2679901	100.0	50	32	10
E2679903	125.0	56	40	12
E2679904	160.0	63	50	12

- Tolerance of Internal Diameter = +0.018 ~ 0
- ▶ TIN-COATING, TiCN-COATING & TiAIN-COATING is available on your request.

Mill Dia. Tolerance(mm)	Width of Face Tolerance(mm)	Internal Dia. Tolerance(mm)
+0.25 -0.15	+0.5 -0	+0.02 -0

◎ : Excellent ○ : Good

ISO Material Description	P										M				K					
	Non-alloy steel					Low alloy steel					High alloyed steel, and tool steel		Stainless steel		Grey cast iron	Nodular cast iron		Malleable cast iron		
VDI 3323	1	2	3	4	5	6	7	8	9	10	11	12	13	14	15	16	17	18	19	20
HRc	13	25	28	32	38	10	29	32	38	45	15	35	23	10	10	26	3	25	21	21
HB	125	190	250	270	300	180	275	300	350	200	325	200	240	180	180	260	160	250	130	230
Recommended	◎	◎	◎	◎	◎	◎	◎	◎	◎	◎	◎	◎	◎	◎	◎	◎	◎	◎	◎	◎

ISO Material Description	N										S					H					
	Aluminum-wrought alloy		Aluminum-cast, alloyed			Copper and Copper Alloys (Bronze / Brass)					Non Metallic Materials		Heat Resistant Super Alloys			Titanium Alloys	Hardened steel	Chilled Cast Iron	Hardened Cast Iron		
VDI 3323	21	22	23	24	25	26	27	28	29	30	31	32	33	34	35	36	37	38	39	40	41
HRc	15	30	25	38	34	15	30	25	38	34	200	280	250	350	320	400 Rm	1050 Rm	550	630	400	550
HB	60	100	75	90	130	110	90	100								400 Rm	1050 Rm	550	630	400	550
Recommended	◎	◎	◎	◎	◎	◎	◎	◎	◎	◎	◎	◎	◎	◎	◎	◎	◎	◎	◎	◎	◎



FLAT SHANK **E2498** SERIES

HSSCo8, 4 FLUTE CORNER ROUNDING CUTTERS

- HSSCo8, 4 SCHNEIDEN VIERTELKREISFRÄSER
- Fraise HSSCo8, 1/4 de cercle, 4 dents
- 4 TAGLIENTI PER RAGGIATURA DI SPIGOLI

▶ These tools can be adapted for many screw machine applications as end forming tools to form a specific radius.

▶ Dieses Werkzeug kann an vielen Scrow maschine als Finishingtool für spezielle Radien montiert werden.

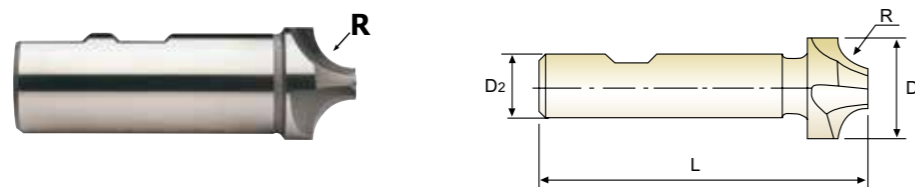

HSS Co8 DIN 6518 N 4 0° DIN 1835B UNCOATED p.C734

Unit : mm

EDP No.	Radius	Outside Diameter	Shank Diameter	Overall Length
	R(H11)	D	D2(h6)	L
E2498010	R1.0	8.0	10	60
E2498015	R1.5	9.0	10	60
E2498020	R2.0	10.0	10	60
E2498025	R2.5	11.0	10	60
E2498030	R3.0	12.0	12	60
E2498035	R3.5	13.0	12	60
E2498040	R4.0	14.0	12	60
E2498045	R4.5	15.0	12	60
E2498050	R5.0	16.0	12	60
E2498055	R5.5	19.0	16	67
E2498060	R6.0	20.0	16	67
E2498065	R6.5	21.0	16	71
E2498070	R7.0	22.0	16	71
E2498075	R7.5	23.0	16	71
E2498080	R8.0	24.0	16	71
E2498085	R8.5	25.0	25	85
E2498090	R9.0	26.0	25	85
E2498095	R9.5	27.0	25	85

▶ TIN-COATING, TICN-COATING & TIAIN-COATING is available on your request.

▶ NEXT PAGE

Tolerances according to DIN 7160 & 7161

	Nominal-Diameter in mm					
	from 1 to 3	over 3 to 6	over 6 to 10	over 10 to 18	over 18 to 30	over 30 to 50
	Tolerance range in μm					
H11	+60 0	+75 0	+90 0	+110 0	+130 0	+160 0
h6	0 -6	0 -8	0 -9	0 -11	0 -13	0 -16

◎ : Excellent ○ : Good

ISO	P										M				K					
	Non-alloy steel					Low alloy steel					High alloyed steel, and tool steel				Stainless steel		Grey cast iron	Nodular cast iron		Malleable cast iron
Material Description	1	2	3	4	5	6	7	8	9	10	11	12	13	14	15	16	17	18	19	20
VDI 3323	1	2	3	4	5	6	7	8	9	10	11	12	13	14	15	16	17	18	19	20
HRc	13	25	28	32	38	42	48	52	58	62	68	72	78	82	88	92	98	102	108	112
HB	125	190	250	270	300	180	275	300	350	200	325	200	240	180	180	260	160	250	130	230
Recommended	◎	◎	◎	◎	◎	◎	◎	◎	◎	◎	◎	◎	◎	◎	◎	◎	◎	◎	◎	◎



FLAT SHANK **E2498** SERIES

HSSCo8, 4 FLUTE CORNER ROUNDING CUTTERS

- HSSCo8, 4 SCHNEIDEN VIERTELKREISFRÄSER
- Fraise HSSCo8, 1/4 de cercle, 4 dents
- 4 TAGLIENTI PER RAGGIATURA DI SPIGOLI

▶ These tools can be adapted for many screw machine applications as end forming tools to form a specific radius.

▶ Dieses Werkzeug kann an vielen Scrow maschine als Finishingtool für spezielle Radien montiert werden.

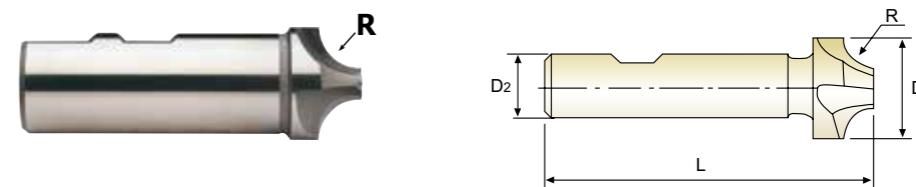

HSS Co8 DIN 6518 N 4 0° DIN 1835B UNCOATED p.C734

Unit : mm

EDP No.	Radius	Outside Diameter	Shank Diameter	Overall Length
	R(H11)	D	D2(h6)	L
E2498100	R10.0	28.0	25	85
E2498105	R10.5	31.0	25	90
E2498110	R11.0	32.0	25	90
E2498120	R12.0	34.0	25	90
E2498125	R12.5	41.0	25	100
E2498130	R13.0	42.0	25	100
E2498140	R14.0	44.0	25	100
E2498150	R15.0	46.0	25	100
E2498160	R16.0	48.0	25	100
E2498180	R18.0	52.0	32	112
E2498200	R20.0	56.0	32	112

▶ TIN-COATING, TICN-COATING & TIAIN-COATING is available on your request.

Tolerances according to DIN 7160 & 7161

	Nominal-Diameter in mm					
	from 1 to 3	over 3 to 6	over 6 to 10	over 10 to 18	over 18 to 30	over 30 to 50
	Tolerance range in μm					
H11	+60 0	+75 0	+90 0	+110 0	+130 0	+160 0
h6	0 -6	0 -8	0 -9	0 -11	0 -13	0 -16

◎ : Excellent ○ : Good

ISO	P										M				K					
	Non-alloy steel					Low alloy steel					High alloyed steel, and tool steel				Stainless steel		Grey cast iron	Nodular cast iron		Malleable cast iron
Material Description	1	2	3	4	5	6	7	8	9	10	11	12	13	14	15	16	17	18	19	20
VDI 3323	1	2	3	4	5	6	7	8	9	10	11	12	13	14	15	16	17	18	19	20
HRc	13	25	28	32	38	42	48	52	58	62	68	72	78	82	88	92	98	102	108	112
HB	125	190	250	270	300	180	275	300	350	200	325	200	240	180	180	260	160	250	130	230
Recommended	◎	◎	◎	◎	◎	◎	◎	◎	◎	◎	◎	◎	◎	◎	◎	◎	◎	◎	◎	◎



RECOMMENDED CUTTING CONDITIONS
EMPFOHLENE SCHNEIDPARAMETER

ML012, ML112, ML022, ML122 SERIES

MULTI FLUTE DOVETAIL CUTTERS TYPE 'A', 'C', 'E'

Vc = m/min.
fz = mm/tooth
RPM = rev./min.
FEED = mm/min.

ISO	VDI 3323	Material Description	Parameter	Diameter (Ø)						
				16.0	20.0	25.0	32.0	40.0	50.0	63.0
P	1	Non-alloy steel	Vc	30	30	30	30	30	30	30
			fz	0.03	0.037	0.026	0.042	0.043	0.03	0.031
			RPM	597	477	382	298	239	191	152
	FEED		107	106	79	125	123	92	75	
	2		Vc	15	15	15	15	15	15	15
			fz	0.031	0.036	0.031	0.041	0.043	0.026	0.031
			RPM	298	239	191	149	119	95	76
	FEED		56	52	47	61	62	40	38	
	3-4		Vc	10	10	10	10	10	10	10
			fz	0.031	0.035	0.028	0.04	0.042	0.03	0.033
			RPM	199	159	127	99	80	64	51
FEED	37	33	29	40	40	31	27			
5	Vc	10	10	10	10	10	10	10		
	fz	0.021	0.02	0.02	0.02	0.022	0.02	0.023		
	RPM	199	159	127	99	80	64	51		
FEED	25	19	20	20	21	20	19			
6	Vc	15	15	15	15	15	15	15		
	fz	0.031	0.036	0.031	0.041	0.043	0.026	0.031		
	RPM	298	239	191	149	119	95	76		
FEED	56	52	47	61	62	40	38			
7	Vc	10	10	10	10	10	10	10		
	fz	0.031	0.035	0.028	0.04	0.042	0.03	0.033		
	RPM	199	159	127	99	80	64	51		
FEED	37	33	29	40	40	31	27			
8-9	Vc	10	10	10	10	10	10	10		
	fz	0.021	0.02	0.02	0.02	0.022	0.02	0.023		
	RPM	199	159	127	99	80	64	51		
FEED	25	19	20	20	21	20	19			
10	Vc	15	15	15	15	15	15	15		
	fz	0.031	0.036	0.031	0.041	0.043	0.026	0.031		
	RPM	298	239	191	149	119	95	76		
FEED	56	52	47	61	62	40	38			
11.1	Vc	10	10	10	10	10	10	10		
	fz	0.021	0.02	0.02	0.02	0.022	0.02	0.023		
	RPM	199	159	127	99	80	64	51		
FEED	25	19	20	20	21	20	19			
N	21~25	Aluminum-wrought alloy, Aluminum-cast, alloyed	Vc	95	85	90	90	95	90	
			fz	0.03	0.04	0.029	0.041	0.042	0.03	0.033
			RPM	1890	1353	1146	895	756	541	455
			FEED	340	325	266	367	381	260	240



RECOMMENDED CUTTING CONDITIONS
EMPFOHLENE SCHNEIDPARAMETER

ML032, ML132, ML042, ML142 SERIES

MULTI FLUTE DOVETAIL CUTTERS TYPE 'B', 'D', 'F'

Vc = m/min.
fz = mm/tooth
RPM = rev./min.
FEED = mm/min.

ISO	VDI 3323	Material Description	Parameter	Diameter (Ø)			
				16.0	20.0	25.0	32.0
P	1	Non-alloy steel	Vc	30	30	30	30
			fz	0.03	0.037	0.026	0.042
			RPM	597	477	382	298
	FEED		107	106	79	125	
	2		Vc	15	15	15	15
			fz	0.031	0.036	0.031	0.041
			RPM	298	239	191	149
	FEED		56	52	47	61	
	3-4		Vc	10	10	10	10
			fz	0.031	0.035	0.028	0.04
			RPM	199	159	127	99
FEED	37	33	29	40			
5	Vc	10	10	10	10		
	fz	0.021	0.02	0.02	0.02		
	RPM	199	159	127	99		
FEED	25	19	20	20			
6	Vc	15	15	15	15		
	fz	0.031	0.036	0.031	0.041		
	RPM	298	239	191	149		
FEED	56	52	47	61			
7	Vc	10	10	10	10		
	fz	0.031	0.035	0.028	0.04		
	RPM	199	159	127	99		
FEED	37	33	29	40			
8-9	Vc	10	10	10	10		
	fz	0.021	0.02	0.02	0.02		
	RPM	199	159	127	99		
FEED	25	19	20	20			
10	Vc	15	15	15	15		
	fz	0.031	0.036	0.031	0.041		
	RPM	298	239	191	149		
FEED	56	52	47	61			
11.1	Vc	10	10	10	10		
	fz	0.021	0.02	0.02	0.02		
	RPM	199	159	127	99		
FEED	25	19	20	20			
N	21~25	Aluminum-wrought alloy, Aluminum-cast, alloyed	Vc	95	85	90	90
			fz	0.03	0.04	0.029	0.041
			RPM	1890	1353	1146	895
			FEED	340	325	266	367



RECOMMENDED CUTTING CONDITIONS
EMPFOHLENE SCHNEIDPARAMETER

ML092 SERIES

MULTI FLUTES SIDE AND FACE MILLING CUTTERS WITH STRAIGHT TEETH

Vc = m/min.
fz = mm/tooth
RPM = rev./min.
FEED = mm/min.

ISO	VDI 3323	Material Description	Parameter	Diameter (Ø)				
				50.0	63.0	80.0	100.0	125.0
P	1	Non-alloy steel	Vc	25	25	25	25	25
			fz	0.045	0.058	0.06	0.063	0.066
			RPM	159	126	99	80	64
			FEED	129	161	143	130	126
	2	Non-alloy steel	Vc	20	20	20	20	20
			fz	0.04	0.036	0.041	0.038	0.05
			RPM	127	101	80	64	51
	3-4	Non-alloy steel	Vc	15	15	15	15	15
			fz	0.034	0.031	0.033	0.034	0.042
			RPM	95	76	60	48	38
5	Non-alloy steel	Vc	10	10	10	10	10	
		fz	0.031	0.029	0.03	0.03	0.036	
		RPM	64	51	40	32	25	
6	Low alloy steel	Vc	20	20	20	20	20	
		fz	0.04	0.036	0.041	0.038	0.05	
		RPM	127	101	80	64	51	
7	Low alloy steel	Vc	15	15	15	15	15	
		fz	0.034	0.031	0.033	0.034	0.042	
		RPM	95	76	60	48	38	
8-9	Low alloy steel	Vc	10	10	10	10	10	
		fz	0.031	0.029	0.03	0.03	0.036	
		RPM	64	51	40	32	25	
10	High alloyed steel, and tool steel	Vc	20	20	20	20	20	
		fz	0.04	0.036	0.041	0.038	0.05	
		RPM	127	101	80	64	51	
11.1	High alloyed steel, and tool steel	Vc	10	10	10	10	10	
		fz	0.031	0.029	0.03	0.03	0.036	
		RPM	64	51	40	32	25	
N	21~25	Aluminum-wrought alloy, Aluminum-cast, alloyed	Vc	100	100	100	100	100
			fz	0.018	0.023	0.026	0.024	0.033
			RPM	637	505	398	318	255
			FEED	206	256	248	199	252

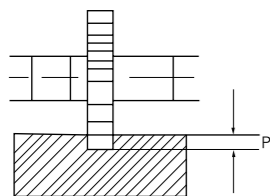

MILLING DEPTH P = WIDTH OF FACES



RECOMMENDED CUTTING CONDITIONS
EMPFOHLENE SCHNEIDPARAMETER

ML102 SERIES

MULTI FLUTE SIDE AND FACE MILLING CUTTERS WITH STAGGERED TEETH

Vc = m/min.
fz = mm/tooth
RPM = rev./min.
FEED = mm/min.

ISO	VDI 3323	Material Description	Parameter	Diameter (Ø)						
				50.0	63.0	80.0	100.0	125.0	160.0	200.0
P	1	Non-alloy steel	Vc	25	25	25	25	25	25	25
			fz	0.058	0.08	0.081	0.081	0.072	0.081	0.079
			RPM	159	126	99	80	64	50	40
			FEED	129	162	145	129	101	105	94
	2	Non-alloy steel	Vc	20	20	20	20	20	20	
			fz	0.053	0.052	0.055	0.05	0.055	0.05	0.048
			RPM	127	101	80	64	51	40	32
	3-4	Non-alloy steel	Vc	15	15	15	15	15	15	
			fz	0.044	0.043	0.044	0.044	0.045	0.044	0.041
			RPM	95	76	60	48	38	30	24
5	Non-alloy steel	Vc	10	10	10	10	10	10		
		fz	0.039	0.04	0.04	0.039	0.039	0.04	0.039	
		RPM	64	51	40	32	25	20	16	
6	Low alloy steel	Vc	20	20	20	20	20	20		
		fz	0.053	0.052	0.055	0.05	0.055	0.05	0.048	
		RPM	127	101	80	64	51	40	32	
7	Low alloy steel	Vc	15	15	15	15	15	15		
		fz	0.044	0.043	0.044	0.044	0.045	0.044	0.041	
		RPM	95	76	60	48	38	30	24	
8-9	Low alloy steel	Vc	10	10	10	10	10	10		
		fz	0.039	0.04	0.04	0.039	0.039	0.04	0.039	
		RPM	64	51	40	32	25	20	16	
10	High alloyed steel, and tool steel	Vc	20	20	20	20	20	20		
		fz	0.053	0.052	0.055	0.05	0.055	0.05	0.048	
		RPM	127	101	80	64	51	40	32	
11.1	High alloyed steel, and tool steel	Vc	10	10	10	10	10	10		
		fz	0.039	0.04	0.04	0.039	0.039	0.04	0.039	
		RPM	64	51	40	32	25	20	16	
N	21~25	Aluminum-wrought alloy, Aluminum-cast, alloyed	Vc	100	100	100	100	100	100	
			fz	0.023	0.031	0.035	0.031	0.036	0.029	0.031
			RPM	637	505	398	318	255	199	159
			FEED	205	251	251	197	202	150	148

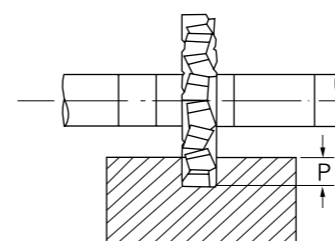

MILLING DEPTH P = WIDTH OF FACES



RECOMMENDED CUTTING CONDITIONS
EMPFOHLENE SCHNEIDPARAMETER

E2675 SERIES MULTI FLUTE SHELL END MILL

Vc = m/min.
fz = mm/tooth
RPM = rev./min.
FEED = mm/min.

Table with columns: ISO, VDI 3323, Material Description, Ae, Ap, Parameter, Diameter (Ø) [40.0, 50.0, 63.0, 80.0, 100.0, 125.0, 160.0]. Rows include Non-alloy steel and Low alloy steel.

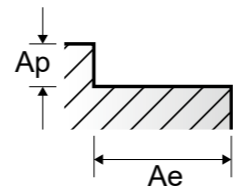

E2676 SERIES MULTI FLUTE SHELL END MILL for ALUMINUM

Table with columns: ISO, VDI 3323, Material Description, Ae, Ap, Parameter, Diameter (Ø) [30.0, 40.0, 50.0, 60.0, 63.0, 75.0, 80.0, 100.0]. Row includes Aluminum-wrought alloy, Aluminum-cast, alloyed.

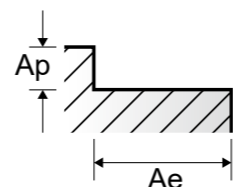

RECOMMENDED CUTTING CONDITIONS
EMPFOHLENE SCHNEIDPARAMETER

E2677, E2678 SERIES MULTI FLUTE ROUGHING SHELL END MILL

Vc = m/min.
fz = mm/tooth
RPM = rev./min.
FEED = mm/min.

Table with columns: ISO, VDI 3323, Material Description, Ae, Ap, Parameter, Diameter (Ø) [40.0, 50.0, 63.0, 80.0, 100.0, 125.0, 160.0]. Rows include Non-alloy steel, Low alloy steel, and High alloyed steel, and tool steel.

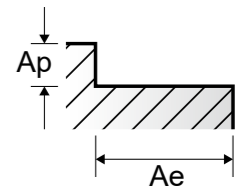

E2679 SERIES MULTI FLUTE ROUGHING & FINISHING SHELL END MILL

Table with columns: ISO, VDI 3323, Material Description, Ae, Ap, Parameter, Diameter (Ø) [40.0, 50.0, 63.0, 80.0, 100.0, 125.0, 160.0]. Rows include Non-alloy steel, Low alloy steel, and High alloyed steel, and tool steel.



RECOMMENDED CUTTING CONDITIONS
EMPFOHLENE SCHNEIDPARAMETER

E2498 SERIES

4 FLUTE CORNER ROUNDING CUTTERS

Vc = m/min.
fz = mm/tooth
RPM = rev./min.
FEED = mm/min.

ISO	VDI 3323	Material Description	Parameter	Diameter (Ø)											
				8.0	9.0	10.0	11.0	12.0	14.0	16.0	20.0	24.0	28.0	34.0	48.0
P	1	Non-alloy steel	Vc	20	20	20	20	20	20	20	20	20	20	20	20
			fz	0.017	0.022	0.02	0.021	0.021	0.025	0.029	0.032	0.038	0.042	0.049	0.058
			RPM	796	707	637	579	531	455	398	318	265	227	187	133
	FEED		54	62	51	49	45	45	46	41	40	38	37	31	
	2		Vc	15	15	15	15	15	15	15	15	15	15	15	15
			fz	0.015	0.016	0.016	0.019	0.019	0.023	0.029	0.033	0.039	0.04	0.048	0.053
			RPM	597	531	477	434	398	341	298	239	199	171	140	99
	FEED		36	34	31	33	30	31	35	32	31	27	27	21	
	3-4		Vc	10	10	10	10	10	10	10	10	10	10	10	10
			fz	0.018	0.023	0.02	0.024	0.024	0.023	0.03	0.034	0.04	0.05	0.048	0.05
			RPM	398	354	318	289	265	227	199	159	133	114	94	66
	FEED		29	33	25	28	25	21	24	22	21	23	18	13	
6	Vc	15	15	15	15	15	15	15	15	15	15	15	15		
	fz	0.015	0.016	0.016	0.019	0.019	0.023	0.029	0.033	0.039	0.04	0.048	0.053		
	RPM	597	531	477	434	398	341	298	239	199	171	140	99		
FEED	36	34	31	33	30	31	35	32	31	27	27	21			
7-8	Vc	10	10	10	10	10	10	10	10	10	10	10	10		
	fz	0.018	0.023	0.02	0.024	0.024	0.023	0.03	0.034	0.04	0.05	0.048	0.05		
	RPM	398	354	318	289	265	227	199	159	133	114	94	66		
FEED	29	33	25	28	25	21	24	22	21	23	18	13			
10	Vc	15	15	15	15	15	15	15	15	15	15	15	15		
	fz	0.015	0.016	0.016	0.019	0.019	0.023	0.029	0.033	0.039	0.04	0.048	0.053		
	RPM	597	531	477	434	398	341	298	239	199	171	140	99		
FEED	36	34	31	33	30	31	35	32	31	27	27	21			
11.1	Vc	10	10	10	10	10	10	10	10	10	10	10	10		
	fz	0.018	0.023	0.02	0.024	0.024	0.023	0.03	0.034	0.04	0.05	0.048	0.05		
	RPM	398	354	318	289	265	227	199	159	133	114	94	66		
FEED	29	33	25	28	25	21	24	22	21	23	18	13			
N	21~25	Aluminum-wrought alloy, Aluminum-cast, alloyed	Vc	90	80	90	85	90	90	80	90	90	85	85	90
			fz	0.018	0.021	0.02	0.023	0.022	0.025	0.031	0.034	0.038	0.045	0.05	0.058
			RPM	3581	2829	2865	2460	2387	2046	1592	1432	1194	966	796	597
			FEED	258	238	229	226	210	205	197	195	181	174	159	138



Leading Through Innovation



TECHNICAL DATA

TECHNISCHE DATEN

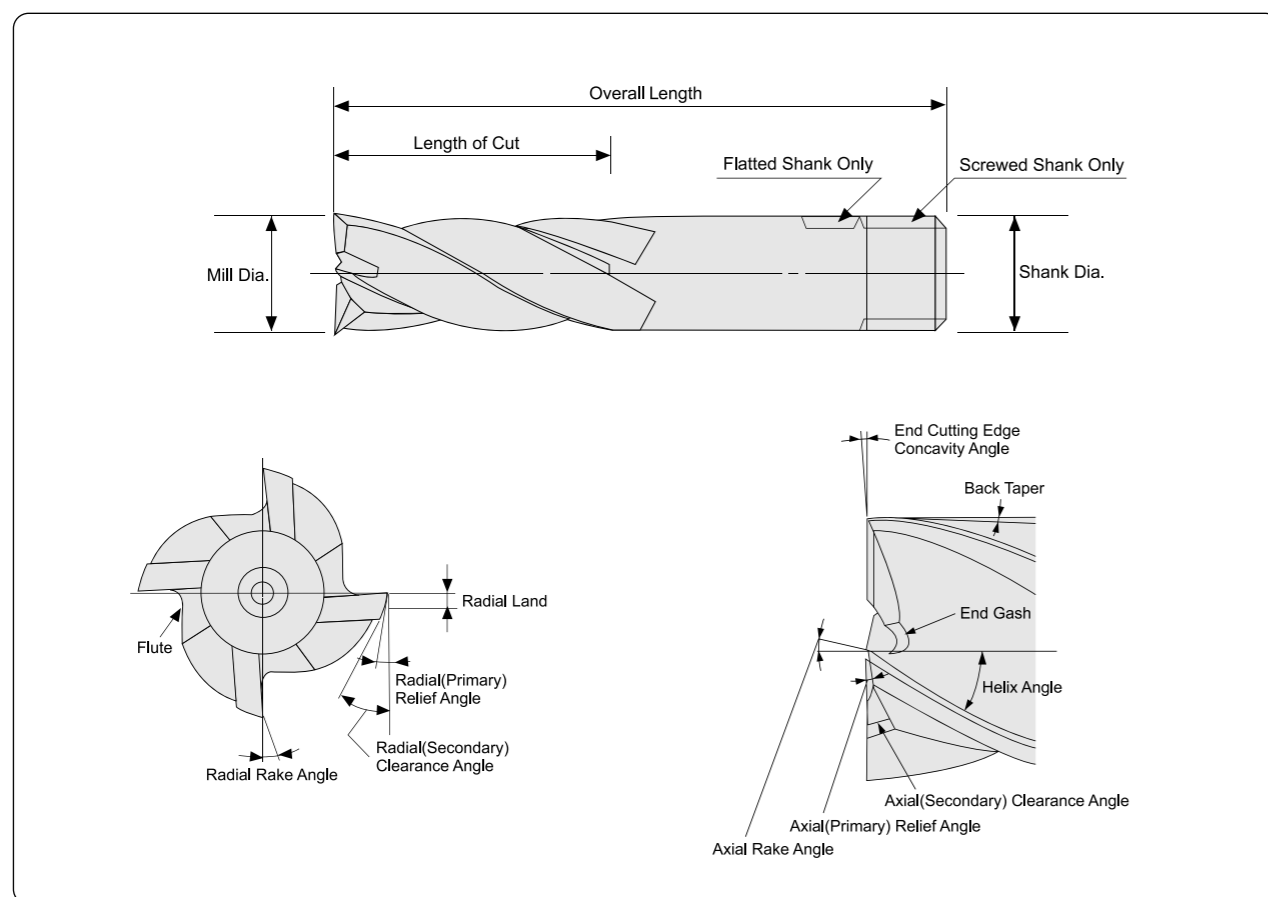
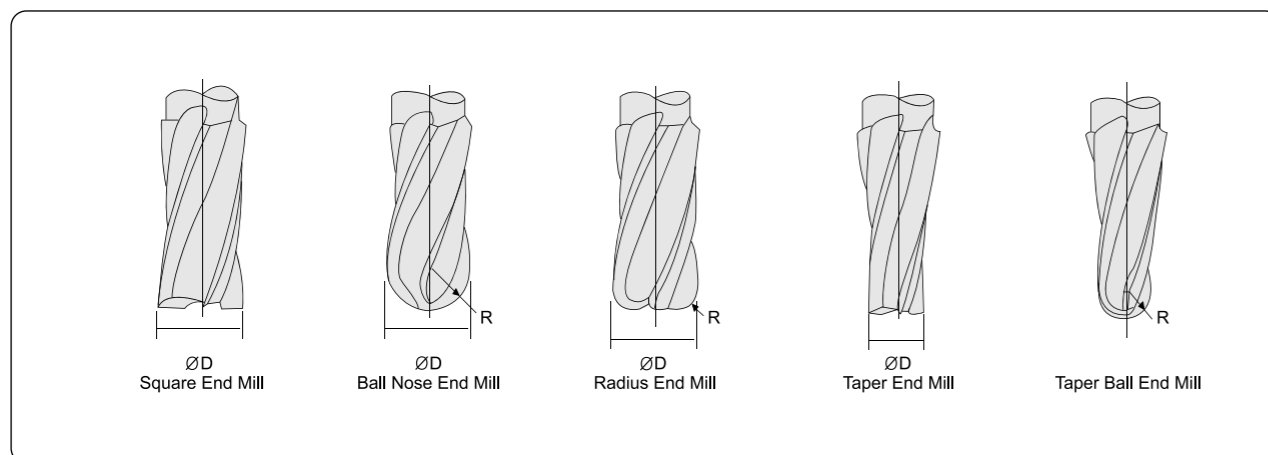
**1** NAMES OF END MILL PARTS
ERLÄUTERUNG DER FRÄSERTEILE**2** TYPES OF END MILL
FRÄSERTYPEN

Speed, feed and depth of cut are the most important factors to consider for best results in milling. Improper feeds and speeds often cause low production, poor work quality and unnecessary damage to the cutter. This section covers the basic principles of speed and feed selection for milling cutters and end mills. It will serve as a guide in setting-up new milling jobs.

Geschwindigkeit, Vorschub und Schnitttiefe sind die wichtigsten Faktoren, um das beste Fräsergebnis zu erzielen. Ungeeignete Vorschübe und Geschwindigkeiten verursachen oft niedrige Produktivität, schlechte Bearbeitungsqualität und unnötige Beschädigung des Fräasers. Dieser Abschnitt beinhaltet die Basisprinzipien von Geschwindigkeit- und Vorschubauswahl für Fräser und Scheibenfräser. Dieser Abschnitt sollte als ein Setting-up-Führer neuer Fräsaufgaben dienen.

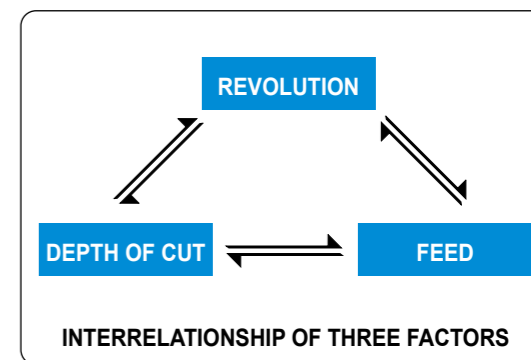
**3** SPEEDS
GESCHWINDIGKEIT

In milling, SPEED is measured in peripheral feet per minute.(revolution per minute times cutter circumference in feet) This is frequently referred to as "peripheral speed" "cutting speed" or "surface speed".

Beim Fräsen, Geschwindigkeit ist gemessen in Bogenlänge pro Minute. Dies wird oft als 'peripheral speed', 'cutting speed' oder 'surface speed' bezeichnet.

Revolutions per Minute
Umdrehung pro Minute

$$N = \frac{1000V}{\pi D}$$

V : Cutting Speed(m/min) / Schneidgeschwindigkeit

D : Diameter of Tool(mm) / Werkzeugdurchmesser

N : Revolution per minute(rev/min) / Umdrehung pro Minute

π : 3.1416

They will have to be tempered to suit the conditions ON THE JOB. For example:

Dies muß der jeweiligen Aufgabe angepaßt werden. Zum Beispiel:

Use Lower Speed Ranges for
Niedrig Geschwindigkeitsbereiche für

Hard materials / Hartes Material
Tough materials / Rauhes Material
Abrasive materials / Abrasives Material
Heavy cuts / Heavy cut
Minimum tool wear / Minimale Werkzeugabnutzung
Maximum cutter life / Maximale Standzeit

Use Higher Speed Ranges for
Hohe Geschwindigkeitsbereiche für

Softer materials / Weiches Material
Better finishes / Bessere Oberflächengüte
Smaller diameter cutters / Kleinere Fräserdurchmesser
Light cuts / Light cut
Frail work pieces or set-ups / Zerbrechliche Stücke oder Set-up
Hand feed operations / Handarbeit
Maximum production rates / Maximale Produktivität
Non-metallics / Nichtmetallische Werkstoffe

4 FEEDS
VORSCHUB

Feed is usually measured in millimeters per minute. It is the product of feed per tooth times revolution per minute times the number of teeth in the cutter. Due to variations in cutter sizes, numbers of teeth and revolutions per minute, all feed rates should be calculated from feed per tooth. Feed per tooth is the basis of all feed rates per minute, whether the cutters are large or small, fine or coarse tooth, and are run at high or low peripheral speed. Because feed per tooth affects chip thickness. It is a very important factor in cutter life.

Highest possible feed per tooth will usually give longer cutter life between grinds and greater production per grind. Excessive feeds may over load the cutter teeth and cause breakage or chipping of the cutting edges. The following factors should be kept in mind when using the recommended starting feed per tooth.

Vorschub wird meist in Millimeter pro Minute gemessen. Er ist das Produkt von Vorschub pro Zahn, Umdrehung pro Minute oder der Anzahl der Zähne am Werkzeug. Aufgrund der Variationen in Fräsergrößen, Anzahl der Zähne und Umdrehungen pro Minute, Vorschübe sollten mit Vorschub pro Zahn gerechnet werden. Vorschub pro Zahn ist die Basis für alle Vorschubraten pro Minute unabhängig davon, ob die Fräser groß, klein, mit Fein- oder Grobgewinde und mit hoher- oder niedriger Bogengeschwindigkeit arbeiten. Vorschub pro Zahn beeinflusst Spandicke, was für ein Werkzeug ein sehr wichtiger Faktor ist. Höchstmöglicher Vorschub pro Zahn verursacht meist längeres Werkzeugleben zwischen Abnutzung und Produktivität pro Abnutzung. Exzessiver Vorschub dagegen wird den Werkzeugzahn überbelasten und Beschädigungen oder Abbröckelungen von Schneidkanten verursachen. Bei der Nutzung von empfohlenen Vorschüben pro Zahn sollten folgende Faktoren berücksichtigt werden.



Feed in millimeters per Minute / Vorschub in Millimeter pro Minute

$$F.M = F.R. \times R.P.M$$

F.R. : Feed per Revolutions in millimeters / Vorschub pro Umdrehungen pro Minute

R.P.M. : Revolutions per Minutes / Umdrehungen pro Minute

The following factors should be kept in mind when using the recommended stating feed per tooth.

Die folgenden Faktoren sind beim Einsatz der Vorschübe pro Zahn zu berücksichtigen.

Use Higher Feeds For

Höherer Vorschub für

Heavy, roughing cuts / Heavy cut, Schruppfräsen
 Rigid set-ups / Robustes Werkstück
 Easy-to-machine work materials / Leicht fräsbares Material
 Rugged cutters / Robuster Fräser
 Slab milling cuts / Scheibenfräsen
 Low tensile strength materials / Material von niedriger Zugfestigkeit
 Coarse tooth cutters / Grobgewinde-Fräser
 Abrasive materials / Abrasives Material

Use Lower Feeds For

Niedrigerer Vorschub für

Light, and finishing cuts / Light cut, Finishing cut
 Frail set-ups / Zerbrechliches Material
 Hard to machine work materials / Schwer fräsbares Material
 Frail and small cutters / Dünne, kleine Fräser
 Deep slots / Tiefnuten
 High tensile strength materials / Material von hoher Zugfestigkeit
 Fine tooth cutters / Feingewinde-Fräser

**SPEED AND FEED CALCULATIONS
FOR MILLING CUTTERS AND OTHER ROTATING TOOLS**

TO FIND	HAVING	FORMULA
Surface(or Periphery) Speed in meter per Minute=S.P.M.	Diameter of Tool in millimeters =D Revolutions per Minute =R.P.M.	$V = \frac{D \times 3.1416 \times R.P.M.}{1000}$
Revolutions per Minute=R.P.M.	Surface Speed in meter per Minute =S.P.M Diameter of Tool in millimeters =D	$R.P.M. = \frac{V \times 1000}{D \times 3.1416}$
Feed per Revolution in millimeters-F.R.	Feed in millimeters per Minute =F.M. Revolution per Minute =R.P.M.	$F.R. = \frac{F.M.}{R.P.M.}$
Feed in millimeters per Minute-F.M.	Feed per Revolution in millimeters =F.R. Revolution per Minute =R.P.M.	$F.M. = F.R. \times R.P.M.$
Number of Cutting Teeth per Minute=T.M.	Number of Teeth in Tool =T Revolution per Minute =R.P.M.	$T.M = T \times R.P.M.$
Feed per tooth=F.T.	Number of Teeth in Tool =T Feed per Revolution in millimeters =R.P.M.	$F.T. = \frac{F.R.}{T}$
Feed per Tooth=F.T.	Number of Teeth in Tool =T Feed in millimeters per Minute =F.M. Speed in Revolution per Minute =R.P.M.	$F.T. = \frac{F.M.}{T \times R.P.M.}$

**CASE OF RESHARPENING
NACHSCHLEIFFÄLLE**

When the product finish become worse, the cutting edge must get dulled, chips become smaller and the cutting sound gets louder. In such cases, a end mill must be resharpened. The following are the damages of end mills when the resharpening is required.

Wenn die Schneidkante abstumpft, verschlechtert sich die Bearbeitungsqualität, Span wird kürzer und das Fräsergeräusch wird lauter. In solchen Fällen muß der Fräser nachgeschliffen werden. Folgend sind Beschädigungen an Fräser, die das Nachschleifen nötig machen.

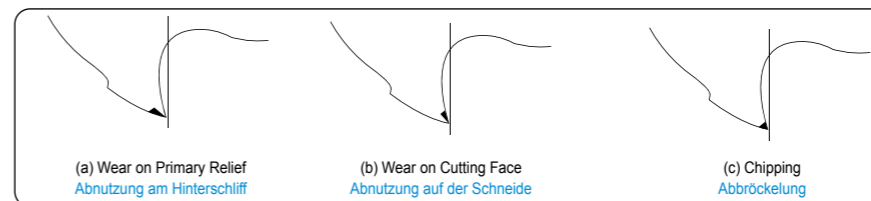

Fig. 1. Damages of Cutting Edge

**SHARPEN AT PREDETERMINED WEAR LAND
SCHLEIFEN BEI VORBESTIMMTEN ABNUTZUNGSFLÄCHEN**

Cutters should be sharpened as soon as the wear land (Fig. 2.) reaches a predetermined width. This width should permit sharpening without excessive loss of tool life. It may vary from a few hundredths to some tenth of a millimeter, depending on the type of cutter and the finish required on the product. This method is used on production runs where uneven amounts of stock is removed or where the material varies in machinability. It is also used on small quantity product lots.

Fräser sollten nachgeschliffen werden, so bald die Abnutzungsfläche die vorbestimmte Breite erreicht. Diese Breite sollte ein Schleifen ohne exzessive Verlust der Werkzeuglebensdauer ermöglichen. Sie variiert, in Abhängigkeit von Werkzeugtypen und benötigtem Finish, von Hunderstel bis einigen Zehntel Millimeter. Diese Methode wird in Prozessen angewandt, in denen variierende Mengen von Werkstoffen abgefräst oder Materialien verschiedener Fräsbarkeiten bearbeitet werden. Ebenso in Produktionen kleiner Losgrößen.

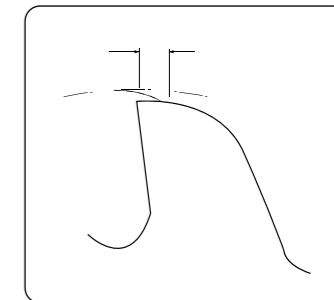

Fig. 2. Wear Land

**RESHARPENING PERIPHERAL CUTTING EDGE
NACHSCHLEIFEN VON PERIPHER-SCHNEIDKANTEN**
1 RESHARPENING PERIPHERAL CUTTING EDGE

Nachschleifen von Primärschneide

The geometry of relief angle in an end mill consist of three methods as shown in Fig.3 concave, flat, and eccentric. Recently, most end mills have the eccentric relief (eccentric sharpening). In this method, since the relief is formed an eccentric are surface in cylindrical grinding method, the roughness of the finished surface of the relief improves and the strength of cutting edge increase at the same time.(Fig.4) As a result, the tool life is improved.

Die Geometrie von Hinterschliffwinkel in einem Fräser hat, wie in Fig. 3 gezeigt, 3 verschiedene Variationen : Konkav, Flach und Exzentrisch. In letzter Zeit, die meisten Fräser haben die exzentrische Form. In dieser Methode verbessern sich Oberflächengüte der bearbeiteten Fläche und die Stärke der Schneidkanten gleichzeitig, was eine Verlängerung der Werkzeuglebensdauer zur Folge hat.

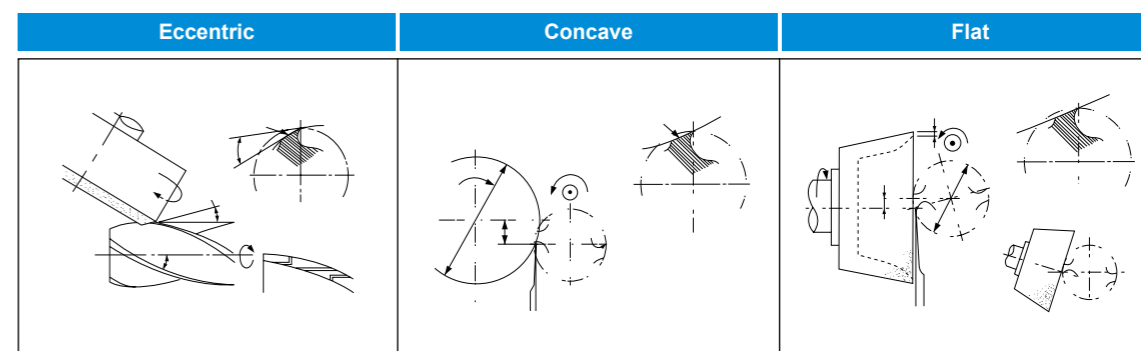

Fig. 3. Three Types of Primary Relief

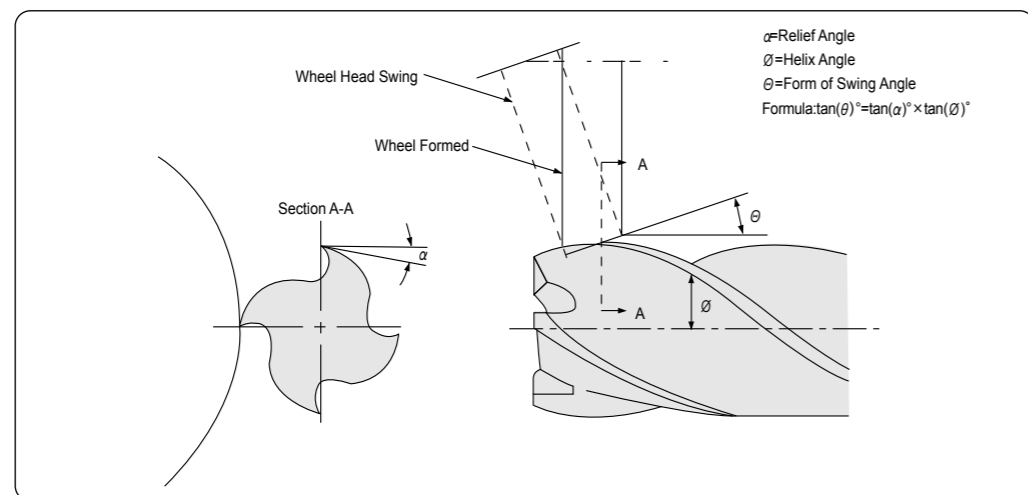

Fig. 4. Tothing of Eccentric Relief Angle

2 ANGLE OF WHEEL INCLINATION
Winkel der Radneigung.

Eccentric relief is produced with a plain wheel positioned with its axis parallel or at a slight angle with the cutter axis. The degree of relief is varied by changing the angle of wheel inclination.

Exzentrischer Hinterschliff wird mit einer, mit der eigenen Achse zur Fräsachse parallelen oder nur geringfügig geneigten Schleifscheibe produziert. Das Grad des Hinterschliffs variiert mit dem Einstellwinkel der Schleifscheiben Einstellung.

Table 1. RECOMMENDED RELIEF ON END MILLS

Mill Diameter (mm)	Eccentric relief indicator drop for relief Angles shown		Checking Distance	Wheel Angles(Deg.) θ			Radial Relief Angles(α 1)	Clearance Angles(α 2)
	Min.	Max.		15° Helix	30° Helix	60° Helix		
-			-	*Angle	*Angle	*Angle	*Angle	*Angle
3.0	0.100	0.130	0.40	4° 24'	9° 25'	26° 28'	16° 02'	25°
6.0	0.090	0.125	0.50	3° 18'	7° 05'	20° 25'	12° 08'	25°
12.0	0.100	0.135	0.65	2° 46'	5° 46'	17° 23'	10° 15'	25°
25.0	0.095	0.140	0.80	2° 15'	4° 15'	14° 16'	8° 21'	25°
40.0	0.085	0.125	0.80	2° 01'	4° 33'	12° 48'	7° 29'	25°
50.0	0.085	0.125	0.80	2° 01'	4° 33'	12° 48'	7° 29'	25°

The actual at the radial relief angle is normally kept within the range shown but may be varied to suit the cutter material, the work material and the operating conditions.

Die Freiwinkel sind normalerweise in den angegebenen Maßen, sie schwanken je nach Werkzeug, Werkstück und den Einsatzbedingungen

* Angle is calculated from the basic mean at the radical angle.

Der Winkel wird von der Hauptschneide zum Radialwinkel gemessen.

8 RESHARPENING END TEETH
NACHSCHLEIFEN DES ENDTZAHNS

The three necessary operations and one option feature, along with setup suggestions are shown in Fig.5 A to D in each drawing, the shaded area indicates the surface being ground.

Die drei nötigen Operationen und eine Option werden, zusammen mit einem Rüstvorschlagn, in Bild 5 A bis D gezeigt. Die dunklen Flächen zeigen Bereiche an, die nachgeschliffen werden.

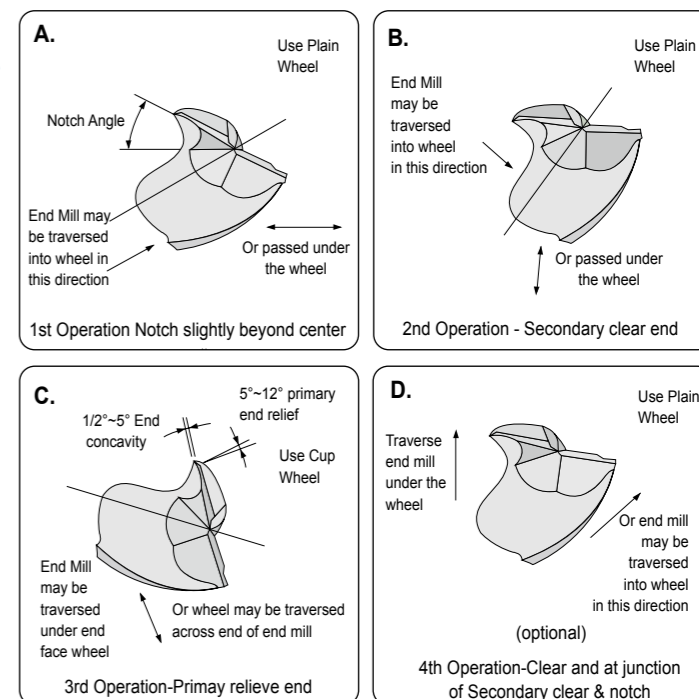

Fig 5. PROCEDURE FOR SHARPENING END OF 2 FLUTE SQUARE END MILLS

9 INSPECTION
INSPEKTION

The inspection is calculated by using the formula shown in Table1.
Procedure To Check Radial Relief Angles With Indicators.

Die Inspektion wird aufgrund der Formel aus der Tabelle 1 durchgeführt.
Prozedur, um mit Indikator radialen Hinterschliffwinkel zu messen.

1. Mount the cutter to rotate freely with no end movement.
2. Adjust the sharp pointed indicator to bear at the very tip of the cutting edge, pointing in a radial line, shown in Fig.6
3. Roll the cutter the tabulated amount gives under "checking distance" using the second indicator as control.
4. Consult chart for amount of drop for the particular diameter and relief angle.

1. Fräser so montieren, daß er frei rotiert ohne sich seitlich zu bewegen.
2. Indikator so justieren, daß der Stab, in radiale Richtung zeigend, am äußersten Rand der Schneidkante angelegt ist (Bild 6).
3. Den Fräser um tabellierte 'Checking distance' rollen. Einen zweiten Indikator zur Kontrolle einsetzen.
4. Um den 'Drop' für den gemessenen Durchmesser und Hinterschliffwinkel zu erhalten, Chart konsultieren.

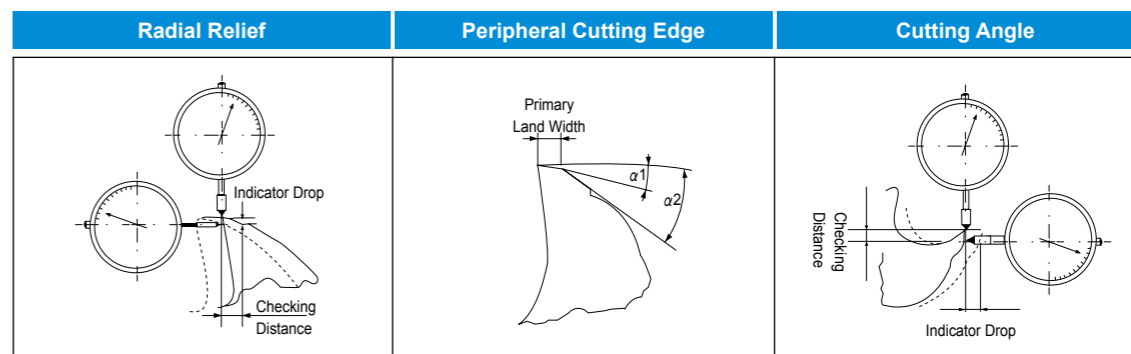

Fig. 6. Indicator Set-Up for Checking

**10** TROUBLE SHOOTING IN MILLING
PROBLEMLÖSUNG BEI FRÄSEN

Trouble Problem	Occurrences of trouble Aufreten des Problems	Countermeasures Gegenmaßnahmen
Breaking of tool Werkzeugbruch	<ul style="list-style-type: none"> At time of engaging with work material Beim Eintritt in das Werkstück When ending cut Beim Austritt aus dem Werkstück 	<ol style="list-style-type: none"> Decrease feed rate. / Vermindern von Vorschub Decrease projection amount / Schnitttiefe verringern Shorten cutting edge length to required minimum limit Eingriffslänge reduzieren
	<ul style="list-style-type: none"> During normal cutting Während des Fräsens 	<ol style="list-style-type: none"> Decrease feed rate / Vorschub mindern Control wear → replace tool early Abnutzung kontrollieren - Werkzeug frühzeitig ersetzen Replace chuck or collet / Chuck oder Collet ersetzen Decrease projection amount / Schnitttiefe verringern Carry out honing / Nachschleifen If 4 flute, reduce to 2 flute(clogging of chipping) Wenn 4 Schneiden, zu 2 Schneiden verkleinern If dry cutting change to wet cutting utilize cutting fluid. In case of wet cutting flow oil supplied from the front, change to from rear angle of side top. Use ample with rate. Wenn Trockenfräsen, zu Naßfräsen wechseln. Wenn Naßfräsen mit Kühlfüssigkeitsversorgung von Vorne, zu einer Ölversorgung aus hinterem oder seitlich-oberem Winkel ändern. Ölversorgung reichlich gestalten
	<ul style="list-style-type: none"> When changing direction of feed Wenn Vorschubrichtung geändert wird 	<ol style="list-style-type: none"> Utilize circular interpolation(in case of NC machine) or temporarily stop feed(Dowelling) Circular interpolation benutzen(bei NC-Maschinen) oder Vorschub vorübergehend stoppen. Reduce feed rate before and after change of directions Vor und nach dem Richtungswechsel den Vorschub mindern Replace chuck or collect / Chuck oder Collet ersetzen,
Fracture of cutting edge Beschädigung der Schneidkante	<ul style="list-style-type: none"> Fracture of corners Eckenbruch 	<ol style="list-style-type: none"> Carry out chamfering or nose with hand lapper. Mit Handlapper eine Abschrägung durchführen. Down cut → Up cut / Down cut → Up cut
	<ul style="list-style-type: none"> Fracture at boundary of depth of cut Beschädigung an der Schneidtiefgrenze 	<ol style="list-style-type: none"> Down cut → Up cut / Down cut → Up cut Reduce cutting speed / Schneidgeschwindigkeit mindern
	<ul style="list-style-type: none"> Chipping at center part or overall Abbröckelung an der Hauptschneide oder überall 	<ol style="list-style-type: none"> Carry out honing. Or enlarge. / Nachschleifen oder erweitern Change number of rotation(in case machine vibrates) Drehzahl ändern(wenn Maschine vibriert). Increase cutting speed / Fräsgeschwindigkeit erhöhen. In ease of squeaking noise during cutting, increase feed. Wenn quitschendes Fräsgeräusch zu vernehmen, Vorschub erhöhen. If dry cutting use cutting fluid or blow air. Wenn Trockenfräsen, Kühlfüssigkeit oder Luft zuführen Replace chuck or collet / Chuck oder Collet austauschen. Reduce cutting speed / Fräsgeschwindigkeit reduzieren.
	<ul style="list-style-type: none"> Large fracturing of cutting edge Größere Beschädigung an Schneidkanten 	<ol style="list-style-type: none"> Decrease feed rate / Vorschub mindern. If 4 flute reduce to 2 flute Wenn 4 Schneiden, zu 2 Schneiden wechseln. Carry out honing. Or enlarge / Nachschleifen oder erweitern. Replace chuck or collet / Chuck oder Collet austauschen. Reduce cutting speed / Fräsgeschwindigkeit mindern. If dry cutting, change to wet cutting. In case oil supply in wet cutting is from the front, change to rear at an angle or from side top. Use ample supply. Wenn Trockenfräsen, zu Naßfräsen wechseln. Wenn Naßfräsen mit Kühlfüssigkeitsversorgung von Vorne, zu einer Ölversorgung aus hinterem oder seitlich-oberem Winkel ändern. Ölversorgung reichlich gestalten.



Trouble Problem	Occurrences of trouble Aufreten des Problems	Countermeasures Gegenmaßnahmen
Rapid tool wear Zu schnelle Werkzeugabnutzung		<ol style="list-style-type: none"> Reduce cutting speed / Fräsgeschwindigkeit mindern Up cut → Down cut / Up cut - Down cut Increase feed / Vorschub erhöhen Utilize wet cutting or air / Naßfräsen oder Kühlluft zuführen. If reground tool, improve surface roughness of flank. Beim Nachschleifen, die Oberflächenrauheit der Hauptfreiflächen verbessern.
Inferior finished surface Ungenügende Bearbeitungsoberfläche	<ul style="list-style-type: none"> Surface is good but rough Oberfläche ist gut aber rauh 	<ol style="list-style-type: none"> Decrease feed / Vorschub mindern In case using 2 flute, increase to 4 flute Wenn 2 Schneiden, zu 4 Schneiden wechseln
	<ul style="list-style-type: none"> Small chip welding Kleine Partikelverschweißung 	<ol style="list-style-type: none"> Increase cutting speed / Fräsgeschwindigkeit erhöhen Utilize wet cutting air blow(ample supply) Naßfräsen und Luftzufuhr (reichlich) Carry out fine honing / Feinschliff durchführen Up cut → Down cut / Up cut → Down cut Increase feed or enlarge finish allowance Vorschub erhöhen oder Bearbeitungstoleranz erhöhen
	<ul style="list-style-type: none"> With transverse streaks Mit Querstreifen 	<ol style="list-style-type: none"> Carry out fine honing / Feinschliff durchführen Use water insoluble cutting fluid Wasserunlösliche Kühlfüssigkeit benutzen. Down cut → Up cut / Down cut → Up cut
	<ul style="list-style-type: none"> Signs of excessive cutting Zeichen exzessiven Fräsens 	<ol style="list-style-type: none"> Reduce finishing depth of cut / Frästiefe reduzieren. Increase cutting speed / Fräsgeschwindigkeit erhöhen. Reduce feed / Vorschub mindern
Poor machining accuracy Geringe Genauigkeit der Maschine	<ul style="list-style-type: none"> Finish dimensions are on minus side Bearbeitungsmaße auf der Minusseite 	<ol style="list-style-type: none"> Up cut → Down cut / Up cut → Down cut Reduce finishing depth of cut / Schlichttiefe verringern reduzieren. Replace chuck or collet / Chuck oder Collet austauschen. Reduce projection amount / Projektionsgröße reduzieren. Increase cutting speed / Fräsgeschwindigkeit reduzieren.
	<ul style="list-style-type: none"> Poor perpendicularity Ungenauer Winkel 	<ol style="list-style-type: none"> Reduce finishing depth of cut / Finishing-tiefe reduzieren. Replace chuck or collet / Chuck oder Collet austauschen. Reduce projection amount / Projektionsgröße mindern Increase cutting speed / Fräsgeschwindigkeit erhöhen. 2Flute → 4 Flute / 2 Schneiden → 4 Schneiden Reduce feed / Vorschub mindern. Check wear rate → Replace tool Verschleiß überprüfen → Werkzeug austauschen.
Chattering Rattern		<ol style="list-style-type: none"> Increase feed rate(in case over 0.05 mm/Zahn, try reducing) Vorschub erhöhen(wenn über 0.05mm/Tooth Vorschub reduzieren). Change cutting speed / Fräsgeschwindigkeit ändern. Replace chuck or collet / Chuck oder Collet austauschen. Reduce projection amount / Projektionsgröße reduzieren. Use 2 flute cutter for rough cutting and 4 flute for finishing 2 Schneiden Fräser zum Schrappen und 4 für Finishing einsetzen. Down cut → Up cut / Down cut → Up cut



**11 COMPARISON CHART SCALE FOR HARDNESS
VERGLEICHSTABELLE FÜR HÄRTESKALEN**

Rockwell Hardness C Scale 150kg Brale (HRC)	Diamond Pyramid Hardness Number, Vickers (HV)	Brinell Hardness Standard 10mm Ball 29.42kN (HB)	Rockwell Hardness A Scale 60kg Brale (HRA)	Shore Scleroscope Hardness Number (HS)	Approx. Tensile Strength N/mm ²
68	940	-	85.6	97	-
67	900	-	85.5	95	-
66	865	-	84.5	92	-
65	832	-	83.9	91	-
64	800	-	83.4	88	-
63	772	-	82.8	87	-
62	746	-	82.3	85	-
61	720	-	81.8	83	-
60	697	-	81.2	81	-
59	674	-	80.7	80	-
58	653	-	80.1	78	-
57	633	-	79.6	76	-
56	613	-	79.0	75	-
55	595	-	78.5	74	2079
54	577	-	78.0	72	2010
53	560	-	77.4	71	1952
52	544	500	76.8	69	1883
51	528	487	76.3	68	1824
50	513	475	75.9	67	1755
49	498	464	75.2	66	1687
48	484	451	74.7	64	1639
47	471	442	74.1	63	1578
46	458	432	73.6	62	1530
45	446	421	73.1	60	1481
44	434	409	72.5	58	1432
43	423	400	72.0	57	1383
42	412	390	71.5	56	1334
41	402	381	70.9	55	1294
40	392	371	70.4	54	1245
39	382	362	69.9	52	1216
38	372	353	69.4	51	1177
37	363	344	68.9	50	1157
36	354	336	68.4	49	1118
35	345	327	67.9	48	1079
34	336	319	67.4	47	1059
33	327	311	66.8	46	1030
32	318	301	66.3	44	1000
31	310	294	65.8	43	981
30	302	286	65.3	42	952
29	294	279	64.7	41	932
28	285	271	64.3	41	912
27	279	264	63.8	40	883
26	272	258	63.3	38	863
25	266	253	62.8	38	843
24	260	247	62.4	37	824
23	254	243	62.0	36	804
22	248	237	61.5	35	785
21	243	231	61.0	35	775
20	238	226	60.5	34	755
(18)	230	219	-	33	736
(16)	222	212	-	32	706
(14)	213	203	-	31	677
(12)	204	194	-	29	647
(10)	196	187	-	28	618
(8)	188	179	-	27	598
(6)	180	171	-	26	579
(4)	173	165	-	25	549
(2)	166	158	-	24	530
(0)	160	152	-	24	520

EDP No.	Page	EDP No.	Page	EDP No.	Page
E2464	C653	EH911	C396	G9439	C546
E2492	C644	EH912	C396	G9444	C532
E2498	C724	EH913	C398	G9445	C534
E2509	C654	EH914	C398	G9447	C550
E2510	C651	EH915	C400	G9448	C555
E2516	C658	EH916	C400	G9449	C557
E2535	C643	EH917	C402	G9452	C537
E2553	C660	EH918	C402	G9453	C561
E2554	C662	EH919	C403	G9454	C518
E2570	C646	EH920	C403	G9455	C519
E2571	C649	EH921	C404	G9527	C533
E2572	C655	EH942	C404	G9528	C547
E2573	C656	EHE54	C387	G9540	C556
E2574	C663	EHE55	C387	G9553	C541
E2595	C664	EI450	C483	G9624	C514
E2597	C665	EI451	C482	G9634	C522
E2675	C719	EI880	C481	G9A42	C563
E2676	C720	EI881	C485	G9A68	C531
E2677	C721	EI996	C486	G9A69	C554
E2678	C722	EI997	C478	G9A70	C515
E2679	C723	EIA13	C489	G9B80	C538
E2751	C669	EIA14	C490	G9B81	C520
E2752	C671	EIB04	C492	G9B82	C523
E2753	C666	EIB86	C488	G9B83	C525
E2755	C668	EIB87	C484	G9B84	C526
E2762	C667	EIB88	C491	G9B85	C528
E2SET553	C661	EIB93	C480	G9D67	C257
E5521	C465	EL612	C645	G9D68	C258
E5522	C465	EMB72	C435	G9D69	C259
E5711	C468	EMB73	C435	G9D75	C257
E5742	C468	ESB94	C35	G9D76	C258
E5908	C459	ESD02	C36	G9D77	C259
E5909	C460	G8A01	C119	G9F45	C562
E5910	C458	G8A02	C120	G9F46	C562
E5930	C461	G8A28	C96	G9G44	C530
E5E39	C469	G8A36	C107	G9G45	C535
E5E40	C469	G8A37	C112	G9G46	C543
E5E47	C463	G8A38	C98	G9G47	C545
E5E48	C464	G8A39	C114	G9G48	C549
E5E49	C466	G8A45	C115	G9G49	C551
E5E50	C467	G8A46	C91	G9G50	C553
E5E51	C462	G8A47	C111	G9G51	C558
E5H22	C450	G8A50	C110	G9H73	C559
E5H23	C451	G8A52	C109	G9H74	C559
E5H24	C444	G8A53	C99	G9H75	C560
E5H25	C447	G8A54	C95	G9H76	C560
E9936	C610	G8A59	C100	GA936	C610
E9938	C614	G8A60	C102	GA938	C614
E9940	C608	G8B08	C113	GA940	C608
E9941	C616	G8B54	C90	GA941	C616
E9942	C612	G8B59	C89	GA942	C612
E9A26	C618	G8D62	C101	GAA26	C618
E9A29	C611	G8D63	C121	GAA29	C611
E9A30	C613	G8D64	C122	GAA30	C613
E9A31	C615	G9400	C564	GAA31	C615
E9A32	C609	G9410	C541	GAA32	C609
E9A33	C619	G9424	C529	GAA33	C619
E9A34	C620	G9425	C544	GAA34	C620
E9A35	C617	G9432	C552	GAA35	C617
E9E43	C621	G9433	C548	GAE43	C621
EH831	C401	G9437	C516	GM810	C343
EH841	C401	G9438	C517	GM811	C349

EDP No. INDEX

EDP No.	Page
GM812	C351
GM813	C333
GM814	C353
GM815	C337
GM817	C350
GM818	C338
GM819	C342
GM834	C352
GM839	C341
GM876	C332
GM883	C345
GM886	C334
GM895	C348
GM8A1	C339
GM902	C336
GMF52	C424
GMF53	C424
GMF54	C419
GMF55	C419
GMF56	C425
GMF57	C425
GMF58	C420
GMF59	C420
GMF60	C426
GMF61	C426
GMF62	C421
GMF63	C421
GMG12	C432
GMG13	C432
GMG14	C433
GMG15	C433
GMG16	C428
GMG17	C428
GMG18	C429
GMG19	C429
GMG24	C385
GMG25	C385
GMG26	C386
GMG27	C386
GMG28	C382
GMG29	C382
GMG30	C383
GMG31	C383
GMG40	C380
GMG41	C380
GMG55	C418
GMG56	C418
GMH56	C434
GMH57	C434
GMH58	C431
GMH59	C431
GYF94	C593
GYF95	C592
GYF96	C589
GYF97	C586
GYF98	C594
GYF99	C587
GYG01	C588
GYG02	C591
GYG03	C595
GYG52	C590
GYG72	C587

EDP No.	Page
GYG74	C589
GYG76	C591
GYG77	C586
JAH22	C450
JAH23	C451
JAH24	C444
JAH25	C447
ML012	C706
ML022	C706
ML032	C707
ML042	C707
ML062,	C708
ML072,	C709
ML092	C711
ML102	C713
ML112	C706
ML122	C706
ML132	C707
ML142	C707
ML162	C708
ML172	C711
SEM845	C229
SEM846	C156
SEM846	C166
SEMD98	C150
SEMD99	C169
SEME01	C196
SEME35	C218
SEME35	C221
SEME35	C222
SEME36	C238
SEME61	C177
SEME64	C203
SEME70	C223
SEME71	C240
SEME72	C244
SEME73	C250
SEME75	C255
SGED27	C498
SGED28	C497
SGED29	C500
SGED30	C503
SGED31	C502
XMB110A	C42
XMB110D	C43
XMB120C	C42
XMB130A	C43
XMB260T	C42
XMF110V	C49
XMM110V	C43
XMR110A	C44
XMR110D	C49
XMR120C	C44
XMR260T	C44
XSEMD98	C68
XSEME01	C71
XSEME36	C74
XSEME59	C69
XSEME60	C70
XSEME68	C72
XSEME75	C75
ZBC	C54

EDP No.	Page
ZBS	C55
ZBT	C56
ZMC	C76
ZMS	C77
ZMT	C78
ZRC	C57
ZRS	C58
ZRT	C58