

VAMATEC

THE PLACE TO BE FOR THE METAL INDUSTRY



LASSEN

CATALOGO 1.4

WWW.VAMATEC.BE

NEW BZL PRO-GRIP™ FEATURES AND BENEFITS



New Pro-Grip™ Handle System Ergonomically Superior

- Integrated soft grips ensure the handle remains in place with minimal grip pressure
- Enhances wire feeding performance
- Screwless design for rapid servicing

Cable Supports Improved Wire Feed

- The perfect balance of freedom of movement and progressive support to the power cable is achieved

Swan Necks

- High temperature resistant insulation materials reducing the risk of shorting
- Durable and Robust

Contact Tips

- Manufactured using a harder and higher conductivity copper alloy than the OEM

Hanger Hooks Easy to store

- Less prone to damage
- Encourages an efficient and tidy workspace

Knuckle Joint Improved Manoeuvrability

- Small movements of the handle and neck are possible independently of the cable assembly

Nozzles Maximises Performance

- Maximum wall thickness gives longevity and superior performance
- Manufactured to the same specifications as the OEM

Hydroflex™ Cable Systems

- Liquid cooled cable systems use high temperature resistant rubber cables which ensure leak free terminations

Hyperflex™ Cable Systems

- Air cooled cable assemblies offer outstanding flexibility and the highest heat and abrasion resistance of any known cable
- Cable end crimp systems ensure maximum conductivity whilst the outer jacket is constructed from cross linked polymers providing a tear proof jacket and a burn threshold of 375°C

Machine End Systems

- Extra length cable support systems
- Smooth and consistent wire feed
- Simple snap fits

Gun Plug Bodies

- Spring loaded pins
- Guaranteed gas seals

Quality Standards

All torches are rigorously tested using computerised and automated test equipment at the design stage through to production.

All our components pass rigorous quality control checks prior to assembly.

All torches are designed to be tough and damage resistant and comply with EN60974-7.



BZL GASMONDSTUKKEN

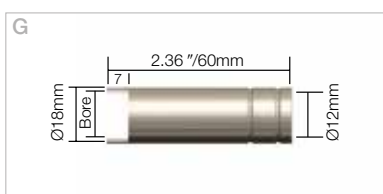
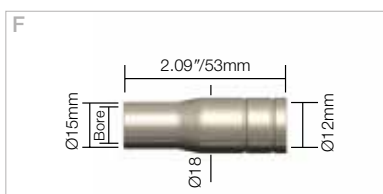
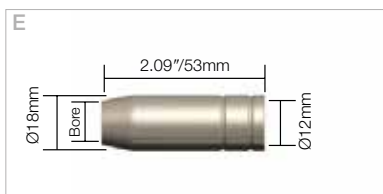
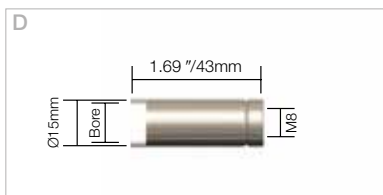
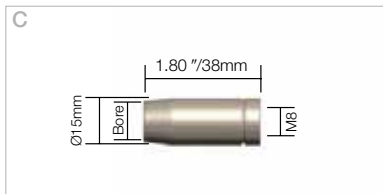
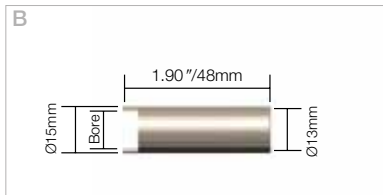
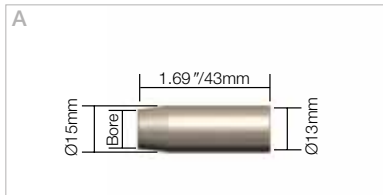

NOZZLES

Stock Code	Description	Bore	Bore	Model
A B1430-P	Conical Nozzle - Push On	7/16"	11mm	SB120A

Stock Code	Description	Bore	Bore	Model
B B1430-S	Spot Welding Nozzle - Push On	1/2"	13mm	SB120A

Stock Code	Description	Bore	Bore	Model
C B1430	Conical Nozzle - Screw On	7/16"	11mm	SB120A
B1430L	Conical Nozzle- 43mm long	7/16"	11mm	SB120A

Stock Code	Description	Bore	Bore	Model
D B1431	Spot Welding Nozzle - Screw On	1/2"	13mm	SB120A

Stock Code	Description	Bore	Bore	Model
E B1529	Cylindrical Nozzle	5/8"	16mm	SB140A, SB150A
B1530	Conical Nozzle	15/32"	12mm	SB140A, SB150A
B1531	Tapered Nozzle	7/16"	11mm	SB140A, SB150A

Stock Code	Description	Bore	Bore	Model
F B1532	Bottle Nozzle	1/2"	13mm	SB140A, SB150A

Stock Code	Description	Bore	Bore	Model
G B1533	Spot Welding Nozzle	5/8"	16mm	SB140A, SB150A

Stock Code	Description	Bore	Bore	Model
H B2415	Cylindrical Nozzle	11/16"	17mm	SB230A, SB240A, SB240W
B2416	Conical Nozzle	1/2"	13mm	SB230A, SB240A, SB240W
B2417	Tapered Nozzle	3/8"	10mm	SB230A, SB240A, SB240W

BZL GASMONDSTUKKEN



NOZZLES

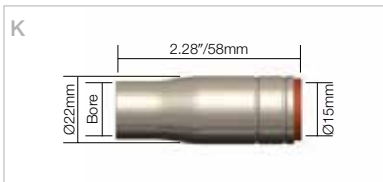
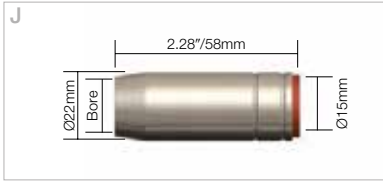

Stock Code	Description	Bore	Bore	Model
J B2507	Cylindrical Nozzle	5/7"	18mm	SB250A, SB350W
B2508	Conical Nozzle	19/32"	15mm	SB250A, SB350W
B2509	Tapered Nozzle	15/32"	12mm	SB250A, SB350W

Stock Code	Description	Bore	Bore	Model
K B2510	Bottle Nozzle	19/32"	15mm	SB250A, SB350W

Stock Code	Description	Bore	Bore	Model
L B2511	Spot Welding Nozzle	5/7"	18mm	SB250A, SB350W

Stock Code	Description	Bore	Bore	Model
M B3615	Cylindrical Nozzle	3/4"	19mm	SB360A
B3616	Conical Nozzle	5/8"	16mm	SB360A
B3617	Tapered Nozzle	15/32"	12mm	SB360A

Stock Code	Description	Bore	Bore	Model
N B4017	Conical Nozzle	5/7"	18mm	SB400A

Stock Code	Description	Bore	Bore	Model
O B5027	Cylindrical Nozzle	3/4"	19mm	SB380A-501W
B5028	Conical Nozzle	5/8"	16mm	SB380A-501W
B5029	Tapered Nozzle	9/16"	14mm	SB380A-501W

Stock Code	Description	Bore	Bore	Model
P B5028HD	Heavy Duty Conical Nozzle	5/8"	16mm	SB380A, SB401W, SB501W

Stock Code	Description	Bore	Bore	Model
Q B6004	Conical Nozzle	25/32"	20mm	SB610A, SB610W
B6005	Cylindrical Nozzle	29/32"	23mm	SB610A, SB610W

BZL CONTACTTIPS

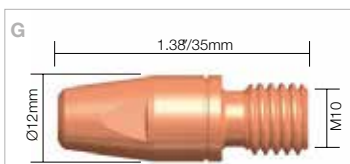
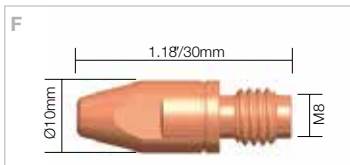
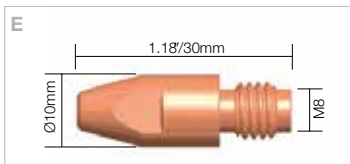
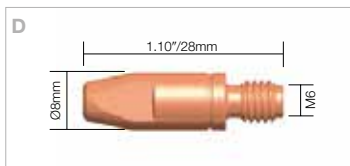
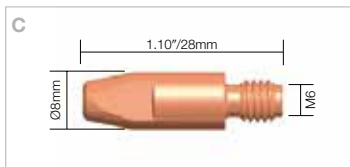
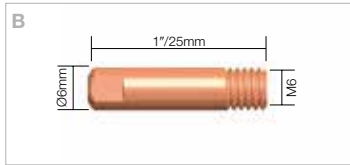
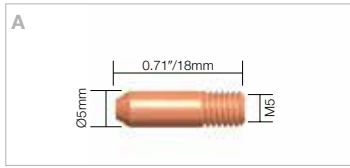

TIPS

Stock Code	Description	Wire Size	Wire Size	Material	Model
A B1427-06	Contact Tip	.023"	0.6mm	Ecu	SB120A
B1427-08	Contact Tip	.030"	0.8mm	Ecu	SB120A
B1427-10	Contact Tip	.040"	1.0mm	Ecu	SB120A

Stock Code	Description	Wire Size	Wire Size	Material	Model
B B1527-06	Contact Tip	.023"	0.6mm	Ecu	SB140A, SB150A
B1527-08	Contact Tip	.030"	0.8mm	Ecu	SB140A, SB150A
B1527-09	Contact Tip	.035"	0.9mm	Ecu	SB140A, SB150A
B1527-10	Contact Tip	.040"	1.0mm	Ecu	SB140A, SB150A
B1527-12	Contact Tip	.045"	1.2mm	Ecu	SB140A, SB150A

Stock Code	Description	Wire Size	Wire Size	Material	Model
C B2504-06	Contact Tip	.023"	0.6mm	Ecu	SB230A-350W
B2504-08	Contact Tip	.030"	0.8mm	Ecu	SB230A-350W
B2504-09	Contact Tip	.035"	0.9mm	Ecu	SB230A-350W
B2504-10	Contact Tip	.040"	1.0mm	Ecu	SB230A-350W
B2504-12	Contact Tip	.045"	1.2mm	Ecu	SB230A-350W
B2504-14	Contact Tip	.055"	1.4mm	Ecu	SB230A-350W
B2504-16	Contact Tip	1/16"	1.6mm	Ecu	SB230A-350W
B2504-08CR	Contact Tip, Cr Plated	.030"	0.8mm	Ecu	SB230A-350W
B2504-10CR	Contact Tip, Cr Plated	.040"	1.0mm	Ecu	SB230A-350W
B2504-12CR	Contact Tip, Cr Plated	.045"	1.2mm	Ecu	SB230A-350W
B2504-10A	Contact Tip, Ali Wire	.040"	1.0mm	Ecu	SB230A-350W
B2504-12A	Contact Tip, Ali Wire	.045"	1.2mm	Ecu	SB230A-350W
B2504-16A	Contact Tip, Ali Wire	1/16"	1.6mm	Ecu	SB230A-350W

Stock Code	Description	Wire Size	Wire Size	Material	Model
D B2505-08	Contact Tip	.030"	0.8mm	CuCrZr	SB230A-350W
B2505-09	Contact Tip	.035"	0.9mm	CuCrZr	SB230A-350W
B2505-10	Contact Tip	.040"	1.0mm	CuCrZr	SB230A-350W
B2505-12	Contact Tip	.045"	1.2mm	CuCrZr	SB230A-350W
B2505-16	Contact Tip	1/16"	1.6mm	CuCrZr	SB230A-350W

Stock Code	Description	Wire Size	Wire Size	Material	Model
E B4014-08	Contact Tip	.030"	0.8mm	Ecu	SB360A-SB501W
B4014-09	Contact Tip	.035"	0.9mm	Ecu	SB360A-SB501W
B4014-10	Contact Tip	.040"	1.0mm	Ecu	SB360A-SB501W
B4014-12	Contact Tip	.045"	1.2mm	Ecu	SB360A-SB501W
B4014-14	Contact Tip	.055"	1.4mm	Ecu	SB360A-SB501W
B4014-16	Contact Tip	1/16"	1.6mm	Ecu	SB360A-SB501W
B4014-20	Contact Tip	5/64"	2.0mm	Ecu	SB360A-SB501W
B4014-24	Contact Tip	3/32"	2.4mm	Ecu	SB360A-SB501W
B4014-10CR	Contact Tip, Cr Plated	.040"	1.0mm	Ecu	SB360A-SB501W
B4014-12CR	Contact Tip, Cr Plated	.045"	1.2mm	Ecu	SB360A-SB501W
B4014-10A	Contact Tip, Ali Wire	.040"	1.0mm	Ecu	SB360A-SB501W
B4014-12A	Contact Tip, Ali Wire	.045"	1.2mm	Ecu	SB360A-SB501W
B4014-16A	Contact Tip, Ali Wire	1/16"	1.6mm	Ecu	SB360A-SB501W

Stock Code	Description	Wire Size	Wire Size	Material	Model
F B4015-08	Contact Tip	.030"	0.8mm	CuCrZr	SB360A-SB501W
B4015-10	Contact Tip	.040"	1.0mm	CuCrZr	SB360A-SB501W
B4015-12	Contact Tip	.045"	1.2mm	CuCrZr	SB360A-SB501W
B4015-14	Contact Tip	.055"	1.4mm	CuCrZr	SB360A-SB501W
B4015-16	Contact Tip	1/16"	1.6mm	CuCrZr	SB360A-SB501W
B4015-24	Contact Tip	3/32"	2.4mm	CuCrZr	SB360A-SB501W

Stock Code	Description	Wire Size	Wire Size	Material	Model
G B6015-14	Contact Tip	.055"	1.4mm	CuCrZr	SB610A, SB610W
B6015-16	Contact Tip	1/16"	1.6mm	CuCrZr	SB610A, SB610W
B6015-20	Contact Tip	5/64"	2.0mm	CuCrZr	SB610A, SB610W
B6015-24	Contact Tip	3/32"	2.4mm	CuCrZr	SB610A, SB610W
B6015-28	Contact Tip	.110"	2.8mm	CuCrZr	SB610A, SB610W
B6015-32	Contact Tip	1/8"	3.2mm	CuCrZr	SB610A, SB610W

CONTACTTIPHOUDERS

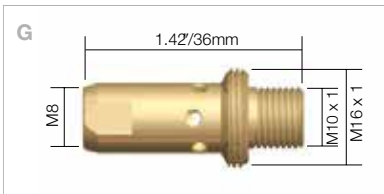
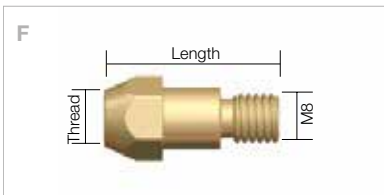
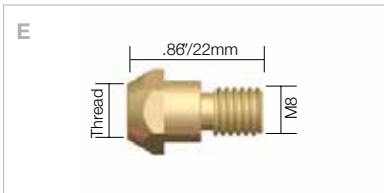
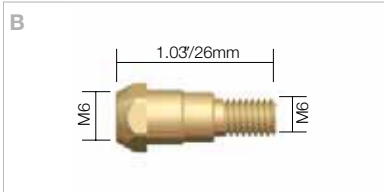
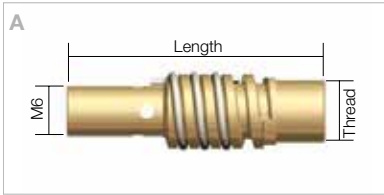

TIP ADAPTERS

Stock Code	Description	Tip Thread	Neck Thread	Model	Length	Length
A B1507 L/H	Tip Adaptor	M6	M8x1 L/H	SB150A	1.65"	42mm
B1507	Tip Adaptor	M6	M8x1	SB140A	1.34"	34mm

Stock Code	Description	Tip Thread	Neck Thread	Model
B B2412	Tip Adaptor	M6	M6	SB230A, SB240A/W

Stock Code	Description	Tip Thread	Neck Thread	Model
C B2506	Tip Adaptor	M6	M8	SB250A, SB350W
ECO2506	Everyday Tip Adaptor	M6	M8	SB250A, SB350W

Stock Code	Description	Tip Thread	Neck Thread	Model
D B2536	Tip Adaptor	M8	M8	SB250A, SB350W

Stock Code	Description	Tip Thread	Neck Thread	Model
E B2612	Tip Adaptor	M6	M8	SB260A
B2612M8	Tip Adaptor	M8	M8	SB260A

Stock Code	Description	Tip Thread	Length	Length	Neck Thread	Model
F B3612	Tip Adaptor	M6	1.12"	28.5mm	M8	SB360A
ECO3612	Everyday Tip Adaptor	M6	1.12"	28.5mm	M8	SB360A
B3613	Tip Adaptor	M6	1.24"	31.5mm	M8	SB360A
B3614	Tip Adaptor	M8	1.12"	28.5mm	M8	SB360A
ECO3614	Everyday Tip Adaptor	M8	1.12"	28.5mm	M8	SB360A

Stock Code	Description	Tip Thread	Neck Thread	Model
G B3812	Tip Adaptor	M8	M10 x 1	SB380A

Stock Code	Description	Tip Thread	Neck Thread	Model
H B4005	Tip Adaptor	M8	M8	SB400A

TIP ADAPTERS

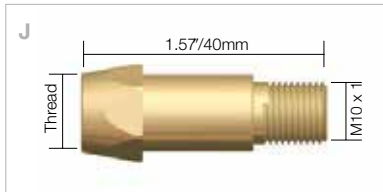
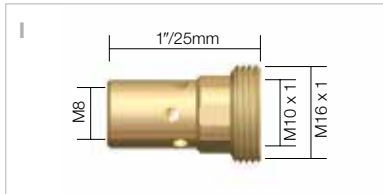

Stock Code	Description	Tip Thread	Neck Thread	Model
I B5001	Tip Adaptor	M8	M10 x 1	SB401W, SB501W
ECO5001	Everyday Tip Adaptor	M8	M10 x 1	SB401W, SB501W

Stock Code	Description	Tip Thread	Neck Thread	Model
J B6003	Tip Adaptor	M8	M10 x 1	SB610A, SB610W
B6003M10	Tip Adaptor	M10	M10 x 1	SB610A, SB610W



BZL GASVERDELERS



DIFFUSERS

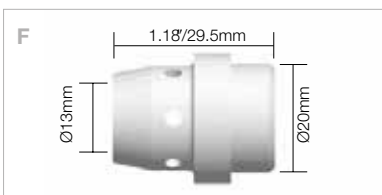
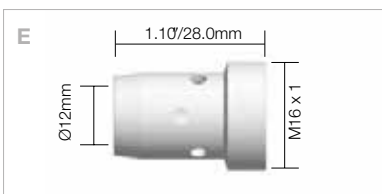
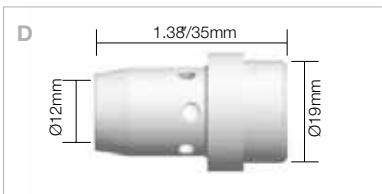
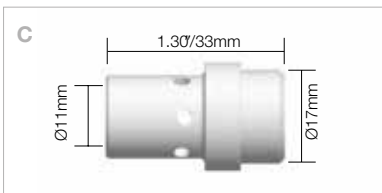
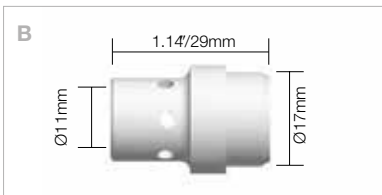
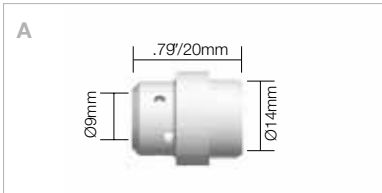

Stock Code	Description	Colour	Model
A B2405B	Diffuser	Black	SB240A, SB240W
B2405C	Diffuser	Ceramic	SB240A, SB240W
B2405W	Diffuser	White	SB240A, SB240W

Stock Code	Description	Colour	Model
B B2605B	Diffuser	Black	SB260A
B2605C	Diffuser	Ceramic	SB260A
B2605W	Diffuser	White	SB260A

Stock Code	Description	Colour	Model
C B3605B	Diffuser	Black	SB360A
B3605C	Diffuser	Ceramic	SB360A
B3605W	Diffuser	White	SB360A

Stock Code	Description	Colour	Model
D B4003B	Diffuser	Black	SB400A
B4003C	Diffuser	Ceramic	SB400A

Stock Code	Description	Colour	Model
E B5005B	Diffuser	Black	SB380A, SB401W, SB501W
B5005C	Diffuser	Ceramic	SB380A, SB401W, SB501W
B5005W	Diffuser	White	SB380A, SB401W, SB501W

Stock Code	Description	Colour	Model
F B6002C	Diffuser	Ceramic	SB610A, SB610W

GELEIDINGSSPIRALEN



Stock Code	Description	Length	Wire Size	Model	SB120A	SB140A	SB150A	SB230A	SB240A	SB250A	SB260A	SB360A	SB380A	SB400A	SB610A	SB240W	SB350W	SB401W	SB501W	SB610W
A B1435-30	Steel Liner	3mt	.023"-.030"/0.6mm-0.8mm		■	□	□	□	□	□	□	□	□	□	□	□	□	□	□	□
B1435-40	Steel Liner	4mt	.023"-.030"/0.6mm-0.8mm		■	□	□	□	□	□	□	□	□	□	□	□	□	□	□	□
B1435-20TEL	Steel Liner (Telwin)	2mt	.023"-.030"/0.6mm-0.8mm		■	□	□													
B1435-30TEL	Steel Liner (Telwin)	3mt	.023"-.030"/0.6mm-0.8mm		■	□	□													
B1436-30	Nylon Liner	3mt	.023"-.035"/0.6mm-0.9mm		■	□	□													
B1436-40	Nylon Liner	4mt	.023"-.035"/0.6mm-0.9mm		■	□	□													
B ECO / B1535-30	Steel Liner	3mt	.023"-.035"/0.6mm-0.9mm		■	■	■	■	■	■	■	■	□	□		□	□	□	□	□
ECO / B1535-40	Steel Liner	4mt	.023"-.035"/0.6mm-0.9mm		■	■	■	■	■	■	■	■	□	□		□	□	□	□	□
B1535-50	Steel Liner	5mt	.023"-.035"/0.6mm-0.9mm		■	■	■	■	■	■	■	■	□	□		□	□	□	□	□
B1535-20TEL	Steel Liner (Telwin)	2mt	.023"-.035"/0.6mm-0.9mm		■	■														
B1535-30TEL	Steel Liner (Telwin)	3mt	.023"-.035"/0.6mm-0.9mm		■	■														
C B1536-30++	Teflon Liner	3mt	.023"-.035"/0.6mm-0.9mm		■	■	■	■	■	■	■	■	□	□		■	■	□	□	□
B1536-40++	Teflon Liner	4mt	.023"-.035"/0.6mm-0.9mm		■	■	■	■	■	■	■	■	□	□		■	■	□	□	□
B1536-50++	Teflon Liner	5mt	.023"-.035"/0.6mm-0.9mm		■	■	■	■	■	■	■	■	□	□		■	■	□	□	□
B ECO / B2524-30	Steel Liner	3mt	.040"-.045"/1.0mm-1.2mm		□	□	□	□	□	□	□	□	□	□		□	□	□	□	□
ECO / B2524-40	Steel Liner	4mt	.040"-.045"/1.0mm-1.2mm		□	□	□	□	□	□	□	□	□	□		□	□	□	□	□
B2524-50	Steel Liner	5mt	.040"-.045"/1.0mm-1.2mm		□	□	□	□	□	□	□	□	□	□		□	□	□	□	□
C B2513-30++	Teflon Liner	3mt	.040"-.045"/1.0mm-1.2mm		□	□	□	□	□	□	□	□	□	□		□	□	□	□	□
B2513-40++	Teflon Liner	4mt	.040"-.045"/1.0mm-1.2mm		□	□	□	□	□	□	□	□	□	□		□	□	□	□	□
B2513-50++	Teflon Liner	5mt	.040"-.045"/1.0mm-1.2mm		□	□	□	□	□	□	□	□	□	□		□	□	□	□	□
B B3631-30	Steel Liner	3mt	1/16"/1.6mm		□	□	□	□	□	□	■	■	■	■		□	□	□	□	□
B3631-40	Steel Liner	4mt	1/16"/1.6mm		□	□	□	□	□	□	■	■	■	■		□	□	□	□	□
B3631-50	Steel Liner	5mt	1/16"/1.6mm		□	□	□	□	□	□	■	■	■	■		□	□	□	□	□
C B3626-30++	Teflon Liner	3mt	.045"-1/16"/1.2mm-1.6mm					□	□	□	□	□	□	□		□	□	□	□	□
B3626-40++	Teflon Liner	4mt	.045"-1/16"/1.2mm-1.6mm					□	□	□	□	□	□	□		□	□	□	□	□
B3626-50++	Teflon Liner	5mt	.045"-1/16"/1.2mm-1.6mm					□	□	□	□	□	□	□		□	□	□	□	□
B B4631-30	Steel Liner	3mt	5/64"-3/32"/2.0mm-2.4mm												■					
B4631-40	Steel Liner	4mt	5/64"-3/32"/2.0mm-2.4mm												■					
B4631-50	Steel Liner	5mt	5/64"-3/32"/2.0mm-2.4mm												■					
D B6033-30	Plain Liner (Rz-2)	3mt	1/16"-5/64"/1.6mm-2.0mm												■					■
B6033-40	Plain Liner (Rz-2)	4mt	1/16"-5/64"/1.6mm-2.0mm												■					■
B6033-50	Plain Liner (Rz-2)	5mt	1/16"-5/64"/1.6mm-2.0mm												■					■
D B6034-30	Plain Liner (Rz-2)	3mt	3/32"/2.4mm												■					■
B6034-40	Plain Liner (Rz-2)	4mt	3/32"/2.4mm												■					■
D B6035-30	Plain Liner (Rz-2)	3mt	.110"-1/8"/2.8mm-3.2mm												■					■
B6035-40	Plain Liner (Rz-2)	4mt	.110"-1/8"/2.8mm-3.2mm												■					■
B B5033-30	Plain Liner	3mt	.040"-.045"/1.0mm-1.2mm													■	■	■	■	
B5033-40	Plain Liner	4mt	.040"-.045"/1.0mm-1.2mm													■	■	■	■	
B5033-50	Plain Liner	5mt	.040"-.045"/1.0mm-1.2mm													■	■	■	■	
B B5034-30	Plain Liner	3mt	.045"-1/16"/1.2mm-1.6mm													□	□	■	■	
B5034-40	Plain Liner	4mt	.045"-1/16"/1.2mm-1.6mm													□	□	■	■	
B5034-50	Plain Liner	5mt	.045"-1/16"/1.2mm-1.6mm													□	□	■	■	
A B4033-30	Plain Liner	3mt	5/64"-3/32"/2.0mm-2.4mm													□	□	□	■	
B4033-40	Plain Liner	4mt	5/64"-3/32"/2.0mm-2.4mm													□	□	□	■	
B4033-50	Plain Liner	5mt	5/64"-3/32"/2.0mm-2.4mm													□	□	□	■	
C B1564-30++	Polyamide Liner	3mt	.030"-.045"/0.8mm-1.2mm		■	■	■	■	■	■	■	■	■	■		■	■	□	□	□
B1564-40++	Polyamide Liner	4mt	.030"-.045"/0.8mm-1.2mm		■	■	■	■	■	■	■	■	■	■		■	■	□	□	□
B1564-50++	Polyamide Liner	5mt	.030"-.045"/0.8mm-1.2mm		■	■	■	■	■	■	■	■	■	■		■	■	□	□	□
C B2564-30++	Polyamide Liner	3mt	.045"-1/16"/1.2mm-1.6mm				□	□	□	□	□	□	□	□		□	□	■	■	■
B2564-40++	Polyamide Liner	4mt	.045"-1/16"/1.2mm-1.6mm				□	□	□	□	□	□	□	□		□	□	■	■	■
B2564-50++	Polyamide Liner	5mt	.045"-1/16"/1.2mm-1.6mm				□	□	□	□	□	□	□	□		□	□	■	■	■
C B3564-30++	Polyamide Liner	3mt	1/16"-5/64"/1.6mm-2.0mm				□	□	□	□	□	□	□	□		□	□	■	■	■
B3564-40++	Polyamide Liner	4mt	1/16"-5/64"/1.6mm-2.0mm				□	□	□	□	□	□	□	□		□	□	■	■	■
B3564-50++	Polyamide Liner	5mt	1/16"-5/64"/1.6mm-2.0mm				□	□	□	□	□	□	□	□		□	□	■	■	■
C B2554-30++	Carbon Teflon Liner	3mt	.040"-.045"/1.0mm-1.2mm		■	■	■	■	■	■	■	■	■	■		■	■	□	□	□
B2554-40++	Carbon Teflon Liner	4mt	.040"-.045"/1.0mm-1.2mm		■	■	■	■	■	■	■	■	■	■		■	■	□	□	□
B2554-50++	Carbon Teflon Liner	5mt	.040"-.045"/1.0mm-1.2mm		■	■	■	■	■	■	■	■	■	■		■	■	□	□	□
C B3554-30++	Carbon Teflon Liner	3mt	.045"-1/16"/1.2mm-1.6mm				□	□	□	□	□	□	□	□		□	□	■	■	■
B3554-40++	Carbon Teflon Liner	4mt	.045"-1/16"/1.2mm-1.6mm				□	□	□	□	□	□	□	□		□	□	■	■	■
B3554-50++	Carbon Teflon Liner	5mt	.045"-1/16"/1.2mm-1.6mm				□	□	□	□	□	□	□	□		□	□	■	■	■

■ Solid Box = Recommended Liner □ Clear Box = Compatible Liner ++ For optional Neck Liners please use the following codes.
 B9000 for soft wires .030"-.045"/0.8mm-1.0mm, B9001 for .040"-1/16"/1.0mm-1.6mm

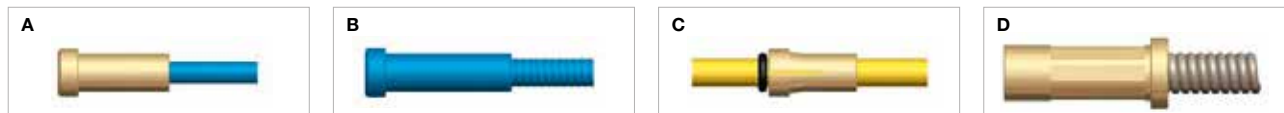

SB 120A



AIR COOLED MIG WELDING TORCH

Rating: 140A CO2 120A mixed gas, @ 60% duty cycle. EN60974-7 / 0.6mm-0.8mm wires

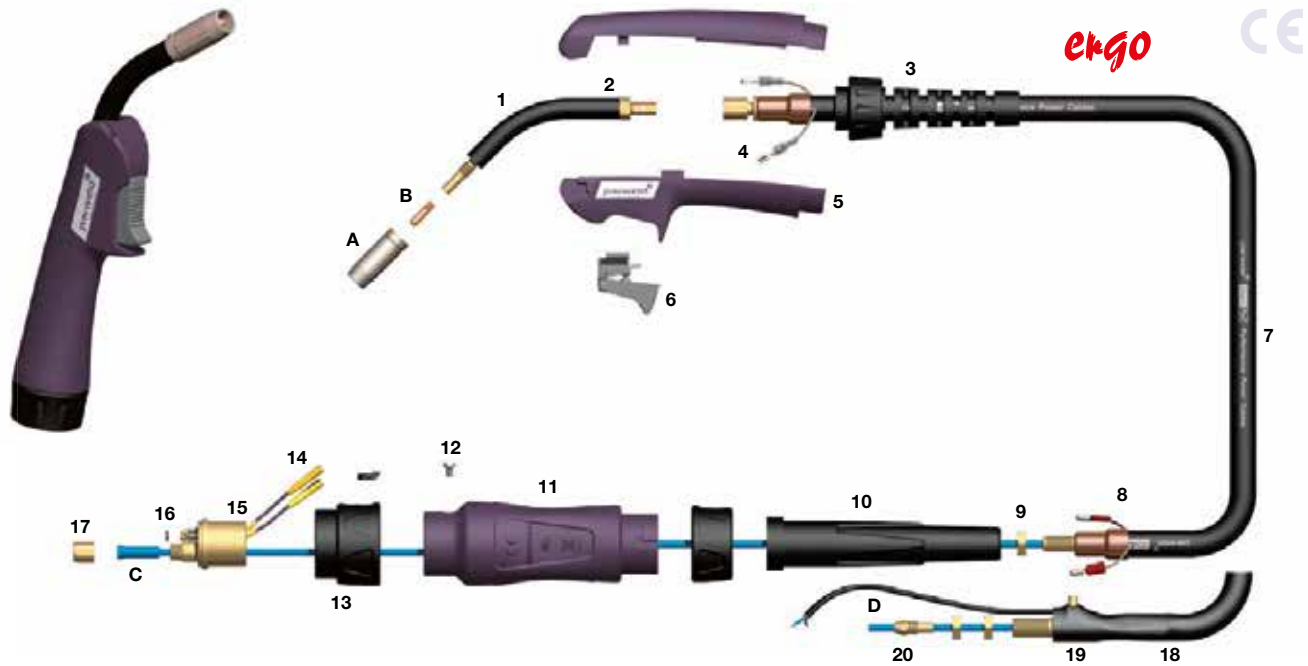

MODEL

Stock Code	3M	4M	Model Description
B1200	-30ER	-40ER	Welding Torch c/w Euro Fitting
B1200	-30TEL	N/A	Welding Torch c/w Telwin Termination

NOZZLES

Stock Code	Description
A B1430*	Conical Nozzle Screw On 7/16"/11mm Bore
B1431	Spot Welding Nozzle Screw On 1/2"/13mm Bore

CONTACT TIPS

Stock Code	Description
B B1427-06*	Contact Tip .023"/0.6mm M5 Ecu
B1427-08	Contact Tip .030"/0.8mm M5 Ecu

LINERS

Stock Code	Description
C B1435-30*	Steel Liner .023"- .030"/0.6-0.8mm x 3mt
B1435-40*	Steel Liner .023"- .035"/0.6-0.8mm x 4mt
B1436-30	Nylon Liner .023"- .035"/0.6-0.8mm x 3mt
B1436-40	Nylon Liner .023"- .035"/0.6-0.8mm x 4mt
D B1535-30TEL	Steel Liner .023"- .035"/0.6-0.8mm x 3mt
B1535-40TEL	Steel Liner .023"- .035"/0.6-0.8mm x 4mt

COMPONENTS

Stock Code	Description	* Denotes Standard Build
1 B1401	Swan Neck-Screw On Nozzle	
NI B1401-P	Swan Neck - Push On Nozzle	
2 B1402	Insulation Sleeve	
3 B8011	Cable Support	
4 B1521	Cable Terminal	
5 B1414	Ergo Handle Kit c/w Lock Nut and Trigger	
6 B1416	Ergo Trigger	
7 B1317-30	Hyperflex Cable Assembly x 3mt	
B1317-40	Hyperflex Cable Assembly x 4mt	
8 B1522	Cable Terminal Male	
9 B1505	Lock Nut	
10 B1841	Cable Support	
11 B1518	Gun Plug Housing c/w Nut	
12 B1526	Gun Plug Screw	
13 B1519PL	Gun Plug Nut-c/w Insert	
14 Spring Pin 2	Spring Pin Assembly	
15 B1528	Gun Plug Body c/w Spring Pins	
16 B1524	Gun Plug 'O' Ring	
17 B1525	Liner Nut	
18 B1251	Strain Relief	
19 B1217-30TEL	Hyperflex Cable Assy x 3mt Telwin	
20 B1552	Liner Collet	

SB 140A



AIR COOLED MIG WELDING TORCH

Rating: 160A CO2 140A mixed gas @ 60% duty cycle EN60974-7 / 0.6mm-0.9mm wires

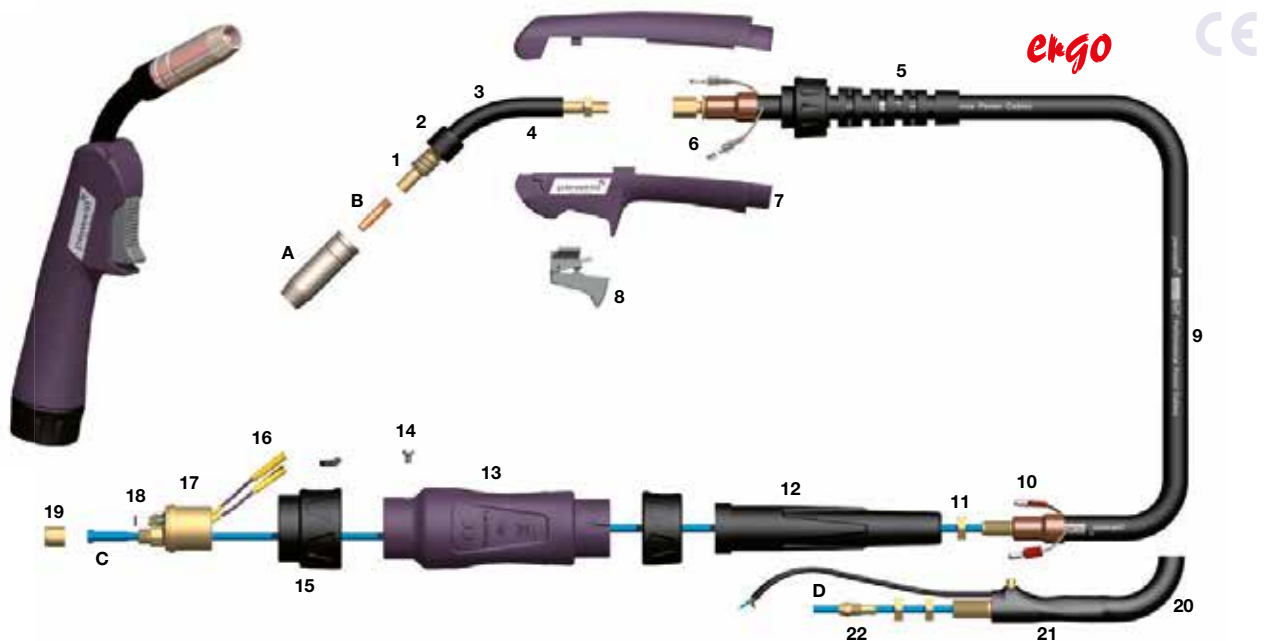

MODEL

Stock Code	3M	4M	Model Description
B1400	-30ER	40ER	Welding Torch c/w Euro Fitting
B1400	-30TEL	N/A	Welding Torch c/w Telwin Termination

NOZZLES

Stock Code	Description
A B1529	Cylindrical Nozzle 5/8"/16mm Bore
B1530*	Conical Nozzle 15/32"/12mm Bore
B1531	Tapered Nozzle 7/16"/11mm Bore
B1532	Bottle Nozzle 1/2"/13mm Bore
B1533	Spot Welding Nozzle 5/8"/16mm Bore

CONTACT TIPS

Stock Code	Description
B B1527-06	Contact Tip .023"/0.6mm M6 Ecu
B1527-08*	Contact Tip .030"/0.8mm M6 Ecu
B1527-09	Contact Tip .035"/0.9mm M6 Ecu

LINERS

Stock Code	Description
C B1535-30*	Steel Liner .023"- .035"/0.6-0.9mm x 3mt
B1535-40*	Steel Liner .023"- .035"/0.6-0.9mm x 4mt
B1536-30	Teflon Liner .023"- .035"/0.6-0.9mm x 3mt
B1536-40	Teflon Liner .023"- .035"/0.6-0.9mm x 4mt
D B1535-30TEL	Steel Liner .023"- .035"/0.6-0.9mm x 3mt
B1535-40TEL	Steel Liner .023"- .035"/0.6-0.9mm x 4mt

COMPONENTS

Stock Code	Description	* Denotes Standard Build
1 B1504	Shroud Spring	
2 B1503	Insulator	
3 B1502	Insulation Sleeve	
4 B1415	Swan Neck	
5 B8011	Cable Support	
6 B1521	Cable Terminal	
7 B1414	Ergo Handle Kit c/w Lock Nut and Trigger	
8 B1416	Ergo Trigger	
9 B1417-30	Hyperflex Cable Assembly x 3mt	
B1417-40	Hyperflex Cable Assembly x 4mt	
10 B1522	Cable Terminal Male	
11 B1505	Lock Nut	
12 B1841	Cable Support	
13 B1518	Gun Plug Housing c/w Nut	
14 B1526	Gun Plug Screw	
15 B1519PL	Gun Plug Nut c/w Insert	
16 Spring Pin 2	Spring Pin Assembly	
17 B1528	Gun Plug Body c/w Spring Pins	
18 B1524	Gun Plug 'O' Ring	
19 B1525	Liner Nut	
20 B1251	Strain Relief	
21 B1217-30TEL	Hyperflex Cable Assy x 3mt Telwin	
22 B1552	Liner Collet	

SB 150A



AIR COOLED MIG WELDING TORCH

Rating: 180A CO2 150A mixed gas @ 60% duty cycle, EN60974-7 / 0.6mm-1.0mm wires

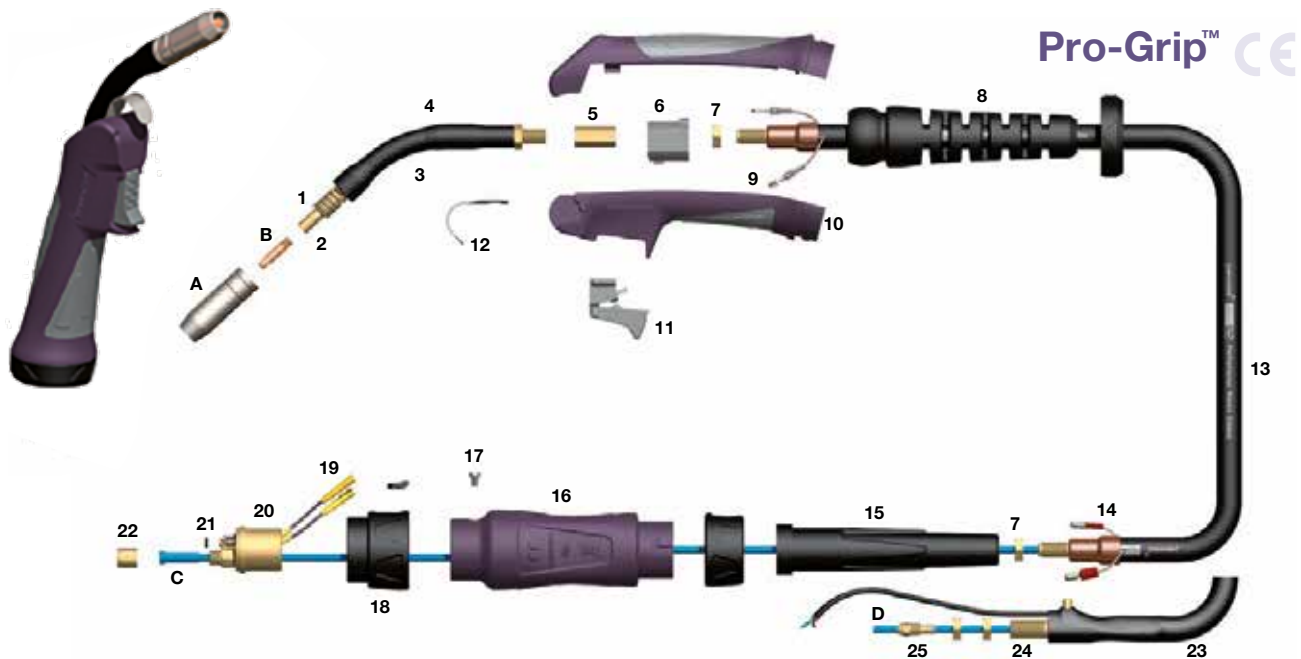

MODEL

Stock Code	3M	4M	5M	Model Description
PRO1500	-30ER	-40ER	-50ER	Welding Torch c/w Ergo Handle
PRO1500	-30TEL	-40TEL	-50TEL	Welding Torch c/w Telwin Fitting

NOZZLES

Stock Code	Description
A B1529	Cylindrical Nozzle 5/8"/16mm Bore
B1530*	Conical Nozzle 15/32"/12mm Bore
B1531	Tapered Nozzle 7/16"/11mm Bore
B1532	Bottle Nozzle 1/2"/13mm Bore
B1533	Spot Welding Nozzle 5/8"/16mm Bore

CONTACT TIPS

Stock Code	Description
B B1527-06	Contact Tip .023"/0.6mm M6 Ecu
B1527-08*	Contact Tip .030"/0.8mm M6 Ecu
B1527-09	Contact Tip .035"/0.9mm M6 Ecu
B1527-10	Contact Tip .040"/1.0mm M6 Ecu

LINERS

Stock Code	Description
C B1535-30*	Steel Liner .023"- .035"/0.6-0.9mm x 3mt
B1535-40*	Steel Liner .023"- .035"/0.6-0.9mm x 4mt
B1535-50*	Steel Liner .023"- .035"/0.6-0.9mm x 5mt
B1536-30	Teflon Liner .023"- .035"/0.6-0.9mm x 3mt
B1536-40	Teflon Liner .023"- .035"/0.6-0.9mm x 4mt
B1536-50	Teflon Liner .023"- .035"/0.6-0.9mm x 5mt
D B1535-40TEL	Steel Liner .023"- .035"/0.6-0.9mm x 4mt
B1535-50TEL	Steel Liner .023"- .035"/0.6-0.9mm x 5mt

COMPONENTS

Stock Code	Description	* Denotes Standard Build
1 B1504	Shroud Spring	
2 B1507 L/H	Tip Adaptor	
3 B1501	Swan Neck c/w Tip Adaptor, Spring and Sleeve	
4 B1502	Insulation Sleeve	
5 B2519	Hexagonal Fitting	
6 B1515/ER	Ergo Handle Location Body	
7 B1505	Lock Nut	
8 B8015	Cable Support c/w Knuckle Joint	
9 B1521	Cable Terminal	
10 B7514	Pro-Grip Handle Kit	
11 B2516	Ergo Trigger	
12 B2517	Hanger Hook	
13 B1517-30	Hyperflex Cable Assembly x 3mt	
B1517-40	Hyperflex Cable Assembly x 4mt	
B1517-50	Hyperflex Cable Assembly x 5mt	
14 B1522	Cable Terminal Male	
15 B1841	Cable Support	
16 B1518	Gun Plug Housing c/w Nut	
17 B1526	Gun Plug Screw	
18 B1519PL	Gun Plug Nut c/w Insert	
19 Spring Pin 2	Spring Pin Assembly	
20 B1528	Gun Plug Body c/w Spring Pins	
21 B1524	Gun Plug 'O' Ring	
22 B1525	Liner Nut	
23 B1251	Strain Relief	
24 B1517-30TEL	Hyperflex Cable Assembly x 3mt Telwin	
B1517-40TEL	Hyperflex Cable Assembly x 4mt Telwin	
25 B1552	Liner Collet	

SB 240A



AIR COOLED MIG WELDING TORCH

Rating: 250A CO2 220A mixed gas @ 60% duty cycle, EN60974-7 / 0.8mm-1.2mm wires

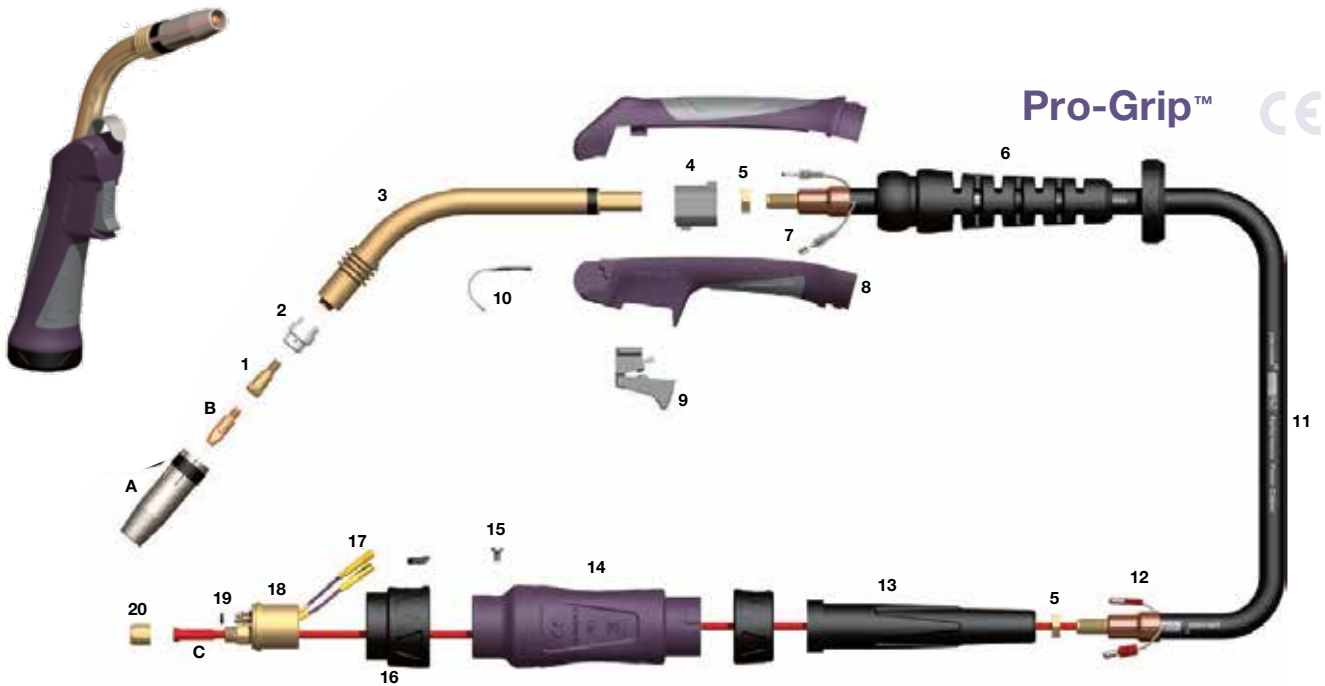

MODEL

Stock Code	3M	4M	5M	Model Description
PRO2400	-30ER	-40ER	-50ER	Welding Torch c/w Ergo Handle

LINERS

Stock Code	Description
B2513-30	Teflon Liner .040"-.045"/1.0-1.2mm x 3mt
B2513-40	Teflon Liner .040"-.045"/1.0-1.2mm x 4mt
B2513-50	Teflon Liner .040"-.045"/1.0-1.2mm x 5mt

NOZZLES

Stock Code	Description
A B2415	Cylindrical Nozzle 43/64"/17mm Bore
B2416*	Conical Nozzle 1/2"/13mm Bore
B2417	Tapered Nozzle 3/8"/10mm Bore

COMPONENTS

Stock Code	Description	* Denotes Standard Build
1 B2412	Tip Adaptor	
2 B2405B	Diffuser Black	
B2405C*	Diffuser Ceramic	
B2405W	Diffuser White	
3 B2401	Swan Neck	
4 B1515/ER	Ergo Handle Location Body	
5 B1505	Lock Nut	
6 B8015	Cable Support c/w Knuckle Joint	
7 B1521	Cable Terminal	
8 B7514	Pro-Grip Handle Kit	
9 B2516	Ergo Trigger	
10 B2517	Hanger Hook	
11 B2603-30	Hyperflex Cable Assembly x 3mt	
B2603-40	Hyperflex Cable Assembly x 4mt	
B2603-50	Hyperflex Cable Assembly x 5mt	
12 B1522	Cable Terminal Male	
13 B2841	Cable Support	
14 B1518	Gun Plug Housing c/w Nut	
15 B1526	Gun Plug Screw	
16 B1519	Gun Plug Nut c/w Insert	
17 Spring Pin 2	Spring Pin Assembly	
18 B1528	Gun Plug Body c/w Spring Pins	
19 B1524	Gun Plug 'O' Ring	
20 B1525	Liner Nut	

CONTACT TIPS

Stock Code	Description
B B2504-08	Contact Tip .030"/0.8mm M6 Ecu
B2504-09	Contact Tip .035"/0.9mm M6 Ecu
B2504-10*	Contact Tip .040"/1.0mm M6 Ecu
B2504-12	Contact Tip .045"/1.2mm M6 Ecu
B2505-08	Contact Tip .030"/0.8mm M6 CuCrZr
B2505-09	Contact Tip .035"/0.9mm M6 CuCrZr
B2505-10	Contact Tip .040"/1.0mm M6 CuCrZr
B2505-12	Contact Tip .045"/1.2mm M6 CuCrZr

LINERS

Stock Code	Description
C B1535-30	Steel Liner .023"-.035"/0.6-0.9mm x 3mt
B1535-40	Steel Liner .023"-.035"/0.6-0.9mm x 4mt
B1535-50	Steel Liner .023"-.035"/0.6-0.9mm x 5mt
B2524-30*	Steel Liner .040"-.045"/1.0-1.2mm x 3mt
B2524-40*	Steel Liner .040"-.045"/1.0-1.2mm x 4mt
B2524-50*	Steel Liner .040"-.045"/1.0-1.2mm x 5mt
B1536-30	Teflon Liner .023"-.035"/0.6-0.9mm x 3mt
B1536-40	Teflon Liner .023"-.035"/0.6-0.9mm x 4mt
B1536-50	Teflon Liner .023"-.035"/0.6-0.9mm x 5mt

SB 250A



AIR COOLED MIG WELDING TORCH

Rating: 230A CO2 200 A mixed gas @ 60% duty cycle, EN60974-7 / 0.8mm-1.2mm wires

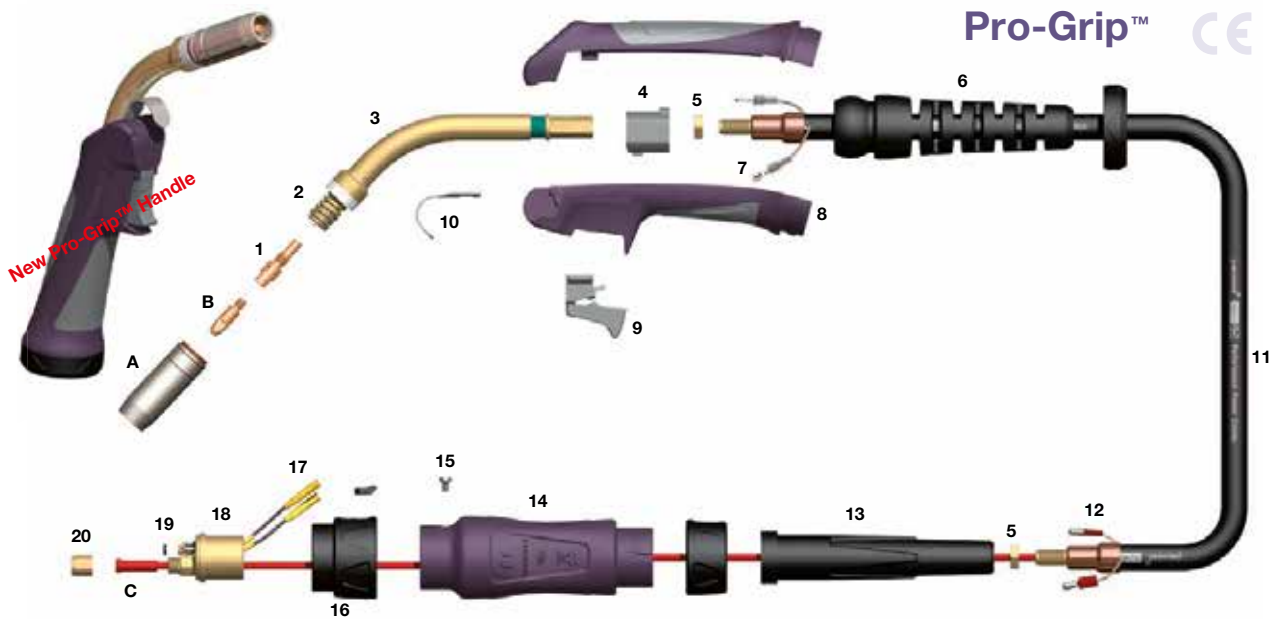

MODEL

Stock Code	3M	4M	5M	Model Description
PRO2500	-30ER	-40ER	-50ER	Welding Torch c/w Ergo Handle

NOZZLES

Stock Code	Description
A B2507	Cylindrical Nozzle 1 1/16"/18mm Bore
B2508*	Conical Nozzle 19/32"/15mm Bore
B2509	Tapered Nozzle 15/32"/12mm Bore
B2510	Bottle Nozzle 19/32"/15mm Bore
B2511	Spot Welding Nozzle 1 1/16"/18mm Bore

CONTACT TIPS

Stock Code	Description
B B2504-08	Contact Tip .030"/0.8mm M6 Ecu
B2504-09	Contact Tip .035"/0.9mm M6 Ecu
B2504-10*	Contact Tip .040"/1.0mm M6 Ecu
B2504-12	Contact Tip .045"/1.2mm M6 Ecu
B2505-08	Contact Tip .030"/0.8mm M6 CuCrZr
B2505-09	Contact Tip .035"/0.9mm M6 CuCrZr
B2505-10	Contact Tip .040"/1.0mm M6 CuCrZr
B2505-12	Contact Tip .045"/1.2mm M6 CuCrZr

LINERS

Stock Code	Description
C B1535-30	Steel Liner .023"- .035"/0.6-0.9mm x 3mt
B1535-40	Steel Liner .023"- .035"/0.6-0.9mm x 4mt
B1535-50	Steel Liner .023"- .035"/0.6-0.9mm x 5mt
B2524-30*	Steel Liner .040"- .045"/1.0-1.2mm x 3mt
B2524-40*	Steel Liner .040"- .045"/1.0-1.2mm x 4mt
B2524-50*	Steel Liner .040"- .045"/1.0-1.2mm x 5mt
B1536-30	Teflon Liner .023"- .035"/0.6-0.9mm x 3mt
B1536-40	Teflon Liner .023"- .035"/0.6-0.9mm x 4mt
B1536-50	Teflon Liner .023"- .035"/0.6-0.9mm x 5mt
B2513-30	Teflon Liner .040"- .045"/1.0-1.2mm x 3mt
B2513-40	Teflon Liner .040"- .045"/1.0-1.2mm x 4mt
B2513-50	Teflon Liner .040"- .045"/1.0-1.2mm x 5mt

COMPONENTS

Stock Code	Description	* Denotes Standard Build
1 B2506*	Tip Adaptor M6	
NI B2536	Tip Adaptor M8	
2 B2502	Shroud Spring	
3 B2501	Swan Neck	
4 B1515/ER	Ergo Handle Location Body	
5 B1505	Lock Nut	
6 B8015	Cable Support c/w Knuckle Joint	
7 B1521	Cable Terminal	
8 B7514	Pro-Grip Handle Kit	
9 B2516	Ergo Trigger	
10 B2517	Hanger Hook	
11 B2503-30	Hyperflex Cable Assembly x 3mt	
B2503-40	Hyperflex Cable Assembly x 4mt	
B2503-50	Hyperflex Cable Assembly x 5mt	
12 B1522	Cable Terminal Male	
13 B2841	Cable Support	
14 B1518	Gun Plug Housing c/w Nut	
15 B1526	Gun Plug Screw	
16 B1519	Gun Plug Nut c/w Insert	
17 Spring Pin 2	Spring Pin Assembly	
18 B1528	Gun Plug Body c/w Spring Pins	
19 B1524	Gun Plug 'O' Ring	
20 B1525	Liner Nut	

SB 260A



AIR COOLED MIG WELDING TORCH

Rating: 250A C02 220A mixed gas @ 60% duty cycle, EN60974-7 / 0.8mm-1.2mm wires

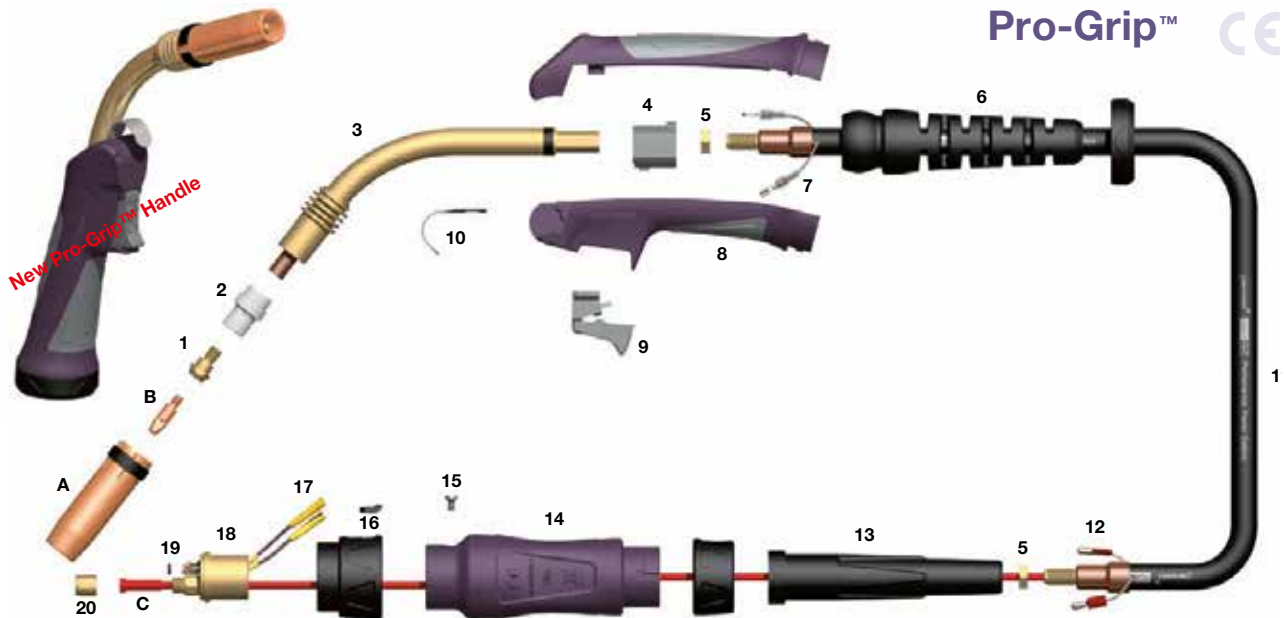

MODEL

Stock Code	3M	4M	5M	Model Description
PRO2600	-30ER	-40ER	-50ER	Welding Torch c/w Ergo Handle

NOZZLES

Stock Code	Description
A B5027	Cylindrical Nozzle 3/4"/19mm Bore
B5028*	Conical Nozzle 5/8"/16mm Bore
B5029	Tapered Nozzle 9/16"/14mm Bore

CONTACT TIPS

Stock Code	Description
B B2504-08	Contact Tip .030"/0.8mm M6 Ecu
B2504-09	Contact Tip .035"/0.9mm M6 Ecu
B2504-10	Contact Tip .040"/1.0mm M6 Ecu
B2504-12*	Contact Tip .045"/1.2mm M6 Ecu
B2505-08	Contact Tip .030"/0.8mm M6 CuCrZr
B2505-09	Contact Tip .035"/0.9mm M6 CuCrZr
B2505-10	Contact Tip .040"/1.0mm M6 CuCrZr
B2505-12	Contact Tip .045"/1.2mm M6 CuCrZr

LINERS

Stock Code	Description
C B2524-30*	Steel Liner .040"- .045"/1.0-1.2mm x 3mt
B2524-40*	Steel Liner .040"- .045"/1.0-1.2mm x 4mt
B2524-50*	Steel Liner .040"- .045"/1.0-1.2mm x 5mt
B2513-30	Teflon Liner .040"- .045"/1.0-1.2mm x 3mt
B2513-40	Teflon Liner .040"- .045"/1.0-1.2mm x 4mt
B2513-50	Teflon Liner .040"- .045"/1.0-1.2mm x 5mt

COMPONENTS

Stock Code	Description	* Denotes Standard Build
1 B2612	Tip Adaptor M6	
NI B2612M8	Tip Adaptor M8	
2 B2605B	Diffuser Black	
B2605C*	Diffuser Ceramic	
B2605W	Diffuser White	
3 B2601	Swan Neck	
4 B1515/ER	Ergo Handle Location Body	
5 B1505	Lock Nut	
6 B8015	Cable Support c/w Knuckle Joint	
7 B1521	Cable Terminal	
8 B7514	Pro-Grip Handle Kit	
9 B2516	Ergo Trigger	
10 B2517	Hanger Hook	
11 B2603-30	Hyperflex Cable Assembly x 3mt	
B2603-40	Hyperflex Cable Assembly x 4mt	
B2603-50	Hyperflex Cable Assembly x 5mt	
12 B1522	Cable Terminal Male	
13 B2841	Cable Support	
14 B1518	Gun Plug Housing c/w Nut	
15 B1526	Gun Plug Screw	
16 B1519	Gun Plug Nut c/w Insert	
17	Spring Pin Assembly	
18 B1528	Gun Plug Body c/w Spring Pins	
19 B1524	Gun Plug 'O' Ring	
20 B1525	Liner Nut	

SB 360A



AIR COOLED MIG WELDING TORCH

Rating: 300A CO2 270A mixed gas, EN60974-7 @ 60% duty cycle / 0.8mm-1.2mm wires

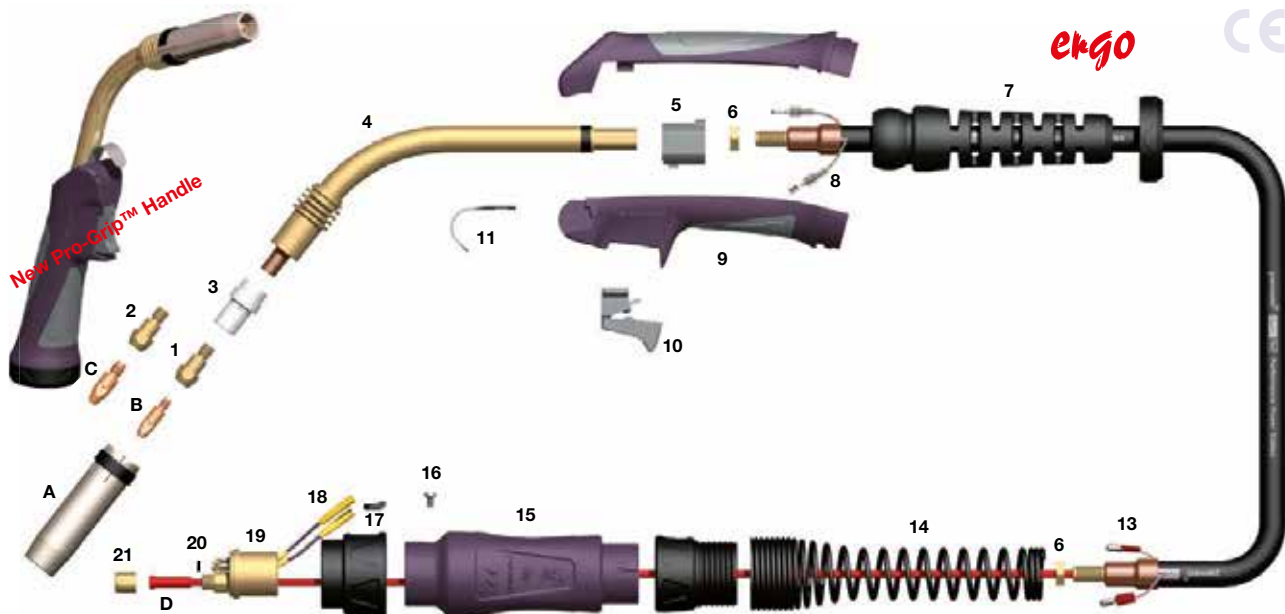

MODEL

Stock Code	3M	4M	5M	Model Description
PRO3600	-30ER	-40ER	-50ER	Welding Torch c/w Ergo Handle

NOZZLES

Stock Code	Description
A B3615	Cylindrical Nozzle 3/4"/19mm Bore
B3616*	Conical Nozzle 5/8"/16mm Bore
B3617	Tapered Nozzle 15/32"/12mm Bore

CONTACT TIPS

Stock Code	Description
B B2504-10	Contact Tip .040"/1.0mm M6 Ecu
B2504-12*	Contact Tip .045"/1.2mm M6 Ecu
B2505-10	Contact Tip .040"/1.0mm M6 CuCrZr
B2505-12	Contact Tip .045"/1.2mm M6 CuCrZr
C B4014-10	Contact Tip .040"/1.0mm M8 Ecu
B4014-12	Contact Tip .045"/1.2mm M8 Ecu
B4015-10	Contact Tip .040"/1.0mm M8 CuCrZr
B4015-12	Contact Tip .045"/1.2mm M8 CuCrZr

LINERS

Stock Code	Description
D B2524-30*	Steel Liner .040"- .045"/1.0-1.2mm x 3mt
B2524-40*	Steel Liner .040"- .045"/1.0-1.2mm x 4mt
B2524-50*	Steel Liner .040"- .045"/1.0-1.2mm x 5mt
B2513-30	Teflon Liner .040"- .045"/1.0-1.2mm x 3mt
B2513-40	Teflon Liner .040"- .045"/1.0-1.2mm x 4mt
B2513-50	Teflon Liner .040"- .045"/1.0-1.2mm x 5mt

COMPONENTS

Stock Code	Description	* Denotes Standard Build
1 B3612*	Tip Adaptor 28.5mm M6	
2 B3614	Tip Adaptor 28.5mm M8	
NI B3613	Tip Adaptor 31.5mm M6	
3 B3605B	Diffuser Black	
B3605C*	Diffuser Ceramic	
B3605W	Diffuser White	
4 B3603	Swan Neck	
5 B1515/ER	Ergo Handle Location Body	
6 B1505	Lock Nut	
7 B8016	Cable Support c/w Knuckle Joint	
8 B1521	Cable Terminal	
9 B7514	Pro-Grip Handle Kit	
10 B2516	Ergo Trigger	
11 B2517	Hanger Hook	
12 B3609-30	Hyperflex Cable Assembly x 3mt	
B3609-40	Hyperflex Cable Assembly x 4mt	
B3609-50	Hyperflex Cable Assembly x 5mt	
13 B1522	Cable Terminal Male	
14 B8026	Spring Cable Support	
15 B1518	Gun Plug Housing c/w Nut	
16 B1526	Gun Plug Screw	
17 B1519	Gun Plug Nut c/w insert	
18 Spring Pin 2	Spring Pin Assembly	
19 B1528	Gun Plug Body c/w Spring Pins	
20 B1524	Gun Plug 'O' Ring	
21 B1525	Liner Nut	

NI Not Illustrated.

SB 401W



WATER COOLED MIG WELDING TORCH

Rating: 400A CO2 350A mixed gas @ 100% duty cycle, EN60974-7 / 0.8mm-1.2mm wires

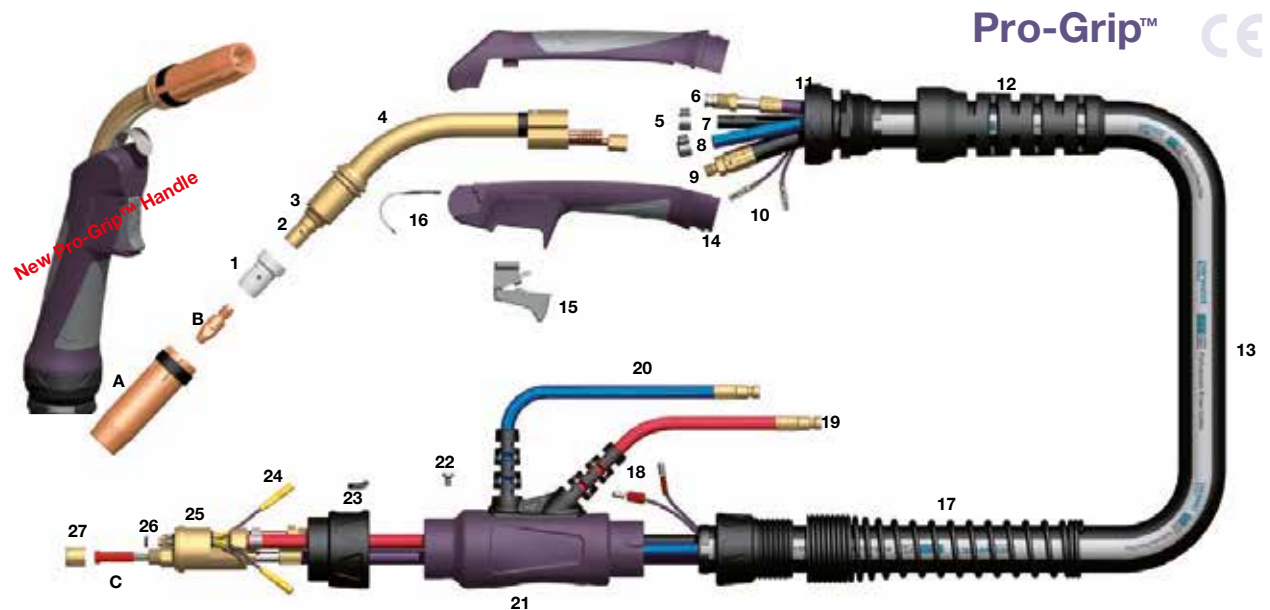

MODEL

Stock Code	3M	4M	5M	Model Description
PRO4001	-30ER	-40ER	-50ER	Welding Torch c/w Ergo Handle

NOZZLES

Stock Code	Description
A B5027	Cylindrical Nozzle 3/4"/19mm Bore
B5028*	Conical Nozzle 5/8"/16mm Bore
B5029	Tapered Nozzle 9/16"/14mm Bore

CONTACT TIPS

Stock Code	Description
B B4014-08	Contact Tip .030"/0.8mm M8 Ecu
B4014-10	Contact Tip .040"/1.0mm M8 Ecu
B4014-12*	Contact Tip .045"/1.2mm M8 Ecu
B4015-10	Contact Tip .040"/1.0mm M8 CuCrZr
B4015-12	Contact Tip .045"/1.2mm M8 CuCrZr

LINERS

Stock Code	Description
C B5033-30*	Plain Liner .040"- .045"/1.0-1.2mm x 3mt
B5033-40*	Plain Liner .040"- .045"/1.0-1.2mm x 4mt
B5033-50*	Plain Liner .040"- .045"/1.0-1.2mm x 5mt
B2513-30	Teflon Liner .040"- .045"/1.0-1.2mm x 3mt
B2513-40	Teflon Liner .040"- .045"/1.0-1.2mm x 4mt
B2513-50	Teflon Liner .040"- .045"/1.0-1.2mm x 5mt

COMPONENTS

Stock Code	Description	* Denotes Standard Build
1 B5005B	Diffuser Black	
B5005C*	Diffuser Ceramic	
B5005W	Diffuser White	
2 B5001	Tip Adaptor 25.0mm M8	
3 B5003	Insulating Washer	
4 B4011	Swan Neck	
5 B5024	Water Hose Clamp 9.5mm	
11 B8031	Ball Joint Assembly c/w Clamp	
12 B8032	Spring Cable Support c/w Adaptor	
14 B7594	Pro-Grip Handle Kit	
15 B2516	Ergo Trigger	
16 B2517	Hanger Hook	
17 B8027	Spring Cable Support	
18 B1522	Cable Terminal Male	
19 B5023	Water Hose Nipple	
20 B5017	Water Outlet Hose O/Braid	
21 B5022	Gun Plug Housing c/w Lock Nut and Hose Supports	
22 B1526	Gun Plug Screw	
23 B1519	Gun Plug Nut c/w Insert	
24 Spring Pin 2	Spring Pin Assembly	
25 B5098	Gun Plug Body c/w Spring Pins	
26 B1524	Gun Plug 'O' Ring	
27 B1525	Liner Nut	

CABLE ASSEMBLY

Stock Code	3M	4M	5M	Model Description
6 B5008	-30	-40	-50	Outer Liner Assembly
7 B5013	-30	-40	-50	Gas Hose Assembly
8 B5012	-30	-40	-50	Water Inlet Hose Assembly
9 B5015	-30	-40	-50	Power Cable Assembly
10 B5010	-30	-40	-50	Switch Lead Assembly
13 B5019	-30	-40	-50	Canvas Cover Assembly

SB 501W



WATER COOLED MIG WELDING TORCH

Rating: 520A CO2 430A mixed gas @ 100% duty cycle, EN60974-7 / 1.0mm-1.6mm wires

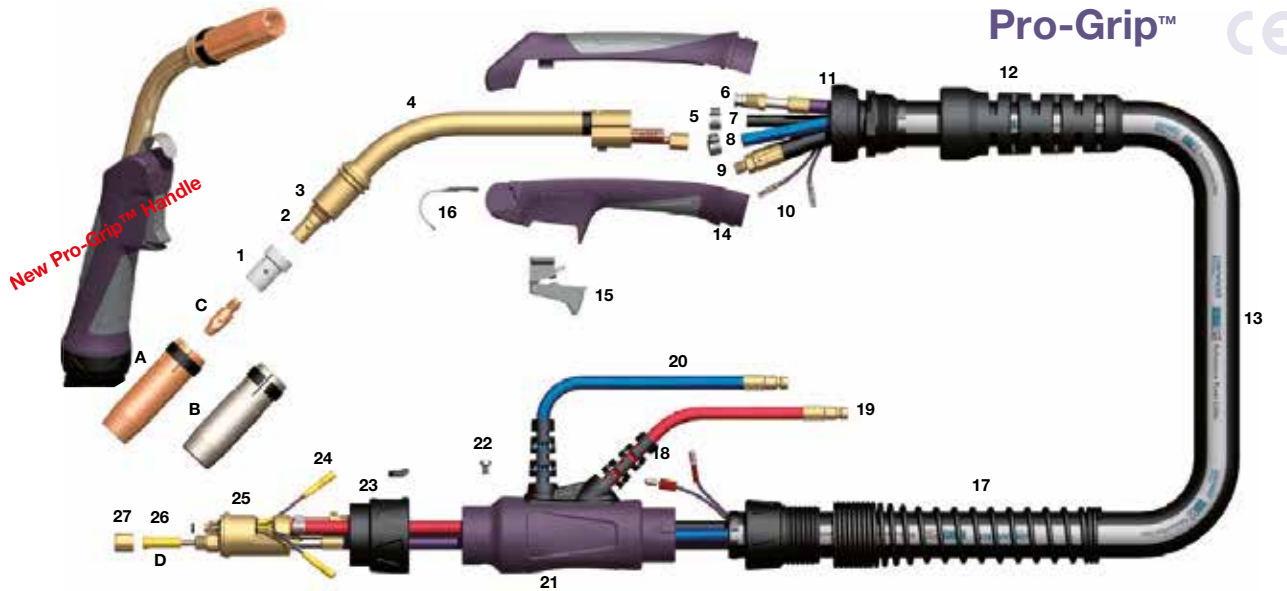

MODEL

Stock Code	3M	4M	5M	Model Description
PRO5000	-30ER	-40ER	-50ER	Welding Torch c/w Ergo Handle

NOZZLES

Stock Code	Description
A B5027	Cylindrical Nozzle 3/4"/19mm Bore
B5028*	Conical Nozzle 5/8"/16mm Bore
B5029	Tapered Nozzle 9/16"/14mm Bore
B B5028HD	Heavy Duty Conical Nozzle 5/8"/16mm Bore

CONTACT TIPS

Stock Code	Description
C B4014-10	Contact Tip .040"/1.0mm M8 Ecu
B4014-12*	Contact Tip .045"/1.2mm M8 Ecu
B4014-16	Contact Tip 1/16"/1.6mm M8 Ecu
B4015-10	Contact Tip .040"/1.0mm M8 CuCrZr
B4015-12	Contact Tip .045"/1.2mm M8 CuCrZr
B4015-16	Contact Tip 1/16"/1.6mm M8 CuCrZr

LINERS

Stock Code	Description
D B5033-30	Plain Liner .040"- .045"/1.0-1.2mm x 3mt
B5033-40	Plain Liner .040"- .045"/1.0-1.2mm x 4mt
B5033-50	Plain Liner .040"- .045"/1.0-1.2mm x 5mt
B5034-30*	Plain Liner .045"-1/16"/1.2-1.6mm x 3mt
B5034-40*	Plain Liner .045"-1/16"/1.2-1.6mm x 4mt
B5034-50*	Plain Liner .045"-1/16"/1.2-1.6mm x 5mt
B2513-30	Teflon Liner .040"- .045"/1.0-1.2mm x 3mt
B2513-40	Teflon Liner .040"- .045"/1.0-1.2mm x 4mt
B2513-50	Teflon Liner .040"- .045"/1.0-1.2mm x 5mt
B3626-30	Teflon Liner .045"-1/16"/1.2-1.6mm x 3mt
B3626-40	Teflon Liner .045"-1/16"/1.2-1.6mm x 4mt
B3626-50	Teflon Liner .045"-1/16"/1.2-1.6mm x 5mt

COMPONENTS

Stock Code	Description	* Denotes Standard Build
1 B5005B	Diffuser Black	
B5005C*	Diffuser Ceramic	
B5005W	Diffuser White	
2 B5001	Tip Adaptor 25.0mm M8	
3 B5003	Insulating Washer	
4 B5002	Swan Neck	
5 B5024	Water Hose Clamp 9.5mm	
11 B8031	Ball Joint Assembly c/w Clamp	
12 B8032	Spring Cable Support c/w Adaptor	
14 B7594	Pro-Grip Handle Kit	
15 B2516	Ergo Trigger	
16 B2517	Hanger Hook	
17 B8027	Spring Cable Support	
18 B1522	Cable Terminal Male	
19 B5023	Water Hose Nipple	
20 B5017	Water Outlet Hose O/Braid	
21 B5022	Gun Plug Housing c/w Lock Nut and Hose Supports	
22 B1526	Gun Plug Screw	
23 B1519	Gun Plug Nut c/w Insert	
24 Spring Pin 2	Spring Pin Assembly	
25 B5098	Gun Plug Body c/w Spring Pins	
26 B1524	Gun Plug 'O' Ring	
27 B1525	Liner Nut	

CABLE ASSEMBLY

Stock Code	3M	4M	5M	Model Description
6 B5008	-30	-40	-50	Outer Liner Assembly
7 B5013	-30	-40	-50	Gas Hose Assembly
8 B5012	-30	-40	-50	Water Inlet Hose Assembly
9 B5015	-30	-40	-50	Power Cable Assembly
10 B5010	-30	-40	-50	Switch Lead Assembly
13 B5019	-30	-40	-50	Canvas Cover Assembly

NEW PRO-GRIP™ TIG FEATURES & BENEFITS



Torch Heads

Lightweight and Durable

- Manufactured with high temperature resistant silicone rubber insulation.
- All copper components ensure cooler running temperatures and maximum current capacity.

Trigger Switches

Plug and Play™ Technology

- Located in a neutral finger position
- Switches can be changed within 5 seconds allowing lower inventory levels and an infinite degree of flexibility at point of sale.
- 6 Different switch options to suit every application.

Knuckle Joint

Improved Manoeuvrability

- Positioning of the torch is made easier by the combination of knuckle joints and a flexible leather section that covers the first metre of the torch immediately behind the handle.

Front End Consumables

Extensive Range

- Front end consumables are manufactured to the highest specifications.

New Pro-Grip™ Handle System

Ergonomically Superior

- Integrated dual soft grips ensure the handle remains in place with minimal grip pressure

Cable Systems

- Optimum cable performance and flexibility is guaranteed through the exclusive use of overbraided power cables.
- Switch leads are shielded as standard to ensure minimal interference and maximum machine protection.

A range of cable plugs is available to suit the majority of machines



Quality Standards

All torches are rigorously tested using computerised and automated test equipment at the design stage through to production.

All our components pass rigorous quality control checks prior to assembly.

All torches are designed to be tough and damage resistant and comply with EN60974-7.



NEW PRO-9 EN PRO-9FXL



AIR COOLED PRO-GRIP™ TIG WELDING TORCH

Rating: 125A DC, 100A AC @ 60% Duty Cycle, EN60974-7 .0209 to 3/329 0.5mm-2.4mm Electrodes

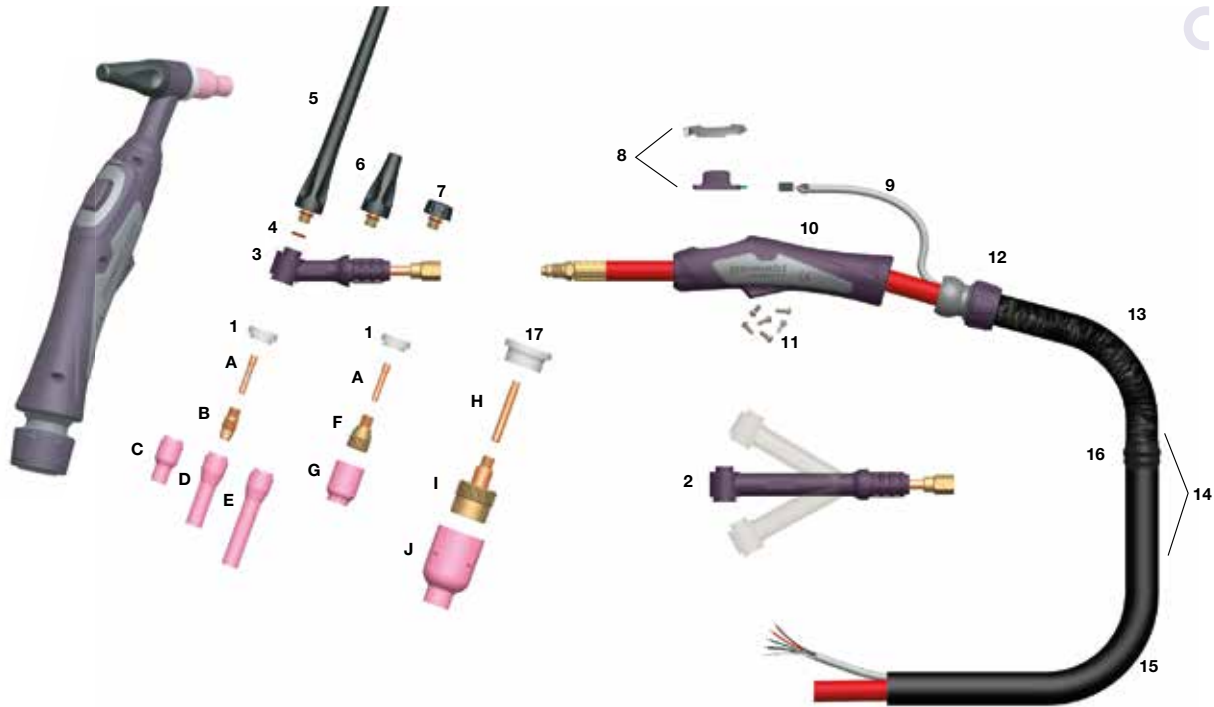

Torch Head

Stock Code	Description
PRO9	PRO9 Torch Head Air Cooled 125A DC
PRO9FXL	PRO9FXL Torch Head Flexible Air Cooled 125A DC

Cable Length

Stock Code	Description
12	12.5ft Cables (4m) c/w Leather Cover and Sheath
25	25ft Cables (8m) c/w Leather Cover and Sheath

Switch Option

Stock Code	Description
S1	Momentary Switch
S1L	Momentary Switch and Lever
S2	2 Button Momentary
S3	3 Button Momentary
S4	4 Switch Momentary Rocker Kit
1K	1 Button Momentary +1K Potentiometer
2K	1 Button Momentary +5K Potentiometer
3K	1 Button Momentary +10K Potentiometer
4K	1 Button Momentary +25K Potentiometer
N	Blank

Cable Termination

UK/European Cable Termination Stock Code	Description
BG	Single 3/8" BSP Connection
EG	Central Connector
WG	WTG Connector
LG	L-TEC Euro
BD	35-50 Dinse on Power 3/8" BSP on gas

USA Cable Termination

Stock Code	Description
US	Lug on power, 5/8" UNF RH Male on Gas
UN	Single 5/8" UNF RH male
UD	35-95 dinse on power, 5/8" UNF RH Male on Gas

Cable Plug

Stock Code	Description
0	2 Pin Amphenol Plug
1	4 Pin Amphenol Plug
2	5 Pin Amphenol Plug
3	6 Pin Amphenol Plug
4	14 Pin Amphenol Plug
5	6 Pin Harting Plug
6	8 Pin Thermal Arc Plug
7	3 Pin Tuchel Plug
8	9 Pin Tuchel Plug
9	5 Pin Tuchel Plug
10	12 Pin Bundy Plug
11	7 Pin Migatronic Plug
12	2 Pin XTI Inverter Plug
14	5 Pin XTI Inverter Plug

Standard Collet

Stock Code	Description
A 13N20	Standard Collet .020"/0.5mm Bore
13N21	Standard Collet .040"/1.0mm Bore
13N22	Standard Collet 1/16"/1.6mm Bore
13N22M	Standard Collet 5/64"/2.0mm Bore
13N23	Standard Collet 3/32"/2.4mm Bore

Standard Collet Body

Stock Code	Description
B 13N25	Standard Collet Body .020"/0.5mm Bore
13N26	Standard Collet Body .040"/1.0mm Bore
13N27	Standard Collet Body 1/16"/1.6mm Bore
13N27M	Standard Collet Body 5.64"/2.0mm Bore
13N28	Standard Collet Body 3/32"/2.4mm Bore

Standard Ceramic Cup

Stock Code	Description
C 13N08	Standard Ceramic Cup 1/4"/6mm Bore
13N09	Standard Ceramic Cup 5/16"/8mm Bore
13N10	Standard Ceramic Cup 3/8"/10mm Bore
13N11	Standard Ceramic Cup 7/16"/11mm Bore
13N12	Standard Ceramic Cup 1/2"/15mm Bore
13N13	Standard Ceramic Cup 5/8"/16mm Bore

Long Ceramic Cup

Stock Code	Description
D 796F70	Long Ceramic Cup 3/16"/5mm Bore
796F71	Long Ceramic Cup 1/4"/6mm Bore
796F72	Long Ceramic Cup 5/16"/8mm Bore
796F73	Long Ceramic Cup 3/8"/10mm Bore

Extra Long Ceramic Cup

Stock Code	Description
E 796F74	Extra Long Ceramic Cup 3/16"/5mm Bore
796F75	Extra Long Ceramic Cup 1/4"/6mm Bore
796F76	Extra Long Ceramic Cup 5/16"/8mm Bore
796F77	Extra Long Ceramic Cup 3/8"/10mm Bore

Gas Lens Body

Stock Code	Description
F 45V41	Gas Lens Body .020"/0.5mm Bore
45V42	Gas Lens Body .040"/1.0mm Bore
45V43	Gas Lens Body 1/16"/1.6mm Bore

Gas Lens Cup

Stock Code	Description
G 53N58	Standard Gas Lens Cup 1/4"/6mm Bore
53N59	Standard Gas Lens Cup 5/16"/6mm Bore
53N60	Standard Gas Lens Cup 3/8"/8mm Bore
53N61	Standard Gas Lens Cup 7/16"/10mm Bore
53N61-S	Standard Gas Lens Cup 1/2"/13mm Bore

Large Diameter Gas Lens Collet

Stock Code	Description
H 13N22L	Large Dia Gas Lens Collet 1/16"/1.6mm Bore
13N23L	Large Dia Gas Lens Collet 3/32"/2.4mm Bore

Large Diameter Gas Lens Body

Stock Code	Description
I 45V116S	Large Dia Gas Lens Body 1/16"/1.6mm Bore
45V64S	Large Dia Gas Lens Body 3/32"/2.4mm Bore

Large Diameter Gas Lens Cup

Stock Code	Description
J 57N75	Large Dia Gas Lens Cup 3/8"/10mm Bore
57N74	Large Dia Gas Lens Cup 1/2"/13mm Bore
53N88	Large Dia Gas Lens Cup 5/8"/16mm Bore
53N87	Large Dia Gas Lens Cup 3/4"/19mm Bore

Components

Stock Code	Description
1 598882	Cup Gasket
2 PRO9FXL	Torch Head Flexible
3 PRO9	Torch Head including Cup Gasket
4 98W77	Back Cap O Ring
5 PRO41V24	Pro-Grip™ Tig Back Cap Long
6 PRO41V35	Pro-Grip™ Tig Back Cap Medium
7 PRO41V33	Pro-Grip™ Tig Back Cap Small
8 PRO1MS	Momentary Switch Kit (fitted as Standard) Alternative switch options are listed on Page 137
9 PROSWL4	Switch & Leads x 4mt/12.5ft
PROSWL8	Switch & Leads x 8mt/25ft
10 PROH100	Pro-Grip™ Tig Handle Small
11 PROSP	Screw Pack
12 PROKJ100	Knuckle Joint c/w Lock Nut
13 PROLC100-08	Leather Cover x 0.8mt/2.6ft
14 PROCO100-40	Complete Cover Assembly x 4mt/12.5ft
PROCO100-80	Complete Cover Assembly x 8mt/25ft
15 PRONC32	Neoprene Cover x 3.2mt/10.5ft
PRONC72	Neoprene Cover x 7.2mt/23.6ft
16 PROJK100	Jointing Repair Kit
17 54N63-20	Insulator Large Diameter Gas Lens

NEW PRO-17 EN PRO-17FX



AIR COOLED PRO-GRIP™ TIG WELDING TORCH

Rating: 150A DC, 115A AC @ 60% Duty Cycle, EN60974-7 0.0409 to 1/89/0.5mm-3.2mm Electrodes

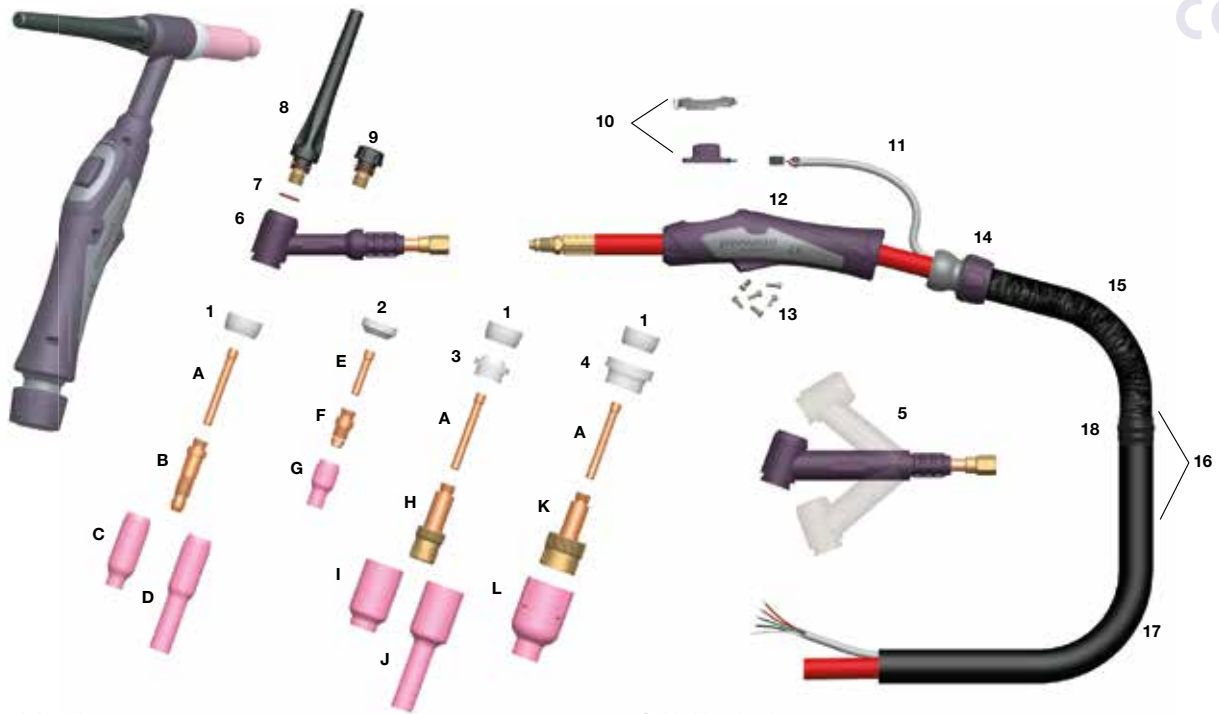

Torch Head

Stock Code	Description
PRO17	PRO17 Torch Head Air Cooled 150A DC
PRO17FX	PRO17FX Torch Head Flexible Air Cooled 150A DC

Cable Length

Stock Code	Description
12	12.5ft Cables (4m) c/w Leather Cover and Neoprene Sheath
25	25ft Cables (8m) c/w Leather Cover and Neoprene Sheath

Switch Option

Stock Code	Description
S1	Momentary Switch
S1L	Momentary Switch and Lever
S2	2 Button Momentary
S3	3 Button Momentary
S4	4 Switch Momentary Rocker Kit
1K	1 Button Momentary +1K Potentiometer
2K	1 Button Momentary +5K Potentiometer
3K	1 Button Momentary +10K Potentiometer
4K	1 Button Momentary +25K Potentiometer
N	Blank

Cable Termination

UK/European Cable Termination Stock Code	Description
BG	Single 3/8" BSP Connection
EG	Central Connector
WG	WTG Connector
LG	L-TEC Euro
BD	35-50 Dinse on Power 3/8" BSP on gas

USA Cable Termination

Stock Code	Description
US	Lug on power, 5/8" UNF RH Male on Gas
UN	Single 5/8" UNF RH male
UD	35-95 dinse on power, 5/8" UNF RH Male on Gas

Cable Plug

Stock Code	Description
0	2 Pin Amphenol Plug
1	4 Pin Amphenol Plug
2	5 Pin Amphenol Plug
3	6 Pin Amphenol Plug
4	14 Pin Amphenol Plug
5	6 Pin Harting Plug
6	8 Pin Thermal Arc Plug
7	3 Pin Tuchel Plug
8	9 Pin Tuchel Plug
9	5 Pin Tuchel Plug
10	12 Pin Bundy Plug
11	7 Pin Migatronc Plug
12	2 Pin XTI Inverter Plug
14	5 Pin XTI Inverter Plug

Standard Collet

Stock Code	Description
A 10N21	Standard Collet 0.020"/0.5mm Bore
10N22	Standard Collet 0.040"/1.0mm Bore
10N23	Standard Collet 1/16"/1.6mm Bore
10N23M	Standard Collet 5/64"/2.0mm Bore
10N24	Standard Collet 3/32"/2.4mm Bore
10N25	Standard Collet 1/8"/3.2mm Bore
54N20	Standard Collet 5/32"/4.0mm Bore

Standard Collet Body

Stock Code	Description
B 10N29	Standard Collet Body .020"/0.5mm Bore
10N30	Standard Collet Body .040"/1.0mm Bore
10N31	Standard Collet Body 1/16"/1.6mm Bore
10N32	Standard Collet Body 3/32"/2.4mm Bore
10N28	Standard Collet Body 1/8"/3.2mm Bore
406488	Standard Collet Body 5/32"/4.0mm Bore

Standard Ceramic Cup

Stock Code	Description
C 10N50	Standard Ceramic Cup 1/4"/6mm Bore
10N49	Standard Ceramic Cup 5/16"/8mm Bore
10N48	Standard Ceramic Cup 3/8"/10mm Bore
10N47	Standard Ceramic Cup 7/16"/11mm Bore
10N46	Standard Ceramic Cup 1/2"/13mm Bore
10N45	Standard Ceramic Cup 5/8"/16mm Bore
10N44	Standard Ceramic Cup 3/4"/19mm Bore

Standard Long Ceramic Cup

Stock Code	Description
D 10N49L	Long Ceramic Cup 5/16"/8mm Bore
10N48L	Long Ceramic Cup 3/8"/10mm Bore
10N47L	Long Ceramic Cup 7/16"/11mm Bore

Stubby Series Collet

Stock Code	Description
E 10N21S	Stubby Collet .020"/0.5mm Bore
10N22S	Stubby Collet .040"/1.0mm Bore
10N23S	Stubby Collet 1/16"/1.6mm Bore
10N24S	Stubby Collet 3/32"/2.4mm Bore
10N25S	Stubby Collet 1/8"/3.2mm Bore

Stubby Collet Body

Stock Code	Description
F 17CB20	Stubby Collet Body .020"-1.8"mm/0.5mm-3.2mm Bore

Stubby Series Ceramic Cup

Stock Code	Description
G 13N08	Standard Ceramic Cup 1/4"/6mm Bore
13N09	Standard Ceramic Cup 5/16"/8mm Bore
13N10	Standard Ceramic Cup 3/8"/10mm Bore
13N11	Standard Ceramic Cup 7/16"/11mm Bore
13N12	Standard Ceramic Cup 1/2"/13mm Bore
13N13	Standard Ceramic Cup 5/8"/16mm Bore

Gas Lens Body

Stock Code	Description
H 45V24	Gas Lens Body .040"/1.0mm Bore
45V25	Gas Lens Body 1/16"/1.6mm Bore

Gas Lens Body – continued

Stock Code	Description
45V26	Gas Lens Body 3/32"/2.4mm Bore
45V27	Gas Lens Body 1/8"/3.2mm Bore
45V28	Gas Lens Body 5/32"/4.0mm Bore

Standard Gas Lens Cup

Stock Code	Description
I 54N18	Standard Gas Lens Cup 1/4"/6mm Bore
54N17	Standard Gas Lens Cup 5/16"/8mm Bore
54N16	Standard Gas Lens Cup 3/8"/10mm Bore
54N15	Standard Gas Lens Cup 7/16"/11mm Bore
54N14	Standard Gas Lens Cup 1/2"/13mm Bore
54N19	Standard Gas Lens Cup 11/16"/17mm Bore

Long Gas Lens Cup

Stock Code	Description
J 54N17L	Long Gas Lens Cup 5/16"/8mm Bore
54N16L	Long Gas Lens Cup 3/8"/10mm Bore
54N15L	Long Gas Lens Cup 7/16"/11mm Bore

Large Diameter Gas Lens Body

Stock Code	Description
K 45V116	Large Dia Gas Lens Body 1/16"/1.6mm Bore
45V64	Large Dia Gas Lens Body 3/32"/2.4mm Bore
45V63	Large Dia Gas Lens Body 5/32"/4.0mm Bore
995795	Large Dia Gas Lens Body 1/8"/3.2mm Bore

Large Diameter Gas Lens Cup

Stock Code	Description
L 57N75	Large Dia Gas Lens Cup 3/8"/10mm Bore
57N74	Large Dia Gas Lens Cup 1/2"/13mm Bore
53N88	Large Dia Gas Lens Cup 5/8"/16mm Bore
53N87	Large Dia Gas Lens Cup 3/4"/19mm Bore

Components

Stock Code	Description
1 18CG	Cup Gasket
2 18CG20	Cup Gasket for Stubby Collet Body
3 54N01	Gas Lens Insulator (use with 18CG)
4 54N63	Insulator Large Diameter Gas Lens (use with 18CG)
5 PRO17FX	Torch Head Flexible
6 PRO17	Torch Head including Cip Gasket
7 98W18	Back Cap O Ring
8 PRO57Y02	Back Cap Long
9 PRO57Y04	Back Cap Short
10 PRO1MS	Momentary Switch Kit (fitted as Standard) Alternative switch options are listed on Page 137
11 PROSWL4	Connector & Leads x 4mt/12.5ft
PROSWL8	Connector & Leads x 8mt/25ft
12 PROH100	Pro-Grip™ Tig Handle Small
13 PROSP	Screw Pack
14 PROKJ100	Knuckle Joint c/w Lock Nut
15 PROLC100-08	Leather Cover x 0.8mt/2.6ft
16 PROCO100-40	Complete Cover Assembly x 4mt/12.5ft
PROCO100-80	Complete Cover Assembly x 8mt/25ft
17 PRONC32	Neoprene Cover x 3.2mt/10.5ft
PRONC72	Neoprene Cover x 7.2mt/23.6ft
18 PROJ100	Sheath Jointing Repair Kit

NEW PRO-18 EN PRO-18FX



WATER COOLED PRO-GRIP™ TIG WELDING TORCH

Rating: 350A DC, 260A AC @ 100% Duty Cycle, EN60974-7 0.0209 to 5/329/0.5mm-4.0mm Electrodes

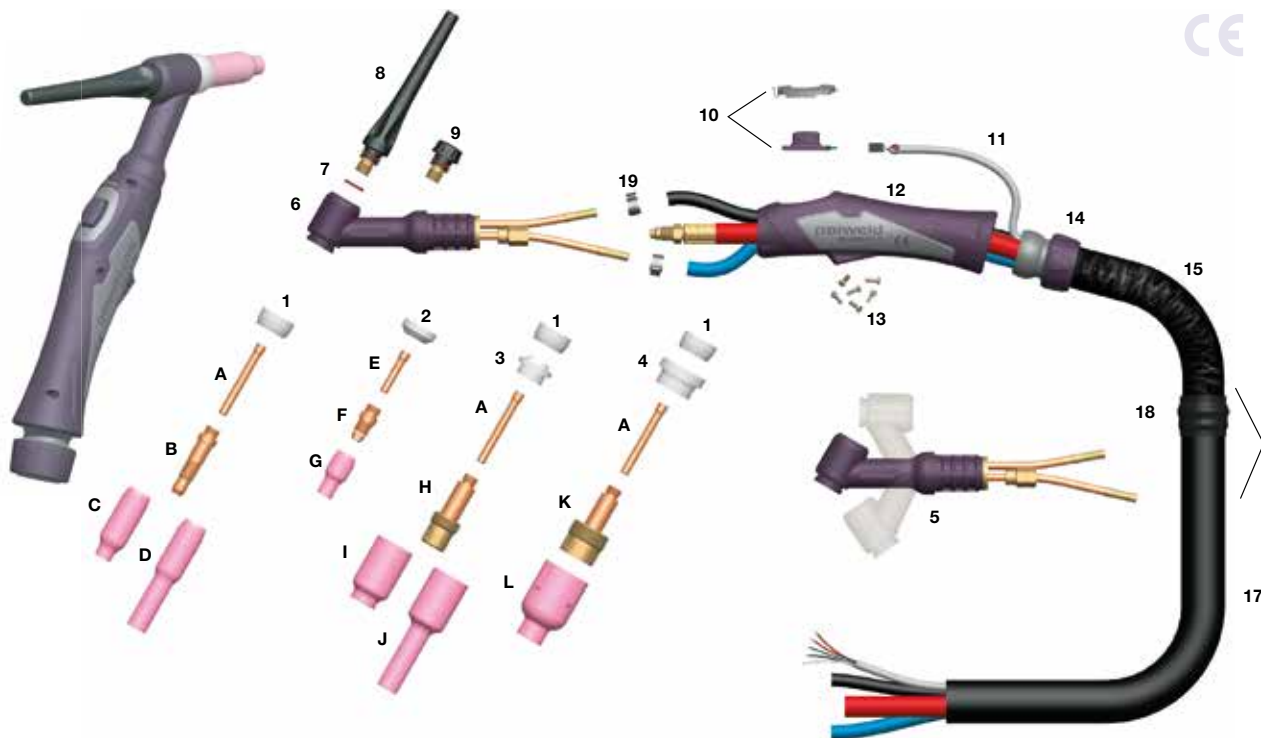

Torch Head

Stock Code	Description
PRO18	PRO18 Torch Head Water Cooled 350A DC
PRO18FX	PRO18FX Torch Head Flexible Water Cooled 350A DC

Cable Length

Stock Code	Description
12	12.5ft Cables (4m) c/w Leather Cover and Neoprene Sheath
25	25ft Cables (8m) c/w Leather Cover and Neoprene Sheath

Switch Option

Stock Code	Description
S1	Momentary Switch
S1L	Momentary Switch and Lever
S2	2 Button Momentary
S3	3 Button Momentary
S4	4 Switch Momentary Rocker Kit
1K	1 Button Momentary +1K Potentiometer
2K	1 Button Momentary +5K Potentiometer
3K	1 Button Momentary +10K Potentiometer
4K	1 Button Momentary +25K Potentiometer
N	Blank

Cable Termination

UK/European Cable Termination Stock Code	Description
BW	3/8" BSP On Water, Gas, Power
EW	Central Connector
WW	WTW Connector
LW	L-TEC Euro
DQ	35-50 Dinse on Power QF on Water, In/Out 3/8" BSP on gas

USA Cable Termination

Stock Code	Description
UW	7/8" UNF LH male on power, 5/8" UNF RH male on gas, 5/8" UNF LH male on water
UE	35-95 Dinse on power, 5/8" UNF LH on water In/Out, 5/8" UNF RH male on gas

Cable Plug

Stock Code	Description
0	2 Pin Amphenol Plug
1	4 Pin Amphenol Plug
2	5 Pin Amphenol Plug
3	6 Pin Amphenol Plug
4	14 Pin Amphenol Plug
5	6 Pin Harting Plug
6	8 Pin Thermal Arc Plug
7	3 Pin Tuchel Plug
8	9 Pin Tuchel Plug
9	5 Pin Tuchel Plug
10	12 Pin Bundy Plug
11	7 Pin Migatronc Plug
12	2 Pin XTI Inverter Plug
14	5 Pin XTI Inverter Plug

Standard Collet

Stock Code	Description
A 10N21	Standard Collet .020"/0.5mm Bore
10N22	Standard Collet .040"/1.0mm Bore
10N23	Standard Collet 1/16"/1.6mm Bore
10N23M	Standard Collet 5/64"/2.0mm Bore
10N24	Standard Collet 3/32"/2.4mm Bore
10N25	Standard Collet 1/8"/3.2mm Bore
54N20	Standard Collet 5/32"/4.0mm Bore

Standard Collet Body

Stock Code	Description
B 10N29	Standard Collet Body .020"/0.5mm Bore
10N30	Standard Collet Body .040"/1.0mm Bore
10N31	Standard Collet Body 1/16"/1.6mm Bore
10N31M	Standard Collet Body 5/64"/2.0mm Bore
10N32	Standard Collet Body 3/32"/2.4mm Bore
10N28	Standard Collet Body 1/8"/3.2mm Bore
406488	Standard Collet Body 5/32"/4.0mm Bore

Standard Ceramic Cup

Stock Code	Description
C 10N50	Standard Ceramic Cup 1/4"/6mm Bore
10N49	Standard Ceramic Cup 5/16"/8mm Bore
10N48	Standard Ceramic Cup 3/8"/10mm Bore
10N47	Standard Ceramic Cup 7/16"/11mm Bore
10N46	Standard Ceramic Cup 1/2"/13mm Bore
10N45	Standard Ceramic Cup 5/8"/16mm Bore
10N44	Standard Ceramic Cup 3/4"/19mm Bore

Long Ceramic Cup

Stock Code	Description
D 10N49L	Long Ceramic Cup 5/16"/8mm Bore
10N48L	Long Ceramic Cup 3/8"/10mm Bore
10N47L	Long Ceramic Cup 7/16"/11mm Bore

Stubby Collet

Stock Code	Description
E 10N21S	Stubby Collet .020"/0.5mm Bore
10N22S	Stubby Collet .040"/1.0mm Bore
10N23S	Stubby Collet 1/16"/1.6mm Bore
10N24S	Stubby Collet 3/32"/2.4mm Bore
10N25S	Stubby Collet 1/8"/3.2mm Bore

Stubby Collet Body

Stock Code	Description
F 17CB20	Stubby Collet Body .020"-1/8"/0.5mm-3.2mm Bore

Stubby Standard Ceramic Cup

Stock Code	Description
G 13N08	Standard Ceramic Cup 1/4"/6mm Bore
13N09	Standard Ceramic Cup 5/16"/8mm Bore
13N10	Standard Ceramic Cup 3/8"/10mm Bore
13N11	Standard Ceramic Cup 7/16"/11mm Bore
13N12	Standard Ceramic Cup 1/2"/13mm Bore
13N13	Standard Ceramic Cup 5/8"/16mm Bore

Gas Lens Body

Stock Code	Description
H 45V24	Gas Lens Body .040"/1.0mm Bore
45V25	Gas Lens Body 1/16"/1.6mm Bore

Gas Lens Body – continued

Stock Code	Description
45V26	Gas Lens Body 3/32"/2.4mm Bore
45V27	Gas Lens Body 1/8"/3.2mm Bore
45V28	Gas Lens Body 5/32"/4.0mm Bore

Standard Gas Lens Cup

Stock Code	Description
I 54N18	Standard Gas Lens Cup 1/4"/6mm Bore
54N17	Standard Gas Lens Cup 5/16"/8mm Bore
54N16	Standard Gas Lens Cup 3/8"/10mm Bore
54N15	Standard Gas Lens Cup 7/16"/11mm Bore
54N14	Standard Gas Lens Cup 1/2"/13mm Bore
54N19	Standard Gas Lens Cup 1/16"/17mm Bore

Long Gas Lens Cup

Stock Code	Description
J 54N17L	Long Gas Lens Cup 5/16"/8mm Bore
54N16L	Long Gas Lens Cup 3/8"/10mm Bore
54N15L	Long Gas Lens Cup 7/16"/11mm Bore

Large Diameter Gas Lens Body

Stock Code	Description
K 45V116	Large Dia Gas Lens Bdy 1/16"/1.6mm Bore
45V64	Large Dia Gas Lens Body 3/32"/2.4mm Bore
995795	Large Dia Gas Lens Body 1/8"/3.2mm Bore

Large Diameter Gas Lens Cup

Stock Code	Description
L 57N75	Large Dia Gas Lens Cup 3/8"/10mm Bore
57N74	Large Dia Gas Lens Cup 1/2"/13mm Bore
53N88	Large Dia Gas Lens Cup 5/8"/16mm Bore
53N87	Large Dia Gas Lens Cup 3/4"/19mm Bore

Components

Stock Code	Description
1 18CG	Cup Gasket
2 18CG20	Cup Gasket for Stubby Collet Body
3 54N01	Gas Lens Insulator (use with 18CG)
4 54N63	Insulator Large Diameter Gas Lens (use with 18CG)
5 PRO18FX	Torch Head Flexible
6 PRO18	Torch Head including Cup Gasket
7 98W18	Back Cap O Ring
8 PRO57Y02	Back Cap Long
9 PRO57Y04	Back Cap Short
10 PRO1MS	Momentary Switch Kit (fitted as Standard) Alternative switch options are listed on Page 137
11 PROSWL4	Connector Leads x 4mt/12.5ft
PROSWL8	Connector Leads x 8mt/25ft
12 PROH200	Pro-Grip™ Tig Handle Large
13 PROSP	Screw Pack
14 PROKJ200	Knuckle Joint c/w Lock Nut
15 PROLC200-08	Leather Cover x 0.8mt/2.6ft
16 PROCO200-40	Complete Cover Assembly x 4mt/12.5ft
PROCO200-80	Complete Cover Assembly x 8mt/25ft
17 PRONC-32	Neoprene Cover x 3.2mt/10.5ft
PRONC-72	Neoprene Cover x 7.2mt/23.6ft
18 PROJK200	Sheath Jointing Repair Kit
19 B5024	Hose Clamp 9.5mm

NEW PRO-18SC



WATER COOLED PRO-GRIP™ TIG WELDING TORCH

Rating: 400A DC, 300A AC @ 100% Duty Cycle, EN60974-7 .0209 to 3/169/0.5mm-4.8mm Electrodes

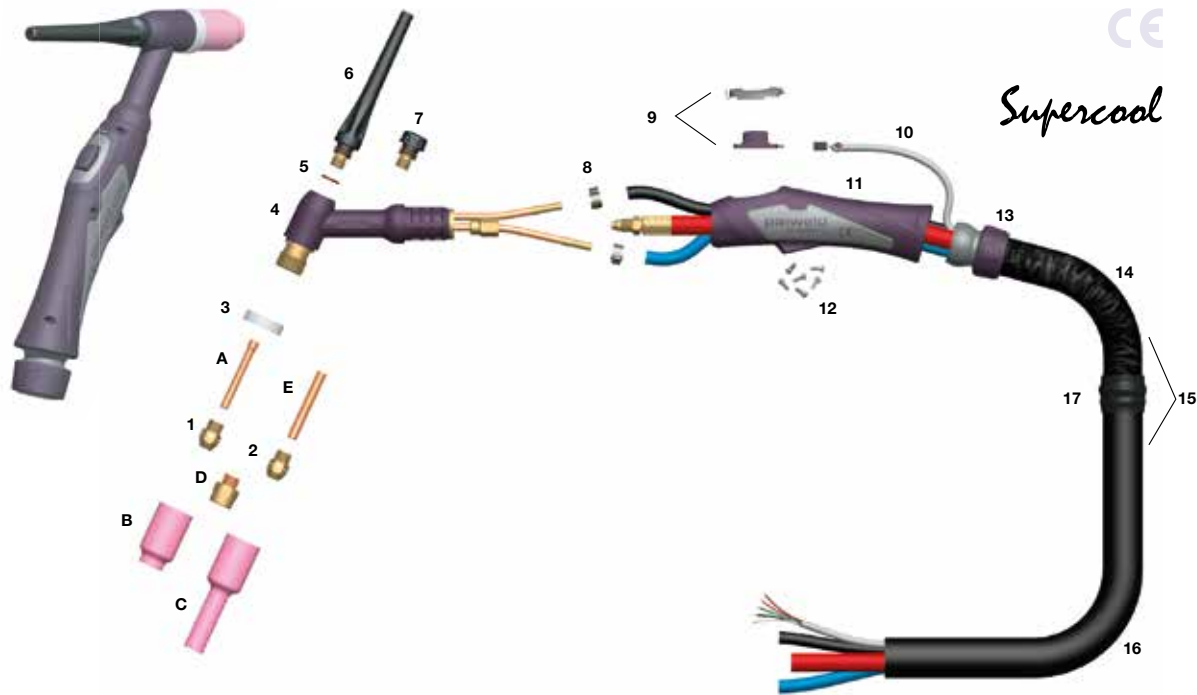

Torch Head

Stock Code Description

PRO18SC Torch Head Water Cooled 400A DC

Cable Length

Stock Code Description

12 12.5ft Cables (4m) c/w Leather Cover and Neoprene Sheath
 25 25ft Cables (8m) c/w Leather Cover and Neoprene Sheath

Switch Option

Stock Code Description

S1 Momentary Switch
 S1L Momentary Switch and Lever
 S2 2 Button Momentary
 S3 3 Button Momentary
 S4 4 Switch Momentary Rocker Kit
 1K 1 Button Momentary +1K Potentiometer
 2K 1 Button Momentary +5K Potentiometer
 3K 1 Button Momentary +10K Potentiometer
 4K 1 Button Momentary +25K Potentiometer
 N Blank

Cable Termination

UK/European Cable Termination

Stock Code Description

BW 3/8" BSP On Water, Gas, Power
 DQ 35-95 Dinse, Quick fit Water In/Out, 3/8" BSP Gas
 EW Central Connector,
 WW WTW Connector
 LW L-TEC Euro

USA Cable Termination

Stock Code Description

UW 7/8" UNF LH male on power, 5/8" UNF RH male on gas, 5/8" UNF LH male on water
 UE 35-95 Dinse on power, 5/8" UNF LH on water In/Out, 5/8" UNF RH male on gas

Cable Plug

Stock Code Description

0 2 Pin Amphenol Plug
 1 4 Pin Amphenol Plug
 2 5 Pin Amphenol Plug
 3 6 Pin Amphenol Plug
 4 14 Pin Amphenol Plug
 5 6 Pin Harting Plug
 6 8 Pin Thermal Arc Plug
 7 3 Pin Tuchel Plug
 8 9 Pin Tuchel Plug
 9 5 Pin Tuchel Plug
 10 12 Pin Bundy Plug
 11 7 Pin Migatronic Plug
 12 2 Pin XTI Inverter Plug
 14 5 Pin XTI Inverter Plug

Standard Collet

Stock Code	Description
A 10N21	Standard Collet .020"/0.5mm Bore
10N22	Standard Collet .040"/1.0mm Bore
10N23	Standard Collet 1/16"/1.6mm Bore
10N24	Standard Collet 3/32"/2.4mm Bore
10N25	Standard Collet 1/8"/3.2mm Bore
54N20	Standard Collet 5/32"/4.0mm Bore

Standard Gas Lens Cup

Stock Code	Description
B 54N18	Standard Gas Lens Cup 1/4"/6mm Bore
54N17	Standard Gas Lens Cup 5/16"/8mm Bore
54N16	Standard Gas Lens Cup 3/8"/10mm Bore
54N15	Standard Gas Lens Cup 7/16"/11mm Bore
54N14	Standard Gas Lens Cup 1/2"/13mm Bore
54N19	Standard Gas Lens Cup 1/16"/17mm Bore

Long Gas Lens Cup

Stock Code	Description
C 54N17L	Long Gas Lens Cup 5/16"/8mm Bore
54N16L	Long Gas Lens Cup 3/8"/10mm Bore
54N15L	Long Gas Lens Cup 7/16"/11mm Bore

Gas Lens Body

Stock Code	Description
D 18GL16	Gas Lens Body 1/16"/1.6mm Bore
18GL32	Gas Lens Body 3/32"/2.4mm Bore
18GL18	Gas Lens Body 1/8"/3.2mm Bore
18GL53	Gas Lens Body 5/32"/4.0mm Bore
18GL36	Gas Lens Body 3/16"/4.8mm Bore

Heavy Duty Collet

Stock Code	Description
E 10N25HD	Heavy Duty Collet 1/8"/3.2mm Bore
54N20HD	Heavy Duty Collet 5/32"/4.0mm Bore
18C36	Heavy Duty Collet 3/16"/4.8mm Bore

Components

Stock Code	Description
1 NCB-53	Standard Nose Collet Body
2 NCB-36	Heavy Duty Nose Collet Body
3 18NG	Nozzle Gasket
4 PRO18SC	Torch Head including Nozzle Gasket
5 98W18	Back Cap O Ring
6 PRO57Y02	Back Cap Long
7 PRO57Y04	Back Cap Short
8 B5024	Hose Clamp 9.5mm
9 PRO1MS	Momentary Switch Kit (fitted as Standard) Alternative switch options are listed on Page 137
10 PROSWL4	Connector Leads x 4mt/12.5ft
PROSWL8	Connector Leads x 8mt/25ft
11 PROH200	Pro-Grip™ Tig Handle Large
12 PROSP	Screw Pack
13 PROKJ200	Knuckle Joint c/w Lock Nut
14 PROLC200-08	Leather Cover x 0.8mt/2.6ft
15 PROCO200-40	Complete Cover Assembly x 4mt/12.5ft
PROCO200-80	Complete Cover Assembly x 8mt/25ft
16 PRONCL-32	Neoprene Cover x 3.2mt/10.5ft
PRONCL-72	Neoprene Cover x 7.2mt/23.6ft
17 PROJ200	Sheath Jointing Repair Kit

NEW PRO-20 EN PRO-20FXL



WATER COOLED PRO-GRIP™ TIG WELDING TORCH

Rating: 250A DC, 190A AC @ 100% Duty Cycle, EN60974-7 .020 to 1/8 /0.5mm-3.2mm Electrodes

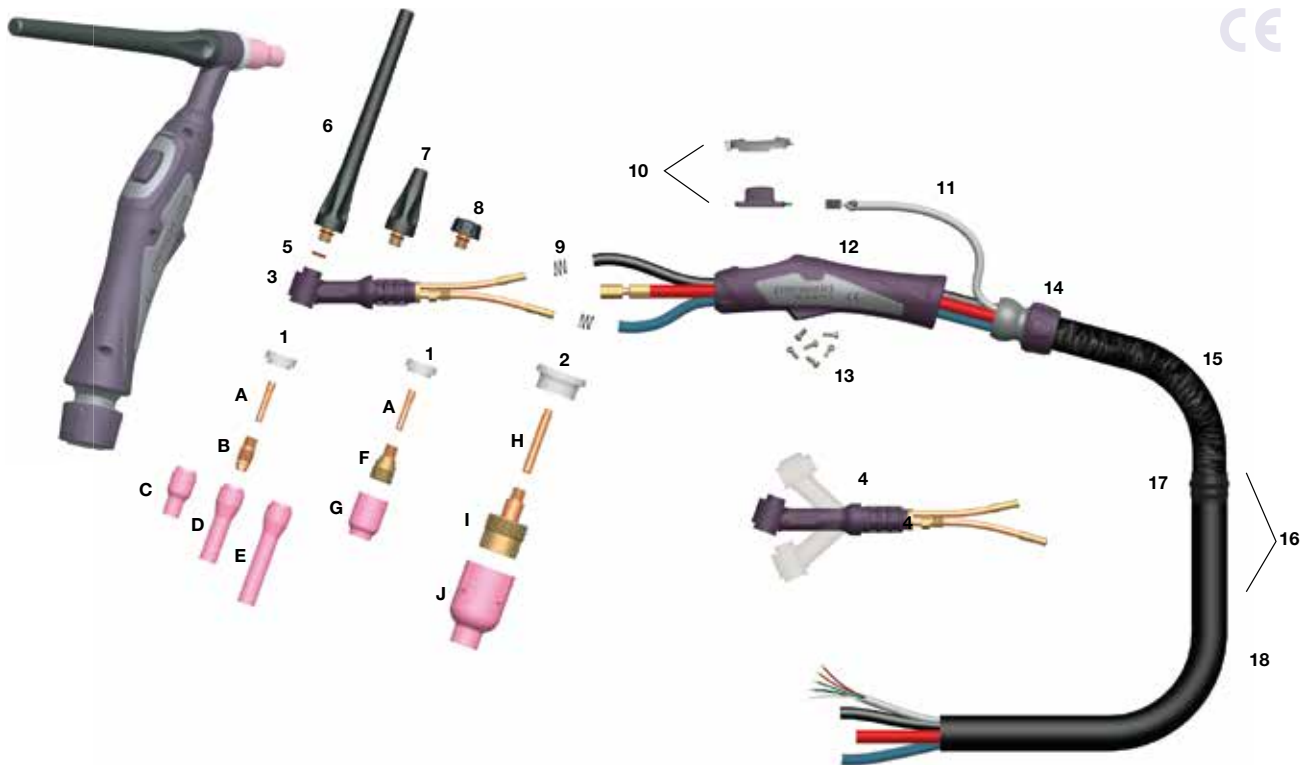

Torch Head

Stock Code Description

PRO20	Torch Head Water Cooled 250A DC
PRO20FXL	Torch Head Flexible Water Cooled 250A DC

Cable Length

Stock Code Description

12	12.5ft Cables (4m) c/w Leather Cover and Neoprene Sheath
25	25ft Cables (8m) c/w Leather Cover and Neoprene Sheath

Switch Option

Stock Code Description

S1	Momentary Switch
S1L	Momentary Switch and Lever
S2	2 Button Momentary
S3	3 Button Momentary
S4	4 Switch Momentary Rocker Kit
1K	1 Button Momentary +1K Potentiometer
2K	1 Button Momentary +5K Potentiometer
3K	1 Button Momentary +10K Potentiometer
4K	1 Button Momentary +25K Potentiometer
N	Blank

Cable Termination

UK/European Cable Termination

Stock Code Description

BW	3/8" BSP On Water, Gas, Power
DQ	35-95 Dinse, Quick fit Water In/Out, 3/8" BSP Gas
EW	Central Connector
WW	WTW Connector
LW	L-TEC Euro

USA Cable Termination

Stock Code Description

UW	7/8" UNF LH male on power, 5/8" UNF RH male on gas, 5/8" UNF LH male on water
UE	35-95 Dinse on power, 5/8" UNF LH on water In/Out, 5/8" UNF RH male on gas

Cable Plug

Stock Code Description

0	2 Pin Amphenol Plug
1	4 Pin Amphenol Plug
2	5 Pin Amphenol Plug
3	6 Pin Amphenol Plug
4	14 Pin Amphenol Plug
5	6 Pin Harting Plug
6	8 Pin Thermal Arc Plug
7	3 Pin Tuchel Plug
8	9 Pin Tuchel Plug
9	5 Pin Tuchel Plug
10	12 Pin Bundy Plug
11	7 Pin Migatronik Plug
12	2 Pin XTI Inverter Plug
14	5 Pin XTI Inverter Plug

Standard Collet

	Stock Code	Description
A	13N20	Standard Collet .020"/0.5mm Bore
	13N21	Standard Collet .040"/1.0mm Bore
	13N22	Standard Collet 1/16"/1.6mm Bore
	13N22M	Standard Collet 5/64"/2.0mm Bore
	13N23	Standard Collet 3/32"/2.4mm Bore
	13N24	Standard Collet 1/8"/3.2mm Bore

Standard Collet Body

	Stock Code	Description
B	13N25	Standard Collet Body .020"/0.5mm Bore
	13N26	Standard Collet Body .040"/1.0mm Bore
	13N27	Standard Collet Body 1/16"/1.6mm Bore
	13N27M	Standard Collet Body 5/64"/2.0mm Bore
	13N28	Standard Collet Body 3/32"/2.4mm Bore
	13N29	Standard Collet Body 1/8"/3.2mm Bore

Standard Ceramic Cup

	Stock Code	Description
C	13N08	Standard Ceramic Cup 1/4"/6mm Bore
	13N09	Standard Ceramic Cup 5/16"/8mm Bore
	13N10	Standard Ceramic Cup 3/8"/10mm Bore
	13N11	Standard Ceramic Cup 7/16"/11mm Bore
	13N12	Standard Ceramic Cup 1/2"/13mm Bore
	13N13	Standard Ceramic Cup 5/8"/16mm Bore

Long Ceramic Cup

	Stock Code	Description
D	796F70	Long Ceramic Cup 3/16"/5mm Bore
	796F71	Long Ceramic Cup 1/4"/6mm Bore
	796F72	Long Ceramic Cup 5/16"/8mm Bore
	796F73	Long Ceramic Cup 3/8"/10mm Bore

Extra Long Ceramic Cup

	Stock Code	Description
E	796F74	Extra Long Ceramic Cup 3/16"/5mm Bore
	796F75	Extra Long Ceramic Cup 1/4"/6mm Bore
	796F76	Extra Long Ceramic Cup 5/16"/8mm Bore
	796F77	Extra Long Ceramic Cup 3/8"/10mm Bore

Gas Lens Body

	Stock Code	Description
F	45V41	Gas Lens Body .020"/0.5mm Bore
	45V42	Gas Lens Body .040"/1.0mm Bore
	45V43	Gas Lens Body 1/16"/1.6mm Bore
	45V44	Gas Lens Body 3/32"/2.4mm Bore
	45V45	Gas Lens Body 1/8"/3.2mm Bore

Gas Lens Cup

	Stock Code	Description
G	53N58	Standard Gas Lens Cup 1/4"/6mm Bore
	53N59	Standard Gas Lens Cup 5/16"/8mm Bore
	53N60	Standard Gas Lens Cup 3/8"/10mm Bore
	53N61	Standard Gas Lens Cup 7/16"/11mm Bore
	53N61-S	Standard Gas Lens Cup 1/2"/13 mm Bore

Large Diameter Gas Lens Collet

	Stock Code	Description
H	13N22L	Large Diameter Gas Lens Collet 1/16"/1.6mm Bore
	13N23L	Large Diameter Gas Lens Collet 3/32"/2.4mm Bore

Large Diameter Gas Lens Body

	Stock Code	Description
I	45V116S	Large Diameter Gas Lens Body 1/16"/1.6mm Bore
	45V64S	Large Diameter Gas Lens Body 3/32"/2.4mm Bore

Large Diameter Gas Lens Cup

	Stock Code	Description
J	57N75	Large Diameter Gas Lens Cup 3/8"/10mm Bore
	57N74	Large Diameter Gas Lens Cup 1/2"/11mm Bore
	53N88	Large Diameter Gas Lens Cup 5/8"/16mm Bore
	53N87	Large Diameter Gas Lens Cup 3/4"/19mm Bore

Components

	Stock Code	Description
1	598882	Cup Gasket
2	54N63-20	Insulator Large Diameter Gas Lens
3	PRO20	Torch Head including Cup Gasket
4	PRO20FXL	Torch Head Flexible
5	98W77	Back Cap O Ring
6	PRO41V24	Pro-Grip™ Tig Back Cap Long
7	PRO41V35	Pro-Grip™ Tig Back Cap Medium
8	PRO41V33	Pro-Grip™ Tig Back Cap Small
9	53N04	Wire Clamps
10	PRO1MS	Momentary Switch Kit (fitted as Standard) Alternative switch options are listed on Page 137
11	PROSWL4	Connector Leads x 4mt/12.5ft
	PROSWL8	Connector Leads x 8mt/25ft
12	PROH100	Pro-Grip™ Tig Handle Small
13	PROSP	Screw Pack
14	PROKJ100	Knuckle Joint c/w Lock Nut
15	PROLC100-08	Leather Cover x 0.8mt/2.6ft
16	PROCO100-40	Complete Cover Assembly 4mt/12.5ft
	PROCO100-80	Complete Cover Assembly x 8mt/25ft
17	PROJK100	Jointing Repair Kit
18	PRONC-32	Neoprene Cover x 3.2mt/10.5ft
	PRONC-72	Neoprene Cover x 7.2mt/23.6ft

NEW PRO-26 EN PRO-26FXL



WATER COOLED PRO-GRIP™ TIG WELDING TORCH

Rating: 200A DC, 150A AC @ 60% Duty Cycle, EN60974-7 .0209 to 5/329/0.5mm-4.0mm Electrodes

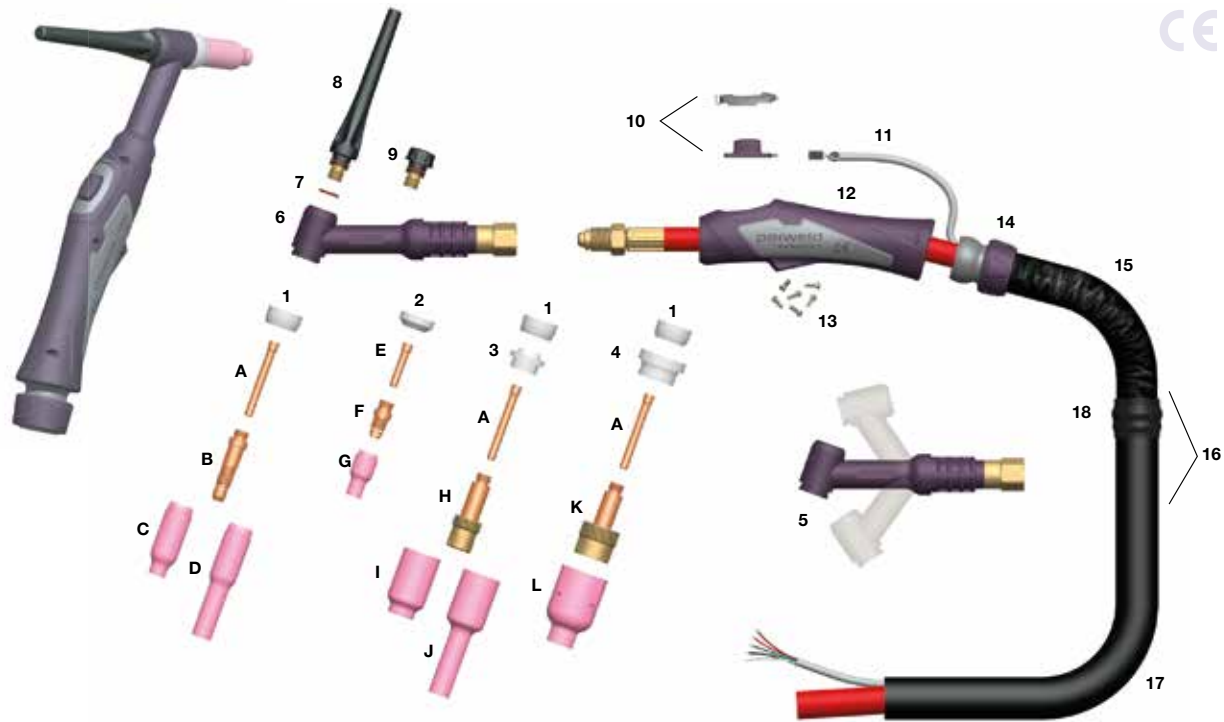

Torch Head

Stock Code	Description
------------	-------------

PRO26	Torch Head Air Cooled 200A DC
PRO26FX	Torch Head Flexible Air Cooled 200A DC

Cable Length

Stock Code	Description
------------	-------------

12	12.5ft cables (4m) c/wLeather Cover and Neoprene Sheath
25	25ft cables (8m) c/w Leather Cover and Neoprene Sheath

Switch Option

Stock Code	Description
------------	-------------

S1	Momentary Switch
S1L	Momentary Switch and Lever
S2	2 Button Momentary
S3	3 Button Momentary
S4	4 Switch Momentary Rocker Kit
1K	1 Button Momentary +1K Potentiometer
2K	1 Button Momentary +5K Potentiometer
3K	1 Button Momentary +10K Potentiometer
4K	1 Button Momentary +25K Potentiometer
N	Blank

Cable Termination

UK/European Cable Termination	
Stock Code	Description

BG	Single 3/8" BSP Connection
EG	Central Connector
WG	WTG Connector
LG	L-TEC Euro
BD	35-50 Dinse on Power 3/8" BSP on gas

USA Cable Termination	
Stock Code	Description

US	Lug on power, 5/8" UNF RH Male on Gas
UN	Single 5/8" UNF RH male
UD	35-95 dinse on power, 5/8" UNF RH Male on Gas

Cable Plug

Stock Code	Description
------------	-------------

0	2 Pin Amphenol Plug
1	4 Pin Amphenol Plug
2	5 Pin Amphenol Plug
3	6 Pin Amphenol Plug
4	14 Pin Amphenol Plug
5	6 Pin Harting Plug
6	8 Pin Thermal Arc Plug
7	3 Pin Tuchel Plug
8	9 Pin Tuchel Plug
9	5 Pin Tuchel Plug
10	12 Pin Bundy Plug
11	7 Pin Migatronic Plug
12	2 Pin XTI Inverter Plug
14	5 Pin XTI Inverter Plug

Standard Collet

Stock Code	Description
A 10N21	Standard Collet .020"/0.5mm Bore
10N22	Standard Collet .040"/1.0mm Bore
10N23	Standard Collet 1/16"/1.6mm Bore
10N24	Standard Collet 3/32"/2.4mm Bore
10N25	Standard Collet 1/8"/3.2mm Bore
54N20	Standard Collet 5/32"/4.0mm Bore

Standard Collet Body

Stock Code	Description
B 10N29	Standard Collet Body .020"/0.5mm Bore
10N30	Standard Collet Body .040"/1.0mm Bore
10N31	Standard Collet Body 1/16"/1.6mm Bore
10N32	Standard Collet Body 3/32"/2.4mm Bore
10N28	Standard Collet Body 1/8"/3.2mm Bore
406488	Standard Collet Body 5/32"/4.0mm Bore

Standard Ceramic Cup

Stock Code	Description
C 10N50	Standard Ceramic Cup 1/4"/6mm Bore
10N49	Standard Ceramic Cup 5/16"/8mm Bore
10N48	Standard Ceramic Cup 3/8"/10mm Bore
10N47	Standard Ceramic Cup 7/16"/11mm Bore
10N46	Standard Ceramic Cup 1/2"/13mm Bore
10N45	Standard Ceramic Cup 5/8"/16mm Bore
10N44	Standard Ceramic Cup 3/4"/19mm Bore

Standard Long Ceramic Cup

Stock Code	Description
D 10N49L	Long Ceramic Cup 5/16"/8mm Bore
10N48L	Long Ceramic Cup 3/8"/10mm Bore
10N47L	Long Ceramic Cup 7/16"/11mm Bore

Stubby Series Collet

Stock Code	Description
E 10N21S	Stubby Collet .020"/0.5mm Bore
10N22S	Stubby Collet .040"/1.0mm Bore
10N23S	Stubby Collet 1/16"/1.6mm Bore
10N24S	Stubby Collet 3/32"/2.4mm Bore
10N25S	Stubby Collet 1/8"/3.2mm Bore

Stubby Collet Body

Stock Code	Description
F 17CB20	Stubby Collet Body .020"-1/8"/0.5mm-3.2mm Bore

Stubby Standard Ceramic Cup

Stock Code	Description
G 13N08	Standard Ceramic Cup 1/4"/6mm Bore
13N09	Standard Ceramic Cup 5/16"/8mm Bore
13N10	Standard Ceramic Cup 3/8"/10mm Bore
13N11	Standard Ceramic Cup 7/16"/11mm Bore
13N12	Standard Ceramic Cup 1/2"/13mm Bore
13N13	Standard Ceramic Cup 5/8"/16mm Bore

Gas Lens Body

Stock Code	Description
H 45V29	Gas Lens Body .020"/0.5mm Bore
45V24	Gas Lens Body .040"/1.0mm Bore
45V25	Gas Lens Body 1/16"/1.6mm Bore
45V26	Gas Lens Body 3/32"/2.4mm Bore
45V27	Gas Lens Body 1/8"/3.2mm Bore

Standard Gas Lens Cup

Stock Code	Description
I 54N18	Standard Gas Lens Cup 1/4"/6mm Bore
54N17	Standard Gas Lens Cup 5/16"/8mm Bore
54N16	Standard Gas Lens Cup 3/8"/10mm Bore
54N15	Standard Gas Lens Cup 7/16"/11mm Bore
54N14	Standard Gas Lens Cup 1/2"/13mm Bore
54N19	Standard Gas Lens Cup 11/16"/17mm Bore

Long Gas Lens Cup

Stock Code	Description
J 54N17L	Long Gas Lens Cup 5/16"/8mm Bore
54N16L	Long Gas Lens Cup 3/8"/10mm Bore
54N15L	Long Gas Lens Cup 7/16"/11mm Bore

Large Diameter Gas Lens Body

Stock Code	Description
K 45V116	Large Dia Gas Lens Body 1/16"/1.6mm Bore
45V64	Large Dia Gas Lens Body 3/32"/2.4mm Bore
995795	Large Dia Gas Lens Body 1/8"/3.2mm Bore

Large Diameter Gas Lens Cup

Stock Code	Description
L 57N75	Large Diameter Gas Lens Cup 3/8"/10mm Bore
57N74	Large Diameter Gas Lens Cup 1/2"/15mm Bore
53N88	Large Diameter Gas Lens Cup 5/8"/16mm Bore
53N87	Large Diameter Gas Lens Cup 3/4"/19mm Bore

Components

Stock Code	Description
1 18CG	Cup Gasket
2 18CG20	Cup Gasket for Stubby Collet Body
3 54N01	Gas Lens Insulator (use with 18CG)
4 54N63	Insulator Large Diameter Gas Lens (use with 18CG)
5 PRO26FX	Torch Head Flexible
6 PRO26	Torch Head including Cup Gasket
7 98W18	Back Cap O Ring
8 PRO57Y02	Back Cap Long
9 PRO57Y04	Back Cap Short
10 PRO1MS	Momentary Switch Kit (fitted as Standard) Alternative switch options are listed on Page 137
11 PROSWL4	Connector + Leads x 4mt/12.5ft
PROSWL8	Connector + Leads x 8mt/25ft
12 PROH200	Pro-Grip™ Tig Handle Large
13 PROSP	Screw Pack
14 PROKJ200	Knuckle Joint c/w Lock Nut
15 PROLC200-08	Leather Cover x 0.8mt/2.6ft
16 PROCO200-40	Complete Cover Assembly x 4mt/12.5ft
PROCO200-80	Complete Cover Assembly x 8mt/25ft
17 PRONCL-32	Neoprene Cover x 3.2mt/10.5ft
PRONCL-72	Neoprene Cover x 7.2mt/23.6ft
18 PROJ200	Sheath Jointing Repair Kit

HOE BESTEL JE UW PRO-GRIP™ TIG TOORTS



Ordering Information

Due to the extensive range of options please choose from the following when ordering your Parweld Pro-Grip™ Tig Torch;

1. Select the model of torch head
2. Select the length of cable required
3. Select the switch required
4. Select the correct cable termination required
5. Add a Cable Plug if required

Example:- PRO18FX-25S1BW2

PRO18FX Pro-Grip Torch x 25ft with momentary switch, 3/8 BSP fittings and 5 pin Amphenol Plug.

1. Torch Head

Stock Code	Description
PRO9	Torch Head Air Cooled 125A DC
PRO9FXL	Torch Head Flexible Air Cooled 125A DC
PRO17	Torch Head Air Cooled 150A DC
PRO17FX	Torch Head Flexible Air Cooled 150A DC
PRO18	Torch Head Water Cooled 350A DC
PRO18FX	Torch Head Flexible Water Cooled 350A DC
PRO18SC	Torch Head Water Cooled 400A DC
PRO20	Torch Head Water Cooled 250A DC
PRO20FXL	Torch Head Flexible Water Cooled 250A DC
PRO26	Torch Head Air Cooled 200A DC
PRO26FX	Torch Head Flexible Air Cooled 200A DC

2. Cable Length

Stock Code	Description
12	12.5ft Cables (4m) c/w Leather Cover and Neoprene Sheath
25	25ft Cables (8m) c/w Leather Cover and Neoprene Sheath

3. Switch Option

Stock Code	Description
S1	Momentary Switch
S1L	Momentary Switch & Lever
S2	2 Button Momentary
S3	3 Button Momentary
S4	4 Button Rocker Momentary
1K	1 Button Momentary +1K Potentiometer
2K	1 Button Momentary +5K Potentiometer
3K	1 Button Momentary +10K Potentiometer
4K	1 Button Momentary +25K Potentiometer
N	Blank

4. Cable Termination

UK/European Cable Termination - Air Cooled

Stock Code	Description
BG	Single 3/8" BSP Connection
EG	Central Connector
WG	WTG Connector
LG	L-TEC Euro
BD	35-50 Dinse on Power 3/8" BSP on Gas
MG	Migatronicon Connections
LNG	Lincoln Invertec Connections
EMG	EWM Connections
KG	Kemppi Connection
TG	Dinse through Gas Connector 35-50mm
SG	SAF through Gas Connector 35-50mm
LRG	Lorch Connections
FRG	Fronius Connections
ESG	Esab OKC Connections
MPG	Multiprocess Euro Connector

UK/European Cable Termination - Water Cooled

Stock Code	Description
BW	3/8" BSP On Water, Gas, Power
EW	Central Connector
DQ	35-50 Dinse on Power QF on Water In/Out, 3/8BSP on Gas
WW	WTW Connector
LW	L-TEC Euro
MW	Migatronicon Connections
LNW	Lincoln Invertec Connections
EMW	EWM Connections
KW	Kemppi Connections
TW	Dinse through Gas Connector
THW	Thermal Arc Connections
LRW	Lorch Connections
FRW	Fronius Connections
ESW	Esab OKC Connections

4. Cable Termination

USA Cable Termination - Air Cooled

Stock Code	Description
US	Lug on power, 5/8" UNF RH male on gas
UN	Single 5/8" UNF RH male
A	3/8" UNF RH male (PRO9,17) 7/8" UNF RH male (PRO26)
UD	35-95 Dinse on power, 5/8" UNF RH male on gas

USA Cable Termination - Water Cooled

Stock Code	Description
UW	7/8" UNF LH male on power, 5/8" UNF RH male on gas, 5/8" UNF LH male on water.
UE	35-95 Dinse on power, 5/8" UNF LH on water In/Out, 5/8" UNF RH male on gas

5. Cable Plug

Stock Code	Description
0	2 Pin Amphenol Plug
1	4 Pin Amphenol Plug
2	5 Pin Amphenol Plug
3	6 Pin Amphenol Plug
4	14 Pin Amphenol Plug
5	6 Pin Harting Plug
6	8 Pin Thermal Arc Plug
7	3 Pin Tuchel Plug
8	9 Pin Tuchel Plug
9	5 Pin Tuchel Plug
10	12 Pin Bundy Plug
11	7 Pin Migatronic Plug
12	2 Pin XTI-180 Inverter Plug
14	5 Pin XTI-200 Inverter Plug
16	5 Pin Amphenol Plug Lincoln
18	14 Pin Parweld XTI 201, 303 Plug
19	5 Pin Parweld XTI181 Plug
20	3 Pin Parweld XTI601MP Plug
21	2 Pin ESAB Push In Plug



TORCH HEADS



AIR COOLED TORCH HEADS

Parweld Pro-Grip™ Tig Torch Heads are 100% Weldcraft OEM interchangeable. High temperature resistant silicone rubber provides a lightweight and durable outer cover, which combined with all copper components ensures cooler running temperatures and maximum current capacity. Flexible models PRO9FXL and PRO20FXL have been increased in length to provide greater access in difficult to reach areas. Coil construction has been improved to increase bend radius and coil life expectancy.

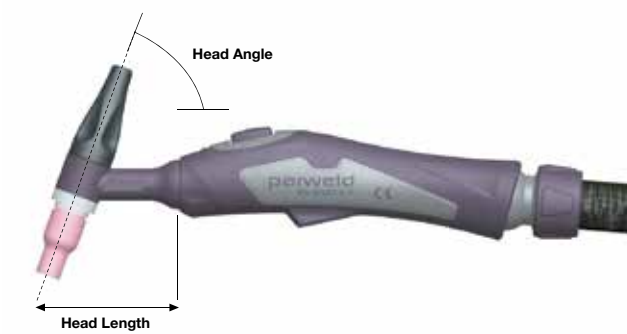

PRO9 and PRO9FXL

Rating: 125A DC, 100A AC .020" to 3/32" (0.5mm-2.4mm) electrode.

Parts are interchangeable with the PRO20, PRO20FXL models.

Technical Specification

Weight (Head Only)	3oz	85g
Torch Head Length – PRO9	2"	53mm
Torch Head Length – PRO9FXL	3.5"	91mm
Head Thread Size – PRO9/9FXL	5/16" UNF	



PRO9



PRO9FXL

PRO17 and PRO17FX

Rating: 150A DC, 115A AC .020" to 3/32" (0.5mm-2.4mm) electrode.

Parts interchange with PRO18, PRO18FX, PRO26 and PRO26FX

Technical Specification

Weight (Head Only)	6oz	170g
Torch Head Length – PRO17	3"	76mm
Torch Head Length – PRO17FX	3 3/4"	97mm
Head Thread Size – PRO17/17FX	3/8"-32 UNEF	



PRO17



PRO17FX

PRO26 and PRO26FX

Rating: 200A DC, 150A AC .020" to 1/8" (0.5mm-3.2mm) electrode.

Parts interchange with PRO18, PRO18FX, PRO17 and PRO17FX models.

Technical Specification

Weight (Head Only)	10oz	283g
Torch Head Length – PRO26	2 3/4"	71mm
Torch Head Length – PRO26FX	2 3/4"	71mm
Head Thread Size – PRO26/26FX	3/8"-32 UNEF	



PRO26



PRO26FX

TORCH HEADS



WATER COOLED TORCH HEADS

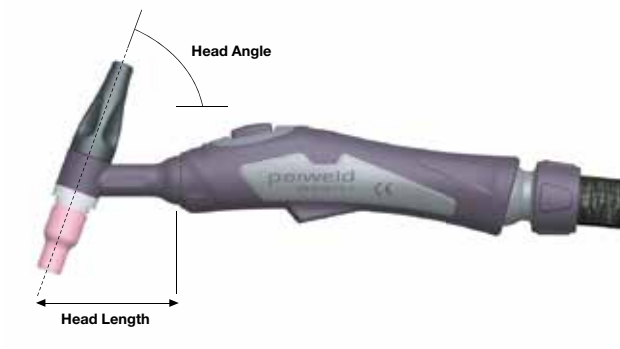

PRO20 and PRO20FXL

Rating: 250A DC, 190A AC .020" to 1/8" (0.5mm-3.2mm) electrode.
 Parts interchangeable with PRO9, PRO9FXL.

Technical Specification

Weight (Head Only)	3 oz	85gm
Torch Head Length – PRO20	2 1/4"	56mm
Torch Head Length – PRO20FXL	2 3/4"	64mm
Head Thread Size – PRO20/20FXL	5/16" UNF	

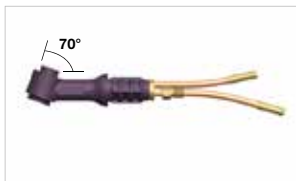

PRO20



PRO20FXL

PRO18 and PRO18FX

Rating: 350A DC, 260A AC .020" to 5/32" (0.5mm-4.0mm) electrode.
 Parts interchangeable with PRO17, PRO17FX, PRO26 and

Technical Specification

Weight (Head Only)	7 oz	200gm
Torch Head Length – PRO18	2 1/2"	64mm
Torch Head Length – PRO18FX	2 1/2"	64mm
Head Thread Size – PRO18/18FX	3/8"-32 UNEF	

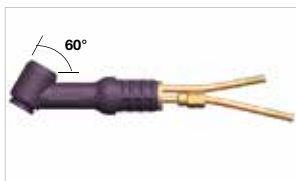

PRO18



PRO18FX

PRO18SC

Rating: 400A DC, 300A AC .020" to 3/16" (0.5mm-5.00mm) electrode.

Technical Specification

Weight (Head Only)	8 oz	226gm
Torch Head Length – PRO18SC	2 3/4"	71mm
Head Thread Size – PRO18SC	3/8"-32 UNEF	



PRO18SC

PRO-GRIP™ SWITCH CONFIGURATOR



Two sizes of ergonomic handles are utilised for the entire range. Features include soft grips, knuckle joints and ‘plug and play’ switch interchangeability.

A standard common 5 port female socket is attached to a multi core shielded switch cable into which any number of switch options can be simply and rapidly interchanged.

Torch packages are supplied with a momentary switch as standard. Alternative switches must be specified at time of ordering.

Replacement switch kits include complete switch assembly and switch housing.



Stock Code	Description
PRO1MS	Momentary Kit (fitted as standard)



Stock Code	Description
PRO2MS	2 Button Momentary Kit



Stock Code	Description
PRO3MS	3 Button Momentary Kit



Stock Code	Description
PRO4MS	4 Switch Momentary Rocker Kit



Stock Code	Description
PRO1MS-1	1 Button Momentary Kit+ 1K Potentiometer
PRO1MS-5	1 Button Momentary Kit+ 5K Potentiometer
PRO1MS-10	1 Button Momentary Kit+ 10K Potentiometer
PRO1MS-25	1 Button Momentary Kit+ 25K Potentiometer



Stock Code	Description
PRO1LS	Momentary Button with Lever Kit



Stock Code	Description
PROBK	Blank Kit - No Trigger



CABLE TERMINATIONS



BG Configuration – Single 3/8" BSP (UK Air Cooled)

A	Stock Code	Description	Model
1	57Y01OB	Power Cable 12.5ft Rubber 3/8" BSP	PRO9, 17
	57Y03OB	Power Cable 25ft Rubber 3/8" BSP	PRO9, 17
	46V28OB	Power Cable 12.5ft Rubber 3/8" BSP	PRO26
	46V30OB	Power Cable 25ft Rubber 3/8" BSP	PRO26

BD Configuration – Large Dinse 3/8" BSP on Gas (UK Air Cooled)

B	Stock Code	Description	Model
1	57Y01OB	Power Cable 12.5ft Rubber 3/8" BSP	PRO9, 17
	57Y03OB	Power Cable 25ft Rubber 3/8" BSP	PRO9, 17
	46V28OB	Power Cable 12.5ft Rubber 3/8" BSP	PRO26
	46V30OB	Power Cable 25ft Rubber 3/8" BSP	PRO26
2	D3595-1-1	Dinse Power Adaptor	All

EG Configuration – Central Connector (UK Air Cooled)

C	Stock Code	Description	Model
1	57Y01OB	Power Cable 12.5ft Rubber 3/8" BSP	PRO9, 17
	57Y03OB	Power Cable 25ft Rubber 3/8" BSP	PRO9, 17
	46V28OB	Power Cable 12.5ft Rubber 3/8" BSP	PRO26
	46V30OB	Power Cable 25ft Rubber 3/8" BSP	PRO26
2	ER8006	Cable Support	
3	ER1518	Gun Plug Housing	
4	ER1519	Gun Plug Nut	
NI	608538	1/4" BSP to 3/8" BSP Adaptor	
5	C537	Central Connector Body	

WG Configuration – WTG Connector (UK Air Cooled)

D	Stock Code	Description	Model
1	57Y01-F12OB	Power Cable 12.5ft M12 Female	PRO9, 17
	57Y03-F12OB	Power Cable 25ft M12 Female	PRO9, 17
	46V28-F12OB	Power Cable 12.5ft M12 Female	PRO26
	46V30-F12OB	Power Cable 25ft M12 Female	PRO26
2	ER8006	Cable Support	
3	ER1518	Gun Plug Housing	
4	ER1519	Gun Plug Nut	
5	ER-WTG	WTG Body	

LG Configuration – L-Tec Euro (UK Air Cooled)

E	Stock Code	Description	Model
1	57Y01-F10OB	Power Cable 12.5ft M10 Male	PRO9, 17
	57Y03-F10OB	Power Cable 25ft M10 Male	PRO9, 17
	46V28-F10OB	Power Cable 12.5ft M10 Male	PRO26
	46V30-F10OB	Power Cable 25ft M10 Male	PRO26
2	ER8006	Cable Support	
3	ER1518	Gun Plug Housing	
4	ER1519	Gun Plug Nut	
5	ER-LTEC	LTEC Body	

CABLE TERMINATIONS

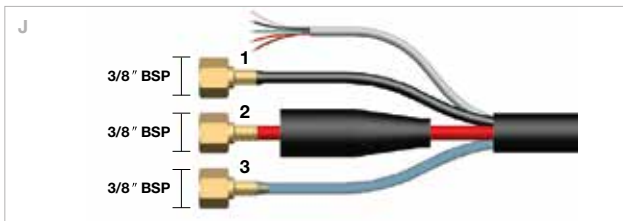
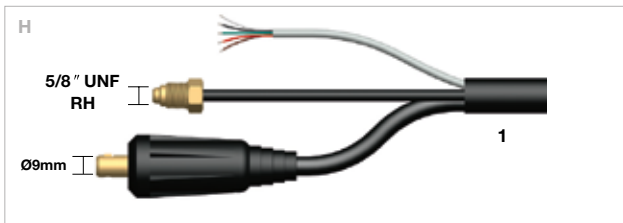
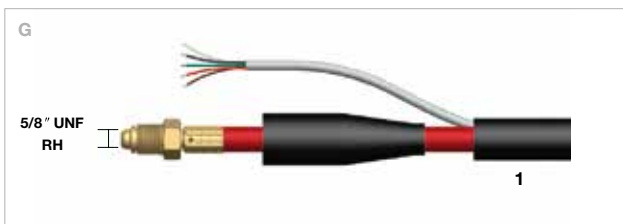
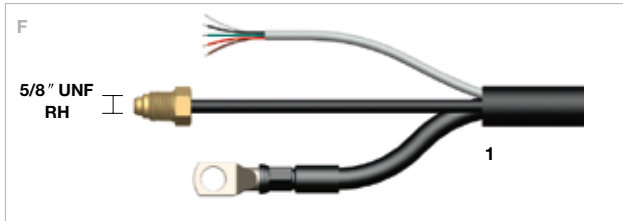

US Configuration – Lug on Power, 5/8" UNF RH Male on Gas (US Air cooled)

F	Stock Code	Description	Model
1	57Y01-2A	Power Cable 12.5ft Lug on Power 5/8" UNF on Gas	PRO9, 17
	57Y03-2A	Power Cable 25ft Lug on Power 5/8" UNF on Gas	PRO9, 17
	46V28-2A	Power Cable 12.5ft Lug on Power 5/8" UNF on Gas	PRO26
	46V03-2A	Power Cable 25ft Lug on Power 5/8" UNF on Gas	PRO26

UN Configuration – Single 5/8" UNF RH Male on Gas (US Air cooled)

G	Stock Code	Description	Model
1	57Y01ANOB	Power Cable 12.5ft 5/8" UNF	PRO9, 17
	57Y03ANOB	Power Cable 25ft 5/8" UNF	PRO9, 17
	46V28ANOB	Power Cable 12.5ft 5/8" UNF	PRO26
	46V30ANOB	Power Cable 25ft 5/8" UNF	PRO26

UD Configuration – 35-95 Dinse on Power, 5/8" UNF RH Male on Gas (US Air Cooled)

H	Stock Code	Description	Model
1	57Y01ADOB	Power Cable 12.5ft Dinse Power 5/8" UNF Gas	PRO9, 17
	57Y03ADOB	Power Cable 25ft Dinse Power 5/8" UNF Gas	PRO9, 17
	46V28ADOB	Power Cable 12.5ft Dinse Power 5/8" UNF Gas	PRO26
	46V30ADOB	Power Cable 25ft Dinse Power 5/8" UNF Gas	PRO26

A Configuration – 5/8" UNF RH Male (US Air Cooled)

I	Stock Code	Description	Model
1	57Y01AOB	Power Cable 12.5ft 3/8" UNF	PRO9, 17
	57Y03AOB	Power Cable 25ft 3/8" UNF	PRO9, 17
	46V28AOB	Power Cable 12.5ft 3/8" UNF	PRO26
	46V30AOB	Power Cable 25ft 3/8" UNF	PRO26

BW Configuration – 3/8" BSP Water, Gas and Power (UK Water Cooled)

J	Stock Code	Description	Model
1	45V07OB	Water Hose 12.5ft 3/8" BSP	PRO18,SC,20
	45V08OB	Water Hose 25ft 3/8" BSP	PRO18,SC,20
2	40V64OB	Power Cable 12.5ft 3/8" BSP	PRO18
	40V29OB	Power Cable 25ft 3/8" BSP	PRO18
	45V03OB	Power Cable 12.5ft 3/8" BSP	PRO20
	45V04OB	Power Cable 25ft 3/8" BSP	PRO20
3	45V74OB	Gas Hose 12.5ft 3/8" BSP	PRO18,SC
	45V32OB	Gas Hose 25ft 3/8" BSP	PRO18,SC
	45V09OB	Gas Hose 12.5ft 3/8" BSP	PRO20
	45V10OB	Gas Hose 25ft 3/8" BSP	PRO20

CABLE TERMINATIONS

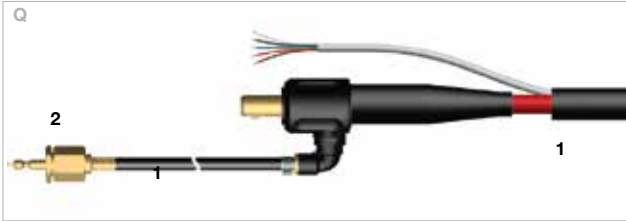

MG Configuration – Large Dinse Migatronic QF on Gas

Q	Stock Code	Description	Model
1	57Y01OB	Power Cable 12.5ft Rubber 3/8" BSP	PRO9, 17
	57Y03OB	Power Cable 25ft Rubber 3/8" BSP	PRO9, 17
	46V28OB	Power Cable 12.5ft Rubber 3/8" BSP	PRO26
	46V30OB	Power Cable 25ft Rubber 3/8" BSP	PRO26
2	D3595-1-M	Dinse Power Adaptor	All



LNG Configuration – Large Dinse Lincoln QF on Gas

R	Stock Code	Description	Model
1	57Y01OB	Power Cable 12.5ft Rubber 3/8" BSP	PRO9, 17
	57Y03OB	Power Cable 25ft Rubber 3/8" BSP	PRO9, 17
	46V28OB	Power Cable 12.5ft Rubber 3/8" BSP	PRO26
	46V30OB	Power Cable 25ft Rubber 3/8" BSP	PRO26
2	D3595-1-L	Dinse Power Adaptor	All



EMG Configuration – Large dinse 1/4 BSP on Gas

S	Stock Code	Description	Model
1	57Y01OB	Power Cable 12.5ft Rubber 3/8" BSP	PRO9, 17
	57Y03OB	Power Cable 25ft Rubber 3/8" BSP	PRO9, 17
	46V28OB	Power Cable 12.5ft Rubber 3/8" BSP	PRO26
	46V30OB	Power Cable 25ft Rubber 3/8" BSP	PRO26
2	D3595-1-4	Dinse Power Adaptor	All

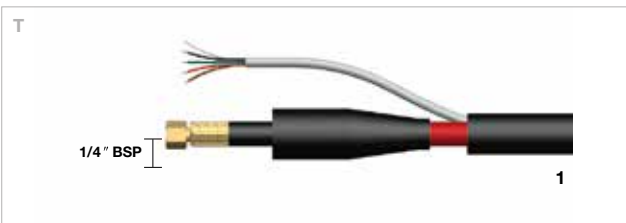

KG Configuration – 1/4" BSP (Air Cooled)

T	Stock Code	Description	Model
1	57Y01-F12OB	Power Cable 12.5ft 1/4" BSP Female	PRO9, 17
	57Y03-F12OB	Power Cable 25ft 1/4" BSP Female	PRO9, 17
	46V28-F12OB	Power Cable 12.5ft 1/4" BSP Female	PRO26
	46V30-F12OB	Power Cable 25ft 1/4" BSP Female	PRO26

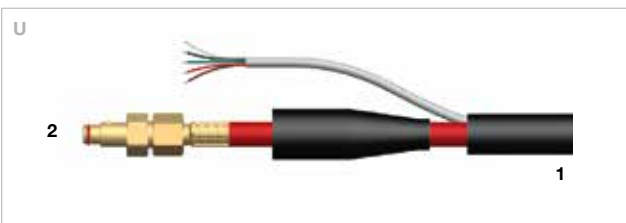

TG Configuration – Through Gas Dinse 35-50mm (Air Cooled)

U	Stock Code	Description	Model
1	57Y01OB	Power Cable 12.5ft Rubber 3/8" BSP	PRO9, 17
	57Y03OB	Power Cable 25ft Rubber 3/8" BSP	PRO9, 17
	46V28OB	Power Cable 12.5ft Rubber 3/8" BSP	PRO26
	46V30OB	Power Cable 25ft Rubber 3/8" BSP	PRO26
2	XTI-TG	Through gas Dinse Adaptor	All

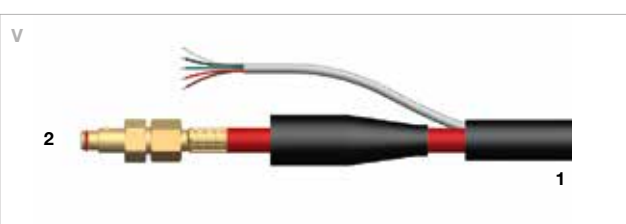

SG Configuration – SAF Through Gas Dinse 35-50mm (Air Cooled)

V	Stock Code	Description	Model
1	57Y01OB	Power Cable 12.5ft Rubber 3/8" BSP	PRO9, 17
	57Y03OB	Power Cable 25ft Rubber 3/8" BSP	PRO9, 17
	46V28OB	Power Cable 12.5ft Rubber 3/8" BSP	PRO26
	46V30OB	Power Cable 25ft Rubber 3/8" BSP	PRO26
2	SAF3550	SAF Through gas Dinse Adaptor	All

CABLE TERMINATIONS

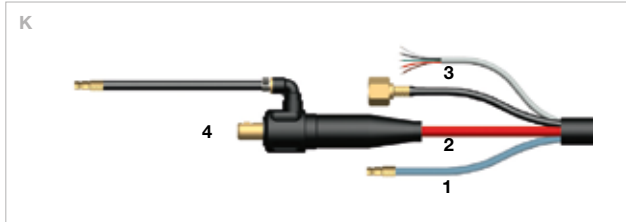

DQ Configuration – 35-50 Dinse on Power, Quick Fit on Water In/ Out, 3/8" BSP RH Male on Gas (Water Cooled)

K	Stock Code	Description	Model
1	45V07OBQD	Water Hose 12.5ft 3/8" BSP Quick fit	PRO18,SC,20
	45V08OBQD	Water Hose 25ft 3/8" BSP Quick fit	PRO18,SC,20
2	45V03OB	Power Cable 12.5ft 3/8" BSP	PRO20
	45V04OB	Power Cable 25ft 3/8" BSP	PRO20
	45V64OB	Power Cable 12.5ft 3/8" BSP	PRO18,SC
	45V29OB	Power Cable 25ft 3/8" BSP	PRO18,SC
	45V09OB	Gas Hose 12.5ft 3/8" BSP	PRO20
3	45V10OB	Gas Hose 25ft 3/8" BSP	PRO20
	45V74OB	Gas Hose 12.5ft 3/8" BSP	PRO18,SC
	45V32OB	Gas Hose 25ft 3/8" BSP	PRO18,SC
	4	D3595-1-QF	Dinse Adaptor 35-50 c/w Quick Fit

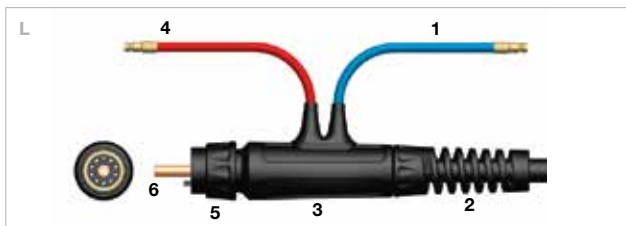

EW Configuration – Central Connector (UK Water Cooled)

L	Stock Code	Description	Model
1	45V07OBQD	Water Hose 12.5ft Quick Connect	PRO20
	45V08OBQD	Water Hose 25ft Quick Connect	PRO 20
NI	40V64-F12R	Power Cable 12.5ft M12	PRO18,SC
	40V29-F12R	Power Cable 25ft M12	PRO18,SC
	40V03F12OB	Power Cable 12.5ft M12	PRO20
	40V04F12OB	Power Cable 25ft M12	PRO20
NI	45V09NOB	Gas Hose 12.5ft	PRO20
	45V10NOB	Gas Hose 25ft	PRO20
	45V74NOB	Gas Hose 12.5ft	PRO18,SC
	45V32NOB	Gas Hose 25ft	PRO18,SC
	2	ER8007	Cable Support
3	ER5022	Gun Plug Housing	
4	ERS5017	Water Outlet Hose	
5	ER1519	Gun Plug Nut	
NI	C550	Power Gas Connector	
6	C525	Central Connector Body	

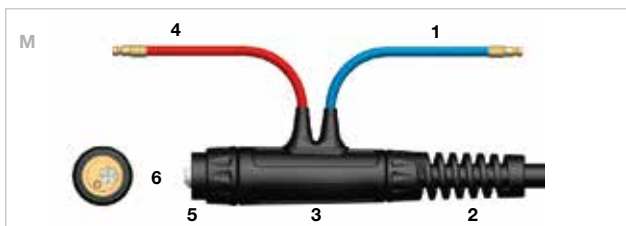

WW Configuration – WTW Connector (UK Water Cooled)

M	Stock Code	Description	Model
1	45V07OBQD	Water Hose 12.5ft Quick Connect	PRO18,SC,20
	45V08OBQD	Water Hose 25ft Quick Connect	PRO18,SC,20
NI	45V03-OBF12	Power Cable 12.5ft M12	PRO20
	45V04-OBF12	Power Cable 25ft M12	PRO20
	40V64-F12R	Power Cable 12.5ft M12	PRO18,SC,20
	40V29-F12R	Power Cable 25ft M12	PRO18,SC,20
NI	45V09NOB	Gas Hose 12.5ft	PRO20
	45V10NOB	Gas Hose 25ft	PRO20
	45V74NOB	Gas Hose 12.5ft	PRO18,SC
	45V32NOB	Gas Hose 25ft	PRO18,SC
	2	ER8007	Cable Support
3	ER5022	Gun Plug Housing	
4	ERS5017	Water Outlet Hose	
5	ER1519	Gun Plug Nut	
6	ER-WTW	WTW Body	

CABLE TERMINATIONS

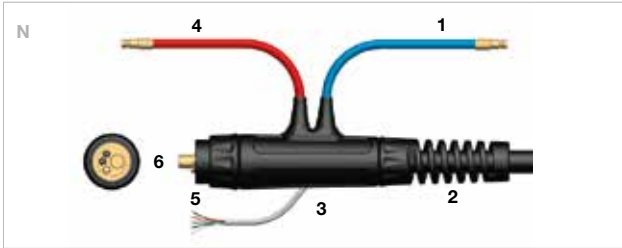

LW Configuration – L-Tec Euro (UK Water Cooled)

N	Stock Code	Description	Model
1	45V07OBQD	Water Hose 12.5ft Quick Connect	PRO18,SC,20
	45V08OBQD	Water Hose 25ft Quick Connect	PRO18,SC,20
NI	45V03-OBF12	Power Cable 12.5ft M12	PRO20
	45V04-OBF12	Power Cable 25ft M12	PRO20
	40V64-F12OB	Power Cable 12.5ft M12	PRO18
	40V29-F12OB	Power Cable 25ft M12	PRO18
NI	45V09NOB	Gas Hose 12.5ft	PRO20
	45V10NOB	Gas Hose 25ft	PRO20
	45V74NOB	Gas Hose 12.5ft	PRO18,SC
	45V32NOB	Gas Hose 25ft	PRO18,SC
2	ER8007	Cable Support	
3	ER5022	Gun Plug Housing	
4	ERS5017	Water Outlet Hose	
5	ER1519	Gun Plug Nut	
6	ER-LTW	L-Tec Body	

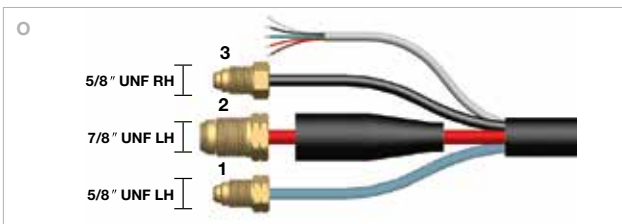

UW Configuration – 7/8" UNF LH on Power, 5/8" UNF RH Male on Gas, 5/8" UNF LH Male on Water (US Water Cooled)

O	Stock Code	Description	Model
1	45V07OBA	Water Hose 12.5ft 5/8" UNF LH	PRO18,SC,20
	45V08OBA	Water Hose 25ft 5/8" UNF LH	PRO18,SC,20
2	45V64OBA	Power Cable 12.5ft 7/8" UNF LH	PRO18,SC
	45V29OBA	Power Cable 25ft 7/8" UNF LH	PRO18,SC
NI	45V03OBA	Power Cable 12.5ft 7/8" UNF LH	PRO20
	45V04OBA	Power Cable 25ft 7/8" UNF LH	PRO20
3	45V74OBA	Gas Hose 12.5ft 5/8" UNF	PRO18,SC
	45V32OBA	Gas Hose 25ft 5/8" UNF	PRO18,SC
	45V09OBA	Gas Hose 12.5ft 5/8" UNF	PRO20
	45V10OBA	Gas Hose 25ft 5/8" UNF	PRO20

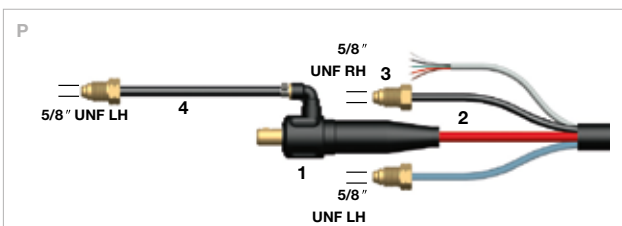

UE Configuration – 35-95 Dinse on Power, 5/8" UNF RH on Water In/Out, 5/8" UNF RH Male on Gas (US Water Cooled)

P	Stock Code	Description	Model
1	45V07OBA	Water Hose 12.5ft 5/8" UNF LH	PRO18,SC,20
	45V08OBA	Water Hose 25ft 5/8" UNF LH	PRO18,SC,20
2	45V03OB	Power Cable 12.5ft 3/8" BSP	PRO20
	45V04OB	Power Cable 25ft 3/8" BSP	PRO20
	40V64OB	Power Cable 12.5ft 3/8" BSP	PRO18,SC
	40V29OB	Power Cable 25ft 3/8" BSP	PRO18,SC
3	45V09OBA	Gas Hose 12.5ft 5/8" UNF RH	PRO20
	45V10OBA	Gas Hose 25ft 5/8" UNF RH	PRO20
	45V74OBA	Gas Hose 12.5ft 5/8" UNF RH	PRO18,SC
	45V32OBA	Gas Hose 25ft 5/8" UNF RH	PRO18,SC
4	D3595-1 UNF	Dinse Adaptor 35-95 c/w 5/8" UNF	

CABLE TERMINATIONS



LRG Configuration – Large Dinse Lorch QF on Gas

V	Stock Code	Description	Model
1	57Y01OB	Power Cable 12.5ft Rubber 3/8" BSP	PRO9, 17
	57Y03OB	Power Cable 25ft Rubber 3/8" BSP	PRO9, 17
	46V28OB	Power Cable 12.5ft Rubber 3/8" BSP	PRO26
	46V30OB	Power Cable 25ft Rubber 3/8" BSP	PRO26
2	D3595-1-L	Dinse Power Adaptor	All

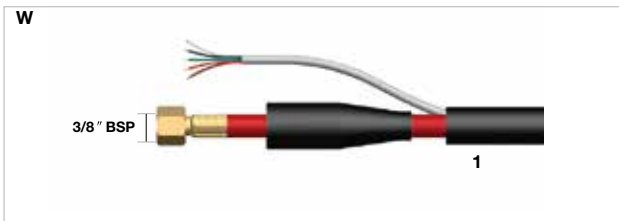

FRG Configuration – Fronius 3/8" BSP

W	Stock Code	Description	Model
1	57Y01OB	Power Cable 12.5ft Rubber 3/8" BSP	PRO9, 17
	57Y03OB	Power Cable 25ft Rubber 3/8" BSP	PRO9, 17
	46V28OB	Power Cable 12.5ft Rubber 3/8" BSP	PRO26
	46V30OB	Power Cable 25ft Rubber 3/8" BSP	PRO26

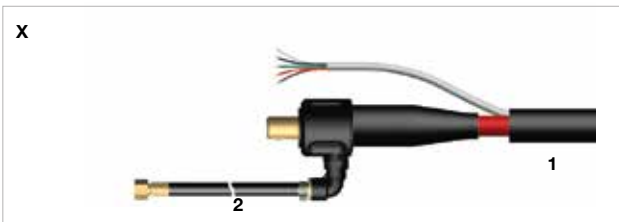

EMG Configuration – Large dinse 1/8 BSP on Gas (ESAB)

X	Stock Code	Description	Model
1	57Y01OB	Power Cable 12.5ft Rubber 3/8" BSP	PRO9, 17
	57Y03OB	Power Cable 25ft Rubber 3/8" BSP	PRO9, 17
	46V28OB	Power Cable 12.5ft Rubber 3/8" BSP	PRO26
	46V30OB	Power Cable 25ft Rubber 3/8" BSP	PRO26
2	D3595-1-8	Dinse Power Adaptor	All



MPG Configuration – MIG Euro (Multiprocess machines)

Y	Stock Code	Description	Model
1	57Y01OB	Power Cable 12.5ft Rubber 3/8" BSP	PRO9, 17
	57Y03OB	Power Cable 25ft Rubber 3/8" BSP	PRO9, 17
	46V28OB	Power Cable 12.5ft Rubber 3/8" BSP	PRO26
	46V30OB	Power Cable 25ft Rubber 3/8" BSP	PRO26
2		Euro connector	All



CABLE TERMINATIONS

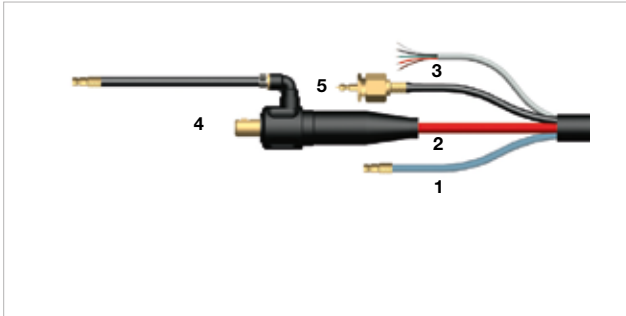

MW Configuration – 35-39 Dinse on Power, Quick Fit on Water In/Out, Migatronc Gas quick fit (Water Cooled)

Z	Stock Code	Description	Model
1	45V07OBQD	Water Hose 12.5ft 3/8" BSP Quick fit	PRO18,SC,20
	45V08OBQD	Water Hose 25ft 3/8" BSP Quick fit	PRO18,SC,20
2	45V03OB	Power Cable 12.5ft 3/8" BSP	PRO20
	45V04OB	Power Cable 25ft 3/8" BSP	PRO20
	45V64OB	Power Cable 12.5ft 3/8" BSP	PRO18,SC
	45V29OB	Power Cable 25ft 3/8" BSP	PRO18,SC
3	45V09OB	Gas Hose 12.5ft 3/8" BSP	PRO20
	45V10OB	Gas Hose 25ft 3/8" BSP	PRO20
	45V74OB	Gas Hose 12.5ft 3/8" BSP	PRO18,SC
	45V32OB	Gas Hose 25ft 3/8" BSP	PRO18,SC
4	D3595-1-QF	Dinse Adaptor 35-50 c/w Quick Fit	All
	608618	Gas Quick Fit Migatronc	All

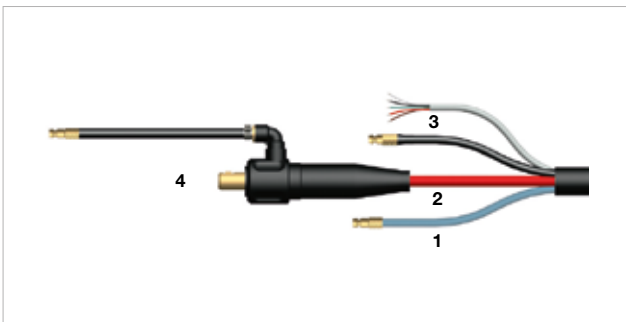

LNW Configuration – 35-39 Dinse on Power, Quick Fit on Water In/Out, Lincoln Gas quick fit (Invertec)

A1	Stock Code	Description	Model
1	45V07OBDQ	Water Hose 12.5ft 3/8" BSP Quick fit	PRO20
	45V09OBDQ	Water Hose 25ft 3/8" BSP Quick fit	PRO20
	45V07OBQD	Water Hose 12.5ft 3/8" BSP Quick fit	PRO18, 18SC
	45V08OBQD	Water Hose 25ft 3/8" BSP Quick fit	PRO18, 18SC
2	45V03OB	Power Cable 12.5ft 3/8" BSP	PRO20
	45V04OB	Power Cable 25ft 3/8" BSP	PRO20
	45V64OB	Power Cable 12.5ft 3/8" BSP	PRO18, 18SC
	45V29OB	Power Cable 25ft 3/8" BSP	PRO18, 18SC
3	45V09OBL	Gas Hose 12.5ft 3/8" BSP	PRO20
	45V10OBL	Gas Hose 25ft 3/8" BSP	PRO20
	45V74OBL	Gas Hose 12.5ft 3/8" BSP	PRO18, 18SC
	45V32OBL	Gas Hose 25ft 3/8" BSP	PRO18, 18SC
4	D3595-1-QF	Dinse Adaptor 35-50 c/w Quick Fit	All

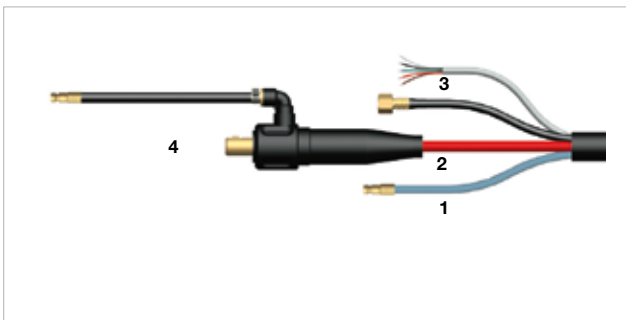

EMW Configuration – 35-95 Dinse on Power, Quick Fit on Water In/Out, 1/4" BSP on Gas (EWM)

A2	Stock Code	Description	Model
1	45V07OBDQ	Water Hose 12.5ft 3/8" BSP Quick fit	PRO18,SC,20
	45V08OBDQ	Water Hose 25ft 3/8" BSP Quick fit	PRO18,SC,20
2	45V03OB	Power Cable 12.5ft 3/8" BSP	PRO18,20
	45V04OB	Power Cable 25ft 3/8" BSP	PRO18,20
	45V64OB	Power Cable 12.5ft 3/8" BSP	PRO18,SC
	45V29OB	Power Cable 25ft 3/8" BSP	PRO18,SC
3	45V09OB-1/4	Gas Hose 12.5ft 1/4" BSP	PRO20
	45V10OB-1/4	Gas Hose 25ft 1/4" BSP	PRO20
	45V74OB-1/4	Gas Hose 12.5ft 1/4" BSP	PRO18,SC
	45V32OB-1/4	Gas Hose 25ft 1/4" BSP	PRO18,SC
4	D3595-1-QF	Dinse Adaptor 35-50 c/w Quick Fit	All

CABLE PLUGS



Stock Code	Description	Machine
A ERCP0	2 Pin Amphenol Plug	Esab®/Murex®



Stock Code	Description	Machine
B ERCP1	4 Pin Amphenol Plug	Kemppi®



Stock Code	Description	Machine
C ERCP2	5 Pin Amphenol Plug	Miller®



Stock Code	Description	Machine
D ERCP3	6 Pin Amphenol Plug	Lincoln®



Stock Code	Description	Machine
E ERCP4	14 Pin Amphenol Plug	Miller®



Stock Code	Description	Machine
F ERCP5	6 Pin Harting Plug	Migatronic®



Stock Code	Description	Machine
G ERCP6	8 Pin Plug	Thermal Arc



Stock Code	Description	Machine
H ERCP7	3 Pin Tuchel Plug	Messer®



Stock Code	Description	Machine
I ERCP8	9 Pin Tuchel Plug	Fronius®



Stock Code	Description	Machine
J ERCP9	5 Pin Tuchel Plug	Messer®/EWM®/Lincoln®



Stock Code	Description	Machine
K ERCP10	12 Pin Bundy Plug	Esab®

CABLE PLUGS



Stock Code	Description	Machine
L ERCP11	7 Pin Migatronc Plug	Migatronc®



Stock Code	Description	Machine
M ERCP12	2 Pin XTI Inverter Plug	Parweld XTI 180



Stock Code	Description	Machine
N ERCP14	5 Pin XTI Inverter Plug	Parweld XTI 200



Stock Code	Description	Machine
O ERCP16	5 Pin Amphenol	Lincoln®



Stock Code	Description	Machine
P ERCP18	14 Pin XTI Inverter Plug	Parweld XTI 201/303



Stock Code	Description	Machine
Q ERCP19	5 Pin XTI Inverter Plug	Parweld XTI181



Stock Code	Description	Machine
R ERCP20	3 Pin XTI Inverter Plug	Parweld XTI601MP



Stock Code	Description	Machine
S ERCP21	2 Pin Push Fit	Esab®

TUNGSTEN ELECTRODES



2% Thoriated Tungsten's 175mm

Stock Code	Description
1.0MM 2%/175	1.0mm 175mm Tungsten 2% Thoriated
1.2MM 2%/175	1.2mm 175mm Tungsten 2% Thoriated
1.6MM 2%/175	1.6mm 175mm Tungsten 2% Thoriated
2.0MM 2%/175	2.0mm 175mm Tungsten 2% Thoriated
2.4MM 2%/175	2.4mm 175mm Tungsten 2% Thoriated
3.2MM 2%/175	3.2mm 175mm Tungsten 2% Thoriated
4.0MM 2%/175	4.0mm 175mm Tungsten 2% Thoriated
4.8MM 2%/175	4.8mm 175mm Tungsten 2% Thoriated
6.4MM 2%/175	6.4mm 175mm Tungsten 2% Thoriated

Pure Tungsten's 175mm

Stock Code	Description
1.0MM P/175	1.0mm 175mm Tungsten Pure
1.6MM P/175	1.6mm 175mm Tungsten Pure
2.0MM P/175	2.0mm 175mm Tungsten Pure
2.4MM P/175	2.4mm 175mm Tungsten Pure
3.2MM P/175	3.2mm 175mm Tungsten Pure
4.8MM P/175	4.8mm 175mm Tungsten Pure

1% Lanthanum Tungsten's 175mm

Stock Code	Description
1.0MM L/175	1.0mm 175mm Tungsten Lanthanum
1.6MM L/175	1.6mm 175mm Tungsten Lanthanum
2.4MM L/175	2.4mm 175mm Tungsten Lanthanum

0.9% Zirconiated Tungsten's 175mm

Stock Code	Description
1.0MM Z/175	1.0mm 175mm Tungsten Zirconiated
1.6MM Z/175	1.6mm 175mm Tungsten Zirconiated
2.4MM Z/175	2.4mm 175mm Tungsten Zirconiated
3.2MM Z/175	3.2mm 175mm Tungsten Zirconiated
4.0MM Z/175	4.0mm 175mm Tungsten Zirconiated
4.8MM Z/175	4.8mm 175mm Tungsten Zirconiated

2% Ceriated Tungsten's 175mm

Stock Code	Description
1.2MM C/175	1.2mm 175mm Tungsten Ceriated
1.6MM C/175	1.6mm 175mm Tungsten Ceriated
2.0MM C/175	2.0mm 175mm Tungsten Ceriated
2.4MM C/175	2.4mm 175mm Tungsten Ceriated
3.2MM C/175	3.2mm 175mm Tungsten Ceriated
4.0MM C/175	4.0mm 175mm Tungsten Ceriated
4.8MM C/175	4.8mm 150mm Tungsten Ceriated

1.5% Lanthanum Tungsten's 175mm

Stock Code	Description
1.6MM G/175	1.6mm 175mm Tungsten Lanthanum (Gold)
2.4MM G/175	2.4mm 175mm Tungsten Lanthanum (Gold)

KERAMISCHE GASMONDSTUKKEN

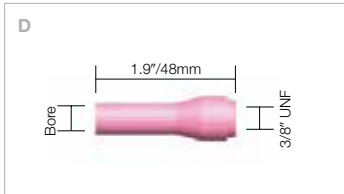
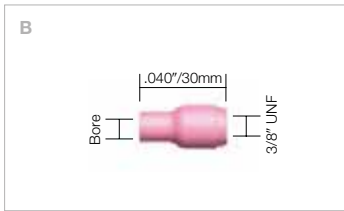
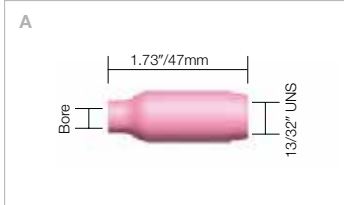

Ceramics

Stock Code	Description	Size	Bore	Model
A 10N44	Standard Ceramic Cup	12	3/4" 19 mm	ER/WP17, 18, 26
10N45	Standard Ceramic Cup	10	5/8" 16 mm	ER/WP17, 18, 26
10N46	Standard Ceramic Cup	8	1/2" 13 mm	ER/WP17, 18, 26
10N47	Standard Ceramic Cup	7	7/16" 11 mm	ER/WP17, 18, 26
10N48	Standard Ceramic Cup	6	3/8" 10 mm	ER/WP17, 18, 26
10N49	Standard Ceramic Cup	5	5/16" 8 mm	ER/WP17, 18, 26
10N50	Standard Ceramic Cup	4	1/4" 6 mm	ER/WP17, 18, 26

Stock Code	Description	Size	Bore	Model
B 13N08	Standard Ceramic Cup	4	1/4" 6 mm	ER/WP9, 20
13N09	Standard Ceramic Cup	5	5/16" 8 mm	ER/WP9, 20
13N10	Standard Ceramic Cup	6	3/8" 10 mm	ER/WP9, 20
13N11	Standard Ceramic Cup	7	7/16" 11 mm	ER/WP9, 20
13N12	Standard Ceramic Cup	8	1/2" 13 mm	ER/WP9, 20
13N13	Standard Ceramic Cup	10	5/8" 16 mm	ER/WP9, 20

Long Ceramics

Stock Code	Description	Size	Bore	Model
C 10N47L	Long Ceramic Cup	7L	7/16" 11 mm	ER/WP17, 18, 26
10N48L	Long Ceramic Cup	6L	3/8" 10 mm	ER/WP17, 18, 26
10N49L	Long Ceramic Cup	5L	5/16" 8 mm	ER/WP17, 18, 26

Long Ceramic Cups

Stock Code	Description	Size	Bore	Model
D 796F70	Long Ceramic Cup	3L	3/16" 5 mm	ER/WP9, 20
796F71	Long Ceramic Cup	4L	1/4" 6 mm	ER/WP9, 20
796F72	Long Ceramic Cup	5L	5/16" 8 mm	ER/WP9, 20
796F73	Long Ceramic Cup	6L	3/8" 10 mm	ER/WP9, 20

Stock Code	Description	Size	Bore	Model
E 796F74	Extra Long Ceramic Cup	3XL	3/16" 5 mm	ER/WP9, 20

Stock Code	Description	Size	Bore	Model
F 796F75	Extra Long Ceramic Cup	4XL	1/4" 6 mm	ER/WP9, 20
796F76	Extra Long Ceramic Cup	5XL	5/16" 8 mm	ER/WP9, 20
796F77	Extra Long Ceramic Cup	6XL	3/8" 10 mm	ER/WP9, 20

Long Gas Lens Ceramics

Stock Code	Description	Size	Bore	Model
G 54N15L	Long Gas Lens Ceramic Cup	7L	7/16" 11 mm	ER/WP17, 18, 26
54N16L	Long Gas Lens Ceramic Cup	6L	3/8" 10 mm	ER/WP17, 18, 26
54N17L	Long Gas Lens Ceramic Cup	5L	5/16" 8 mm	ER/WP17, 18, 26

KERAMISCHE GASMONDSTUKKEN EN SPANTANGEN

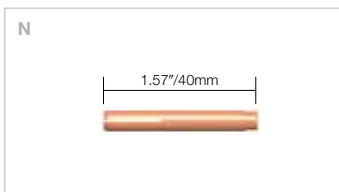
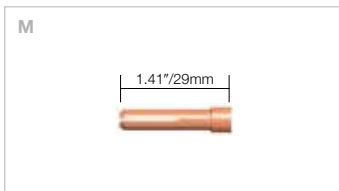
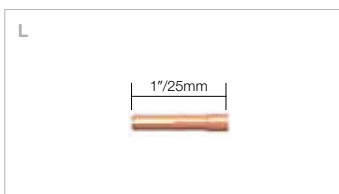
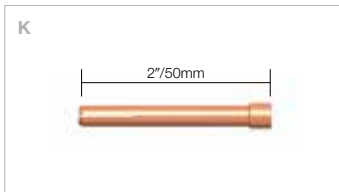
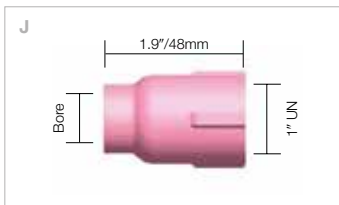
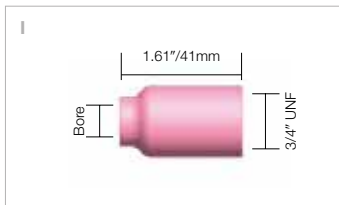
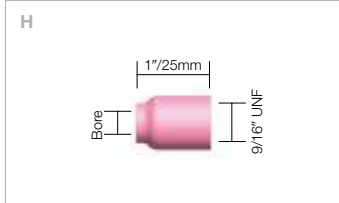

Gas Lens Ceramics

Stock Code	Description	Size	Bore	Model
H 53N58	Standard Gas Lens Cup	4	1/4" 6 mm	ER/WP9, 20
53N59	Standard Gas Lens Cup	5	5/16" 8 mm	ER/WP9, 20
53N60	Standard Gas Lens Cup	6	3/8" 10 mm	ER/WP9, 20
53N61	Standard Gas Lens Cup	7	7/16" 11 mm	ER/WP9, 20
53N61-S	Standard Gas Lens Cup	8	1/2" 13 mm	ER/WP9, 20

Stock Code	Description	Size	Bore	Model
I 54N14	Standard Gas Lens Cup	8	1/2" 13 mm	ER/WP17, 18, 26
54N15	Standard Gas Lens Cup	7	7/16" 11mm	ER/WP17, 18, 26
54N16	Standard Gas Lens Cup	6	3/8" 10 mm	ER/WP17, 18, 26
54N17	Standard Gas Lens Cup	5	5/16" 8 mm	ER/WP17, 18, 26
54N18	Standard Gas Lens Cup	4	1/4" 6 mm	ER/WP17, 18, 26
54N19	Standard Gas Lens Cup	11	11/16" 18 mm	ER/WP17, 18, 26

Stock Code	Description	Size	Bore	Model
J 53N87	Large Dia Gas Lens Cup	12	3/4" 19 mm	ER/WP17, 18, 26, 9, 20
53N88	Large Dia Gas Lens Cup	10	5/8" 16 mm	ER/WP17, 18, 26, 9, 20
57N75	Large Dia Gas Lens Cup	6	3/8" 10 mm	ER/WP17, 18, 26, 9, 20
57N74	Large Dia Gas Lens Cup	8	1/2" 13 mm	ER/WP17, 18, 26, 9, 20

Collets

Stock Code	Description	Electrode	Model
K 10N21	Standard Collet	.020" 0.5 mm	ER/WP17, 18, 26
10N22	Standard Collet	.040" 1.0 mm	ER/WP17, 18, 26
10N23	Standard Collet	1/16" 1.6 mm	ER/WP17, 18, 26
10N26	Standard Collet	5/64" 2.0 mm	ER/WP17, 18, 26
10N24	Standard Collet	3/32" 2.4 mm	ER/WP17, 18, 26
10N25	Standard Collet	1/8" 3.2 mm	ER/WP17, 18, 26
54N20	Standard Collet	5/32" 4.0 mm	ER/WP17, 18, 26

Stock Code	Description	Electrode	Model
L 13N20	Standard Collet	.020" 0.5 mm	ER/WP9, 20
13N21	Standard Collet	.040" 1.0 mm	ER/WP9, 20
13N22	Standard Collet	1/16" 1.6 mm	ER/WP9, 20
13N22M	Standard Collet	5/64" 2.0 mm	ER/WP9, 20
13N23	Standard Collet	3/32" 2.4 mm	ER/WP9, 20
13N24	Standard Collet	1/8" 3.2 mm	ER/WP9, 20

Stock Code	Description	Electrode	Model
M 10N21S	Stubby Collet	.020" 0.5 mm	ER/WP17, 18, 26
10N22S	Stubby Collet	.040" 1.0 mm	ER/WP17, 18, 26
10N23S	Stubby Collet	1/16" 1.6 mm	ER/WP17, 18, 26
10N24S	Stubby Collet	3/32" 2.4 mm	ER/WP17, 18, 26
10N25S	Stubby Collet	1/8" 3.2 mm	ER/WP17, 18,, 26

Stock Code	Description	Electrode	Model
N 13N22L	Large Diameter Gas Lens Collet	1/16" 1.6 mm	ER/WP9, 20
13N23L	Large Diameter Gas Lens Collet	3/32" 2.4 mm	ER/WP9, 20
13N24L	Large Diameter Gas Lens Collet	1/8" 3.2 mm	ER/WP9, 20

SPANTANGHOUDERS EN GASLENZEN

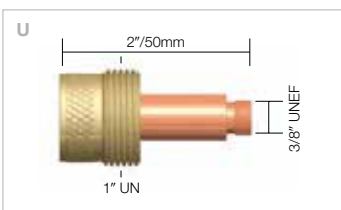
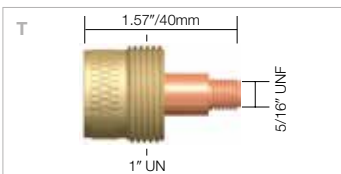
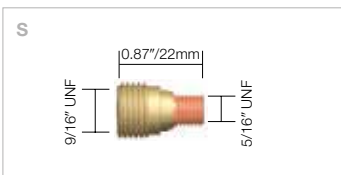
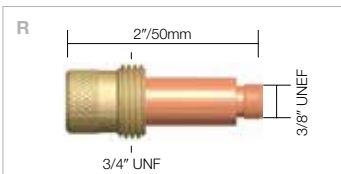
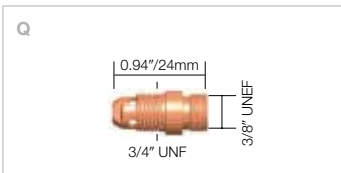
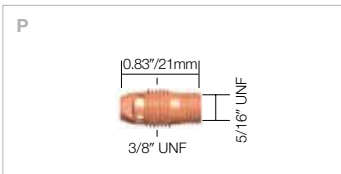

Collet Bodies

Stock Code	Description	Electrode	Model
O 10N29	Standard Collet Body	0.020" 0.5 mm	ER/WP17, 18, 26
10N30	Standard Collet Body	0.040" 1.0 mm	ER/WP17, 18, 26
10N31	Standard Collet Body	1/16" 1.6 mm	ER/WP17, 18, 26
10N31M	Standard Collet Body	5/64" 2.0 mm	ER/WP17, 18, 26
10N32	Standard Collet Body	3/32" 2.4 mm	ER/WP17, 18, 26
10N28	Standard Collet Body	1/8" 3.2 mm	ER/WP17, 18, 26
406488	Standard Collet Body	5/32" 4.0 mm	ER/WP17, 18, 26

Stock Code	Description	Electrode	Model
P 13N25	Standard Collet Body	0.020" 0.5 mm	ER/WP9, 20
13N26	Standard Collet Body	0.040" 1.0 mm	ER/WP9, 20
13N27	Standard Collet Body	1/16" 1.6 mm	ER/WP9, 20
13N27M	Standard Collet Body	5/64" 2.0 mm	ER/WP9, 20
13N28	Standard Collet Body	3/32" 2.4 mm	ER/WP9, 20
13N29	Standard Collet Body	1/8" 3.2 mm	ER/WP9, 20

Stock Code	Description	Electrode	Model
Q 17CB20	Stubby Collet Body	0.5mm-3.2mm	ER/WP17, 18, 26

Gas Lens Bodies

Stock Code	Description	Electrode	Model
R 45V29	Gas Lens Body	0.020" 0.5 mm	ER/WP17, 18, 26
45V24	Gas Lens Body	0.040" 1.0 mm	ER/WP17, 18, 26
45V25	Gas Lens Body	1/16" 1.6 mm	ER/WP17, 18, 26
45V25M	Gas Lens Body	5/64" 2.0 mm	ER/WP17, 18, 26
45V26	Gas Lens Body	3/32" 2.4 mm	ER/WP17, 18, 26
45V27	Gas Lens Body	1/8" 3.2 mm	ER/WP17, 18, 26
45V28	Gas Lens Body	5/32" 4.0 mm	ER/WP17, 18, 26

Stock Code	Description	Electrode	Model
S 45V41	Gas Lens Body	0.020" 0.5 mm	ER/WP9, 20
45V42	Gas Lens Body	0.040" 1.0 mm	ER/WP9, 20
45V43	Gas Lens Body	1/16" 1.6 mm	ER/WP9, 20
45V43M	Gas Lens Body	5/64" 2.0 mm	ER/WP9, 20
45V44	Gas Lens Body	3/32" 2.4 mm	ER/WP9, 20
45V45	Gas Lens Body	1/8" 3.2 mm	ER/WP9, 20

Stock Code	Description	Electrode	Model
T 45V116S	Large Diameter Gas Lens Body	1/16" 1.6 mm	ER/WP9, 20, 24
45V64S	Large Diameter Gas Lens Body	3/32" 2.4 mm	ER/WP9, 20, 24

Stock Code	Description	Electrode	Model
U 45V116	Large Diameter Gas Lens Body	1/16" 1.6 mm	ER/WP17, 18, 26
45V63	Large Diameter Gas Lens Body	5/32" 4.0 mm	ER/WP17, 18, 26
45V64	Large Diameter Gas Lens Body	3/32" 2.4 mm	ER/WP17, 18, 26
995795	Large Diameter Gas Lens Body	1/8" 3.2 mm	ER/WP17, 18, 26

BACK CAPS/INSULATORS



BACK CAPS

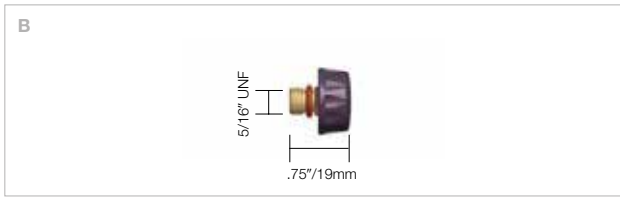

Stock Code	Description	Model	Colour
A ER41V24	Back Cap Long	ER/WP9/20	Purple
41V24	Back Cap Long	ER/WP9/20	Black

Stock Code	Description	Model	Colour
B ER41V33	Back Cap Short	ER/WP9/20	Purple
41V33	Back Cap Short	ER/WP9/20	Black

Stock Code	Description	Model	Colour
C ER41V35	Back Cap Medium	ER/WP9/20	Purple
41V35	Back Cap Medium	ER/WP9/20	Black

Stock Code	Description	Model	Colour
D ER57Y02	Back Cap Long	ER/WP17/18/26	Purple
57Y02	Back Cap Long	ER/WP17/18/26	Black

Stock Code	Description	Model	Colour
E ER57Y04	Back Cap Short	ER/WP17/18/26	Purple
57Y04	Back Cap Short	ER/WP17/18/26	Black

INSULATORS

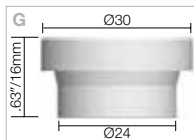
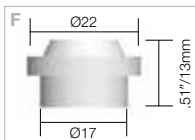
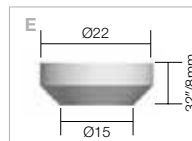
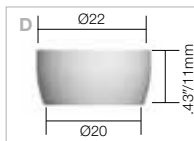
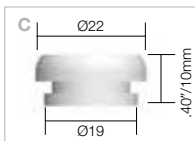
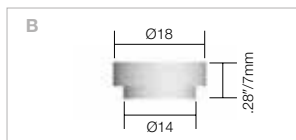
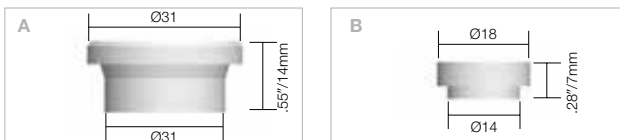

Stock Code	Description	Model
A 54N63-20	Insulator Large Diameter Gas Lens	ER/WP9/20
B 598882	Cup Gasket	ER/WP9/20
C 18-7	Rear Head Insert	ER/WP17/18/26
D 18CG	Cup Gasket	ER/WP17/18/26
E 18CG20	Cup Gasket for Stubby Collet Body	ER/WP17/18/26
F 54N01	Gas Lens Insulator (use with 18CG)	ER/WP17/18/26
G 54N63	Insulator Large Diameter Gas Lens (use with 18CG)	ER/WP17/18/26

GPPH LASTAFELS PREMIUM



**BETAALBAAR ÉN HOOGKWALITATIEF !
ONTDEK GPPH LASTAFELS**



- ✔ **Voordelen**
- ✔ No-nonsense lastafels: betaalbaar én hoogkwalitatief
- ✔ Duurzaam kwaliteitsstaal
- ✔ Compatibel met tools van de gekende merken
- ✔ Keuze uit diktes 8-12 en 15 mm tafelblad
- ✔ Gatens en tools van 16 en 28 mm verkrijgbaar
- ✔ Tafels met gaten Ø16 mm kunnen zowel in rooster 50x50 mm als 100x100 mm verkregen worden
- ✔ Tafels met gaten Ø28 mm worden geleverd in rooster 100x100 mm
- ✔ Minimale reflectie laslicht
- ✔ Gegraveerde schaal
- ✔ **Zijpanelen met 3 lijnen gaten (diagonale rasters) inbegrepen**
- ✔ **Verpakking en transport steeds inbegrepen in de prijs !**

KENMERKEN	ECO •	PLUS •	PRO •
Perfekte vlakheid van de tafel	✔	✔	✔
Gekalibreerde gaten	✔	✔	✔
Productiestandaard ISO 2768-1	✔	✔	✔
3 roosters van gaten aan de 4 zijden	✔	✔	✔
Dikte	8 mm	12 mm	15 mm
Afgeschuinde / gefreesde gaten	✘	✔	✔
Benen profiel	60x60 mm	80x80 mm	100x100 mm
Gefreesde werkbladranden	✘	✘	✔
Capaciteit	250 kg/poot	500 kg/poot	700 kg/poot

FORMAAT (MM)	ECO •	PLUS •	PRO •
1000x600	•	•	•
1000x1000	•	•	•
1200x800	•	•	•
1200x1000	•	•	•
1200x1200	•	•	•
1500x1000	•	•	•
1500x1480	•	•	•
2000x1000	•	•	•
2400x1200	•	•	•
3000x1480	•	•	•

OPTIE

POOT VOORZIEN VAN WIEL



TYPE: ECO •
ART.NR. 9144.1LEG.ECO

TYPE: PLUS •
ART.NR. 9144.1LEG.PLUS

TYPE: PRO •
ART.NR. 9144.1LEG.PRO

GPPH LASTAFELS BASIC

BETAALBAAR ÉN HOOGKwalitatief !
ONTDEK GPPH LASTAFELS



- Metalen frame versterkt met ribben (1)
- Werktafel met een dikte van 12 mm, gemaakt van S355J2+N staal (2)
- Vaste voeten of uitschuifbare draaivoeten (3)
- Tafels met gaten Ø16 zowel in rooster 50x50 mm als 100x100 mm verkrijgbaar. Tafels met gaten Ø28 in rooster 100x100 mm verkrijgbaar (4)
- Verstelbare tafelhoogte van 830 mm tot 930 mm (optioneel afgestemd op aanvraag) (5)

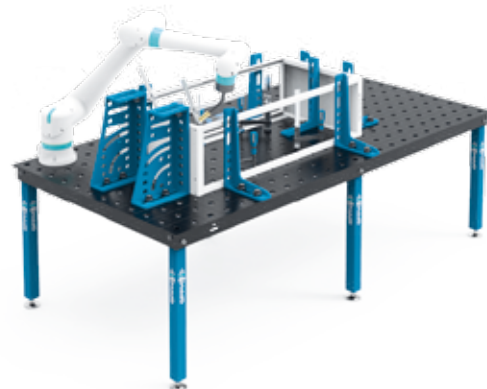

✓ Voordelen

- ✓ Perfecte vlakheid van de tafel [+/- 0,5 mm];
- ✓ Stabiele en massieve constructie, ongeveer 80 mm hoog;
- ✓ Tafels met gaten Ø16 zowel in rooster 50x50 mm als 100x100 mm verkrijgbaar. Tafels met gaten Ø28 in rooster 100x100 mm verkrijgbaar;
- ✓ Afgeschuinde en gefreesde gaten voor eenvoudige gereedschapsmontage;
- ✓ Gegraveerde schaal
- ✓ Hoogteverstelling van de tafel met standaard poten ca. 880-930 mm;
- ✓ Alle tafels zijn verstevigd met ribben;
- ✓ Gefreesde werkbladranden;
- ✓ Dikte 12 mm;
- ✓ Tafelpoten van profiel 60x60 mm;
- ✓ Capaciteit: 250 kg/been

FORMAAT (MM)	GEWICHT (KG)	CAPACITEIT (KG)	AANTAL POTEN
2400X1200	378	1500	6
2000X1000	272	1000	4
1500X1480	300	1000	4
1500X1000	217	1000	4
1200X1200	205	1000	4
1200X1000	180	1000	4
1200X800	148	1000	4
1000X1000	157	1000	4
1000X600	108	1000	4

GEREEDSCHAPPEN VOOR GPPH-LASTAFELS

TOOLKIT N°1

146
DELIG



 10x	 10x	 5x	 5x	 40x
 8x	 8x	 4x	 4x	 2x
 4x	 2x	 8x	 2x	 4x
 4x	 2x	 2x	 2x	 1x
 10x	 2x	 2x	 2x	 1x
 1x	 1x	<p>BESCHIKBAAR MET TOOLS PASSEND IN GATEN VAN 28 MM OF 16 MM</p> <p>TOOLKIT N°1 PLUS • ART.NR. 9144.TOOLKIT.PLUS.1</p> <p>TOOLKIT N°1 PRO • ART.NR. 9144.TOOLKIT.PRO.1</p>		

GEREEDSCHAPPEN VOOR GPPH-LASTAFELS

TOOLKIT N°2

93
DELIG



 8x	 4x	 2x	 2x	 30x
 6x	 6x	 4x	 2x	 1x
 4x	 2x	 4x	 2x	 2x
 2x	 1x	 1x	 4x	 2x
 2x	 1x	 1x	<p>BESCHIKBAAR MET TOOLS PASSEND IN GATEN VAN 28 MM OF 16 MM</p> <p>TOOLKIT N°2 PLUS • ART.NR. 9144.TOOLKIT.PLUS.2</p> <p>TOOLKIT N°2 PRO • ART.NR. 9144.TOOLKIT.PRO.2</p>	

GEREEDSCHAPPEN VOOR GPPH-LASTAFELS

TOOLKIT N°3

58
DELIG



GEREEDSCHAPPEN VOOR GPPH-LASTAFELS

TOOLKIT N°4

26
DELIG

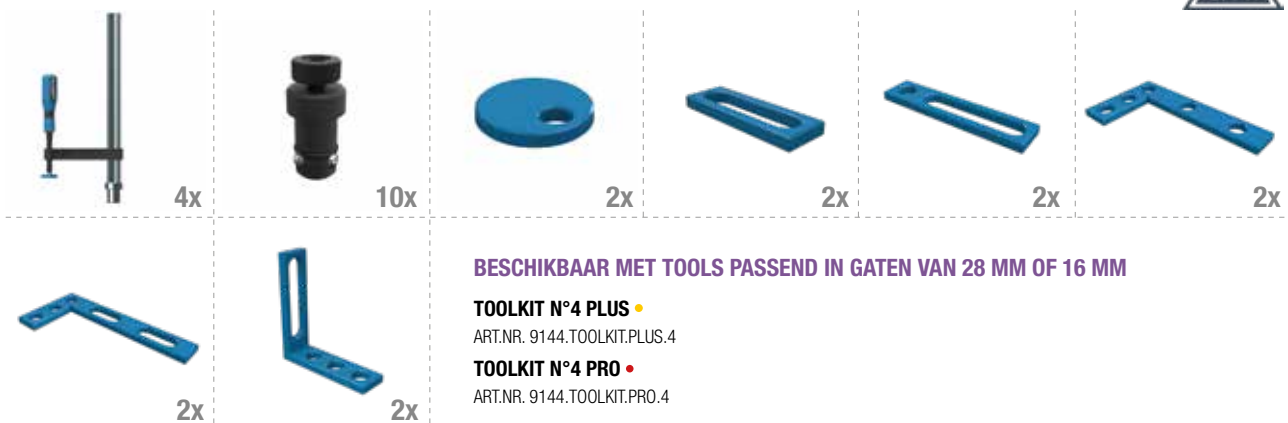

EXCLUSIEF PAKKET GPPH + PIHER

TOOLKIT N°5

77
DELIG

GPPH-TOOLS

- 8x bevestigingsklem (N.001A)
- 4x bevestigingsklem met hendel (N.001B)
- 24x snelle montagebout (N.002)
- 4x excentrische stop $\varnothing 100$ (N.003)
- 1x gradenboog (N.008)
- 2x hoek precisie vierkant (plat) 320x150 (N.010)
- 2x hoek precisie vierkant (plat) 350x250 (N.011)
- 4x hoekbeugel 185x175 (N.012)
- 1x hoekbeugel 450x250 (N.015)
- 2x prism $\varnothing 58\text{MM}$ $130^\circ/90^\circ$ (N.023)
- 1x snelle montage boutplank M (T.011B)
- 1x klemp plank M (T.011D)
- 1x gereedschapskar (T.012A)
- 4x stop 150 (N.004)
- 4x stop 225 (N.005)
- 2x hoekbeugel 200x200 (N.013)
- 2x hoekbeugel 300x190 (N.014)

PIHER-TOOLS

- 3x TCP Piston (COD.19100)
- 1x 90° steun (COD.19102)
- 1x klem voor buizen (COD.19114)
- 4x adapter 28mm (COD.19170)

+ Gratis hoekmagneet

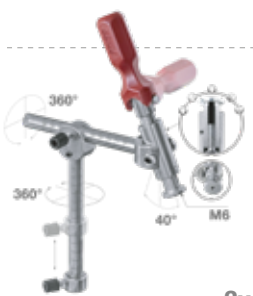

3x



1x



1x



4x

+ GRATIS
hoekmagneet

SPECIAL KIT PRO

ART. NR.: 9144.SPECIAL.KIT.PRO

SPECIAL KIT PLUS

ART. NR.: 9144.SPECIAL.KIT.PLUS

SPECIAL KIT ECO

ART. NR.: 9144.SPECIAL.KIT.ECO

BEVESTIGINGSGEREEDSCHAP

**BESSEY KLEM MET VARIABELE
UITLADING**

Art.Nr.: B.001C

**BESSEY KLEM MET HENDEL
EN VARIABELE UITLADING**

Art.Nr.: B.001D

**BESSEY
BEVESTIGINGSKLEM**

Art.Nr.: B.001E

**BESSEY BEVESTIGINGSKLEM
MET HENDEL**

Art.Nr.: B.001F

**BESSEY SCHROEFKLEM
(WERKBEREIK 200MM)**

Art.Nr.: B.001G

**BESSEY SCHROEFKLEM
(WERKBEREIK 300MM)**

Art.Nr.: B.001H

**BESSEY SCHROEFKLEM
(WERKBEREIK 600MM)**

Art.Nr.: B.001I

**BESSEY HENDEL KLEM
(WERKBEREIK 200MM)**

Art.Nr.: B.001J

**BESSEY HENDEL KLEM
(WERKBEREIK 300 MM)**

Art.Nr.: B.001K

**BESSEY HEAVY-DUTY
SCHROEFKLEM**

Art.Nr.: B.001L



**BESSEY HEAVY-DUTY
SCHROEFKLEM**

Art.Nr.: B.001M



**BESSEY HEAVY-DUTY
KLEMELEMENT
VOOR LASTAFELS**

Art.Nr.: B.001N



**BESSEY KLEMELEMENT
VOOR LASTAFELS MET
GRIJPARM**

Art.Nr.: B.0010

HOEKKLEMMEN



**BESSEY LASHOEKKLEM
(WERKBEREIK 2X90MM)**

Art.Nr.: B.024A



**BESSEY LASHOEKKLEM
(WERKBEREIK 2X120MM)**

Art.Nr.: B.024B



**BESSEY LASKLEM
SET**

Art.Nr.: B.024C

DIY LASTAFEL



EEN POLYVALENTE LASTAFEL

De DIY-lastafel van GPPH is niet alleen geschikt voor lassers, maar ook voor doe-het-zelvers, timmermannen, automonteurs enz... De unieke prijs-kwaliteitverhouding maakt van deze tafel hét perfecte instapmodel.

Er kunnen meerdere tafels aan elkaar gekoppeld worden om een groter werkoppervlak te verkrijgen. Daarnaast zijn de gereedschappen uit de GPPH PLUS-serie compatibel met de DIY-lastafels, **gecombineerd met de 16 mm doorn**. Er zijn dus heel wat mogelijkheden tot uitbreiding.

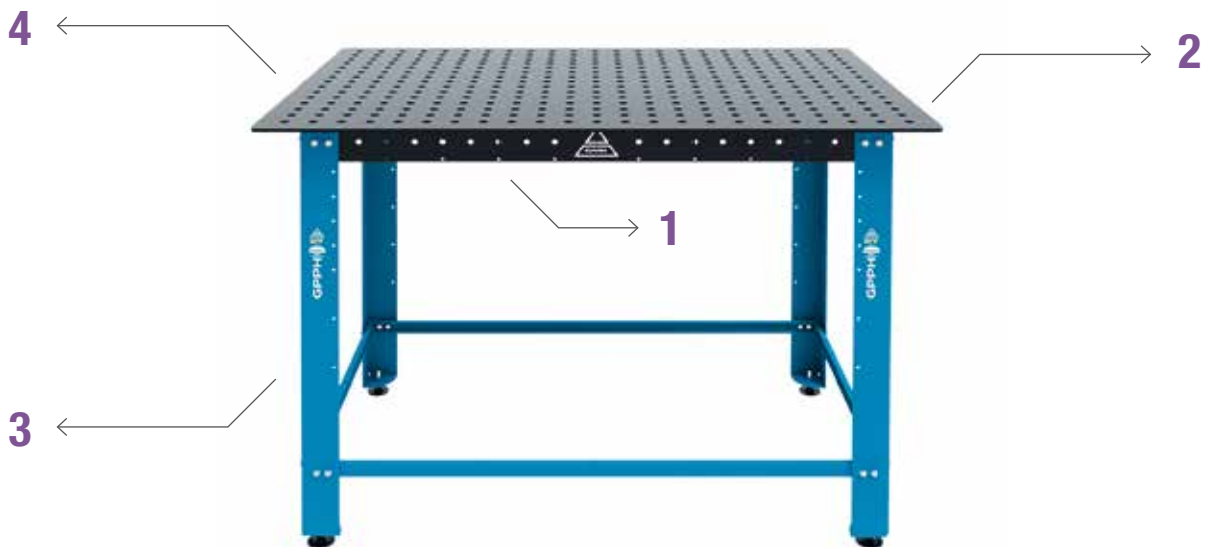

- Afmetingen: 1200x800 mm
- Metalen frame versterkt met ribben **(1)**
- Werktafel met een dikte van 8 mm, gemaakt van S355J2+N staal **(2)**
- Draaivoeten egaliseren oneffenheden **(3)**
- 16 gatensysteem in 50x50 raster **(4)**
- Gegraveerde schaalverdeling in raster van 100x100 mm

- Mogelijkheid om tafels aan elkaar te koppelen (werkopp. uitbreiden)
- ISO 2768-1 normering
- Vlakheid v.h. werkblad (+-0,5 mm/m)
- Hoogteverstelling aan de voeten
- Draagvermogen: 500 kg
- Tafelgewicht: 89 kg
- Topkwaliteit

SLIJP-LASSTATION



SLIJP-LASSTATION BASIS

Het slijp-lasstation S.P.001 is bedoeld voor het opvangen en verwijderen van stof en gassen die ontstaan bij het slijpen met een handslijpmachine of bij las- en metaalbewerkingen. Het station kan worden gebruikt met een afzuigventilator of met een door een ventilator aangedreven filterapparatuur.

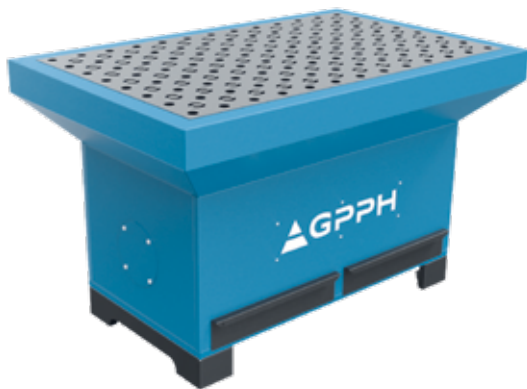

- De basis is aangepast voor de installatie van afschermingen en een top uitlaatsysteem
- Connector Ø160 mm geïnstalleerd in het zijoppervlak van de uitlaatgoot
- De lucht kan vanaf de bodem worden afgevoerd via de tafel van de afzuigtrog
- Werkblad gemaakt van 8 mm plaat met de afmetingen 1270x770 – montagegaten in het rooster 100x100 van systeem 28 en extra gaten voor de afzuiging voor stof en gassen
- Gewicht: 167 kg
- Aanbevolen luchtstroom: 3200 m³/h
- Weerstand van stroom: 250 Pa

Componenten

- Werktafel met werkblad gemaakt van een 8 mm dikke plaat
- Afzuiggoot met lades
- Twee 230 V stopcontacten voor de aansluiting van elektrisch handgereedschap
- Voorzien van aansluiting voor verlichting
- Aansluiting voor afzuiging

SLIJP-LASSTATION BASIS MET BESCHERMING

Het slijp-lasstation S.0.001 is bedoeld voor het opvangen en verwijderen van stof en gassen die ontstaan bij het slijpen met een handslijpmachine of bij las- en metaalbewerkingen. Het station kan worden gebruikt met een afzuigventilator of door een ventilator aangedreven filterapparaat.



- Werkoppervlak bescherming
- Kanteldeuren - onderdelen waarvan de lengte groter is dan de breedte van de tafel (1400 mm) kunnen op de werktafel worden geplaatst
- Connector Ø160 mm geïnstalleerd in het zijoppervlak van de uitlaatgoot
- De lucht kan vanaf de bodem worden afgevoerd via de afzuigtrog van de tafel
- Werkblad gemaakt van 8 mm plaat met de afmeting 1270x770- montagegaten in het rooster 100x100 van systeem 28 en extra gaten voor de afzuiging voor stof en gassen
- Gewicht: 190 kg
- Aanbevolen luchtstroom: 3200 m³/h
- Weerstand van stroom: 250 Pa

Componenten

- Rugplaat
- Kanteldeuren rechts en links
- Werktafel met werkblad van 8 mm plaat
- Afzuiggoot met lades
- Twee 230 V stopcontacten voor aansluiting van elektrisch handgereedschap
- Voorzien van aansluiting voor verlichting
- Aansluiting voor afzuiging

SLIJP-LASSTATION BASIS MET AFVOERELEMENT BOVENAAN

Het slijp-lasstation S.0G.001 is bedoeld voor het opvangen en verwijderen van stof en gassen die ontstaan bij het slijpen met een handslijpmachine of bij las- en metaalbewerkingen. Het station kan worden gebruikt met een afzuigventilator of door een ventilator aangedreven filterapparaat.



- Werkoppervlakbeschermers
- Top uitlaatsysteem
- Kanteldeuren - onderdelen waarvan de lengte groter is dan de breedte van de tafel (1400 mm) kunnen op de werktafel worden geplaatst
- Connector Ø160 mm geïnstalleerd in het zijoppervlak van de uitlaattrog en het bovenoppervlak van de behuizing
- De lucht kan van onderaf worden afgevoerd via de tafel van de afvoergoot en van bovenaf door de gaten in de behuizing.
- Werkblad gemaakt van 8 mm plaat met de afmetingen 1270x770 - montagegaten in het rooster 100x100 van systeem 28 en extra gaten voor de uitlaat voor stof en gassen
- LED verlichting
- Gewicht: 264 kg
- Aanbevolen luchtstroom: 3200 m³/h
- Weerstand van stroom: 250 Pa

Componenten

- Werktafel met werkblad van 8 mm plaat
- Afzuiggoot met lades
- Top uitlaatsysteem
- Kanteldeuren rechts en links
- Twee 230 V stopcontacten voor aansluiting van elektrisch handgereedschap
- Voorzien van werkverlichting

TCP-PISTONKLEM VOOR LASTAFELS

**MET BESCHERMDE SCHROEFDRAAD
350KG POWER !**

PTHER

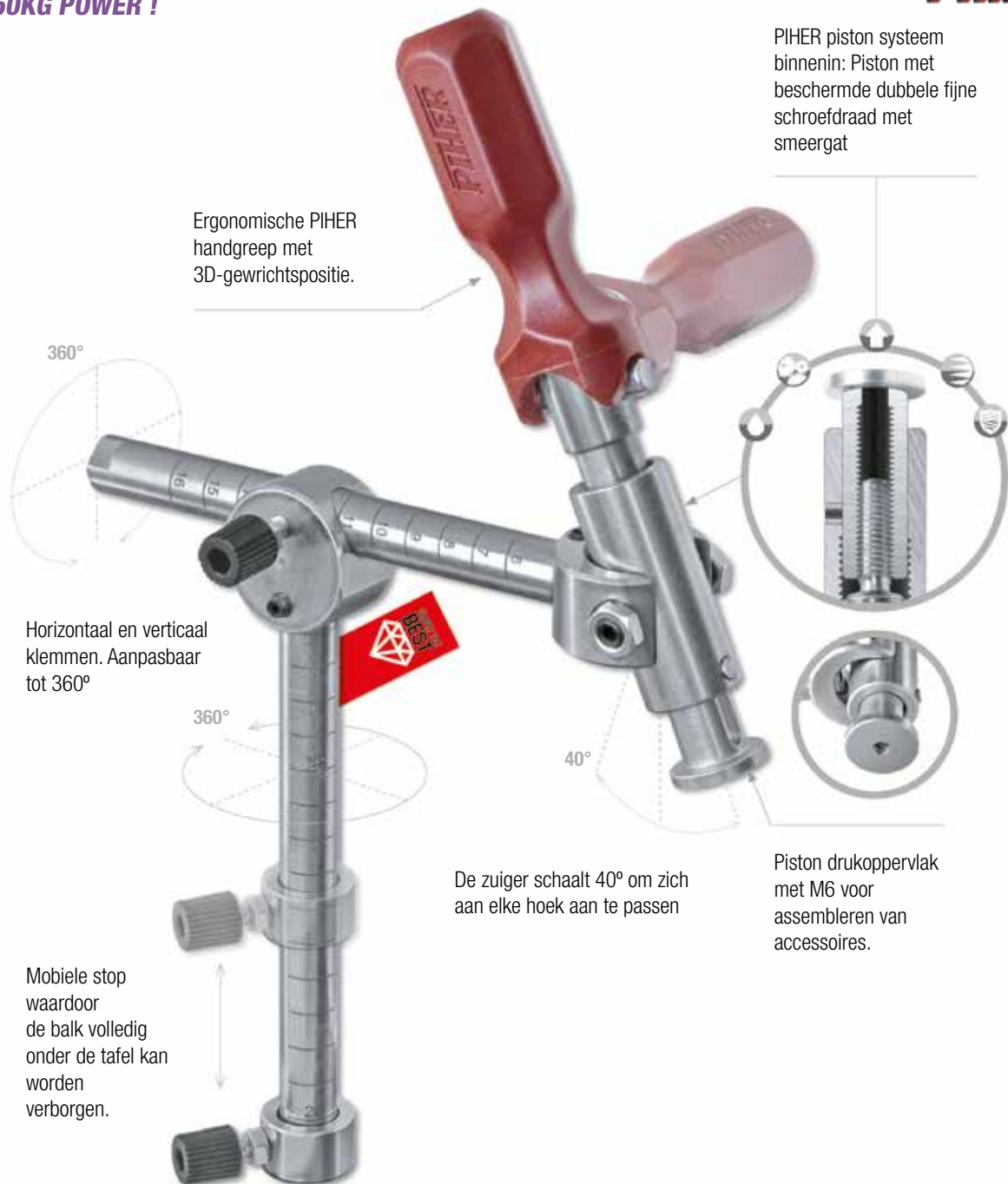

✓ Voordelen

- ✓ Piston met beschermde schroefdraad
- ✓ Verstelbare ergonomische handgreep
- ✓ Horizontaal en verticaal klemmen: aanpasbaar tot 360°
- ✓ Piston schaaft 40° om zich aan elke hoek aan te passen
- ✓ Piston drukoppervlak met M6-aansluiting
- ✓ Hoogwaardige afwerking: verzinkte as en stalen gewrichten
- ✓ Aanpasbaar aan elke hoek
- ✓ Werkt in combinatie met lastafel veel sneller en efficiënter



- PIHER piston systeem binnenin.
- Horizontaal en verticaal klemmen
- Aanpasbaar aan elke hoek
- Verzinkte as en gewrichten gemaakt uit carbonstaal
- Ergonomische handgreep, wisselbaar en inklapbaar, gemaakt uit PA met glasvezel.
- Piston drukoppervlak met M6 voor assembleren van accessoires.
- De zuiger schaaft 40° om zich aan elke hoek aan te passen.

ART.NR.	GEWICHT	VE	MAXIMUM DRUK
19100	1,24	1	350kg





ADAPTER VOOR BUIZEN + CAP

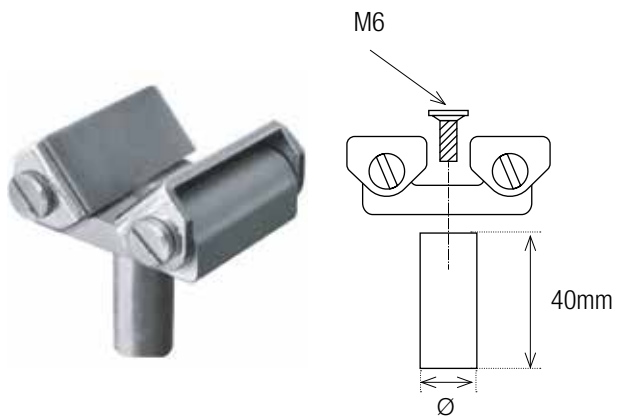

PTHER

- Verzinkt en gemaakt uit carbonstaal

ART.NR.	Ø MM	KG	VE
19111	16	0,23	1
19112	22	0,29	1
19113	28	0,36	1



ADAPTER VOOR BUIZEN

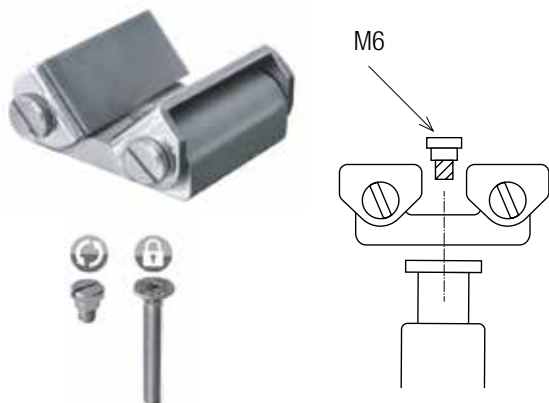

PTHER

- Accessoire kan vast of draaibaar zijn, afhankelijk van de gekozen schroef.
- Verzinkt en gemaakt uit carbonstaal

ART.NR.	KG	VE
19114	0,18	1



BAR MET M6 EN M8

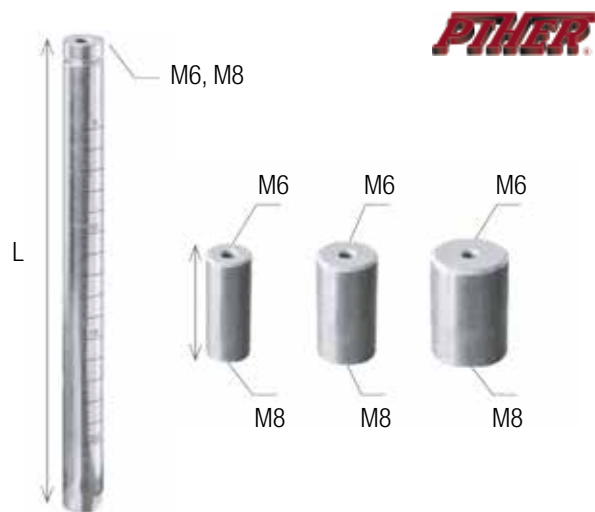

- Verzinkt en gemaakt uit carbonstaal

ART.NR.	Ø MM	L MM	KG	VE
19165	16	220	0,33	1
19166	16	40	0,05	1
19167	22	40	0,10	1
19168	28	40	0,18	1



90° ONDERSTEUNING



- Supplement voor 360° druk
- Verzinkt en gemaakt uit carbonstaal

ART.NR.	KG	VE
19102	0,53	1



LENGTESTOP

PTHER

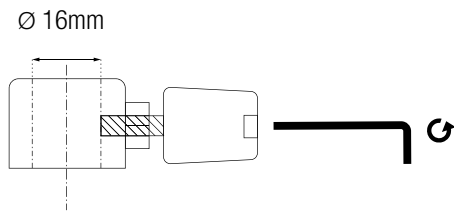

- Verzinkt en gemaakt uit carbonstaal

ART.NR.	KG	VE
19103	0,05	1

ADAPTER CAP

PTHER

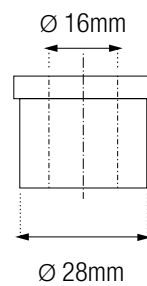
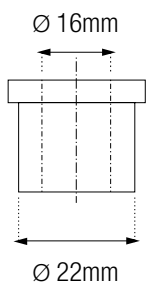

- Verzinkt en gemaakt uit carbonstaal

ART.NR.	Ø MM	KG	VE
19169	22	0,02	1
19170	28	0,06	1

MAGNETISCHE HOUDERS

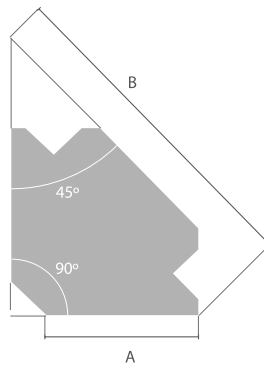

PTHER

- Voor het lassen van 45° en 90° hoeken
- Voor industrieel gebruik
- 2.5mm dik staal
- Permanent beschermde ferrietmagneet

ART.NR.	MOD	A	B	C	GEWICHT
29003	Q1	8,5cm	8,5cm	1,5cm	0,30 kg
29004	Q2	11cm	11cm	1,8cm	0,65 kg
29005	Q3	14cm	14cm	2cm	1,20 kg

GEAARDE MAGNETISCHE BLOK VOOR LASSEN



- Contact stukken geheel in de messing
- Voor industrieel gebruik
- Permanente ferrietmagneet

PTHER

ART.NR.	MOD	Ø	GEWICHT	A
29006	MG1	6cm	0,18kg	150A
29007	MG2	9cm	0,55kg	300A

TIG-INVERTERS EN MIG/MAG-LASSYSTEMEN

MW TOOLS



Vamatec levert TIG-inverters en MIG/MAG-lasystemen van MW TOOLS. Deze machines zijn ontworpen voor efficiënt en precisielassen en bieden uitstekende prestaties en bedieningsgemak.

Of je nu een professional bent of een doe-het-zelver, Vamatec heeft de juiste machine voor je lasbehoeften.

RHINO CART MOBIELE LASTAFEL

StrongHandTools



Het Rhino Cart Mobile Fixturing Station is een kant-en-klaar systeem voor opspannen en klemmen tijdens lassen en fabriceren. Klem en bevestig op elk punt op het omkeerbare, perfect vlakke en genitreeerde tafelblad (1200x750mm) voor nauwkeurigheid in al uw opstellingen.

Bestaat uit een 16 mm dik omkeerbaar tafelblad van staalplaat met genitreeerde zwarte afwerking. Plaats het opspangereedschap in de CNC-precisie geboorde gaten met een diameter van 16mm in een afstandspatroon van 50x50mm.

De stalen poten zijn uitgerust met vier vergrendelbare zwenkwielen en stelvoeten voor mobiel of stationair gebruik.

Met legborden, bakjes en een pegboardpaneel kunt u klemmen en accessoires binnen handbereik ordelijk bewaren.

TDQ612075

- Mobiele lastafel

TDQ612075-K1

- Mobiele lastafel
+ 58-delige set tools*

58

DELIG

TDQ612075-K2

- Mobiele lastafel
+ 122-delige set tools*

122

DELIG



* Meer info over de setten tools ? Contacteer ons vrijblijvend via mail: verkoop@vamatec.be of telefonisch +32 9 386 69 31

OPTIE

TPL3021

PLASMA SNIJROOSTER/SNIJTAFEL

- Ondersteunt tot 45kg
- Snijoppervlak: 450x710mm
- 14 omkeerbare / vervangbare stalen latten
- 45mm tussen snijlamellen biedt voldoende ruimte voor vastklemmen



snijrooster/
snijtafel is
inklapbaar !

OPTIE

TPLK3021

VERVANGBARE LAMELLEN SET
VOOR SNIJROOSTER/
SNIJTAFEL

OPTIE

T61825

ZIJBEUGEL



ANTI-SPAT SPRAY



ANTI-SPAT
spuitbus 400 ml

ART. NR: 111.ANTISPAT

✓ Voordelen

- Minder spatters
- Minder tijdverlies door schoonmaken
- Mooiere afwerking
- Siliconevrij
- Milieuvriendelijk

VERKRIJGBAAR PER STUK OF PER DOOS
VAN 12 SPRAYS

InterTools®
TOOLS FOR THE METAL INDUSTRY

InterTools Anti-spat is een hoogkwalitatieve spray, vervaardigd in België. Voorkomt ongewenste hechting van lasspatten op metaal oppervlakken.

E-WELD 2: LASSEN VAN DIKKE METALEN PLATEN EN MEERLAAGSE LASNADEN



E-Weld 2 is een hoogwaardige anti-spatspray op basis van natuur-identieke ingrediënten die het aanhechten van lasspatten voorkomt tijdens **MIG / MAG- lassen en laser- of plasmasnijden**.

WAARVOOR E-WELD 2 GEBRUIKEN ?

- > Voor het lassen van: staal, RVS en aluminium
- > E-Weld 2 is vooral geschikt voor het lassen van dikke platen en meerlaagse lasnaden



BIO-CIRCLE®



Een dunne film fungeert als een barrière tussen het werkstuk en het hete metaal. De uitstekende bevochtiging van het oppervlak beschermt het werkstuk en de uitrusting. **Het lossingsmiddel beschermt echter ook in gedroogde toestand, is gebruiksklaar, behoeft geen etikettering en biedt veiligheid voor gebruiker en milieu.**

✓ Voordelen

- ✓ Opeenvolgende bewerkingen zijn probleemloos mogelijk: siliconen- en olie vrij
- ✓ Voor het lassen van staal, RVS en aluminium
- ✓ Tussentijdse opslag mogelijk: tijdelijke corrosiebescherming
- ✓ Veilig in gebruik: VOC- en labelvrij
- ✓ Oplosmiddel- en siliconenvrij
- ✓ Geurloos
- ✓ Zeer goed bevochtigend vermogen: een dunne laag heeft een uitstekend lossend vermogen
- ✓ Vergemakkelijkt probleemloos verzinken en vernissen na het lassen
- ✓ Geen etikettering vereist volgens de CLP-verordening
- ✓ Zeer zuinig
- ✓ Goede bescherming tegen corrosie

ART.NR.	CODE	OMSCHRIJVING	FORMAAT
1012.EWELD.2.500ML	D50002	BIO-CIRCLE E-WELD 2 SPRAY	500ML
1012.EWELD.2.10L	D01002	BIO-CIRCLE E-WELD 2 JERRYCAN	10L
1012.EWELD.2.20L	D02002	BIO-CIRCLE E-WELD 2 JERRYCAN	20L

E-WELD 3: LASBESCHERMINGSSPRAY MET REINIGENDE WERKING



De geurloze, op water gebaseerde antispat spray met reinigende en ontvettende werking kan worden gebruikt voor alle gangbare lastoepassingen van **MIG / MAG-lassen tot lasersnijden**. De eenvoudig aan te brengen emulsie verhindert de aanhechting van lasspatten in zowel natte als droge toestand en beschermt werkstukken, lasmondstukken en lasaccessoires tijdens het bewerkingsproces.



WAARVOOR E-WELD 3 GEBRUIKEN?

- > Voor het lassen van: staal en RVS
 - > Vervuilingen zoals spanen, machineoliën, lichte corrosie-werende oliën of koelvloeistoffen van zaagmachines kunnen vóór het lasproces eenvoudig en effectief worden verwijderd met E-Weld 3
- Op het schone oppervlak kan direct worden gelast !



De ingrediënten vormen een barrière tussen het werkstuk en de spatten en bieden tijdelijke corrosiebescherming voor alle lasbare metalen. **De metalen platen kunnen direct na het lasproces eenvoudig verzinkt of gelakt worden.**



Bij lasersnijden biedt E-Weld 3 het voordeel dat de vorming van slak op het injectiepunt van de laser wordt vermeden en dat roet gemakkelijker kan worden verwijderd.

Een nabewerking van de snijkanten is niet nodig.

✓ Voordelen

- ✓ Veelzijdig: vuil kan worden verwijderd met E-Weld 3
- ✓ Voor het lassen van staal en RVS
- ✓ Opeenvolgende bewerkingen zijn probleemloos mogelijk: siliconen- en olievrij
- ✓ Veilig in gebruik: VOC- en labelvrij
- ✓ Nabewerking snijkanten bij lasersnijden niet nodig

ART.NR.	CODE	OMSCHRIJVING	FORMAAT
1012.EWELD.3.500ML	D50008	BIO-CIRCLE E-WELD 3 SPRAY	500ML
1012.EWELD.3.10L	D01008	BIO-CIRCLE E-WELD 3 JERRYCAN	10L
1012.EWELD.3.20L	D02008	BIO-CIRCLE E-WELD 3 JERRYCAN	20L

E-WELD 4: OPTIMAAL LASSEN DANKZIJ HET MOSES-EFFECT



E-Weld 4 is een lasbeschermingsspray op waterbasis op basis van hernieuwbare grondstoffen. Natuurlijke koolzaadcomponenten voorkomen dat lasspatten zich hechten aan oppervlakken zoals metaal, gereedschap, apparaten of lasmondstukken. Tijd- en arbeidsintensieve verwijdering van lasspatten wordt overbodig; **ook hoog-energetische spatten blijven niet plakken.**



WAARVOOR E-WELD 4 GEBRUIKEN?

- > Voor het lassen van: staal, RVS en aluminium
- > Nauwkeurig werken, ook bij moeilijke, fijne lasnaden, omdat het **Moses-effect** ervoor zorgt dat het lasscheidingsmiddel zich bij verhitte verspreidt

E-Weld 4 voorkomt dat lasspatten blijven plakken tijdens MIG / MAG- lassen en laser- of plasmasnijden



E-Weld 4 is vrij van oplosmiddelen, minerale oliën en siliconen. Nabewerkingsprocessen worden dus niet nadelig beïnvloed. **Verzinken en lakken na het lassen is mogelijk zonder problemen.** Tijdens het lassen zijn er geen nare geurtjes of rookoverlast.

✓ Voordelen

- ✓ Optimaal lasresultaat: lassen zonder poriënvorming
- ✓ Opeenvolgende bewerkingen zijn probleemloos mogelijk: siliconen- en olievrij
- ✓ Voor het lassen van staal, RVS en aluminium
- ✓ Tussentijdse opslag mogelijk: tijdelijke corrosiebescherming
- ✓ Beschermt gereedschappen, metalen, apparaten en mondstukken tegen lasspatten
- ✓ Klaar voor gebruik en reukloos
- ✓ Op basis van waterige, natuurlijke koolzaadcomponenten
- ✓ Zonder siliconen
- ✓ Effectief in droge en natte toestand
- ✓ Veilig in gebruik: VOC- en labelvrij

ART.NR.	CODE	OMSCHRIJVING	FORMAAT
1012.EWELD.4.500ML	D50012	BIO-CIRCLE E-WELD 4 SPRAY	500ML
1012.EWELD.4.10L	D01012	BIO-CIRCLE E-WELD 4 JERRYCAN	10L
1012.EWELD.4.20L	D02012	BIO-CIRCLE E-WELD 4 JERRYCAN	20L

E-WELD SHIELD: VOOR LASER- OF PLASMASNIJMACHINE



WAARVOOR E-WELD SHIELD GEBRUIKEN?

- > Ter bescherming van uw laser-of plasmasnijmachine
- > Ter preventie afzetting van "slak" tijdens plasma/lasersnijden

Bio-Circle E-Weld Shield voorkomt afzetting van de "slak" die tijdens het plasma- en lasersnijden ontstaat op de lamel. Deze bescherming geeft een langere levensduur van de lamel en een betere uptime van uw machine

Door deze keramische bescherming is uw snijtafel altijd in perfecte staat. De onderhoudsfrequentie zal worden beperkt tot een minimum en het onderhouden van de lamellen verloopt veel gemakkelijker en sneller aangezien de slak zich minder vasthecht.



✓ Voordelen

- ✓ Snelle en eenvoudige reiniging
- ✓ 3x langere levensduur van de lamellen
- ✓ Betere up-time van de machine

ART.NR.	CODE	OMSCHRIJVING	FORMAAT
1012.EWELD.SHIELD.10	D01116	BIO-CIRCLE E-WELD SHIELD JERRYCAN	10 KG

GREEN-CUT MIDDEL VOOR PLASMASNIJDEN

MIDDEL VOOR PLASMASNIJDEN

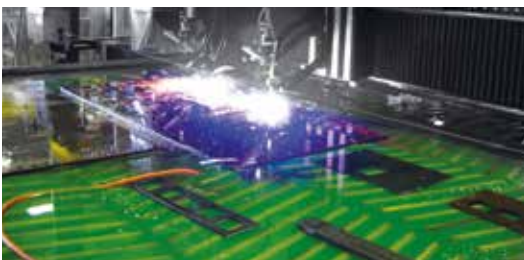

✓ Voordelen

- ✓ Milieuvriendelijk
- ✓ Veilig
- ✓ Verhoogt productiviteit



- 20 Liter
- ART.NR. 1007.GP7

TOEPASSINGEN

CNC plasmasnijden

MATERIALEN

Koolstofstaal, roestvrij staal, messing, inconel, titanium, aluminium

PRESTATIES

- Plasmatafelkoelvloeistof speciaal ontworpen voor CNC-plasmasnijden
- Voorkomt corrosie, bacteriën en hotspotting
- Wordt thermisch niet minder: er zijn geen wijzigingen nodig
- Bevat antiroest-, antischuim- en antibacteriële additieven
- Superieure oppervlakteafwerking en verhoogde productiesnelheden
- 100% effectief ongeacht de snelheid
- GreenCut® Plasma is een in water oplosbaar pakket, gemengd met water in een verhouding van 20:1
- Gemakkelijk afspoelbaar met water; laat geen sporen na
- Geen carterreinigingen nodig gedurende ten minste één jaar met correct onderhoud en pompcirculatie

LASPASTA - WELD DYN



- Anti-spat pasta
- Creëert een beschermende film op het mondstuk en voorkomt het aanheven van lasspatten
- Het blik is magnetisch en laat toe het mondstuk te dippen zonder te verschuiven

✓ Voordelen

- ✓ verlengt levensduur toorts en onderdelen
- ✓ Magnetisch blik
- ✓ Handig in gebruik

Inhoud: 200g

MIG-LASTOORTSHOUDERS



De in hoogte en hoek verstelbare ReadyRests kunnen stevig op elk stalen oppervlak worden bevestigd, zodat u uw toorts en kabel veilig en gemakkelijk kunt vasthouden en volledige toegang hebt terwijl u werkt. De unieke verstelbare kabelhanger biedt kabelcontrole voor veiligheid en gebruiksgemak.

Bewaar je toorts op de ReadyRest om schade te voorkomen en een schone, georganiseerde werkruimte te creëren.

⚠ **OPGELET: ENKEL VOOR GEBRUIK BIJ HECHTLASSEN ***

MRM100



- Hoogte: 152mm
- Gewicht: 0,95kg

- MIG-toortshouder met kabelhanger en accessoire plaat
- Magnetische voet
- 2x houder voor tang
- Haakse anti-spat gelpot

MRM200



- Hoogte: 178 - 305mm
- Gewicht: 1,6kg

- MIG-toortshouder met kabelhanger en accessoire plaat
- Magnetische voet
- 2x houder voor tang
- Haakse anti-spat gelpot
- **Verstelbare hoogte**

MINI-MAGNETEN

StrongHandTools

MS346AT



MS350A

- Met een hoogte van slechts 59 mm bieden minimagneten een laag profiel voor het vasthouden van je materiaal op krappe en moeilijk bereikbare plaatsen
- Gebruik zoveel magneten als nodig
- Perfect voor gebruik in de werkplaats en compact genoeg om mee te nemen voor gebruik op de werf

! **OPGELET: ENKEL VOOR GEBRUIK BIJ HECHTLASSEN ***

ART.NR.	HOEKEN	MAX.TREKKRACHT	AFM. (MM)	GEWICHT
MS346AT (tweelingpakket)	30°, 60°, 45°, 90°	10 kg	59 x 50 x 16	0,3 kg
MS346AK (6-pack)	30°, 60°, 45°, 90°	10 kg	59 x 50 x 16	0,8 kg
MS350A	30°, 60°, 45°, 90°	13,6 kg	86 x 75 x 16	0,3 kg

MINI-MAGNETEN

StrongHandTools

MS45 / 45°-90°



MS60 / 60°-90°



MS346 / Multi-angle

Houdt het werkstuk onder meerdere hoeken vast tijdens het solderen, hardsolderen en lassen op 30°, 45°, 60° en 90°.

! **OPGELET: ENKEL VOOR GEBRUIK BIJ HECHTLASSEN ***

ART.NR.	HOEKEN	MAX.TREKKRACHT	AFM. (MM)	GEWICHT
MS45	45°, 90°	10 kg	113 x 98 x 19	0,3 kg
MS60	60°, 90°	25 kg	113 x 98 x 19	0,5kg
MS346C	30°, 60°, 45°, 90°	40 kg	113 x 98 x 23	0,8 kg

ADJUST-O-HOEKMAGNETEN

StrongHandTools

MET HANDIGE ON / OFF SCHAKELAAR !

- Zet de magneet **uit** of in het midden tijdens het opzetten, zet **aan** als je klaar bent om te werken
- Snelle en veilige installatie!
- Makkelijk schoon te maken. Zet gewoon **Off** en veeg schoon

De snelle en gemakkelijke manier om metalen werkstukken vast te houden op 30°/60°, 45° en 90°.

Ideaal voor ronde en vierkante buizen, hoekige en platte buizen.

! OPGELET: ENKEL VOOR GEBRUIK BIJ HECHTLASSEN *

ART.NR.	MAX.TREKKRACHT	AFM. (MM)	GEWICHT
MSA45	30 kg	111 x 95 x 25	0,5 kg
MSA46-HD	40 kg	111 x 95 x 29	0,7 kg
MSA47	35 kg	152 x 130 x 32	1,0 kg
MSA48-HD	75 kg	152 x 130 x 35	1,4 kg
MSA53-HD	65 kg	152 x 130 x 35	1,4 kg

OPTIE

MXE13 3^{DE} AS VOETJES

- Voor snelle setup werkstukken met 3 assen
- Kan op beide zijden van de magneet gebruikt worden

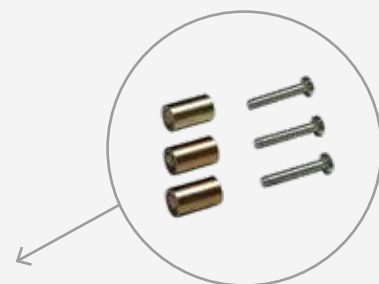

ADJUST-O-HOEKMAGNETEN MET DUBBELE SCHAKELAAR



MET DUBBELE ON / OFF SCHAKELAAR !

- 2x on/off schakelaars voor onafhankelijke bediening
- Zet de magneten **uit** bij het opzetten, zet **aan** als je klaar bent om te werken. Eenvoudige en veilige installatie !

Voor professionele klussen die sterke neer-houdkrachten vereisen. Houdt platte en ronde metalen werkstukken vast.

Precisie gefreesde platte en V-oppervlakken zijn ideaal voor ronde en vierkante buizen, hoekige en platte materialen.

Kies uit 55-120kg trekkkracht.

! OPGELET: ENKEL VOOR GEBRUIK BIJ HECHTLASSEN *



ART.NR.	MAX.TREKKRACHT	AFM. (MM)	GEWICHT
MS2-80	55 kg	152 x 152 x 38	1,2 kg
MS2-90	120 kg	197 x 197 x 48	2,7 kg

ADJUST-O-HOEKMAGNETEN - REGELBAAR



REGELBAAR VAN 30° T.E.M 275° ÉN DUBBELE SCHAKELAAR !

- Instelbaar van 30°-275°
- 2x on/off schakelaars

V-groefoppervlakken houden ronde en vierkante buizen, hoekige en platte materialen stevig vast.

Precisie gefreesde vlakke oppervlakken en nikkel / chroom body.

! OPGELET: ENKEL VOOR GEBRUIK BIJ HECHTLASSEN *



ART.NR.	MAX.TREKKRACHT	AFM. (MM)	GEWICHT
MAV120	50 kg	197 x 197 x 95	2,4 kg

HOEKMAGNETEN 90°

StrongHandTools

- Creëer hoeken van 90° door vanaf de buitenkant vast te houden, zodat u een onbelemmerd gebied krijgt voor hechtlassen aan de binnenkant.
- Een zijhoek reliëf biedt ruimte voor de hoge lippen.
- Gebruik de buitenranden van de Corner Magnet om materialen op 60° op te zetten.

! OPGELET: ENKEL VOOR GEBRUIK BIJ HECHTLASSEN *



Gebruik de buitenranden van de Corner Magnet om de hoek op 120° te houden.



Gebruik de buitenste randen van de hoekmagneet om de hoek op 60° te houden.



De compacte en onopvallende hoekmagneet is ideaal voor het licht vasthouden van hoek op 90°.



De compacte en onopvallende hoekmagneet is ideaal voor het licht vasthouden van hoek op 90°.

ART.NR.	OMSCHRIJVING	MAX.TREKKRACHT	AFM. (MM)	GEWICHT
MST327	Set van 2 stuks	14 kg	83 x 95 x 16	0,4 kg

BINNEN / BUITEN HOEKMAGNETEN

StrongHandTools

- Houdt en positioneert plaatwerk, ronde buizen, vierkante, gehoekte of platte buizen.
- De binnen / buitenhoekmagneten zijn gemaakt van 2 onafhankelijke rechthoekige magneten voor een consistente en onverminderde magnetische kracht wanneer beide zijden aan werkstukken zijn bevestigd.
- Gebruik montagegaten om 2 magneten aan elkaar te koppelen voor gebruik als bevestigingselementen.

! OPGELET: ENKEL VOOR GEBRUIK BIJ HECHTLASSEN *



Verstelbare hoek



Pin om te blokkeren op 45°



Aftrekhefboom



Hoek vergrendelen

ART.NR.	OMSCHRIJVING	HOEKEN	H X B X DIKTE (MM)	TREKKRACHT	GEWICHT
MLDT350	Vaste hoek. Combinatiepakket: 1x MLD300 + 1x MLD 500	-	-	-	0,5 kg
MLD300	(Verkocht als onderdeel van combo MLDT350)	90° (30°, 60°)	75,5 x 52 x 14	9 kg max.	-
MLD500	(Verkocht als onderdeel van combo MLDT350)	90° (30°, 60°)	125 x 85 x 18	15 kg max.	-
MLD600	Vaste hoek	90° (30°, 60°)	165 x 110 x 20	18 kg max.	0,8 kg
MLA450	Instelbaar	30-270°	120 x 120 x 18	12 kg max.	0,5 kg
MLA600	Instelbaar	30-270°	156 x 156 x 20	15 kg max.	0,9 kg

MIG-TANG

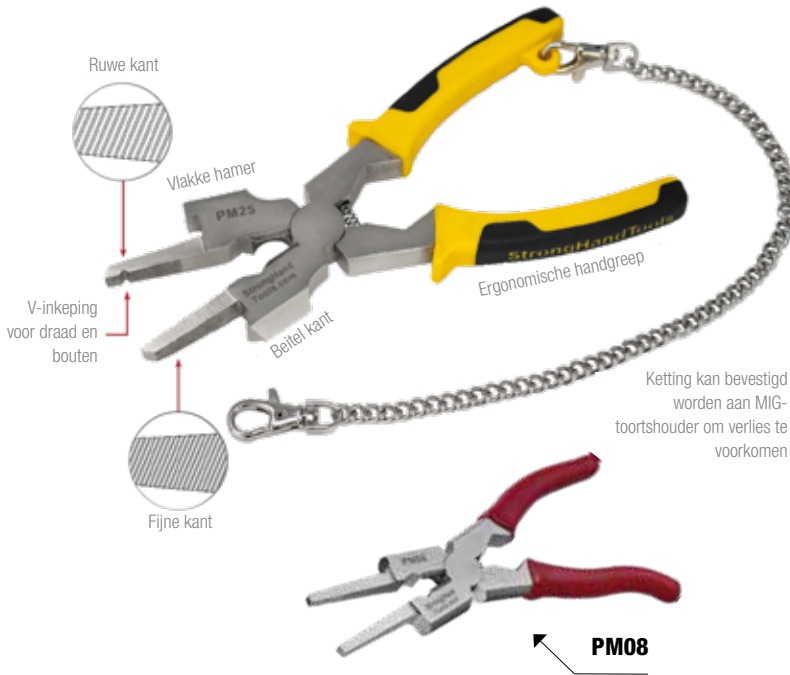

PM12

PM08

- Beitelzijde voor het verwijderen van slak en restanten die overblijven na het lassen
- Platte hamer met schraperrand voor snelle verwijdering van spatten
- Inductie geharde snijkant, versnipperrand en schraperrand
- Fijne en grove vijlneus voor het schrapen van de binnenkant van het gasmondstuk
- Ergonomische comfortgreep met retentieketting
- Knippen lasdraad
- Verwijderen gasmondstuk
- Losdraaien contacttip

ART.NR.	OMSCHRIJVING	LENGTE (MM)	GEWICHT
PM12	Luxe uitvoering met beitelkant, platte hamer, fijne en grove vijlneus, v-inkeping voor draad en bouten, ketting, ergonomische handgreep.	215	0,4 kg
PM08	Standaard Model	215	0,3 kg

GASCILINDER KLEM



Het verplaatsen van een gascilinder dient uiteraard met de nodige voorzichtigheid te gebeuren. Veiligheid primeert op de werkvloer. De gascilinder klem laat toe de gasfles op een stabiele en veilige manier te verplaatsen.



- De klem is voorzien van 2 handvaten, zo kan u op een veilige manier met 2 personen de cilinder verplaatsen.
- De klem heeft 8 contactpunten (met frictiekussens). Dit zorgt voor een stevige en veilige grip.
- Het schaarsysteem zorgt ervoor dat de gascilinder direct vastgeklemd wordt bij het hanteren van de handvaten. Wanneer de handvaten losgelaten worden blijft de klem z'n positie behouden.

Art. Nr.: 9152.GCL230

GASCILINDER TRANSPORTWAGEN

StrongHandTools

De nieuwe cilinderwagen van Strong Hand Tools is speciaal ontworpen om gascilinders eenvoudig te verplaatsen en op te heffen. Zo kan u de gascilinders gemakkelijker transporteren en plaatsen naar een hoger gelegen platform zoals bv. een laswagen of pallet.



- Eenvoudig gascilinders verplaatsen, ook naar een hoger gelegen platform (t.e.m. 175mm hoogte)
- RVS klem zorgt ervoor dat de cilinder mooi op z'n plaats blijft tijdens het vervoeren van de gasfles
- V-vormige frictiepunten voor extra stabiliteit
- Voorzien van een veiligheidsbalk
- 4-wielen voor optimale stabiliteit. De 2 achterste (draaibare wielen) zorgen voor comfortabele bewegingsvrijheid + kunnen vastgezet worden voor eenvoudig stockage.
- Groot ergonomisch handvat.
- Capaciteit 180kg

Art. Nr.: 9152.GCC210

