

EISENBLÄTTER

Simply better ideas.



SURFACE TECHNOLOGIES FOR SPECIALISTS

EISENBLÄTTER GRINDING TOOLS

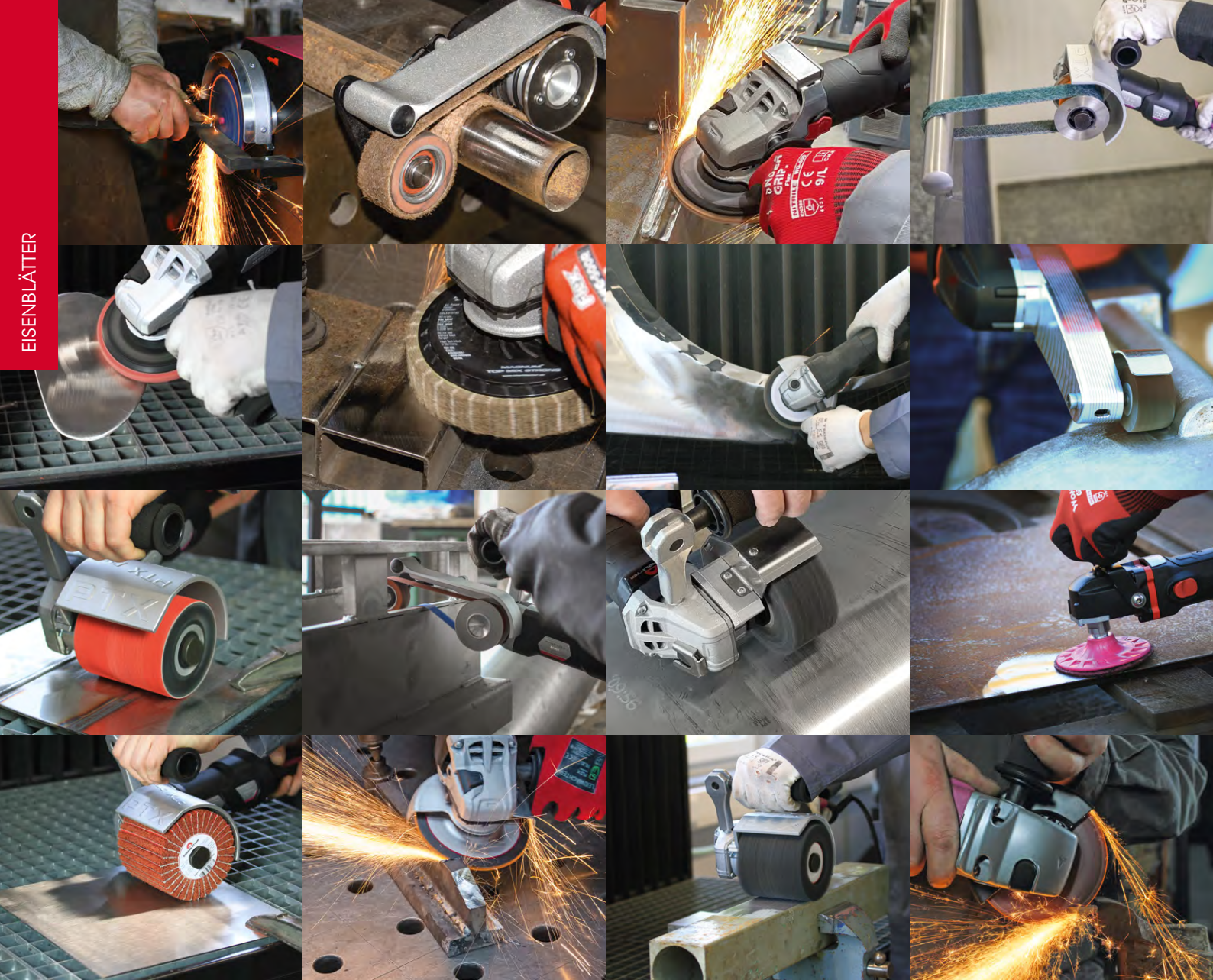

HOW TO CONTACT US

Via phone:

Switchboard	(+49) 8171 9082 – 010
Sales department	(+49) 8171 9082 – 020
Purchasing department	(+49) 8171 9082 – 050
Accounts department	(+49) 8171 9082 – 060

Via fax:

Switchboard	(+49) 8171 9082 – 210
Sales department	(+49) 8171 9082 – 220
Purchasing department	(+49) 8171 9082 – 250
Accounts department	(+49) 8171 9082 – 260

Office and Administration:

Gerd Eisenblätter GmbH
 Jeschkenstraße 12d
 82538 Geretsried
 Germany

Delivery:

Gerd Eisenblätter GmbH
 Keplerweg 4
 82538 Geretsried
 Germany

info@eisenblaetter.de
 www.eisenblaetter.de

Eisenblätter Demo Centre

Koblenzer Str. 29a
 56656 Brohl-Lützing
 Germany
 Phone (+49) 2633 2000 982
 Fax (+49) 2633 2000 983
 demo@eisenblaetter.de

www.eisenblaetter.de/en

Pictures may differ from the original. Technical changes and errors reserved.



Quality from our own production for over 50 years

For more than 50 years, Eisenblätter has been producing new, **sophisticated techniques for the surface treatment** of stainless steel and non-ferrous metals. Creating highly decorative surfaces with the least amount of effort is our guiding principle. Many well-known companies worldwide have been using the wealth of experience and often superior techniques for decades. **Over 80 patents** and intellectual **property rights** protect Eisenblätter's unique know-how, true to the motto **"Simply better ideas"**. Many of today's established tools for surface treatment originated at Eisenblätter. Such as the hand-held linear grinding machine with accessories, or zirconium flap discs for high-speed angle grinders, to name just a few. Eisenblätter has received a number of state awards and business awards over the years.



Company tour 2008: Visit of Minister Ilse Aigner and member of the German Parliament Dagmar Wöhl.

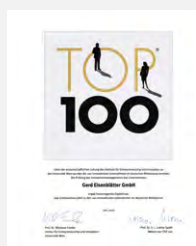

2021 Top Innovation in Surface Technologies
50 YEARS

Certified quality

DIN ISO certification according to the latest standards

Eisenblätter GmbH – inventor and innovation driver of many grinding techniques known today – was successfully certified in 2020 according to the latest DIN ISO 9001:2015.

This certification in quality management guarantees our customers verifiable and consistent top quality of our high-tech products manufactured in Germany.

Product safety, user friendliness and environmental friendliness have been top priorities at Eisenblätter for decades!

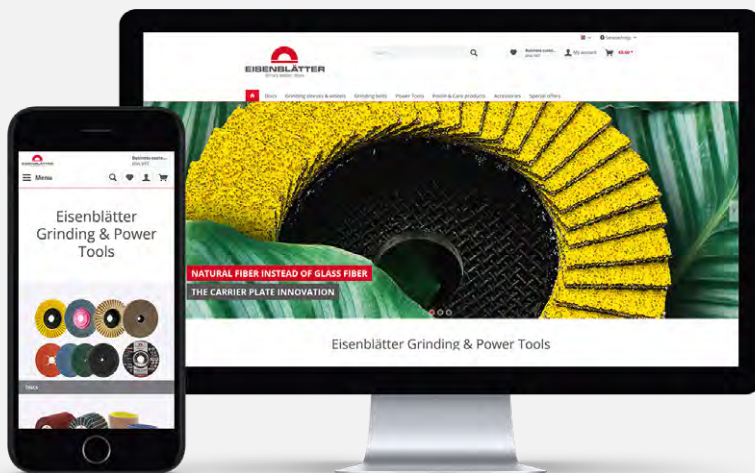

Shop online

Test the new Eisenblätter online shop!

All information about our products, as well as new products and additional user videos are available at www.eisenblaetter.de/shop/en

Stay up to date.

Subscribe to our newsletter and follow us on YouTube, LinkedIn and Facebook.



Facebook



LinkedIn



YouTube



Eisenblätter comes to you!

Make an appointment now:

Eisenblätter Demo Centre

Phone (+49) 2633 2000 982 · demo@eisenblaetter.de
Koblenzer Str. 29a · 56656 Brohl-Lützing · Germany

Eisenblätter icon key



Natural fibre
Backing plate consists primarily of regenerative natural fibres



Flexible
Flexible material



Flexible
Flexible backing material



Copyrighted design
Design or product feature is under copyright



Patented
Patented



Patent pending
Patent pending



Approved for
Only suitable for cutting at a 90° angle

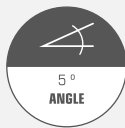

5° angle of incidence
Tool support at a 5° angle



Approved for
Suitable for rough and side grinding



Free of fibre glass
Free of fibre glass components



M14 integrated
Integrated M14 threads



Plus backing pad
To be used only with a suitable backing pad



Reducing noise
Noise level reduced under load



Flat contact surface area
Flat tool support



Trimable
Trimmable tool backing plate



Balanced
Unique wheel balancing to ensure that the wheel runs perfectly



Accessories
Accessory items



Material: All metals
To be used on all metals



Material: Aluminum
To be used on aluminum



Material: NF metals
To be used on non-ferrous metals



Material: Stainless steel
To be used on stainless steel



Material: Wood
To be used on wood



Material: Steel
To be used on steel



Material: Hard plastics
To be used on hard plastics



HighTorque

New motor with extremely high torque



Suitable for ceramic flap discs



MPA tested
Tested by the Material Prüfanstalt testing authority

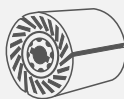

Expansion roller
Only to be used with a POLY-PTX® expansion roller

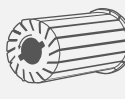

Eco Smart Adapter
Only to be used with the POLY-PTX® Eco Smart adapter



Guaranteed free of rust
Registered trademark of Focus Rostfrei

Eisenblätter innovations at a glance

VARILEX® 1100
angle grinder



page 14

VARILEX® AKKU
BRUSHLESS
angle grinder



page 20

TOPRAIL 1100 HT
pipe belt sander



page 174

MINI MAX® 1100
multifunctional
grinder



page 90

BAND-IT 1100
power file



page 182

ROLEI EF 115
PROFESSIONAL
facetting device



page 202

Grinder Grip™
magnet machine
holder



page 22

ROHR MAX®
finger protection
cover



page 189

Particulate matter
protection cap



page 232

**MAGNUM®
PRECICUT
cutting discs**



page 28

**TRIMFIX®
MUSTANG®
flap disc**

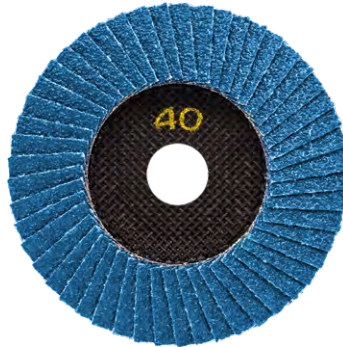

page 36

**COLDSTEEL®
RazorFlap®
grinding disc**



page 56

**PTX COMPACT HT linear grinder and
tools with M14 thread**

PTX COMPACT HT p.116



Expansion roller p.120



Grinding belt roller p.120



Stainless steel grinding wheel mount p.118



Flap wheel p.121



Fleece wheel p.122



Clean wheel p.123



Mix wheel p.121



Felt wheel p.122

from page 116

18 VOLTS

300 POWER TOOLS

30 MANUFACTURERS

ONE BATTERY,

MANY SOLUTIONS



Discover wireless battery freedom – with these Eisenblätter CAS power tools!

Discover cordless freedom! Take advantage of 100% compatibility of machines, battery packs, and chargers in a cross-manufacturer system! **CAS makes the most powerful battery system in the industry from Metabo and more than 30 years of battery competence available for Eisenblätter machines as well.** What's in it for you? Highest levels of reliability, clear cost benefits, and great investment security. **Cordless Alliance System (CAS)** is an association of leading power tool brands. This makes a number of professional applications from a wide variety of machine manufacturers available with the same battery system for the first time – from standard to special jobs.

More power

with the new LiHD cell technology in conjunction with a newly developed battery pack

- Larger contacts and busbars capable of carrying high currents
- A cell connector made of a special copper delivers three times the conductivity

More charge

- More active material in the cell
- High-quality materials (silver and copper) used

More service life and extreme robustness

- Complete compound and protective lacquer on the electronics and optimum seal in the cover design ensure ideal protection from internal contamination
- Rubber puffer protects the cells
- More usable energy means charging less often
- Exterior rubber battery pack coating ensures safe, non-slip positioning and serves as impact protection

VARILEX® AKKU BRUSHLESS



page 20

VARILEX® POLISHER AKKU



page 62

MINI MAX® AKKU



page 92

POLY-PTX® AKKU HT



page 128

ROHR MAX® AKKU



page 178

BAND-IT AKKU



page 184

100% up-to-date: You can find all information about CAS at www.cordless-alliance-system.com. Since the number of machines is constantly growing, you can also download the **latest list of CAS-compatible devices** here.



Chapter overview

Angular grinding – circular grinding

page 12

VARILEX® angle grinders p. 14



Flap discs p. 33



Cutting & rough grinding discs p. 28



Fibre discs p. 56

VARILEX® angle polishers p. 60



Cleaning discs p. 74



FIX HOOK & LOOP system p. 81



Fine grinding discs p. 65



Polishing discs p. 78

Multifunctional grinding

page 89

MINI MAX® multifunctional grinders p. 90



MINI MAX® grinding wheels p. 98



MINI MAX® grinding sleeves p. 97

MINI MAX® polishing tips p. 100

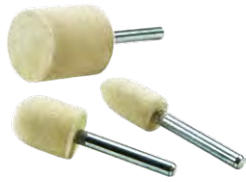

MINI FIX HOOK & LOOP system p. 102



Flexible shaft p. 94



MINI MAX® technical brushes p. 101

PINLOC system p. 107

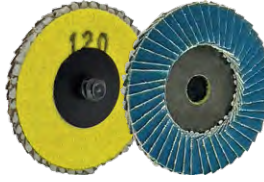

Linear grinding – satin finishing

page 114

PTX COMPACT linear grinders p. 116



POLY-PTX® grinding wheels p. 135



POLY-PTX® linear grinders p. 124

POLY-PTX® grinding sleeves p. 153



POLY-PTX® pipe processing p. 165

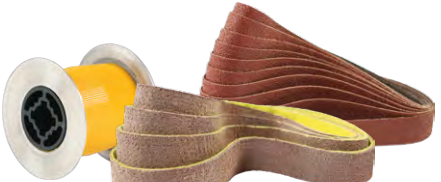

POLY-PTX® technical brushes p. 151



Eco Smart p. 160



Chapter overview

Belt grinding

page 171

Belt sanders p. 174



Grinding belts p. 193

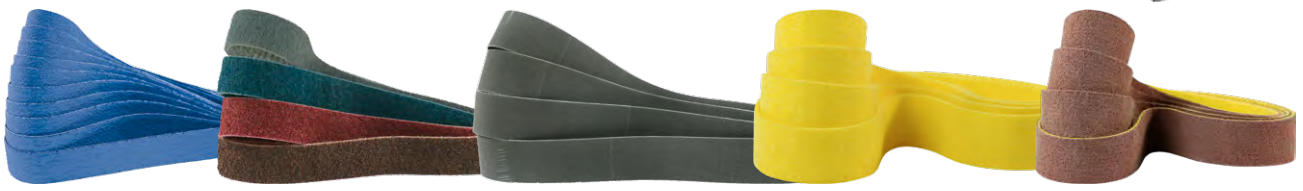

Deburring and bevelling

page 201

ROLEI deburring and bevelling devices p. 202



Care products

page 214

BRIGHTEX® polishing system p. 215



Polishing p. 218

Chemicals & care products p. 219



Test sets p. 224

Accessories

page 225

Tool cases p. 226



Stainless steel cover plate p. 228

CAS battery accessories p. 229



Dust protection p. 232



Ball joint mount p. 231

ANGULAR GRINDING - CIRCULAR GRINDING

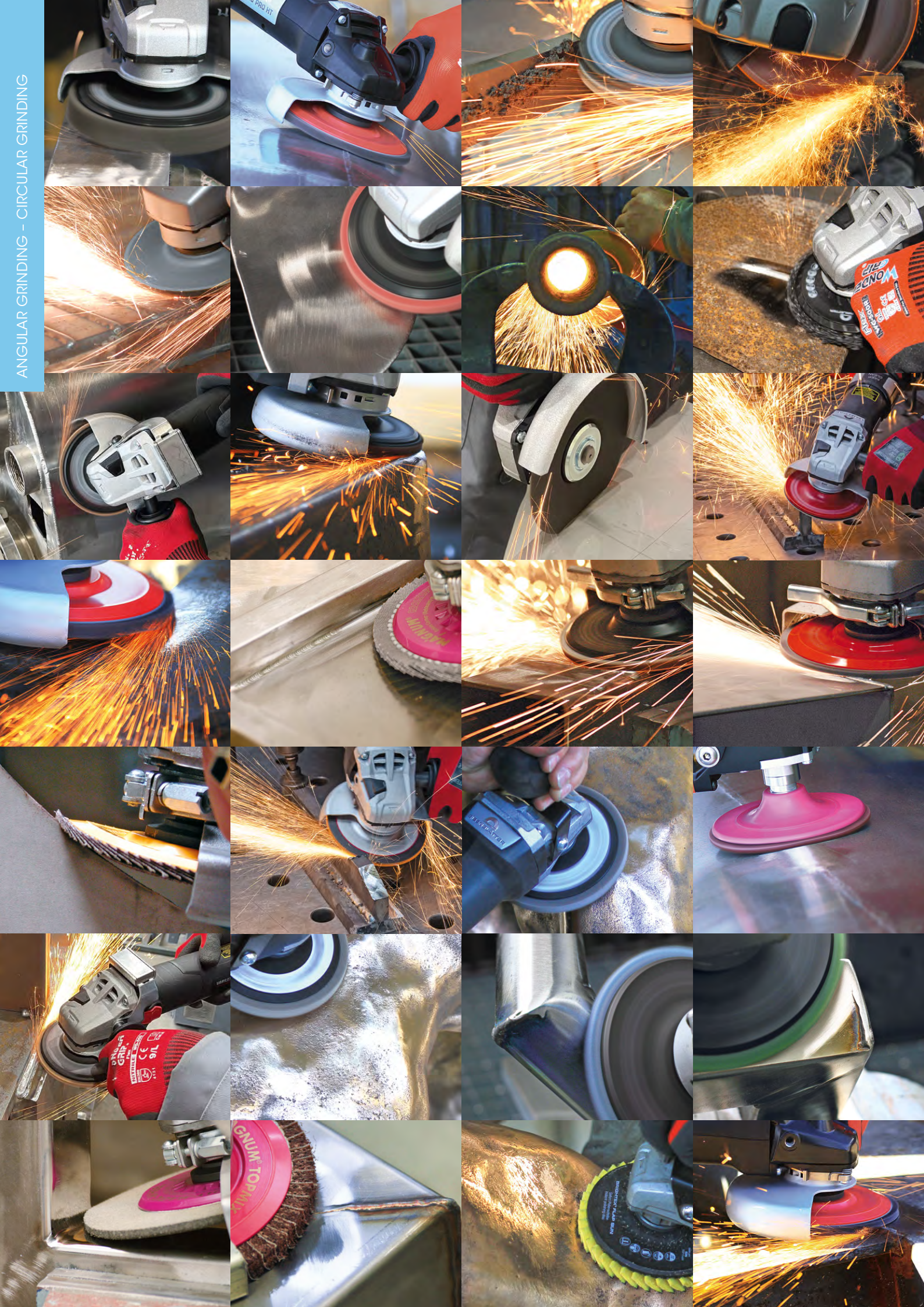

ANGULAR GRINDING – CIRCULAR GRINDING

VARILEX® ANGLE GRINDERS	14	VARILEX® ANGLE POLISHERS	60
NEW VARILEX® 1100.....	14	VARILEX® POLISHER HT.....	60
VARILEX® 1802 HT.....	16	VARILEX® POLISHER AKKU	62
VARILEX® 1800	18	Accessory set	64
NEW VARILEX® AKKU BRUSHLESS	20		
Accessories	22	FINE GRINDING DISCS	65
Accessory sets.....	26	MAGNUM® Poly Magic Wheel	65
		MAGNUM® DecoFinish.....	66
CUTTING AND ROUGH GRINDING DISC	28	TRIMFIX® Fleece Flap 1FOR2	68
NEW MAGNUM® PRECICUT.....	28	TRIMFIX® Fleece Flap	69
MAGNUM® RAZORCUT®	30	MAGNUM® Fleece Top	70
MAGNUM® FINECUT.....	31	MAGNUM® Top Mix	72
MAGNUM® TWINFLEX®	31	MAGNUM® Top Mix Strong.....	73
MAGNUM® FLEXO	32		
		CLEANING DISCS	74
FLAP DISCS	33	MAGNUM® CLEAN-MIX.....	74
NEW TRIMFIX® MUSTANG®	36	MAGNUM® CLEAN-PLUS.....	75
TRIMFIX® HellFire®	38	MAGNUM® STAINLESS-CLEAN	76
TRIMFIX® SteelFire®	40	CLEAN disc MCD	77
TRIMFIX® BLACK MAMBA®	42		
TRIMFIX® ZIRCOPUR®	44	POLISHING DISCS	78
PLANTEX® Cool Top® Universal	46	BRIGHTEX® FLAP Berry & Sun.....	78
MAGNUM® Cool Top® 5+	48	BRIGHTEX® FLAP test set	80
MAGNUM® Kehlnaht	50		
MAGNUM® Ceramic.....	51	FIX HOOK & LOOP SYSTEM	81
BLUE SHARK® Elastic	52	FIX HOOK & LOOP special backing pad	81
TIGER SHARK® Elastic flap disc.....	53	FIX HOOK & LOOP Cool Top® flap disc	82
ZIRCOTEX® Nylon Plan flap disc.....	54	FIX HOOK & LOOP zircon disc.....	83
Flap disc test box.....	55	FIX HOOK & LOOP CLEAN disc	83
		FIX HOOK & LOOP AluPolish disc	84
FIBRE DISCS	56	FIX HOOK & LOOP SC fleece disc	85
NEW COLDSTEEL® RazorFlap®	56	FIX HOOK & LOOP Trizact™ discs.....	86
COLDSTEEL®	58	FIX HOOK & LOOP BRIGHTEX® Berry & Sun discs ...	87
COLDSTEEL® backing pad	59	FIX HOOK & LOOP SuperPolish disc	88
		FIX HOOK & LOOP felt disc.....	88

VARILEX® ANGLE GRINDERS

Mains powered machines

SUITABLE FOR ROUGH GRINDING TO POLISHING

VARILEX® 1100 compact angle grinder

The compact power house:
grinding – fine sanding – cutting – roughing

Eisenblätter is now introducing a new, particularly handy compact angle grinder with **1,100 watts of power consumption, variable speed** and new technical features.

A **robust slip clutch** is integrated in the device, which prevents a possible jamming of the panes. This means that you can work particularly safely with **VARILEX® 1100**.

The constant electronics ensure infinitely **variable speeds between 2,800 and 9,600 rpm**. The VARILEX® 1100 is **ideal for one- and two-hand work**.

Grinding is particularly universal and allows – taking into account the speed ranges – a large number of **different surface treatments**.

NEW



Note:

Particularly difficult **“heavy-duty work”** should naturally be carried out with the **VARILEX® 1802 HT angle grinder** (1,800 watts) and a larger physical torque.

The new, particularly robust **VARILEX® 1100** is the **ideal device for medium-heavy work**.

Benefits at a glance

- **New, compact generation of angle grinders** with the smallest handle circumference in its performance class **for fatigue-free grinding in perfect ergonomics**.
- **“Marathon-Engine”** offers **30% higher power reserves** with up to **50% more torque** compared to comparable devices.
- **Maximum service life** thanks to the new, internal dust protection seal and external **particulate matter protection cap with exchangeable filter**.
- **Ideal speed range for flap discs** up to Ø 125 mm.
- **Full-wave electronics offer constant speeds** of exclusive **2,800 to 9,600 rpm**, ideal for a wide variety of processing tools such as flap discs, cutting discs and fine grinding discs.
- Protective hood adjustable without tools, can be fixed in place so that it cannot be turned.
- **Mechanical safety clutch** minimizes “kick-back” when blocking a disc for **maximum user protection** and quick resumption of work.
- **Electronic overload protection, soft start and restart protection**.
- Maintenance-friendly device design – for **carbon brush replacement in seconds**.
- **Switch-off carbon brushes** to protect the motor.
- **Foam rubber handle** for “soft”, vibration-neutral grinding.
- **Made in Germany**.



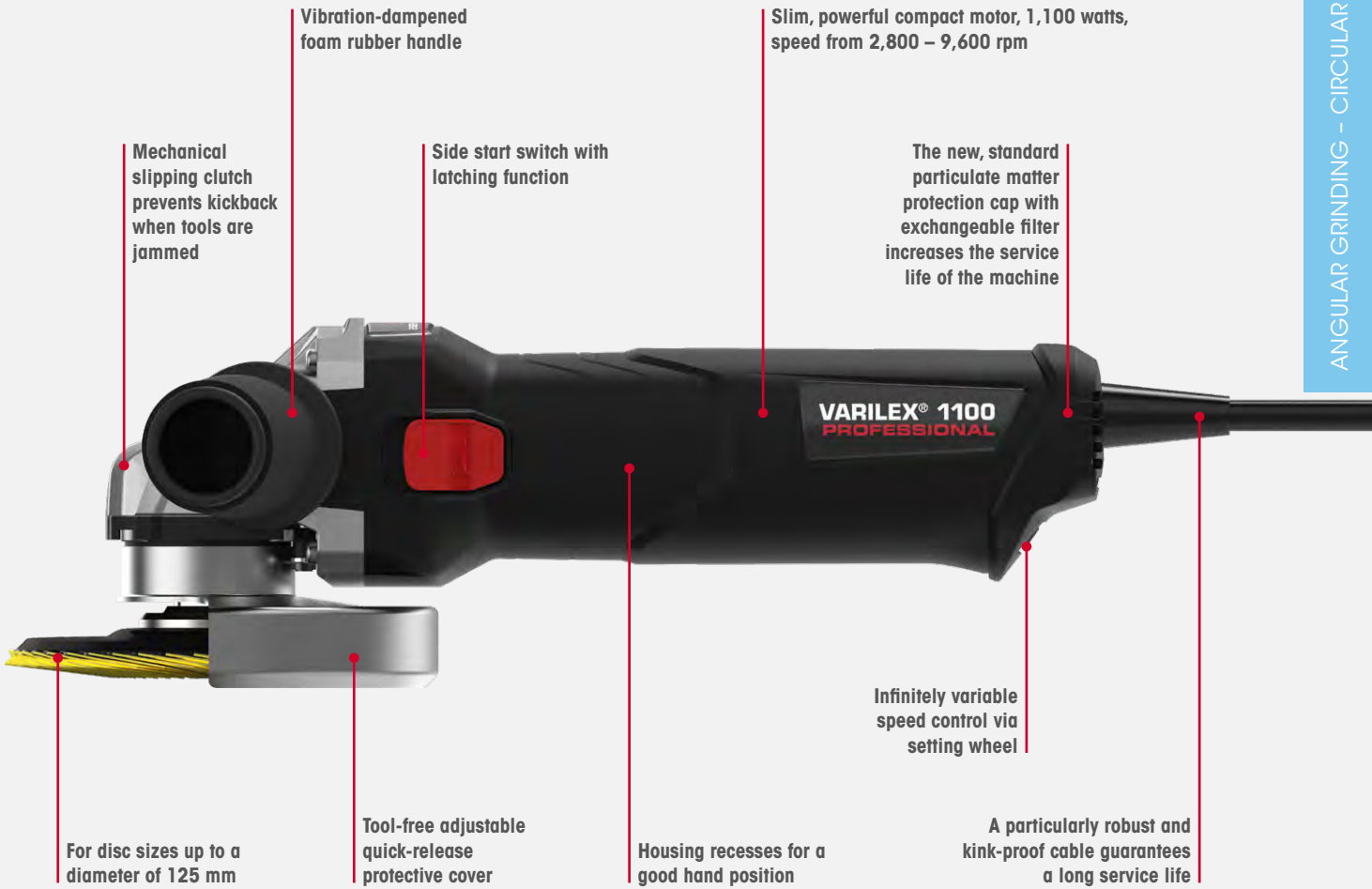

Technical specifications VARILEX® 1100 compact angle grinder

Plug type	Cable type	Mains connection (V ~ Hz)	Power (W)	Mount	Speed (rpm)	Weight (kg)	Discs up to (Ø mm)	Pkg. unit 	Article number
EU (C+F)	Permanent connection	220 – 240 ~ 50 – 60	1,100	M14 thread	2,800 – 9,600	2.1	125	1	65400

- Contents:**
- 1 VARILEX® 1100 compact angle grinder
 - 1 Robust, impact-resistant plastic case
 - 1 Particulate matter protection cap
 - 1 Protective cover up to Ø 125 mm
 - 1 Cut-off wheel cover clip up to Ø 125 mm
 - 1 Clamping nut
 - 1 Chuck key
 - 1 High-performance flap disc Ø 125 mm
 - 1 Premium cutting disc Ø 125 x 1,0 mm

Please note: Practical accessory sets from page 26.

The new, standard particulate matter protection cap with exchangeable filter increases the service life of the machine!



Optional: The new Grinder Grip™ magnet machine holder. Easier. Safer. Practical. (see page 22)



Also available as a CAS cordless machine: VARILEX® AKKU BRUSHLESS (see page 20)



VARILEX® ANGLE GRINDERS

Mains powered machines

SUITABLE FOR ROUGH GRINDING TO POLISHING

VARILEX® 1802 HT

The torque miracle

Since the “ceramic age” of flap discs or fibre, cutting and grinding discs, the performance requirements for hand-held electrical devices (e.g. angle grinders, etc.) have increased enormously. In the long run, most devices can no longer withstand this additional load of friction and contact pressure.

Eisenblätter has taken on this challenge by further developing its ceramic flap discs and further developing its **speed-controlled angle grinder** under the brand name VARILEX®.

The new VARILEX® 1802 HT (High Torque) model now meets all the performance requirements for state-of-the-art ceramic grinding wheels of all kinds.



Benefits at a glance

- **Extremely powerful and durable motor with 1,750 watts** and optimised, wear-resistant power transmission and mechanics. With new ventilation technology for an unprecedented high torque (High Torque), **100% made in Germany**.
- Newly developed, particularly **ergonomic long handle** allows you to work without getting tired – with a total weight of just 2.6 kg and rubberised inserts for better grip.
- **The speed range of 2,400 – 8,900 rpm, which is particularly optimized for ceramic grinding wheels**, can be set variably and constantly using a tachometer generator for maximum efficiency.
- **Lightweight 2.6 kg.**
- Spindle lock with robust, mechanical slipping clutch. Prevents kickback when clamping the tool.
- **Ideal angle grinder for all surface treatments:** grinding, cutting, roughing, cleaning and polishing, **for disc sizes from 115 – 150 mm in diameter.**
- Balanced, vibration-dampened gear handle. Optional: **vibration-damped rubber ball handle** ensures balanced handling, even when working overhead.
- Also **ideal as a stationary drive motor** for optional **flexible shafts** (M14 thread) or as a stationary motor for attachment to work tables with the optionally available, robust ball joint bracket.



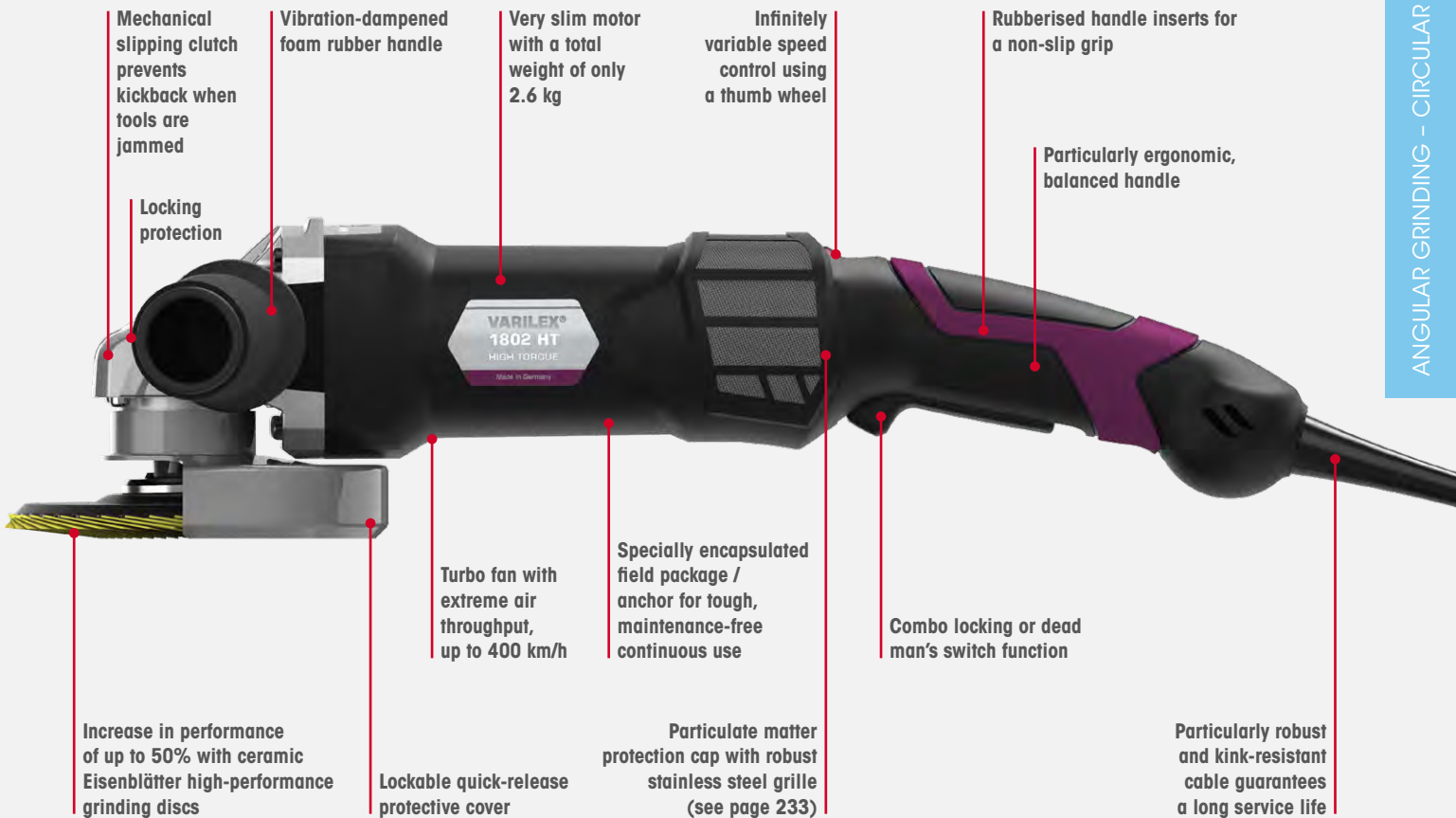

Technical specifications VARILEX® 1802 HT basic set

Plug type	Cable type	Mains connection (V ~ Hz)	Power (W)	Mount	Speed (rpm)	Weight (kg)	Discs up to (Ø mm)	Pkg. unit 	Article number
EU (C+F)	Permanent connection	220 – 240 ~ 50 – 60	1,750	M14 thread	2,400 – 8,900	2.6	150	1	65031
GB (G)	Permanent connection	110 – 120 ~ 50 – 60	1,750	M14 thread	2,400 – 8,900	2.6	150	1	65031a

- Contents:**
- 1 VARILEX® 1802 HT basic device
 - 1 Robust, impact-resistant plastic case
 - 1 Particulate matter protection cap
 - 1 Protective cover up to Ø 125 mm
 - 1 Cut-off wheel cover clip up to Ø 125 mm
 - 1 Clamping nut
 - 1 Chuck key
 - 10 High-performance flap discs Ø 125 mm
 - 10 Premium cutting discs Ø 125 x 1,0 mm

Please note: Practical accessory set see page 26.



Optional: The soft rubber ball handle (page 24) enables fatigue-free sanding in any working position without assuming an unnatural and strenuous hand position. This also makes overhead work child's play.



Also available as a CAS cordless machine.
VARILEX® AKKU BRUSHLESS (see page 20)



Optional: Ball joint holder (see page 231) for stationary attachment to work tables etc.

VARILEX® ANGLE GRINDERS

Mains powered machines

SUITABLE FOR ROUGH GRINDING TO POLISHING

VARILEX® 1800

Powerful one-hand angle grinder

The powerful angle grinder VARILEX® 1800, which has been tried and tested for many years, impresses with 1,750 watts of power and speed control for demanding continuous use with high torque in the medium speed range.

The compact and balanced design ensures optimal hand guidance when working on metal surfaces.

The sophisticated fine dust protection with exchangeable filter grids significantly extends the service life of the machine.



Benefits at a glance

- **Ideal drive for high-performance discs** such as TRIMFIX® HellFire®, TRIMFIX® BLACK MAMBA® and MAGNUM® Cool Top®: optimal exploitation of the performance potential and ideal for working with grinding and cutting discs.
- Excellent for cleaning, **fine grinding and polishing of stainless steel and non-ferrous metals**, for the FIX HOOK & LOOP system and with adapter for the MINI FIX HOOK & LOOP system.
- **Infinitely variable speed from 2,000 rpm to 7,600 rpm with tachometer generator** for constant speed even under load.
- **Powerful one-hand angle grinder** – suitable for disc sizes from 115 to 150 mm.
- **Balanced and vibration-dampened gear handle** for fatigue-free work.
- **Rubberised, particularly ergonomic handle** enables excellent hand control and sensitivity when working.
- As a **drive motor for flexible shafts** (M14 thread).
- **Particularly smooth running.**



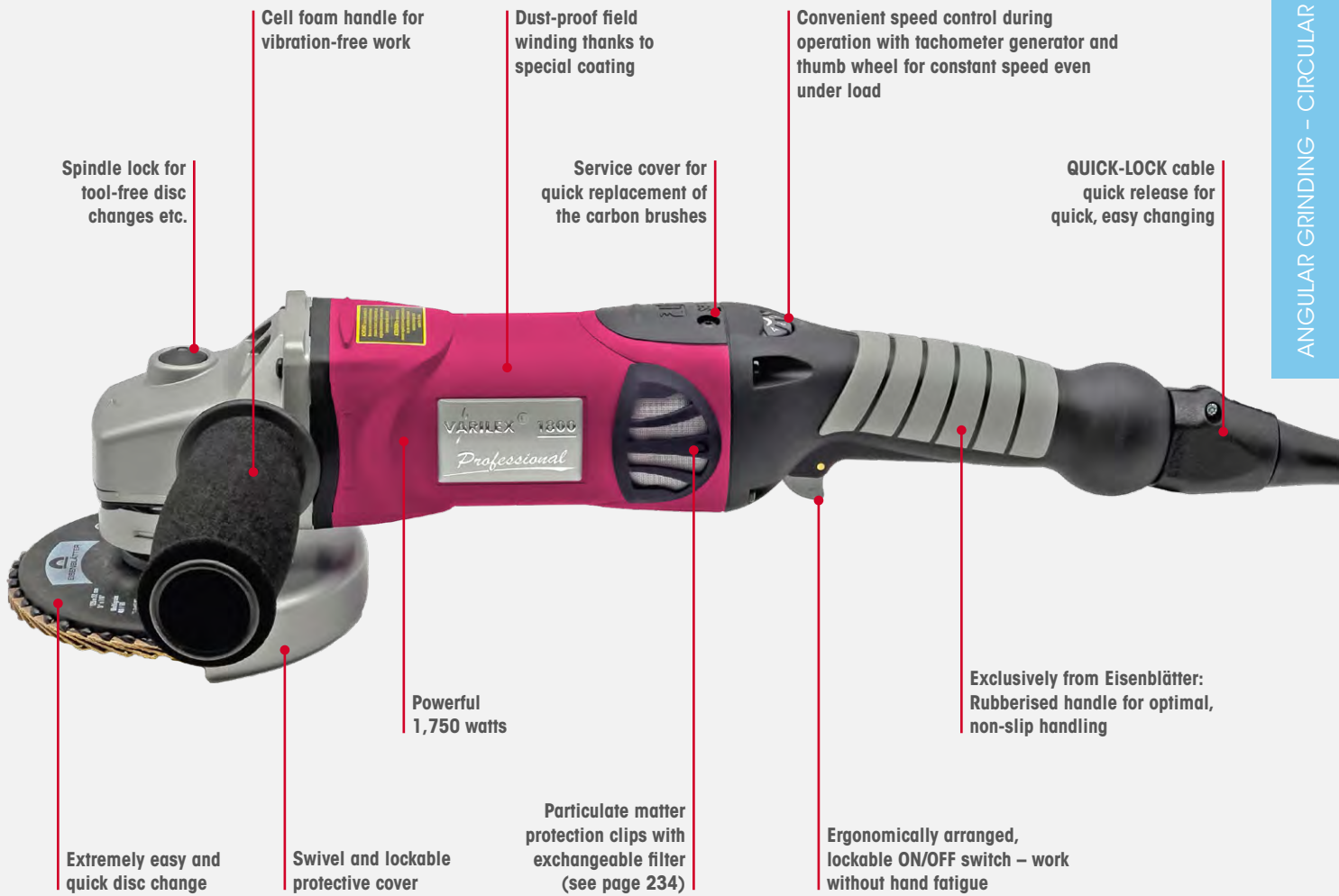

Technical specifications VARILEX® 1800 basic device

Plug type	Cable type	Mains connection (V ~ Hz)	Power (W)	Mount	Speed (rpm)	Weight (kg)	Discs up to (Ø mm)	Pkg. unit	Article number
EU (C+F)	QUICK-LOCK	220 – 240 ~ 50-60	1,750	M14 thread	2,000 – 7,600	2.8	150	1	65000

- Scope of delivery:**
- 1 VARILEX® 1800 basic device
 - 1 QUICK-LOCK cable 4 m
 - 1 Particulate matter protection clip
 - 1 Protective cover up to Ø 125 mm
 - 1 Clamping nut
 - 1 Chuck key
 - 1 Flap disc Ø 125 mm

Optional: The new Grinder Grip™ magnet machine holder. Easier. Safer. Practical.
(see page 22)



The ideal addition to your machine: VARILEX® accessory sets (from page 26)



The fine dust protection clip with exchangeable filter prevents fine dust and dirt particles from penetrating the interior of the machine (see page 234).

VARILEX® ANGLE GRINDERS

CAS cordless machines

SUITABLE FOR ROUGH GRINDING TO POLISHING

VARILEX® AKKU BRUSHLESS

High pulling power

The new benchmark among “brushless” cordless angle grinders.

With the **VARILEX® AKKU BRUSHLESS**, Eisenblätter presents the **latest generation** of “brushless”, battery-powered angle grinders. A **pulling power (high torque)** like power-connected angle grinders of approx. 1,200 watts, thanks to an **exclusive speed range of 2,000 – 7,600 rpm** (gear-generated). This makes the new VARILEX® AKKU BRUSHLESS the ideal companion with up to **40% more power** for professional work with **flap, cutting and grinding discs**. Thanks to the **constant speed control**, other **elastic grinding systems** can also be used, such as **fleece and cleaning discs** or **HOOK & LOOP systems (velcro) and much more**. This makes the new grinder extremely **versatile on assembly and construction sites**. Thanks to the **new ergonomics and equipment**, the new VARILEX® AKKU BRUSHLESS grinder is extremely **handy and well-balanced** and can therefore also be used for longer **work cycles without tiring**. Due to the encapsulated, brushless motor, **regular maintenance work** (carbon change) **can now be omitted**. An additional **dust filter** protects the electronics.



Benefits at a glance

- **Extremely powerful, brushless and encapsulated 18 volt high-tech special motor, up to 40% more power** than previous models.
- **High-performance batteries of the latest generation with LiHD technology, safety electronics and 5.5 Ah, optionally 8.0 Ah**, can be rotated in 3 locking stages on the device (ideal for narrow grinding areas).
- **High performance fast charger.**
- **CAS battery compatible interface** – “1 battery for many brand manufacturers”, see page 8.
- **New housing ergonomics** for fatigue-free work, **balanced and rubberised**.
- **Constant speed control from 2,000 – 7,600 rpm, gear generated** for high torque.
- **Rapid braking system** for maximum occupational safety.
- **Replaceable dust protection filter.**
- **Handle foam rubber.**
- Protective hoods with a **diameter of up to 125 mm** that can be locked and rotated multiple times.
- **Extremely versatile** for use with a wide range of abrasive types.
- **Made in Germany.**



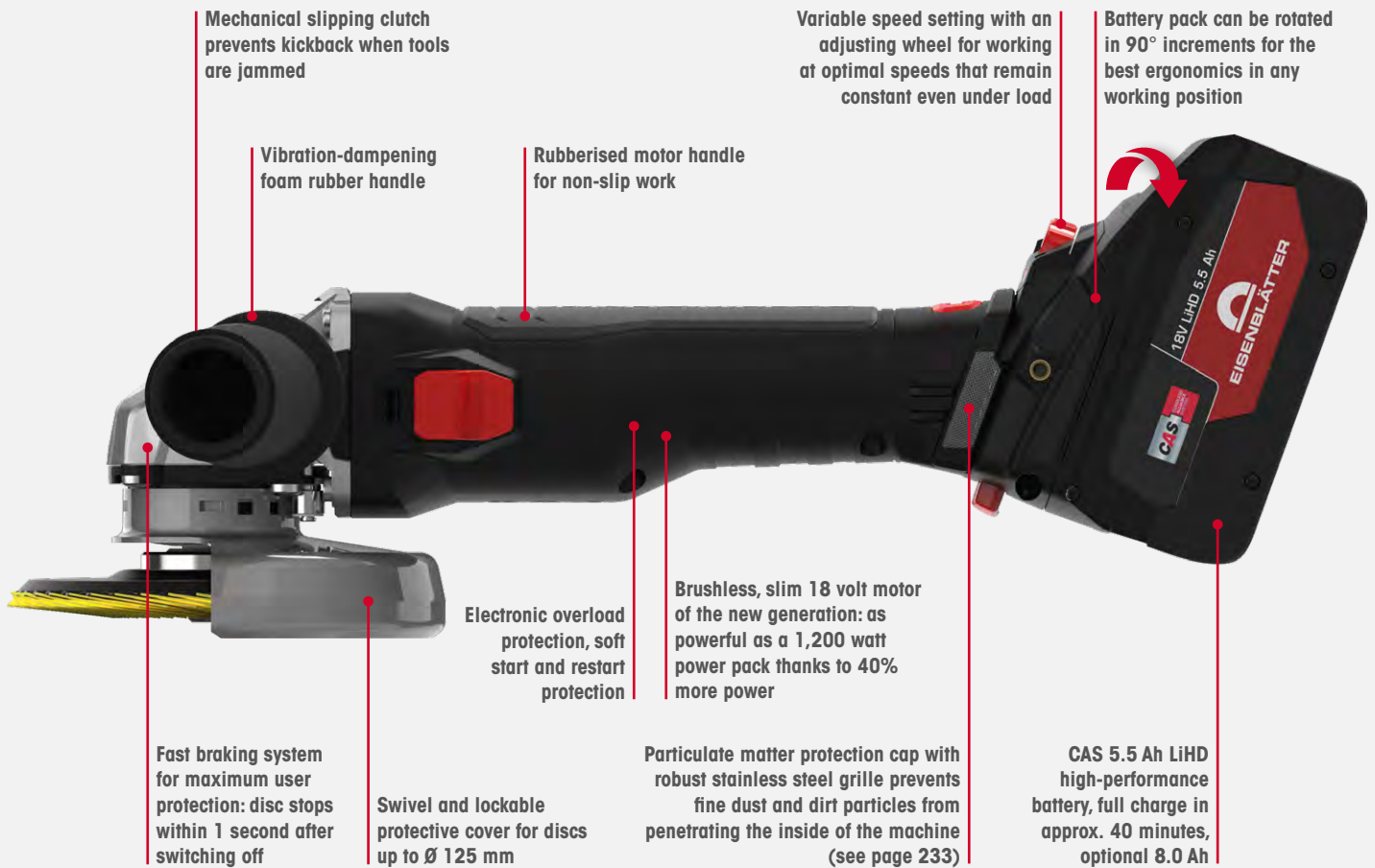

Technical specifications VARILEX® AKKU BRUSHLESS basic set / basic device (without CAS batteries, charger or accessories)

Item	Plug type	Cable type	Mains connection (V ~ Hz)	Power (V)	Mount	Speed (rpm)	Weight (kg)	Discs up to (Ø mm)	Pkg. unit	Article number
Basic set	EU (C+F)	Permanent connection	220 – 240 – 50 – 60	18	M14 thread	2,000 – 7,600	1.75	125	1	65281
Basic device	EU (C+F)	Permanent connection	220 – 240 – 50 – 60	18	M14 thread	2,000 – 7,600	1.75	125	1	65282

Scope of delivery

VARILEX® AKKU BRUSHLESS basic set:

- 1 VARILEX® AKKU BRUSHLESS basic device
- 1 Robust, impact-resistant plastic case
- 1 Particulate matter protection cap
- 2 LiHD batteries 18 volts with 5.5 Ah capacity (CAS)
- 1 Fast charger incl. cable (CAS)
- 1 Protective cover up to Ø 125 mm
- 1 Cut-off wheel cover clip up to Ø 125 mm
- 1 Clamping nut
- 1 Chuck key
- 10 High-performance flap discs Ø 125 mm
- 10 Premium cutting discs Ø 125 x 1.0 mm



Please note: Practical accessory sets from page 26, batteries and chargers see page 229.

Scope of delivery

VARILEX® AKKU BRUSHLESS basic device:

- 1 VARILEX® AKKU BRUSHLESS basic device 18 V
- 1 Robust, impact-resistant plastic case
- 1 Clamping nut
- 1 Chuck key



Attention: No battery and no charger included!

One battery, many solutions. Cross-brand. 100% Compatibility.



VARILEX® ANGLE GRINDERS

Accessories

GrinderGRIP

Magnet machine holder – easier, safer, practical.

The angle grinder accessory that **makes work easier, safer and more convenient**. Attach your angle grinder securely to a **magnetic surface** when you “put it down” and **keep it out of danger and still within reach!**

A particularly **powerful magnetic holder**, adaptable to many of the commercially available **angle grinders**, promises attachment of the grinder to any magnetic surface in seconds. Such as e.g. on **metal walls, tables, car bodies, plates, metal columns** and much more! This **effectively prevents the grinder from falling down** and enables **lightning-fast access** to the grinder in any position. **Adhesive force up to approx. 10 kg!** The magnetic block is attached to your angle grinder using metal brackets on the side and the corresponding screws. **It couldn't be more practical or safer!**

Benefits at a glance

- Securely attaches your angle grinder to magnetic surfaces.
- Particularly **powerful magnet – adhesive force approx. 10 kg.**
- **Improves work efficiency.**



Patent Pending.
Grinder Grip™ is a trademark used under license.

Technical specifications

Can be used with	Tool holder width (mm)	Weight (kg)	Pkg. unit 	Article number
VARILEX® 1802 HT, VARILEX® 1800, VARILEX® 1600, VARILEX® 1100	78.3	0.27	1	65028

Compatible with the following angle grinders from other manufacturers:

METABO W*18 series; W12* series; WE*** series / FEIN CCG 18* series; WSG-* series / BOSCH GWS* series; GWX* series / AEG WS 15 series; Milwaukee AVG 17 series; AS 12 E series



The Grinder Grip™ holds your machine on any ferromagnetic surface!

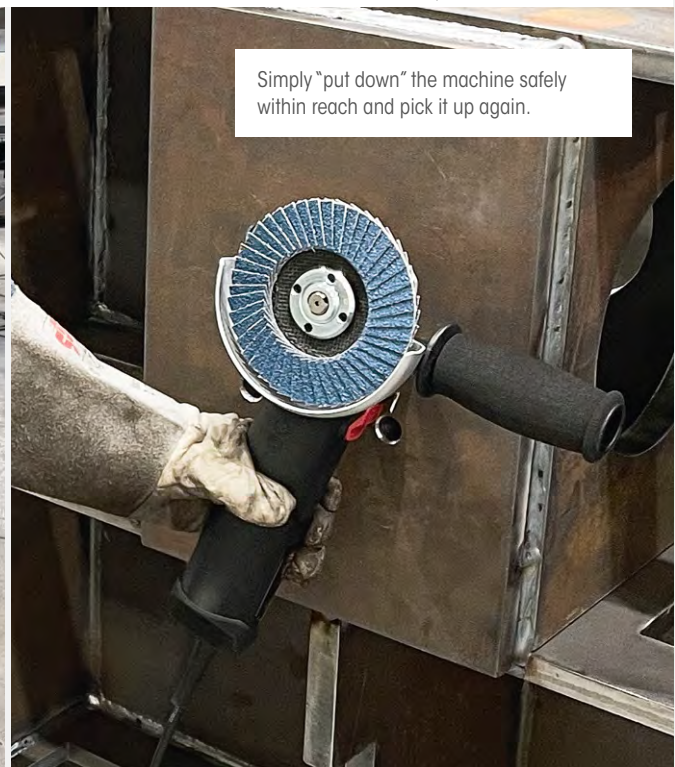

Simply “put down” the machine safely within reach and pick it up again.

SUITABLE FOR VARILEX®

Protective covers and cut-off wheel cover clips

For the safe use of grinding and cutting discs with VARILEX® angle grinders. With locking mechanism or clips for easy changing.



Technical specifications

Item	Dimensions (mm)	Can be used with	Pkg. unit 	Article number
Protective cover	Ø 125	VARILEX® 1802 HT, VARILEX® 1100	1	65042
Protective cover	Ø 150	VARILEX® 1802 HT	1	65043
Protective cover	Ø 125	VARILEX® 1800	1	65020
Protective cover	Ø 150	VARILEX® 1800	1	65021
Cut-off wheel cover clip	Ø 125	Protective cover VARILEX® 1100, VARILEX® 1802 HT, VARILEX® AKKU BRUSHLESS	1	65045
Cut-off wheel cover clip	Ø 150	Protective cover VARILEX® 1802 HT	1	65046

SUITABLE FOR M14 THREADS



Conical Clamping Nut

Ultra-flat, blackened steel locking nut (just 4 mm) including chuck key for flat flange recesses and tools. For locking conical tools onto angle grinders.

Technical specifications

Diameter	45 mm
Thread	M14
Pkg. unit	1
Article number	65004

SUITABLE FOR M14 THREADS



Height-adjusting washer

Height-adjusting washer for the angle grinder spindle (for M14 only) for discs of up to Ø 178 mm with extra-long drive spindle. Also increases the contact surface area.

Technical specifications

Suitable up to	Ø 178 mm
Thread	M14
Pkg. unit	1
Article number	65005

SUITABLE FOR M10 THREADS



Thread adapter M10 to M14

Screw on the adapter and high-tech European discs can also be used on angle grinders produced in Asia.

Technical specifications

Thread	M10
Pkg. unit	1
Article number	65006

VARILEX® ANGLE GRINDERS

Accessories

SUITABLE FOR VARILEX®

Rubber Ball Handle including L-shaped holder for angle grinders with M8 mounts

The soft rubber ball handle enables fatigue-free grinding in any working position without assuming an unnatural and strenuous hand position. This also makes overhead work child's play.



Technical specifications

Can be used with	Pkg. unit	Article number
VARILEX® power tools	1	65041



SUITABLE FOR VARILEX® 1802 HT

Protective suction cover

Suction hood with a brush ring and optimised flow channel for especially low-dust indoor and outdoor grinding.



Technical specifications

Item	Discs up to (Ø mm)	Connection for dust extraction (Ø mm)	Pkg. unit	Article number
Protective suction cover	125	35 / 41	1	65048
Replacement brush ring	-	-	1	65055



SUITABLE FOR VARILEX®

Flexible Shaft

Flexible shaft with steel core for working in narrow and particularly hard-to-reach places. All grinding tools of the MINI MAX®, the MINI FIX KLETT (VELCRO) and the PINLOC system can also be used with the flexible shaft.

With the flexible shaft with a robust 7 mm core and dockable M14 thread, your VARILEX® angle grinder can be upgraded to a professional drive motor.

With adapter for polishing rings up to Ø 150 mm.

Can be used with speed-controlled angle grinders, e.g.

VARILEX® 1802 HT, VARILEX® 1800, VARILEX® 1100,

VARILEX® 900 Duo or VARILEX® AKKU BRUSHLESS.



Technical specifications

Length (mm)	Collet (mm)	Mount	Maximum speed (rpm)	Can be used with (Ø mm)	Can be used with an adapter (for polishing rings Ø mm)	Pkg. unit 	Article number
1,420	6	M14 thread	12,000	up to 75	up to 150	1	10014



Flexible shaft can be used with these speed-controlled VARILEX® angle grinders:



VARILEX® 1802 HT

p. 16

NEW



VARILEX® AKKU BRUSHLESS

p. 20

NEW



VARILEX® 1100

p. 14



VARILEX® 1800

p. 18

VARILEX® ANGLE GRINDERS

Accessory sets

SUITABLE FOR VARILEX® 1802 HT - VARILEX® AKKU BRUSHLESS - VARILEX® 1100 - VARILEX® 1800

VARILEX® Coarse and Fine Grinding Accessory Set

34
TEILE
PARTS

This set allows performance of all work, from weld seam removal to surface cleaning to fine grinding, including cleaner and surface sealant. The ideal addition to any VARILEX® angle grinder.

Technical specifications

Application	Can be used with	Pkg. unit 	Article number
Coarse and fine grinding	VARILEX® 1802 HT, AKKU BRUSHLESS, VARILEX® 1100, VARILEX® 1800	1	65032

Contents:

- | | |
|--|---------------------------------------|
| 1 Mobile tool case | 1 MAGNUM® STAINLESS-CLEAN
Ø 125 mm |
| 10 MAGNUM® PRECICUT | 1 MAGNUM® CLEAN Strong Ø 125 mm |
| 5 MAGNUM® TWINFLEX® Ø 125 mm | 1 MAGNUM® CLEAN-MIX Ø 125 mm |
| 1 TRIMFIX® Fleece Flap 1FOR2
Ø 125 mm | 2 MAGNUM® fleece Top Ø 115 mm |
| 3 TRIMFIX® Fleece Flap Ø 125 mm | 1 COLDSTEEL® backing pad Ø 125 mm |
| | 8 COLDSTEEL® fibre discs Ø 125 mm |



The ideal supplement for these VARILEX® angle grinders:



VARILEX® 1802 HT

p. 16

NEW



VARILEX® AKKU BRUSHLESS

p. 20

NEW



VARILEX® 1100

p. 14



VARILEX® 1800

p. 18

SUITABLE FOR VARILEX® 1802 HT - VARILEX® AKKU BRUSHLESS - VARILEX® 1100 - VARILEX® 1800

VARILEX® FIX HOOK & LOOP Accessory Set

48
TEILE
PARTS

The ideal FIX HOOK & LOOP accessory package for diameters 60 and 115 mm. From coarse and fine grinding to a perfect mirror finish, including cleaner and surface sealing. The ideal addition to any VARILEX® 1100 or VARILEX® AKKU BRUSHLESS angle grinder.

Technical specifications

Application	Can be used with	Pkg. unit 	Article number
Coarse grinding to a mirror finish	VARILEX® 1802 HT, AKKU BRUSHLESS, VARILEX® 1100, VARILEX® 1800	1	65033

<p>Contents:</p> <ul style="list-style-type: none"> 1 Mobile tool case 1 FIX HOOK & LOOP special backing pad Ø 115 mm 1 FIX HOOK & LOOP soft damping adapter Ø 115 mm 3 FIX HOOK & LOOP Cool Top® flap discs Ø 115 mm 8 FIX HOOK & LOOP zircon discs Ø 115 mm 5 FIX HOOK & LOOP SC fleece discs Ø 115 mm 3 FIX HOOK & LOOP Trizact™ discs Ø 115 mm 2 FIX HOOK & LOOP BRIGHTEX® Berry discs Ø 115 mm 2 FIX HOOK & LOOP BRIGHTEX® Sun discs Ø 115 mm 1 MINI FIX HOOK & LOOP special baking pad Ø 60 mm 1 MINI FIX HOOK & LOOP soft damping adapter Ø 60 mm 	<ul style="list-style-type: none"> 3 MINI FIX HOOK & LOOP Cool Top® flap discs Ø 60 mm 5 MINI FIX HOOK & LOOP SC fleece discs Ø 60 mm 3 MINI FIX HOOK & LOOP Trizact™ discs Ø 60 mm 2 MINI FIX HOOK & LOOP BRIGHTEX® Berry discs Ø 60 mm 2 MINI FIX HOOK & LOOP BRIGHTEX® Sun discs Ø 60 mm 1 BRIGHTEX® Softclean Powder 1 BRILLIANCE CLEAN 50 ml 1 INOX PROTECT 50 ml 1 POWER CLEANER 50 ml 1 BRIGHTEX® microfibre cloth 	
--	---	---

The ideal supplement for these VARILEX® angle grinders:



VARILEX® 1802 HT

p. 16

NEW



VARILEX® AKKU BRUSHLESS

p. 20

NEW



VARILEX® 1100

p. 14



VARILEX® 1800

p. 18

CUTTING AND ROUGH GRINDING DISCS

SUITABLE FOR STAINLESS STEEL - STEEL

★★★★★

MAGNUM® PRECICUT Cutting Disc

The new generation of cutting discs:
Cut high-precision metal now!

Take the test with our new precision cutting disc!
Experience metal separation at a higher level than previously known.

The precise cutting of sheet metal parts, for example, **extremely precisely on line marking**, is often difficult ("deflection") due to the high flexibility with thin cutting discs, especially "free hand". In order to **maximize accuracy**, Eisenblätter now offers a **precision cutting disc** that makes this problem much easier. Thanks to the particularly compact shape of the centre, the new generation of cutting discs is **extremely dimensionally stable** and **torsion-proof**. Cutting, even of longer work piece sections, is much easier and more precise to carry out.

Due to the particularly reduced "crowning" centre, the possible incision depth is significantly higher than with comparable products. This expands the technical possibilities and significantly increases the service life through significantly more cuts. **This new generation of cutting discs** naturally offers **greater stability and safety** in "free precision cutting" and ensures exact and "thinner" metal cuts.

Particular emphasis was placed on "bite" and **extremely high durability**. It is certainly one of the **most powerful cutting discs** in the metal sector. **MAGNUM® PRECICUT** is a **universal cutting disc** that shows its advantages in almost all metal areas – **from stainless steel to steel**. Thanks to a new, **clever formula**, the **aging resistance** could be increased enormously. Conventional cut-off wheels generally become softer in the bond when stored for a long time and lose their original aggressiveness and service life during storage!

Benefits at a glance

- Ideal for **precise cutting from stainless steel to steel**.
- Exact, **straight cuts even with freehand cuts**.
- **Largest possible cutting depth** thanks to the small 55 mm metal hub in the centre.
- **Twist-proof and dimensionally stable** thanks to the cranked shape.
- **High security thanks to the metal centre** – no grinding through possible.
- **ANTI-AGING SYSTEM**: Hardly any loss of performance, even after long periods of storage.
- Special formula for a **long service life and high stock removal rate**.
- **Exactly 1 mm** – for particularly thin cuts at high cutting speeds.
- Very little heat development when cutting – **no tarnish**.
- **No vibrations, no bending or fluttering** while cutting.





MAGNUM® PRECICUT:
"real" 1 mm thin!

No tarnishing when cutting stainless steel!

Exact, straight cuts even with freehand cuts.

Technical specifications **MAGNUM® PRECICUT cutting disc**

Dimensions (mm)	Thickness (mm)	Maximum speed (rpm)	Approved for (DIN EN 12413)	Shape	Hardness	Pkg. unit 	Article number
Ø 125 x 22.2	1.0	12,250	80 m/sec	 off-set	hard	25	85512



Eisenblätter
MAGNUM® PRECICUT
cutting disc with
a narrow metal hub

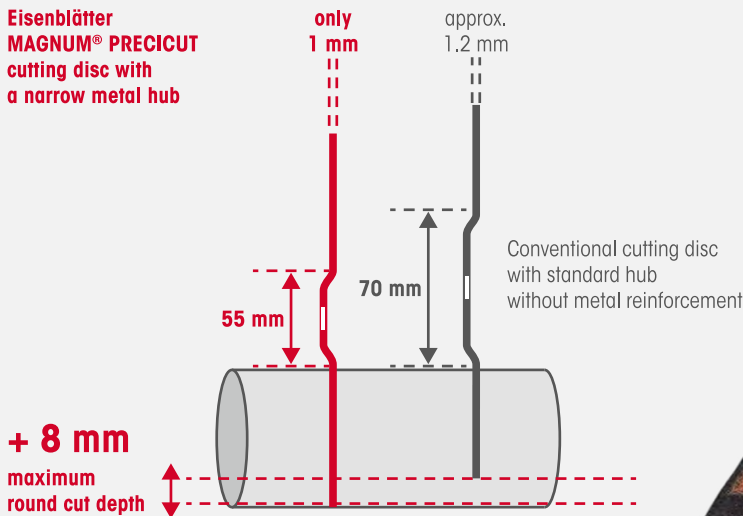

- 1** Exact 1 mm thickness for maximum precision.
- 2** Maximum depth of cut thanks to tight "crowning".
- 3** Metal hub for maximum security.



CUTTING AND ROUGH GRINDING DISCS

SUITABLE FOR ALL METALS ★★★★★

MAGNUM® RAZORCUT®

Universal Platinum Long-life cutting disc for all metals



Revolutionary cutting disc with unparalleled performance (up to 150 cuts / test material: stainless steel pipe Ø 27 mm with 2-mm wall thickness). The high-performance cutting disc is remarkable for its high precision, aggressive cutting speed, and extremely long service life.



Benefits at a glance

- The disc thickness of exactly 1 mm allows **exceptionally precise cuts**.
- Ideally **suited to all metals** – simplifies material procurement and storage.
- Up to **50% better performance** than conventional products.
- Considerably fewer disc changes means **huge working time savings**.

Technical specifications

Dimensions (mm)	Thickness (mm)	Maximum speed (rpm)	Approved for (DIN EN 12413)	Shape	Hardness	Pkg. unit 	Article number
Ø 125 x 22.2	1	12,200	80 m/sec	 straight	hard	25	85122



SUITABLE FOR ALL METALS ★★★★★

MAGNUM® FINECUT

Premium cutting disc

Special high-performance cutting disc for thin-walled profiles and pipes and premium quality job. The disc thickness of exactly 1 mm allows exceptionally precise cuts. Ideally suited to all metals – simplifies material procurement and storage. Free from iron, sulfur and chlorine.



Technical specifications

Dimensions (mm)	Thickness (mm)	Maximum speed (rpm)	Approved for (DIN EN 12413)	Shape	Hardness	Pkg. unit	Article number
Ø 115 x 22.2	1	13,300	80 m/sec	straight	hard	25	85111
Ø 125 x 22.2	1	12,200	80 m/sec	straight	hard	25	85112



SUITABLE FOR ALL METALS ★★★★★

MAGNUM® TWINFLEX®

Universal cutting and rough grinding in a single disc

The combination disc allows cutting and rough grinding with a single product. It is indispensable during jobs where workers are constantly changing discs over. Ideally suited for alternating cutting and grinding applications.



Technical specifications

Dimensions (mm)	Thickness (mm)	Maximum speed (rpm)	Approved for (DIN EN 12413)	Shape	Hardness	Pkg. unit	Article number
Ø 125 x 22.2	2.5	12,200	80 m/sec	off-set	hard	25	85412



CUTTING AND ROUGH GRINDING DISCS

SUITABLE FOR ALL METALS ★★★★★

MAGNUM® FLEXO

Universal premium rough grinding disc for all metals

The outstanding features of this universal rough grinding disc are its great aggressiveness, long service life, and material removal performance. Ideal for stainless steel. Eminently suited for difficult deburring jobs.



Benefits at a glance

- **Suited to all metals** – simplifies material procurement and storage.
- Considerably fewer disc changes means **huge working time savings**.

Technical specifications

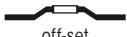
Dimensions (mm)	Thickness (mm)	Maximum speed (rpm)	Approved for (DIN EN 12413)	Shape	Hardness	Pkg. unit	Article number
Ø 125 x 22.2	6	12,200	80 m/sec	 off-set	medium	10	85312



SELF-TRIMMING, LONG SERVICE LIFE

BALANCED CO₂ BALANCE

HIGH ELASTICITY, LOW VIBRATION

REDUCED NOISE LEVELS

LOW GRINDING TEMPERATURE

100 % MADE IN GERMANY



Eisenblätter flap discs – unrivalled in technology and performance

At the end of the **1970s**, Eisenblätter developed the **world's first zirconium-based flap disc for high-speed angle grinders**. This led to the **unparalleled triumph** of today's known **flap disc** on all continents. Eisenblätter is undoubtedly one of the **initiators** and pioneers of **today's modern flap discs**.

With over 50 years of experience in the manufacture and innovation of flap discs, we offer the most advanced technology and are now one of the largest manufacturers in the world. **In terms of environmental friendliness, removal rate, durability and quality**, Eisenblätter flap discs are among the **absolute top class and benchmarks** in the industry.

Simply superb

Material removal, grinding quality, and service life: The grit mix and abrasive cloth and the right combination of elastic backing material, flap angle, hard compression, and gluing system ensure performance and service life.

Environmentally and user-friendly

At Eisenblätter, we attach the greatest value to environmental user-friendliness in our selection of raw materials. **We don't use glass fibre, mineral fibres, or epoxy resins in our products**. We use **sustainable, renewable raw materials** to produce our natural fibre compound flap discs. Right from the start, we've used food-grade special plastics for our backing plates. Eisenblätter's greatest contribution to environmental friendliness, high-tech components, and user protection was the **development of its natural fibre compound backing plate**. This **revolutionary technology raised grinding technology to a new level**. Today, it offers the highest in **resource conservation and environmental friendliness** – with up to 50% less CO₂ emissions during production. The grit mix and abrasive cloth were refined and many grinding processes simplified and revolutionised.

Advantages:

- **Improved adaptation to the work piece because of the elasticity offered by all backing technologies available from Eisenblätter**
- **Self-trimming, which for the first time allows 100% of the abrasive cloth to be used**
- **No troublesome fibre glass dust**
- **Reduced noise level and vibrations**
- **Maximum service life for all components because of painstaking test procedures and unique patented manufacturing processes**

Unique, revolutionary manufacturing processes

The special manufacturing process gives the abrasive cloth its necessary moisture and elasticity, greatly extending fabric durability. The abrasive flaps are anchored and hard-compressed in an elastic system. This has an enormously positive effect on flap disc service life.

Safety, quality, tests

A great deal of testing apparatus and many robots are in use every day to test and ensure the systems' high performance. But manual tests are also important for simulating extreme conditions. Many of our products are also **tested and certified by MPA Hanover**, one of the oldest and most experienced **official materials testing institutes in Germany**.

Eisenblätter natural fibre backing plate – completely free of fibreglass

With the invention and development of the natural fibre compound backing plate for abrasive technology, a completely new chapter in the manufacture of grinding wheels in terms of performance, technology and environmental compatibility was opened. Years of experience in the development of natural fibre technology has resulted in a superior surface finish that customers always benefit from in everyday use.

Grinds down to the last millimetre

Backing plates made of natural fibre compound trim themselves during the grinding process. Trimming during machining is also simple and easy (it gives off a pleasant wood chip smell). Flap discs with natural fibre compound backing plates can be used right down to the last millimetre of abrasive cloth. Trimming leaves soft, harmless shavings which can be disposed of as household waste.

Easy trimming during operation

Flap discs with natural fibre compound backing plates have a fibre substrate with damping, even elastic properties that enhance their performance in grinding operations. This backing plate elasticity allows better adjustment, a larger contact surface area on the work piece (more grit being used), and, of course, more material removal. The greater contact surface area dissipates more heat, grinding is cooler, the work piece does not tarnish as easily, and the abrasive cloth does not burn.

Advantages of natural fibre compound backing plates

- 100% made in Germany
- Much greater elasticity and better work piece adaptation
- Large grinding area results in low grinding temperatures
- Self-trimming properties for up to 100% use of the abrasive cloth
- This allows immediate cost savings of at least 30-40%
- Heat insulation, damping properties
- Lower noise level and less vibration during grinding
- No danger of injury from sharp fibre glass edges
- No fibre glass dust in the air
- Backing plates are resistant to most chemicals
- Very great work safety
- Sustainable raw materials ensure a low CO₂ footprint

Eisenblätter grinding discs with natural fibre backing plates for more power, longer service life and more efficient work!

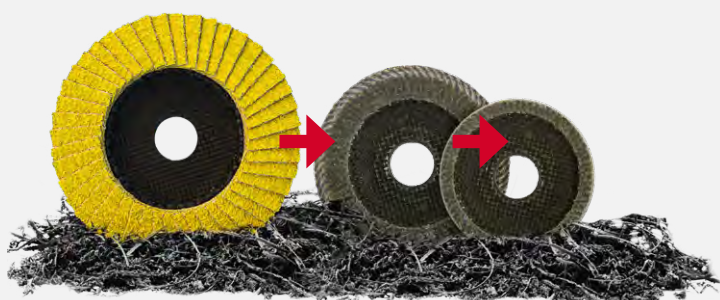

Self-trimming in the outer diameter, 100% usable fabric.

Eisenblätter grinding discs with natural fibre backing pad:

- TRIMFIX® MUSTANG flap disc 36
- TRIMFIX® HellFire® flap discs 38
- TRIMFIX® SteelFire® flap discs 40
- TRIMFIX® BLACK MAMBA® flap disc 42
- TRIMFIX® ZIRCOPUR® flap disc 44
- PLANTEX® Cool Top® Universal flap disc 46
- COLDSTEEL® RazorFlap® grinding disc 56
- MAGNUM® DecoFinish 66
- TRIMFIX® Fleece Flap 1FOR2 68
- TRIMFIX® Fleece Flap 69
- MAGNUM® Top Mix Strong 73
- MAGNUM® CLEAN-MIX 74
- MAGNUM® CLEAN-PLUS 75
- MAGNUM® STAINLESS-CLEAN 76
- BRIGHTEX® FLAP Berry (pre-polishing) 78
- BRIGHTEX® FLAP Sun (post-polishing) 78

Ideal work piece adaptation with a visco-elastic backing plate

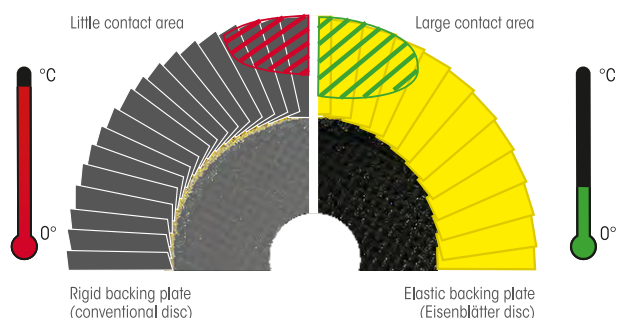

The patented Eisenblätter production process means that only Eisenblätter grinding discs are truly flexible. This allows not only more efficient work, but also reduced grinding temperature due to the larger work piece support area. **Quality has been certified by the MPA Hanover materials testing agency.**



FLAP DISCS

Grinding and blending

SUITABLE FOR STAINLESS STEEL · STEEL

TRIMFIX® MUSTANG® Flap Disc

The new generation of zircon:
high performance on stainless steel and steel!

Experience an increase in stock removal that was previously only possible with high-priced ceramic flap discs:

Performance increases of over 40% for stainless steel and 30% for steel without the addition of ceramic grain – Eisenblätter TRIMFIX® MUSTANG®!

Thanks to a sophisticated zirconium recipe based on the latest sintering technology in combination with a special lamella configuration, the TRIMFIX® MUSTANG® flap disc achieves enormous removal speeds. And that saves a lot of working time costs. **Time is money** and labour costs often represent the main part of any cost calculation. In addition, compared to other flap discs available on the market, the TRIMFIX MUSTANG® is **extremely powerful, extremely inexpensive** and often **technically superior!** Thanks to the **special lamella configuration**, the abrasive grain retains its cutting ability and sharpness even under high pressure, so that for the first time **stainless steel** can also be processed perfectly – without the risk of grain rounding and glazing.

The TRIMFIX® MUSTANG® flap disc is also only supplied on the **natural fibre compound backing plate** available exclusively from Eisenblätter and thus has many other important advantages – see page 35.

Take the test!

Increase your performance and reduce your costs!

Benefits at a glance

- Higher productivity – performance jump of 30 – 40%.
- New zirconium grain formulation and special lamella configuration.
- Machining **stainless steel and steel** equally in high performance.
- Improved grinding sharpness, no grain rounding, no glazing.
- **100% use of all slats** thanks to “self-trimming”.
- **Extremely long service life**, less frequent disc changes.
- **Carrier plate made of natural fibre compound**, user-friendly and environmentally friendly.
- **Balanced CO₂ balance** thanks to renewable raw materials.
- **Backing plate environmentally friendly**, elastic, adapting to the work piece.
- **No fibre optics** in the room air.
- **Substantial savings in the cost balance.**

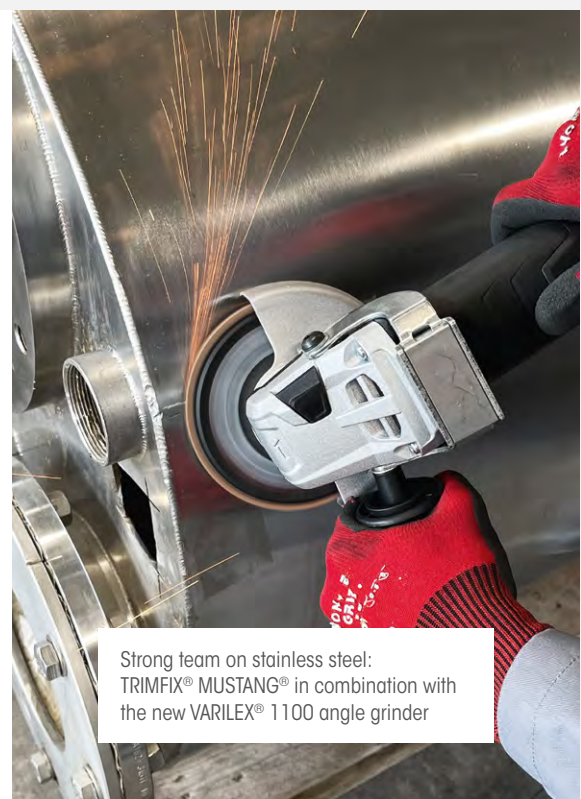

Strong team on stainless steel:
TRIMFIX® MUSTANG® in combination with
the new VARILEX® 1100 angle grinder

High performance on stainless steel and steel

TRIMFIX® MUSTANG® – Increase performance and save costs!

Performance increase* on stainless steel

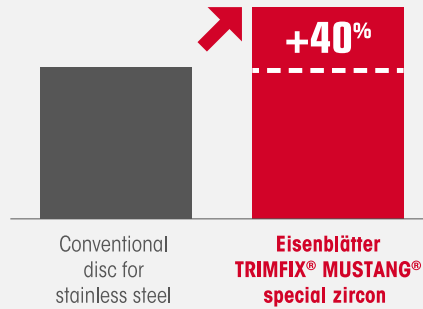

Performance increase* on steel

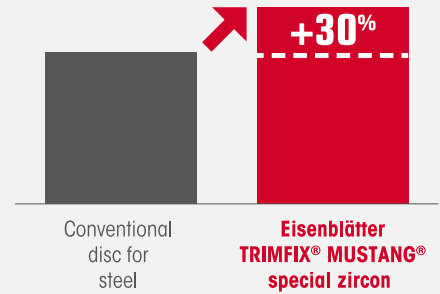

* Determined by in-house grinding tests.

Technical specifications TRIMFIX® MUSTANG® flap disc

Dimensions (mm)	Ideal speed (rpm)	Maximum speed (rpm)	Approved for (DIN EN 13743)	Backing plate	Pkg. unit	Grit (K)	Article number
Ø 115 x 22.2	7,000 – 9,000	13,200	80 m/sec	Natural fibre	40	40	91814
						60	91816
Ø 125 x 22.2	6,000 – 8,000	12,200	80 m/sec	Natural fibre	40	40	91824
						60	91826
Ø 178 x 22.2	5,000 – 6,000	8,500	80 m/sec	Natural fibre	40	40	91844
						60	91846



- 1 New zircon recipe and special lamella configuration** massively increase the removal rate and thus the savings in working time with a long service life at the same time.
- 2 Elastic natural fibre high-tech compound carrier plate** protects the environment and the user (CO₂-neutral), completely self-trimmable for 100 percent use of the pane, noise and vibration dampening.
- 3 Very high amounts of abrasive**

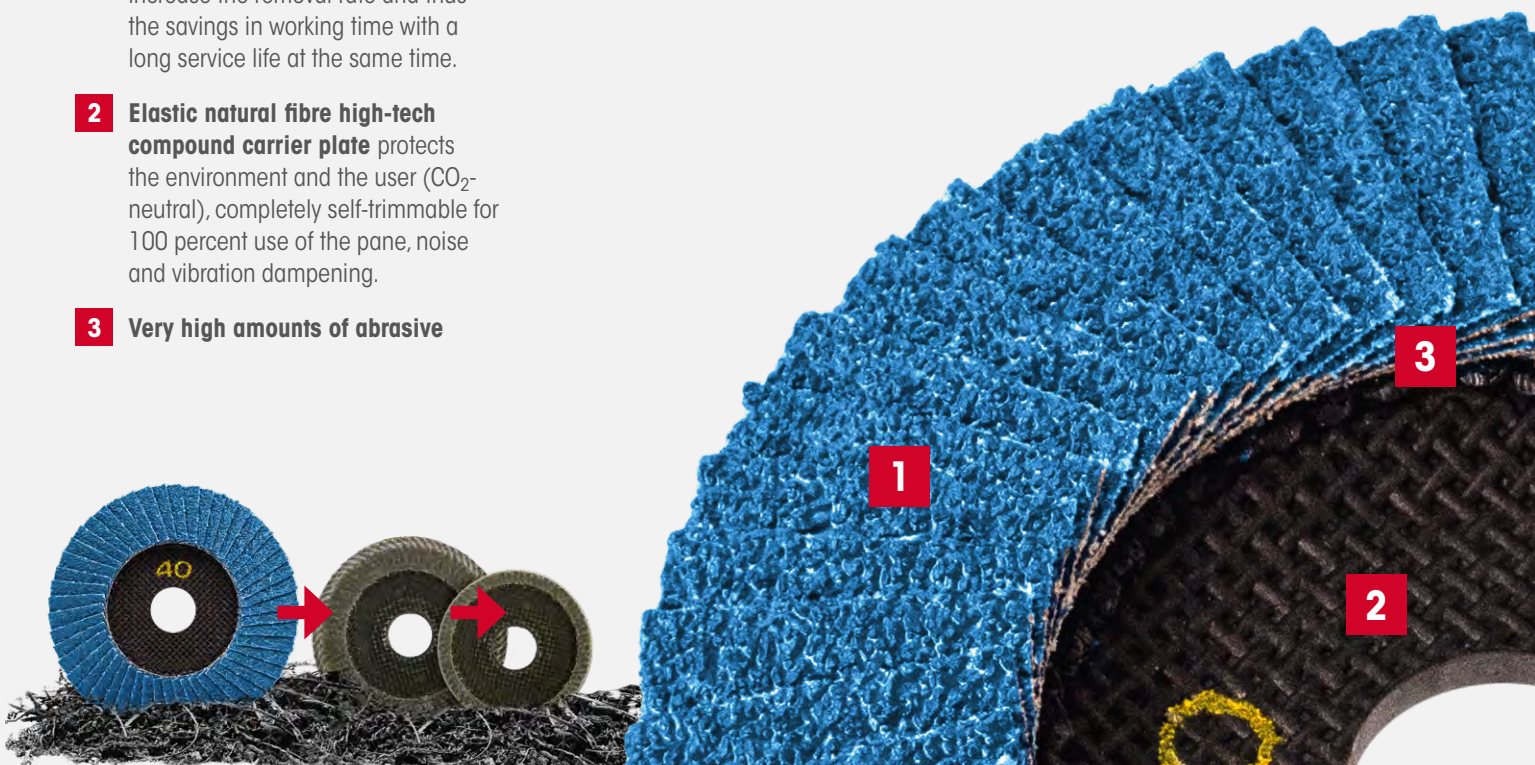

Self-trimming in the outer diameter, 100% usable fabric.

FLAP DISCS

Grinding and blending

SUITABLE FOR ALL METALS

TRIMFIX® HellFire®

**Ceramic hybrid:
1 disc + 1 grit for all metals**

The TRIMFIX® HellFire® is one of the most modern and versatile flap discs in the world. Thanks to the unique, innovative **ceramic hybrid technology**, **all metals can be processed in record time with just one grit**. User-friendly thanks to the absence of glass fibre components, environmentally friendly thanks to the use of CO₂-neutral natural fibre components. Working time and tool costs are halved – and at an absolutely outstanding price-performance ratio.



Benefits at a glance

- 40 grit material removal with 60 grit grinding results.
- Multigrain (40/60) saves on extra storage required for different grits.
- New ceramic hybrid fabric allows work piece grinding with just one grit in the coarse-to-medium grit range.
- Fewer work steps at the highest level of performance.
- Elastic natural fibre high-tech compound carrier plate protects the environment and users (CO₂-neutral), completely self-trimmable for complete use of the disc, noise and vibration dampening.
- Especially soft grinding transitions thanks to ideal work piece adaptation.

The TRIMFIX® HellFire® achieves the same high grinding performance on all metals.



TRIMFIX® HellFire® guarantees first-class work results: Even extremely strong, tough steel, such as e.g. B. a Leopard 2 tank tube, can be machined without any problems.

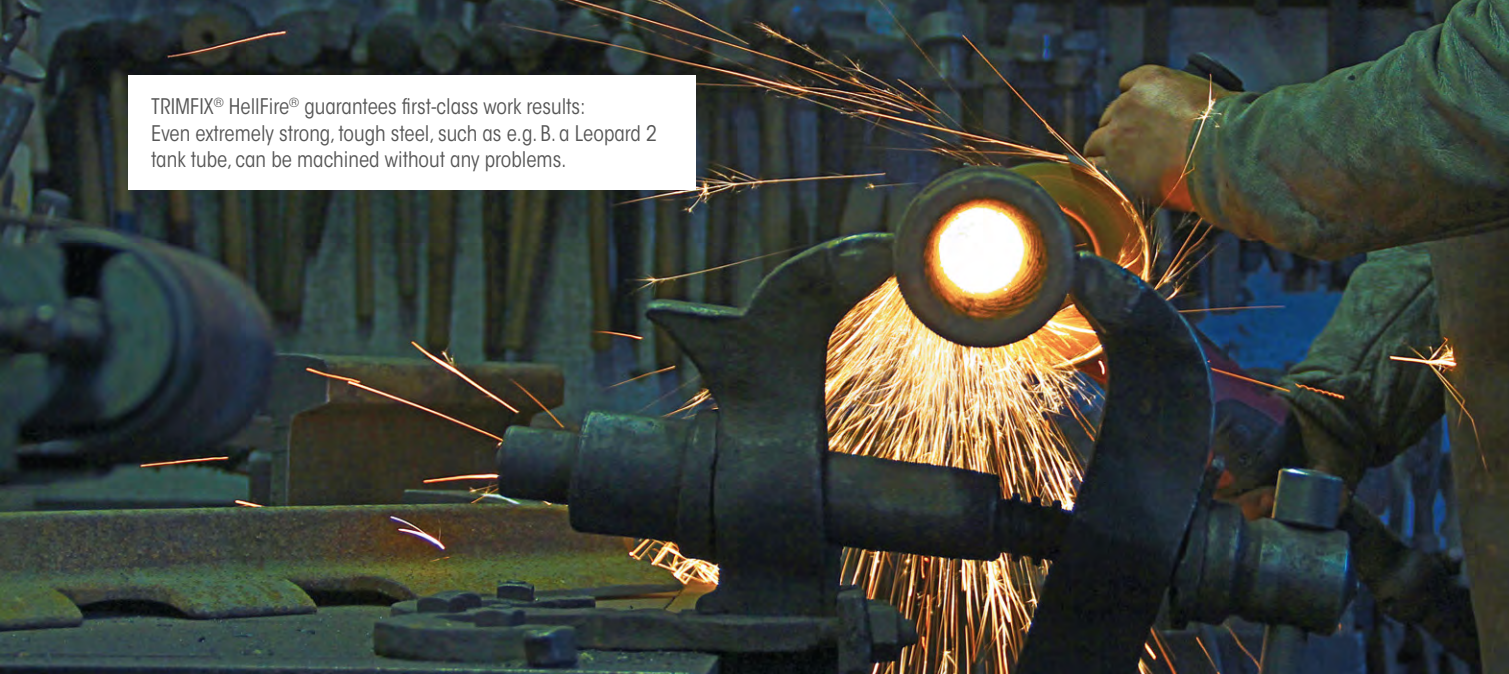

Technical specifications TRIMFIX® HellFire® flap disc

Dimensions (mm)	Ideal speed (rpm)	Maximum speed (rpm)	Approved for (DIN EN 13743)	Backing plate	Pkg, unit 	Grit (K)	Article number
Ø 100 x 16.0	8,000 – 10,000	15,000	80 m/sec	Natural fibre	40	Multigrain 40/60	91521
Ø 115 x 22.2	7,000 – 9,000	13,200	80 m/sec	Natural fibre	40	Multigrain 40/60	91530
Ø 125 x 22.2	6,000 – 8,000	12,200	80 m/sec	Natural fibre	40	Multigrain 40/60	91540
Ø 150 x 22.2	6,000 – 7,000	10,000	80 m/sec	Natural fibre	40	Multigrain 40/60	91547
Ø 178 x 22.2	5,000 – 6,000	8,500	80 m/sec	Natural fibre	40	Multigrain 40/60	91549











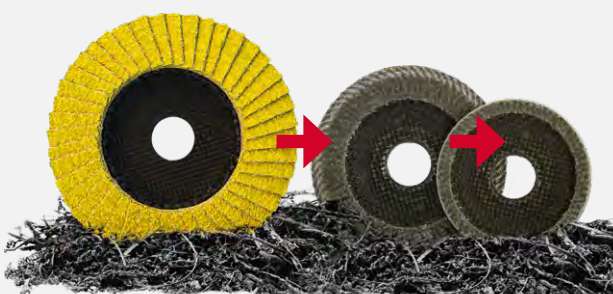
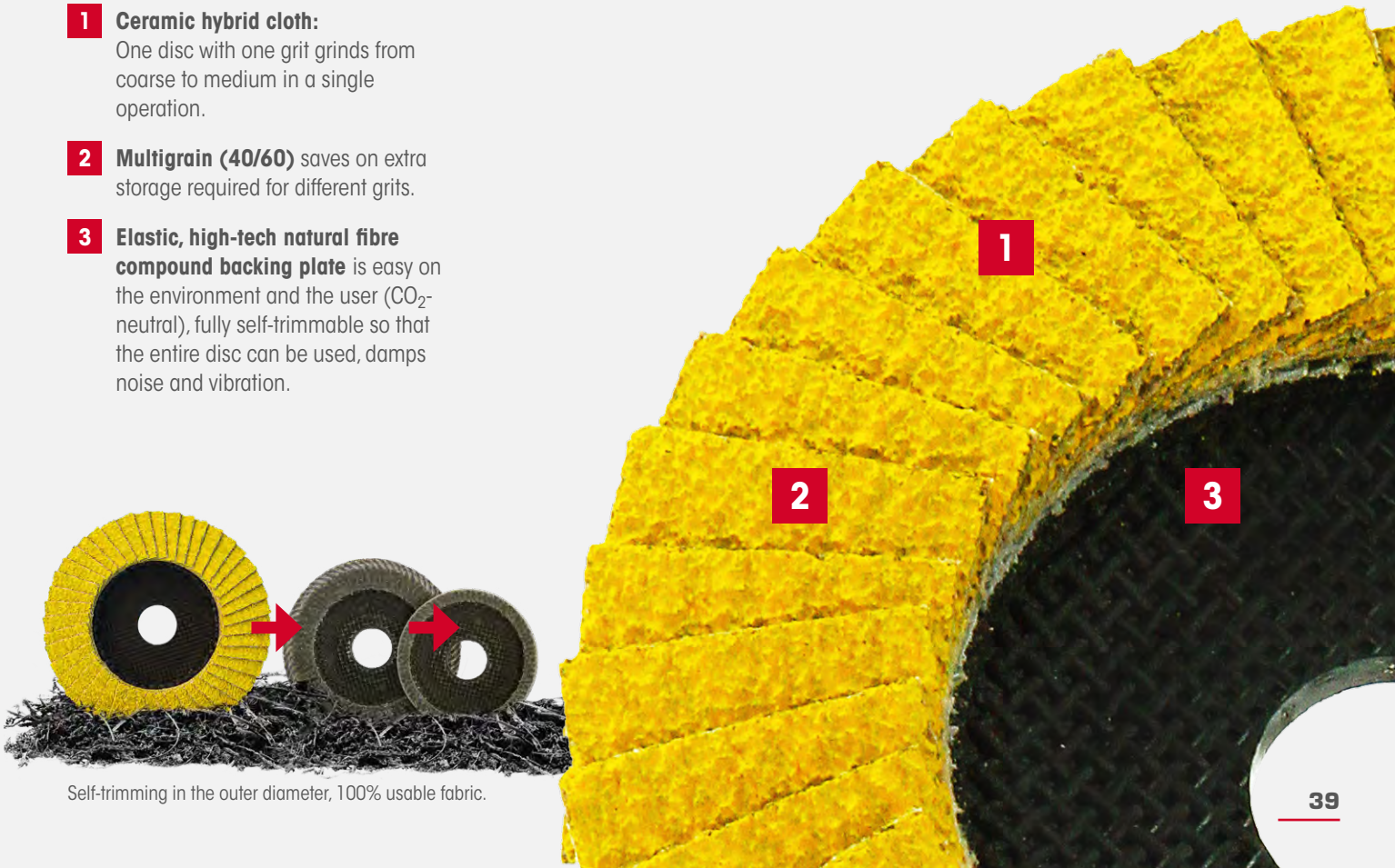

- 1 Ceramic hybrid cloth:**
One disc with one grit grinds from coarse to medium in a single operation.
- 2 Multigrain (40/60) saves on extra storage required for different grits.**
- 3 Elastic, high-tech natural fibre compound backing plate** is easy on the environment and the user (CO₂-neutral), fully self-trimmable so that the entire disc can be used, damps noise and vibration.



Self-trimming in the outer diameter, 100% usable fabric.

FLAP DISCS

Grinding and blending

SUITABLE FOR STEEL

TRIMFIX® SteelFire®

The performance miracle on steel – unprecedented flap disc steel removal

In order to counter the growing pressure of labour costs, Eisenblätter is launching a **new generation** of flap discs **for steel machining** based on 45 years of experience in developing cutting-edge grinding tools. This revolutionary product was developed especially for high-performance areas in **steel construction** such as **shipyards, bridge-building, railroads, energy-sector construction, and building construction and civil engineering**: anywhere where it is important to work effectively in the shortest possible time. The special formulation with hybrid grit technology and patented arrangement of abrasive cloth ensures material removal rates that were unimaginable a short time ago.



Benefits at a glance

- High-tech **zirconium hybrid flap disc**, especially for time-saving high-speed steel removal.
- Uniform grinding results and cool grinding – without discolouration.
- Elastic **natural fibre high-tech compound carrier plate protects the environment and users (CO₂-neutral)**, completely **self-trimmable** for complete use of the disc, **noise and vibration dampening**.
- The visco-elastic backing plate ensures **optimum work piece adaptation for particularly soft grinding transitions**.
- **Great labour savings.**
- Its **enormous material removal** and rapid grinding effect lead us to recommend a performance-optimised, variable-speed, high-torque angle grinder – VARILEX® 1802 HT from Eisenblätter meets every element of this description and is the ideal counterpart for the TRIMFIX® SteelFire® flap disc (see page 16).
- Also suitable for stainless steel (Fe-S-CI<0.1%).



Together with the newly developed, high-torque angle grinder VARILEX® 1802 HT, working times can be shortened enormously and labour costs massively reduced.

High speed stock removal on steel with extreme service life.
The cheapest way to grind!

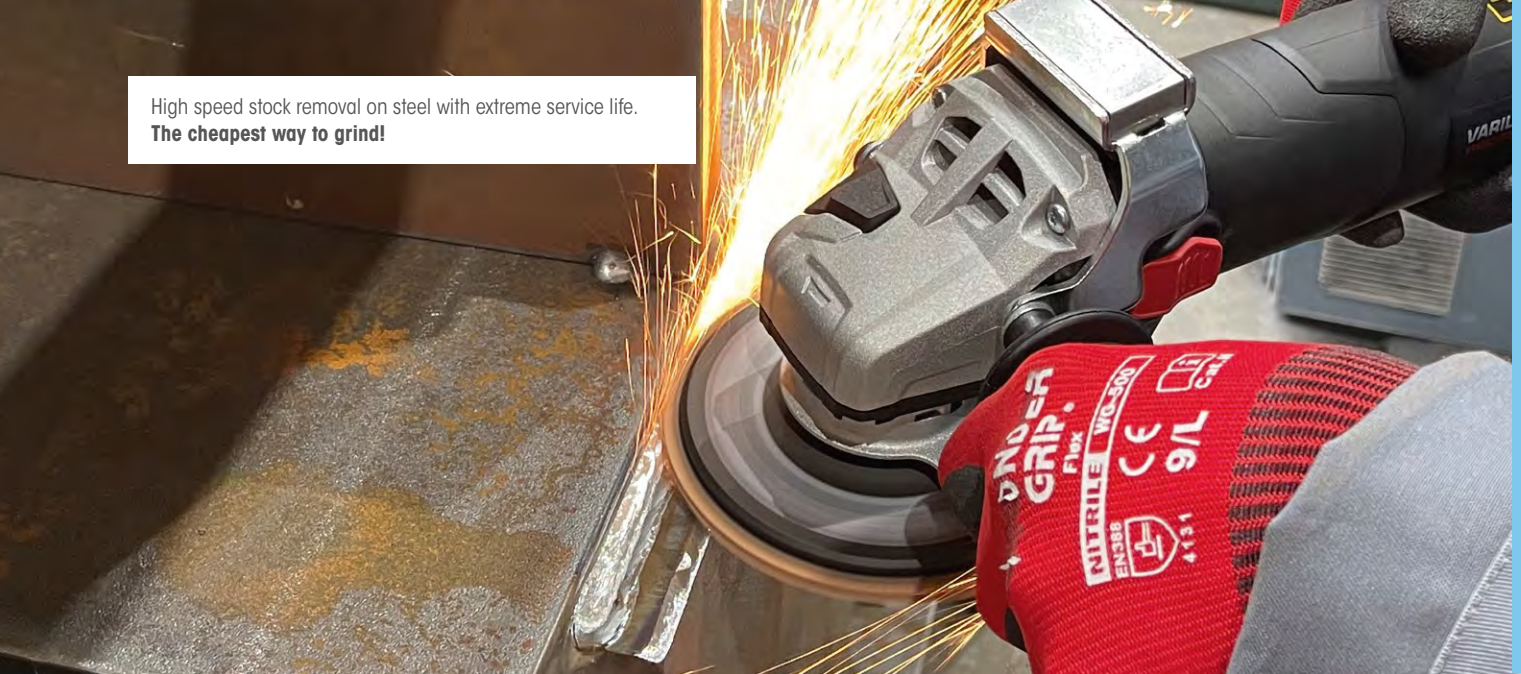

Technical specifications TRIMFIX® Steelfire® flap disc

Dimensions (mm)	Ideal speed (rpm)	Maximum speed (rpm)	Approved for (DIN EN 13743)	Backing plate	Pkg. unit 	Grit (K)	Article number
Ø 115 x 22.2	7,000 – 9,000	13,200	80 m/sec	Natural fibre	40	40	91364
						60	91366
Ø 125 x 22.2	6,000 – 8,000	12,200	80 m/sec	Natural fibre	40	40	91374
						60	91376
Ø 150 x 22.2	6,000 – 7,000	10,000	80 m/sec	Natural fibre	40	40	91384
						60	91386
Ø 178 x 22.2	5,000 – 6,000	8,500	80 m/sec	Natural fibre	40	40	91394
						60	91396



1 The zirconium hybrid cloth ensures consistent performance and long service life to the end of the disc.

2 Elastic, high-tech natural fibre compound backing plate is easy on the environment and the user (CO₂-neutral), fully self-trimmable so that the entire disc can be used, damps noise and vibration.

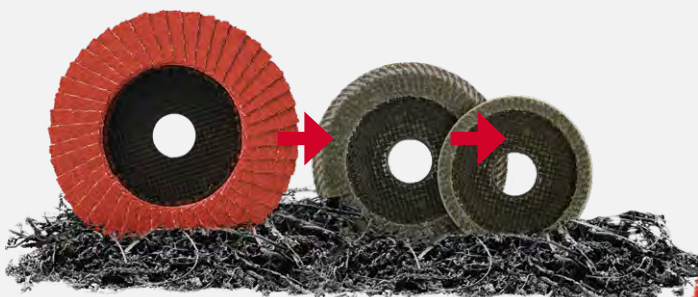
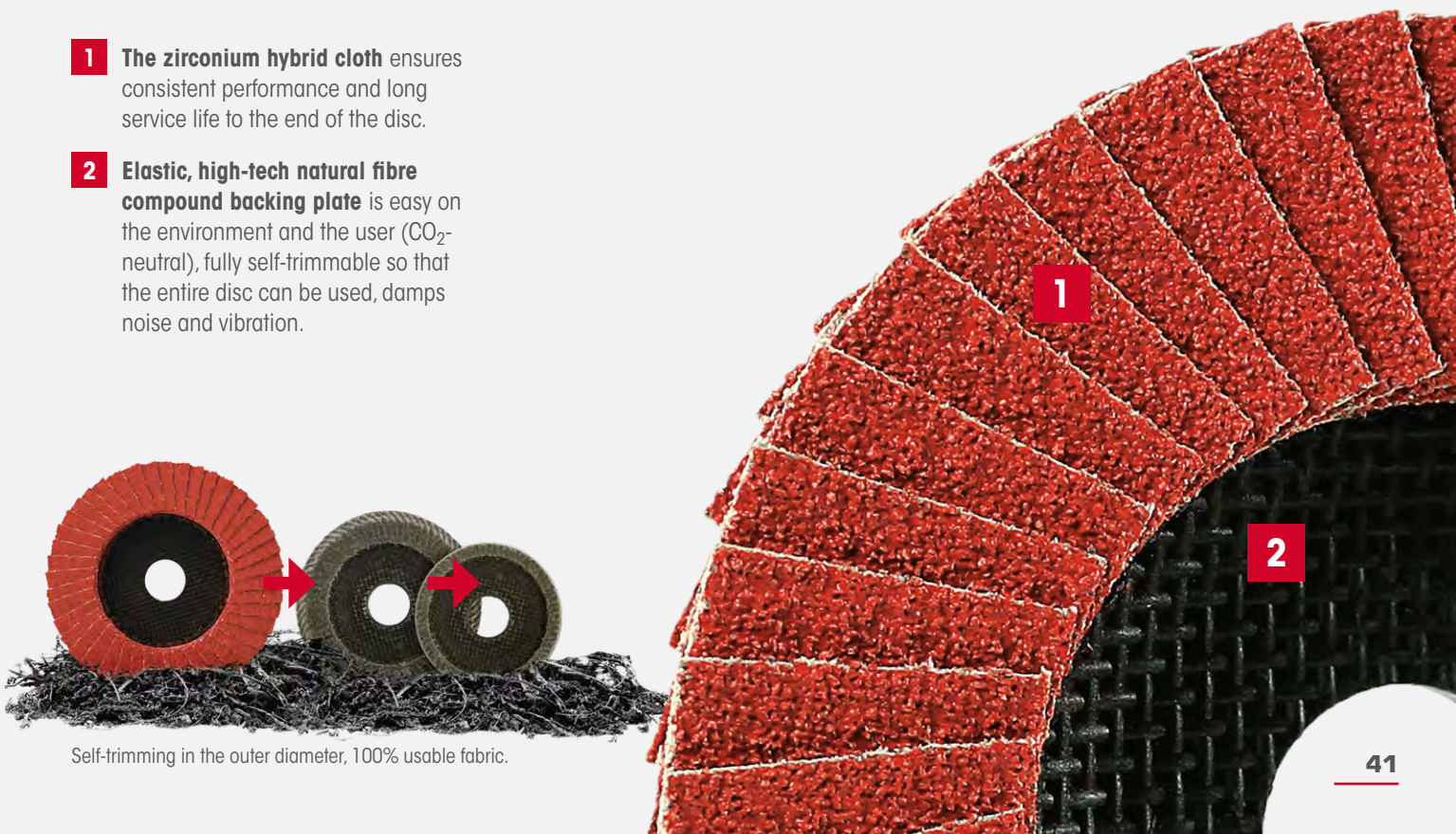

Self-trimming in the outer diameter, 100% usable fabric.

FLAP DISCS

Grinding and blending

SUITABLE FOR STEEL · STAINLESS STEEL

TRIMFIX® BLACK MAMBA®

One of the most powerful flap discs on steel

The TRIMFIX® BLACK MAMBA® is a **high-performance flap disc** for **steel**. It is designed to deliver extremely long service life and exceptional material removal for modern **steel machining operations**. The newly developed pure zirconium cloth with cooling agents and great abrasive content makes it ideal for machining all grades of **steel up to stainless steel**. The backing plate is made of **natural fibre** and is environmentally and user-friendly while adjusting flexibly to the work piece, guaranteeing **smooth grinding transitions**.

The TRIMFIX® BLACK MAMBA® can be trimmed, allowing significant tool cost saving. Up to 4.5 kg of steel can be removed using just one BLACK MAMBA® Ø 125 mm grit 40 disc.



Benefits at a glance

- The high-performance flap disc offers exceptional service life and material removal for steel and stainless steel.
- Newly developed pure zirconium cloth with cooling agents guarantee cool grinding and performance throughout the service life.
- Sets new performance records with a nominal removal rate of up to 4.5 kg of steel (depending on grit size).
- Ideal work piece adaptation ensures especially soft grinding transitions.
- Elastic natural fibre high-tech compound carrier plate protects the environment and users (CO₂-neutral), completely self-trimmable for complete use of the disc, noise and vibration dampening.



Technical specifications TRIMFIX® BLACK MAMBA® flap disc

Dimensions (mm)	Ideal speed (rpm)	Maximum speed (rpm)	Approved for (DIN EN 13743)	Backing plate	Pkg. unit 	Grit (K)	Article number
Ø 100 x 16.0	8,000 – 10,000	15,000	80 m/sec	Natural fibre	40	40	91704
						60	91706
Ø 115 x 22.2	7,000 – 9,000	13,200	80 m/sec	Natural fibre	40	40	91714
						60	91716
Ø 125 x 22.2	6,000 – 8,000	12,200	80 m/sec	Natural fibre	40	40	91724
						60	91726
Ø 150 x 22.2	6,000 – 7,000	10,000	80 m/sec	Natural fibre	40	40	91734
						60	91736
Ø 178 x 22.2	5,000 – 6,000	8,500	80 m/sec	Natural fibre	40	40	91744
						60	91746



You can watch the **video for TRIMFIX® BLACK MAMBA®** – probably the strongest flap disc on steel – here:

<https://www.youtube.com/eisenblaettergmbh>



1 100% pure zirconium cloth
Exceptionally long service life and durability with steel and stainless steel.

2 Elastic, high-tech natural fibre compound backing plate is easy on the environment and the user (CO₂-neutral), fully self-trimmable so that the entire disc can be used, damps noise and vibration.

3 Very high amounts of abrasive

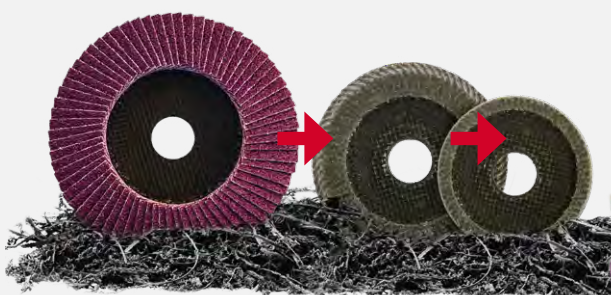

Self-trimming in the outer diameter, 100% usable fabric.

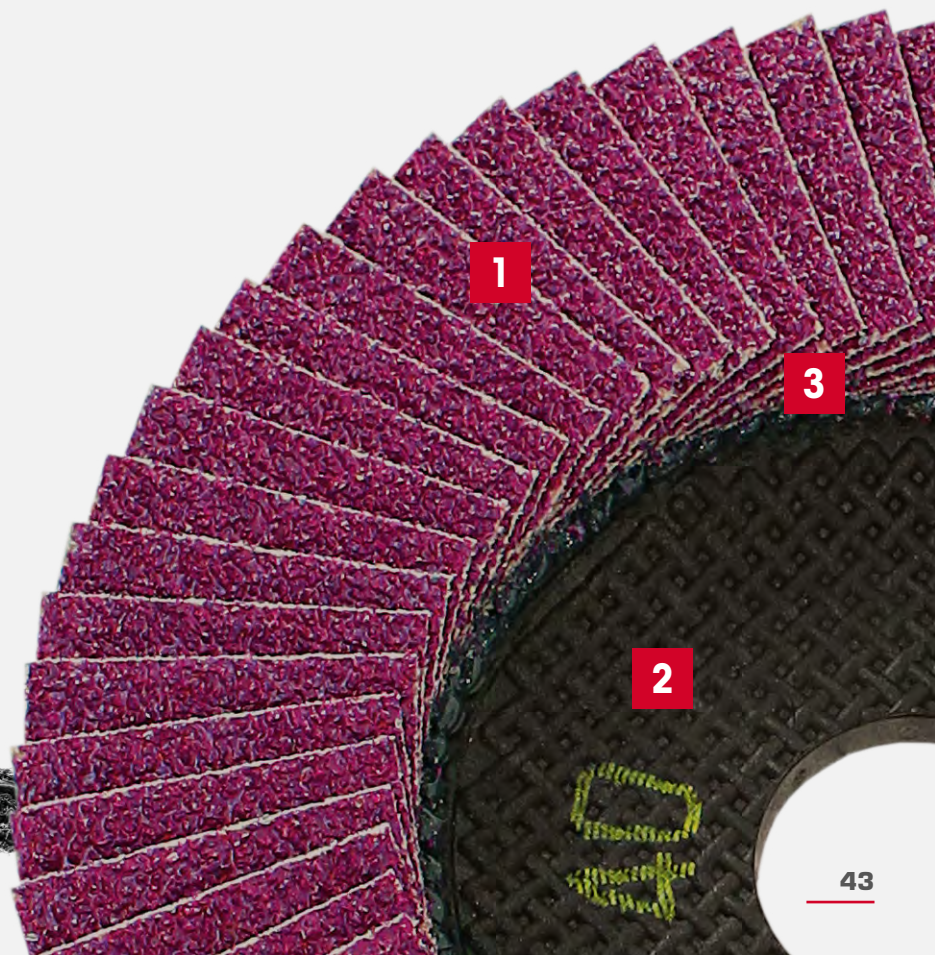

FLAP DISCS

Grinding and blending

SUITABLE FOR STEEL · STAINLESS STEEL

TRIMFIX® ZIRCOPUR®

For universal grinding work on steel and stainless steel

The quality flap disc with its revolutionary TRIMFIX® backing plate technology is equipped with **high-tech zirconium fabric** for first-rate grinding results at an unbeatable price for this superb quality.

The visco-elastic backing plate of natural fibre compound allows the disc to adapt perfectly to the work piece surface. Available in all commonly used sizes and grits, it is a universal aid you can rely on in the **medium to high power range**.

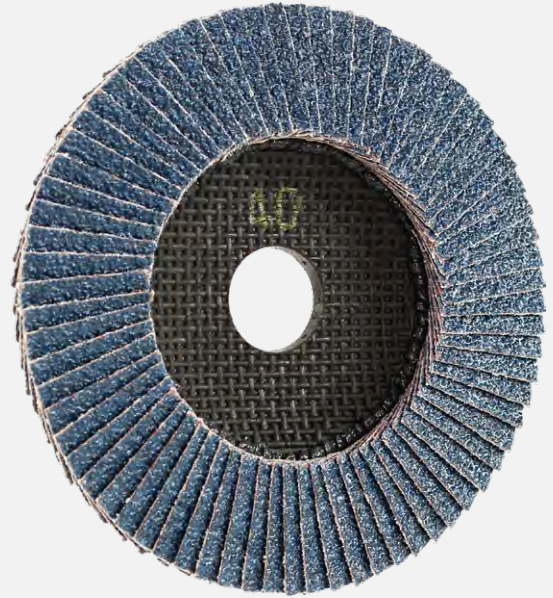

Benefits at a glance

- **High-tech zirconium cloth** for great grinding performance on steel and stainless steel.
- Very good grinding results with **unbeatable price-performance ratio**.
- **Ideal work piece adaptation ensures especially soft grinding transitions.**
- Elastic **natural fibre high-tech compound carrier plate protects the environment and users (CO₂-neutral)**, completely **self-trimmable** for complete use of the disc, **noise and vibration dampening**.



Technical specifications TRIMFIX® ZIRCOPUR® flap disc

Dimensions (mm)	Ideal speed (rpm)	Maximum speed (rpm)	Approved for (DIN EN 13743)	Backing plate	Pkg. unit 	Grit (K)	Article number
Ø 100 x 15.2	8,000 – 10,000	15,000	80 m/sec	Natural fibre	40	40	91500
						60	91501
						80	91502
						120	91503
Ø 100 x 16.0	8,000 – 10,000	15,000	80 m/sec	Natural fibre	40	40	91504
						60	91506
						80	91508
						120	91509
Ø 115 x 22.2	7,000 – 9,000	13,200	80 m/sec	Natural fibre	40	40	91514
						60	91516
						80	91518
						120	91519
Ø 125 x 22.2	6,000 – 8,000	12,200	80 m/sec	Natural fibre	40	40	91524
						60	91526
						80	91528
						120	91529
Ø 150 x 22.2	6,000 – 7,000	10,000	80 m/sec	Natural fibre	40	40	91574
						60	91576
						80	91578
						120	91579
Ø 178 x 22.2	5,000 – 6,000	8,500	80 m/sec	Natural fibre	40	40	91580
						60	91581
						80	91582
						120	91583



- 1 High-tech zirconium cloth**
Easy-to-use, cool grinding, even in continuous operation.
- 2 Elastic, high-tech natural fibre compound backing plate** is easy on the environment and the user (CO₂-neutral), fully self-trimmmable so that the entire disc can be used, damps noise and vibration.
- 3 Dimensions / grit**
Grit available in all commonly used industrial dimensions and grits.

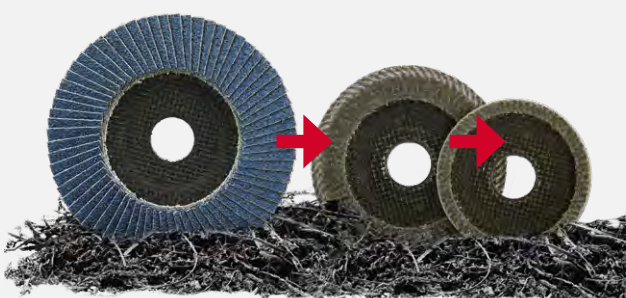

Self-trimming in the outer diameter, 100% usable fabric.

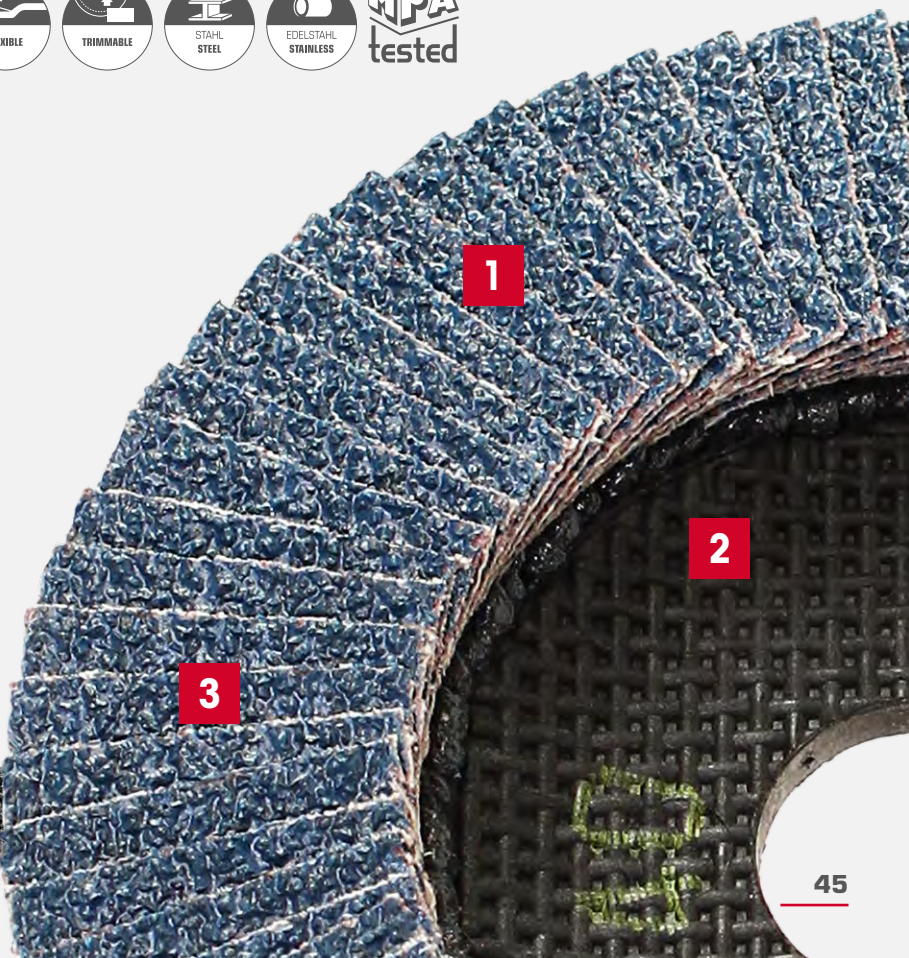

FLAP DISCS

Grinding and blending

SUITABLE FOR STEEL · STAINLESS STEEL · NON-FERROUS METALS · HARD PLASTICS

PLANTEX® Cool Top® Universal

Its 100% pure zirconium on 100% cotton cloth ensures outstanding grinding behaviour on all materials

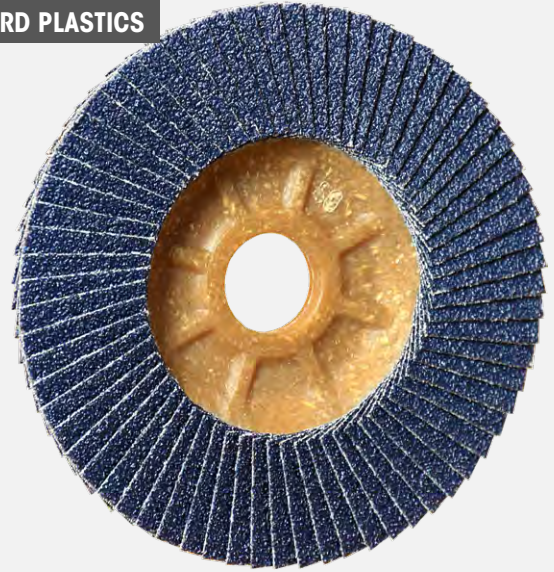

Since Eisenblätter launched the first flap disc with pure zirconium cloth for high-speed angle grinders at the end of the 1970s, it has repeatedly had innovative ideas that decisively influenced the development of the flap disc. Natural fibre compound is an ideal material for backing plates. With the development of this new manufacturing technique, PLANTEX® Cool Top® Universal became the first flap disc in the world with a backing plate of renewable hemp.

Benefits at a glance

- Conserves resources and is **environmentally friendly**.
- **Minimises pollution from manufacture to disposal**.
- **Absorbs heat** (hollow-fibre insulation reduces temperature during grinding).
- Elastic **natural fibre high-tech compound carrier plate protects the environment and users (CO₂-neutral)**, completely **self-trimmable** for complete use of the disc, **noise and vibration dampening**.
- **Easy to dispose of**.
- **Superb insulating**, damping, and noise-reducing qualities.
- High strength at **low weight**.
- Exhibits great dimensional stability while remaining **flexible**.
- **Resistant to most chemicals**.
- **Good energy-CO₂ balance**.



Technical specifications **PLANTEX® Cool Top® Universal flap disc**

Dimensions (mm)	Ideal speed (rpm)	Maximum speed (rpm)	Approved for (DIN EN 13743)	Backing plate	Pkg. unit 	Grit (K)	Article number
Ø 115 x 22.2	7,000 – 9,000	13,200	80 m/sec	Natural fibre	10	40	92140
						60	92160
						80	92180
						120	92190
Ø 125 x 22.2	6,000 – 8,000	12,200	80 m/sec	Natural fibre	10	40	92240
						60	92260
						80	92280
						120	92290
Ø 178 x 22.2	5,000 – 6,000	8,500	80 m/sec	Natural fibre	10	40	92340
						60	92360
						80	92380
						120	92390

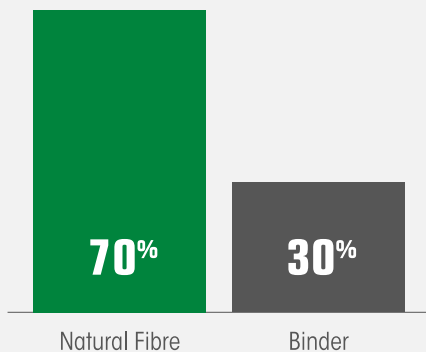

Approximate content ratio (proportions in the backing plate)

- 1** 100% pure zirconium with grinding additives on 100% cotton for an extremely wide range of applications.
- 2** Elastic, high-tech natural fibre compound backing plate is easy on the environment and the user (CO₂-neutral), fully self-trimmable so that the entire disc can be used, damps noise and vibration.

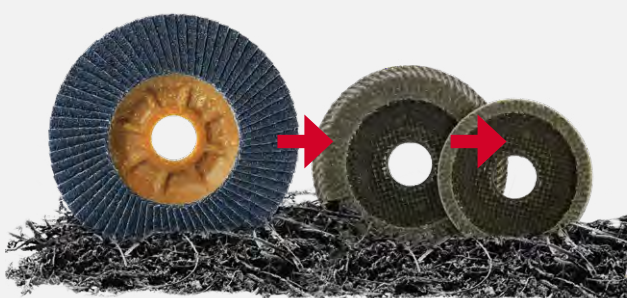

Self-trimming in the outer diameter, 100% usable fabric.

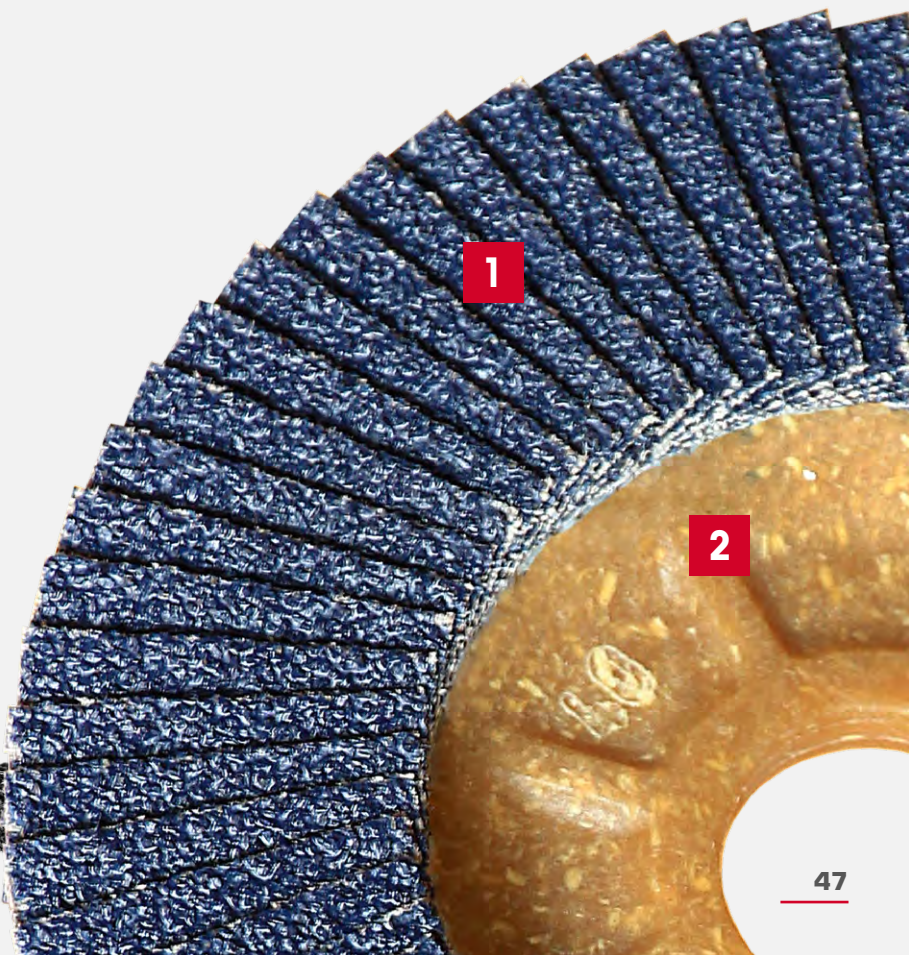

FLAP DISCS

Grinding and blending

SUITABLE FOR STEEL · STAINLESS STEEL

MAGNUM® Cool Top® 5+

The legendary, original MAGNUM® high-performance flap disc with extremely high fabric content for extremely long service life



Benefits at a glance

- **Long, quick, efficient grinding.** Has been the price-performance benchmark for years.
- The **ultra-powerful zirconium flap disc** with a backing plate of food-grade plastic.
- **Can be used universally for steel, cast iron, and stainless steel.** For surface and edge grinding, coarse and intermediate grinding, machining fillet welds, removing rust, deburring, and cleaning castings.
- In many companies, it **replaces** not only **fibre discs**, but also **rough grinding discs**.
- Backing plate of specially developed **flexible, food-grade plastic: easy to trim, damps vibration, and completely free of glass fibre.**

100% utilization of the disc by gradually trimming the backing plate



The continuous runner among flap discs!
The original – Eisenblätter's MAGNUM®.

Steel material removal in 15 minutes (steel/ST37)

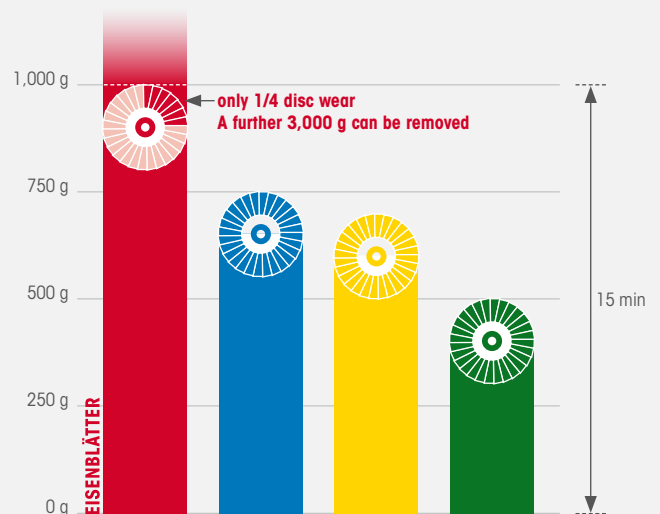

	Ø disc	Material removal in 15 minutes	Approx. maximum overall performance
■ A – top quality	125 mm	1,000 g	> 4,000 g
■ B – high quality	125 mm	750 g	2,500 g
■ C – medium quality	125 mm	650 g	1,500 g
■ D – low quality	125 mm	500 g	750 g



Technical specifications **MAGNUM® Cool Top® 5+** flap disc

Dimensions (mm)	Ideal speed (rpm)	Maximum speed (rpm)	Approved for (DIN EN 13743)	Backing plate	Pkg. unit 	Grit (K)	Article number
Ø 115 x 22.2	7,000 – 9,000	13,200	80 m/sec	Special flexible plastic	10	40	96140b
						60	96160b
						80	96180b
						120	96190b
Ø 125 x 22.2	6,000 – 8,000	12,200	80 m/sec	Special flexible plastic	10	40	96240b
						60	96260b
						80	96280b
						120	96290b
Ø 178 x 22.2	5,000 – 6,000	8,500	80 m/sec	Special flexible plastic	10	40	96340b
						60	96360b
						80	96380b



- 1** **Legendary abrasive formulation**
Pure zirconium plus cooling agent guarantees huge benefits compared to conventional flap discs:
Often up to 50% faster in removing material, many times the service life of conventional flap discs with cooler grinding due to additional cooling agents.
- 2** Backing plate made from specially developed flexible, food-grade plastic: **Easy to trim, damps vibration, and completely free of glass fibre.**
- 3** **Very high amounts of abrasive**



FLAP DISCS

Grinding and blending

SUITABLE FOR STEEL · STAINLESS STEEL

MAGNUM® Kehlnaht

Fillet Weld: High-performance flap disc with great flap overhang – a problem-solver in corners



Benefits at a glance

- For perfect **low-cost machining of corner, edge, and fillet welds.**
- The large, **flexible overhang of the abrasive flaps** over the backing plate adjusts perfectly to the shape of a fillet weld.
- **Smooth blends on corner welds.**
- Clean, **groove-free results.**
- The same grinding performance and service life as the MAGNUM® Cool Top® 5⁺.
- Backing plate of specially developed **flexible, food-grade plastic: easy to trim, damps vibration, and completely free of glass fibre.**
- **Legendary abrasive formulation** (pure zirconium plus cooling agent) guarantees **huge benefits** compared to conventional flap discs: Often up to 50% faster in removing material, many times the service life of conventional flap discs with **cooler grinding due to additional cooling agents.**

Technical specifications

Dimensions (mm)	Ideal speed (rpm)	Maximum speed (rpm)	Approved for (DIN EN 13743)	Backing plate	Pkg. unit	Grit (K)	Article number
Ø 125 x 22.2	6,000 – 8,000	12,200	80 m/sec	Special flexible plastic	10	40	96284
						60	96286
						80	96288
						120	96289

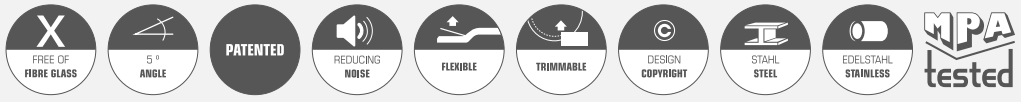

SUITABLE FOR ALL METALS

MAGNUM[®] Ceramic

Ceramic high-performance flap disc with exceptional grinding performance on all metals

High-quality ceramic product with high amounts of abrasive for an extremely long service life. Micro-crystalline grain and cooling layer increase the removal rate at reduced temperatures.



Benefits at a glance

- Advanced **high-performance ceramic disc for maximum performance.**
- **Extreme material removal rate** for stainless steel, steel, titanium, and bronze.
- **Exceptionally cool grinding behaviour** prevents discolouration.
- **Elasticity** provides damping and **noise-reducing properties.**
- Backing plate of specially developed **flexible, food-grade plastic: easy to trim, damps vibration, and completely free of glass fibre.**
- **Trimnable backing plate allows complete use** of all abrasive flaps.
- **Can be used particularly universally on different metals and hard-to-grind materials.**

Technical specifications

Dimensions (mm)	Ideal speed (rpm)	Maximum speed (rpm)	Approved for (DIN EN 13743)	Backing plate	Pkg. unit 	Grit (K)	Article number
Ø 125 x 22.2	6,000 – 8,000	12,200	80 m/sec	Special flexible plastic	10	40	96624
						60	96626
						80	96628



Eisenblätter ceramic self-sharpening process

The existing grinding force breaks off sintered micro-crystals, continuously giving the grit new, sharp cutting edges.

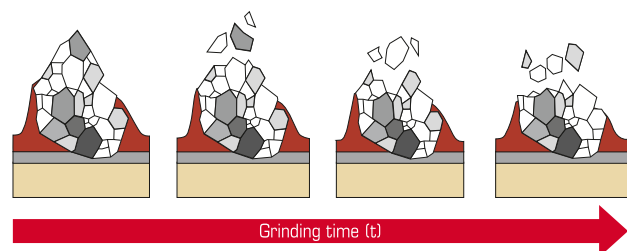

FLAP DISCS

Grinding and blending

SUITABLE FOR STEEL · CAST IRON · STAINLESS STEEL

BLUE SHARK® Elastic

Highly flexible flap disc with zirconium cooling layers for especially smooth, flat finishes, ideally suited for use in sheet metal working

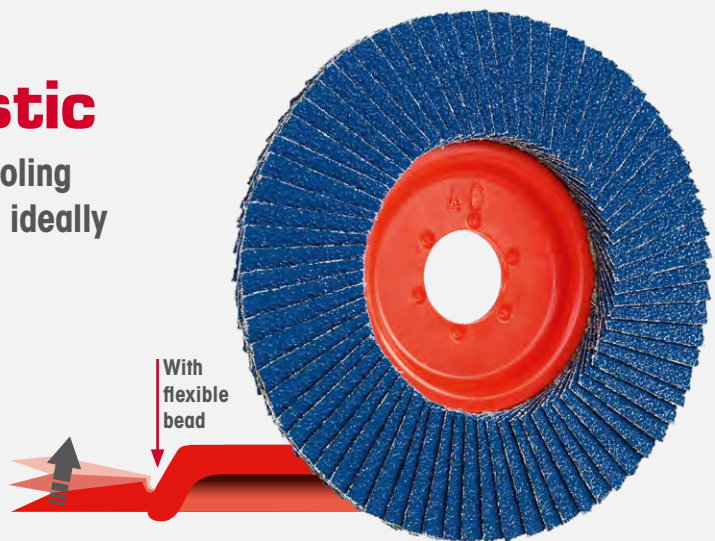
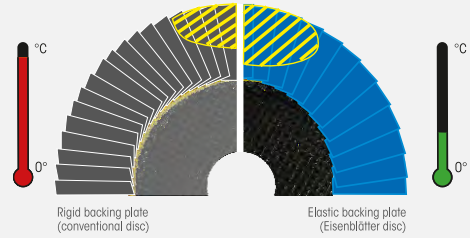

Benefits at a glance

- **Highly flexible, especially damping flap disc** with low overall height.
- For exceptionally **smooth, flat finishes** for such operations as the surface grinding of large constructions.
- The **highly flexible** backing plate allows the grinding disc to adjust ideally to the work piece surface.
- Cooler grinding behaviour makes it **ideal for sheet metal**.
- The effective **contact surface area is larger**, so heat dissipation is considerably greater. **This largely prevents work piece discolouration.**
- Backing plate of specially developed **flexible, food-grade plastic: easy to trim, damps vibration, and completely free of glass fibre.**
- Larger contact surface area ensures **much longer service life** than that of conventional flap discs.

Technical specifications

Dimensions (mm)	Ideal speed (rpm)	Maximum speed (rpm)	Approved for (DIN EN 13743)	Backing plate	Pkg. unit	Grit (K)	Article number
Ø 115 x 22.2	7,000 – 9,000	13,200	80 m/sec	Special flexible plastic	10	40	94140e
						60	94160e
						80	94180e
						120	94190e
Ø 125 x 22.2	6,000 – 8,000	12,200	80 m/sec	Special flexible plastic	10	40	94240e
						60	94260e
						80	94280e
						120	94290e
Ø 178 x 22.2	5,000 – 6,000	8,500	80 m/sec	Special flexible plastic	10	40	94340
						60	94360

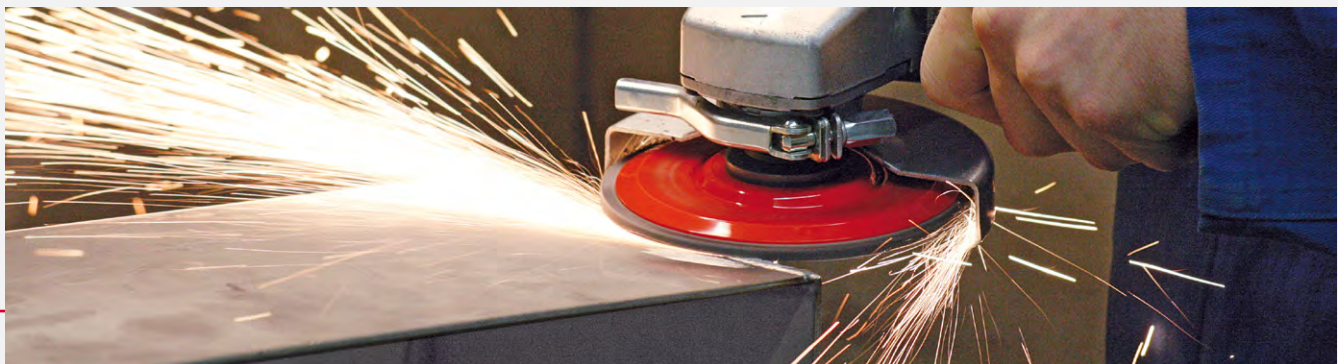

SUITABLE FOR ALUMINUM - STEEL - NON-FERROUS METALS

TIGER SHARK® Elastic

Highly flexible flap disc with cooling effect for smooth, flat grinding surfaces – ideal for machining aluminium

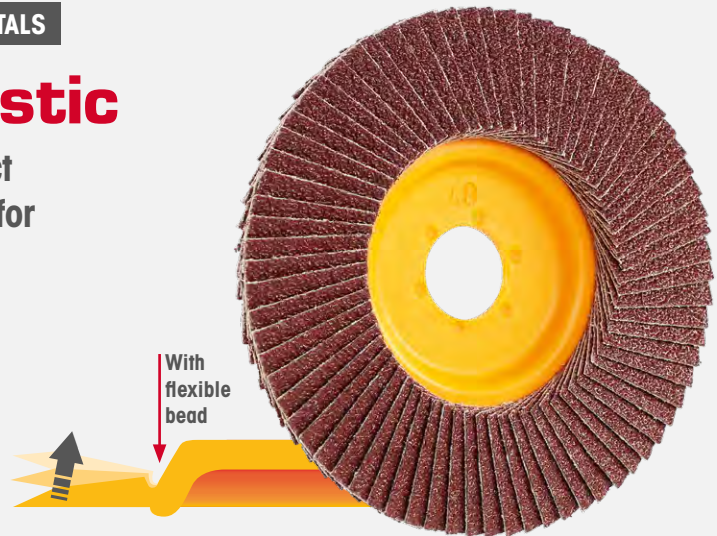
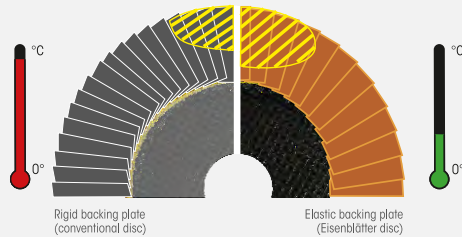

Benefits at a glance

- The special corundum abrasive cloth prevents smearing during aluminium grinding.
- TIGER SHARK® + ALU-FIX OIL deliver up to 300% more material removal and three times the service life.
- Visibly improved grinding results.
- The highly flexible backing plate allows the grinding disc to adjust ideally to the work piece surface.
- Machining trimming enables use down to the last millimetre.
- High grinding performance at low tool costs.
- High material removal capacity at reduced grinding temperature.
- Ideal for curved surfaces and shaped pieces such as those encountered in car bodywork, motor vehicle workshops, and railway carriage and tool construction.
- Backing plate of specially developed flexible, food-grade plastic: easy to trim, damps vibration, and completely free of glass fibre.

Technical specifications

Dimensions (mm)	Ideal speed (rpm)	Maximum speed (rpm)	Approved for (DIN EN 13743)	Backing plate	Pkg. unit	Grit (K)	Article number
Ø 115 x 22.2	7,000 – 9,000	13,200	80 m/sec	Special flexible plastic	10	40	94114
						60	94116
						80	94118
						120	94119
Ø 125 x 22.2	6,000 – 8,000	12,200	80 m/sec	Special flexible plastic	10	40	94124
						60	94126
						80	94128
						120	94129
Ø 178 x 22.2	5,000 – 6,000	8,500	80 m/sec	Special flexible plastic	10	40	94134
						60	94136



TIGER SHARK® + ALU-FIX Oil
Results in up to 300% more removal rate and a service life that is up to 3 times longer (see page 223)

FLAP DISCS

Grinding and blending

SUITABLE FOR STEEL · STAINLESS STEEL · CAST IRON · NON-FERROUS METALS · ALUMINUM

ZIRCOTEX® Nylon Plan

The legendary flat flap disc – ideal for levelling weld seams on flat surfaces

Ideal for rough grinding, smoothing and leveling weld seams on flat surfaces and outer edges. Thanks to the wide double lamellas, the heat is distributed over the entire area and thus increases the cooling effect during grinding. The zircon fabric is versatile, so steel, stainless steel and cast iron can be processed just as well as non-ferrous metals and aluminum.



Benefits at a glance

- **Extremely wide zirconium double flaps** (30 mm at Ø 115 mm) improve heat distribution and enhance the cooling effect.
- **Service life is around 50 times that of conventional corundum fibre discs.**
- For **rough grinding, smoothing, and cleaning weld seams and spot welds.**
- **Very large abrasive surface for a long service life.**
- **Flat contact area for perfect weld blending on outer edges** (weld seam edges).
- Ideal for **flat surfaces**, switch cabinet construction, and welding assemblies.
- Suitable as replacement disc for ROLEI EF 115 deburring devices (page 202).

Technical specifications

Dimensions (mm)	Ideal speed (rpm)	Maximum speed (rpm)	Approved for (DIN EN 13743)	Backing plate	Pkg. unit 	Grit (K)	Article number
Ø 115 x 22.2	7,000 – 8,000	13,200	80 m/sec	Polyamide plastic	10	40	21040
						50	21050
						60	21060
						80	21080
						120	21120

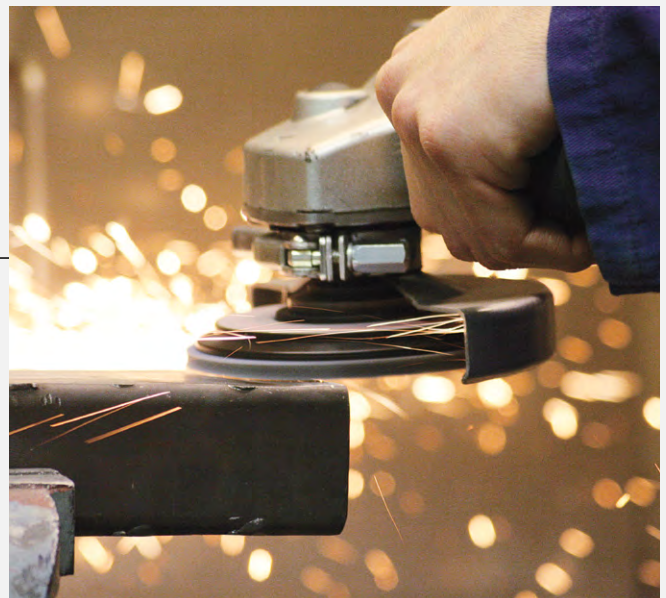
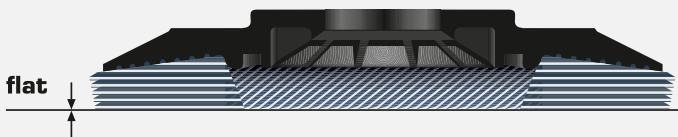

SUITABLE FOR ALL METALS

Flap Disc Test Box

This is where you can find the ideal grinding disc for your individual application











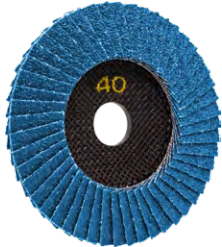

The ten best high-tech flap discs in a single box, including sales documents.



Technical specifications

Product description	Pkg. unit 	Article number
Test box including 10 different high-tech grinding discs	1	99316
Contents:		
1 TRIMFIX® ZIRCOPUR® 125 x 22.2 mm, grit 40	1 PLANTEX® Cool Top® Universal 125 x 22.2 mm, grit 40	
1 TRIMFIX® BLACK MAMBA® 125 x 22.2 mm, grit 40	1 BLUE SHARK® Elastic 125 x 22.2 mm, grit 40	
1 TRIMFIX® HellFire® 125 x 22.2 mm, multigrain 40/60	1 TIGER SHARK® Elastic 125 x 22.2 mm, grit 40	
1 TRIMFIX® SteelFire® 125 x 22.2 mm, grit 40	1 MAGNUM® Cool Top® 5+ 125 x 22.2 mm, grit 40	
1 TRIMFIX® MUSTANG 125 x 22.2 mm, grit 40	1 MAGNUM® Kehlnaht 125 x 22.2 mm, grit 40	

These Eisenblätter top quality flap discs are included in the test box:

<p>TRIMFIX® ZIRCOPUR®</p>  <p>page 44</p>	<p>TRIMFIX® BLACK MAMBA®</p>  <p>page 42</p>	<p>TRIMFIX® HellFire®</p>  <p>page 38</p>	<p>TRIMFIX® MUSTANG</p>  <p>page 36</p>	<p>TRIMFIX® SteelFire®</p>  <p>page 40</p>
<p>MAGNUM® Kehlnaht</p>  <p>page 50</p>	<p>PLANTEX® Cool Top® Universal</p>  <p>page 46</p>	<p>BLUE SHARK® Elastic</p>  <p>page 52</p>	<p>TIGER SHARK® Elastic</p>  <p>page 53</p>	<p>MAGNUM® Cool Top® 5+</p>  <p>page 48</p>
				

FIBRE DISCS

Grinding and blending

SUITABLE FOR ALL METALS

COLDSTEEL® RazorFlap® Grinding Disc

The best of fibre and flap discs!

Completely new and **patented high-performance flap discs** guarantee metal removal rates that were previously not achievable with commercially available flap discs.

The **COLDSTEEL® RazorFlap®** disc was specially developed for the **heavy-duty area**, such as in **shipyards and shipbuilding, metal, structural and civil engineering** etc.; where it is a matter of processing or carrying out **large weld seams, chamfers, deburring and much more at record speed**. This ingenious new development represents an ingenious **combination of flap disc and ceramic fibre disc**, which combines durability and grinding performance of both systems. **Removal increases of 30 to 40%**, e.g. compared to ceramic flap discs are achieved on average. The **flat arrangement** of the lamellae and the **wide contact surface** enable a **high grinding speed on all metals** that were previously only known from **cubic ceramic fibre discs**. Similar to a flap disc, the lamellae are completely used up at the edge of the lamellae and **provide fresh grain**. Due to these polishing properties of the carrier fabric, **significantly lower roughness depths** are achieved on the surface of the work piece. This means that **post-processing** with subsequent tools **can often be dispensed with**.

The **COLDSTEEL® RazorFlap®** has been equipped with a **new generation of micro-crystalline ceramic grains** which, in addition to their **particularly cooling properties**, retain their **high grinding sharpness** over the **entire service life**. The new discs have a **fibreglass-free natural fibre compound backing plate with an M14 thread** and can be changed at lightning speed without tools. The **COLDSTEEL® RazorFlap®** **saves** enormously cost-intensive **working time**, especially when it comes to reducing metal mass quickly!



Recommendation:

Due to the extreme performance of these discs, we only recommend using particularly high-torque angle grinders, such as VARILEX® 1802 HT (High Torque) or corresponding grinders – see page 16!

Benefits at a glance

- **3 to 4 times longer service life** than ceramic fibre discs.
- **30 to 40% higher stock removal rate** compared to conventional, ceramic flap discs.
- **Consistent grinding sharpness over the entire service life.**
- Elastic **natural fibre high-tech compound carrier plate protects the environment and users (CO₂-neutral)**, completely **self-trimmable** for complete use of the disc, **noise and vibration dampening**.
- With **integrated M14 thread** for tool-free and fastest tool changes.





Technical specifications **COLDSTEEL® RazorFlap®** grinding disc

Dimensions (mm x mount)	Ideal speed (rpm)	Maximum speed (rpm)	Approved for (DIN EN 13743)	Backing plate	Pkg. unit 	Grit (K)	Article number
Ø 125 x M14	6,000 – 8,000	12,200	80 m/sec	Natural fibre	5	36	82211



- 1 Elastic natural fibre high-tech compound carrier plate** protects the environment and the user (CO₂-neutral), completely self-trimmmable for 100 percent use of the disc, noise and vibration dampening.
- 2 High-performance ceramic fabric** for maximum stock removal and cool grinding.
- 3 Patented lamella configuration for consistently high removal rates over the entire service life.**

Eisenblätter ceramic self-sharpening process

The existing grinding force breaks off sintered micro-crystals, continuously giving the grit new, sharp cutting edges.

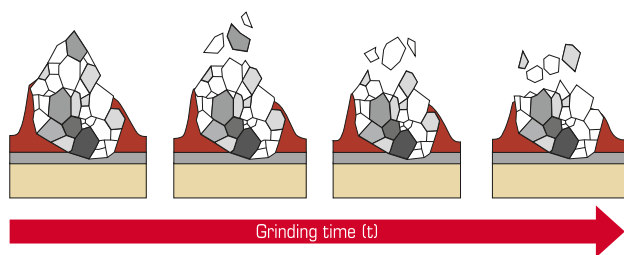

FIBRE DISCS

Grinding and blending

SUITABLE FOR STEEL · STAINLESS STEEL

COLDSTEEL®

Ceramic fibre disc

Micro-crystalline abrasive grain creates **additional, new abrasive edges during grinding**, which significantly increases the removal rate compared to conventional fiber discs.

Advantage over pyramid ceramics:

Despite high performance, **smoother surfaces** and therefore **less rework** on the workpiece. In addition, **drive motors are significantly protected.**



Benefits at a glance

- **Top ceramic quality!**
- Ultra-fine grit and crystal structures ensure significantly **more self-sharpening edges and greatly improved material removal.**
- **Self-sharpening ceramic grit.**
- The finer grinding results on the work piece surface **reduces the frequent necessity of reworking** the piece with finer grits.
- Even in the **coarse grit range**, at a **high rate of material removal**, the **size of the chip particles** remains relatively **small, preventing** damage from the **afterglow effect** of large metal particles.
- The universal high-performance fibre disc with an especially great cooling agent content is easy on any drive motor.

Technical specifications

Dimensions (mm)	Approved for (DIN EN 13743)	Pkg. unit 	Grit (K)	Article number
Ø 115 x 22.2	80 m/sec	25	36	82004
			60	82007
			80	82008
			120	82009
Ø 125 x 22.2	80 m/sec	25	24	82013
			36	82014
			60	82017
			80	82018
			120	82019
Ø 180 x 22.2	80 m/sec	25	24	82023
			36	82024
			60	82027
			80	82028
			120	82029



COLDSTEEL® – the Eisenblätter ceramic self-sharpening process

The existing grinding force breaks off sintered micro-crystals, continuously giving the grit new, sharp cutting edges.

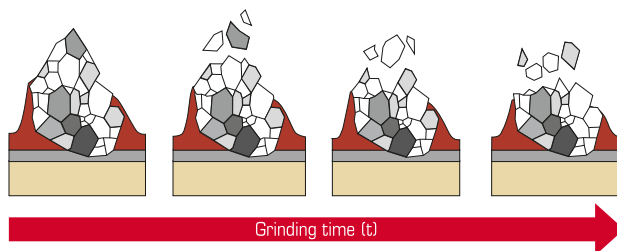

SUITABLE FOR FIBRE DISCS

COLDSTEEL® Backing Pad

Specially developed heat-resistant backing pad for fibre discs. The ribs on the underside dissipate heat, effectively preventing heat build-up and discolouration.



Benefits at a glance

- **Heat-resistant plastic** with a high fibre content for dimensional stability, even during continuous use.
- **Aluminium locking nut – no rust:** Aluminium alloy locking nuts prevent iron particle contamination of stainless steel when metals make contact.

Technical specifications

Dimensions (mm)	Mount	Maximum speed (rpm)	Approved for (DIN EN 13743)	Pkg. unit 	Article number
Ø 113	M14 thread	13,200	80 m/sec	1	82001
Ø 123	M14 thread	12,200	80 m/sec	1	82011
Ø 173	M14 thread	8,500	80 m/sec	1	82021

5/8" threads upon request.

VARILEX® ANGLE POLISHERS

Mains powered machines

SUITABLE FOR ROUGH GRINDING TO POLISHING

VARILEX® POLISHER HT

Durable powerhouse

Because of the high braking effect involved, polishing work is among the most challenging types of work for any drive motor. With its newly developed drive motor with planetary gear, Eisenblätter offers an unparalleled range of torque and performance. The distribution of power across three additional transmission gear wheels allow torques under full load that conventional single transmissions of comparable size cannot achieve.



Benefits at a glance

- **Powerful motor (1,750 W) and new transmission mechanics** (high torque) for wear-resistant power transmission.
- Enormous power density despite the compact design: **Extremely powerful and robust one-hand polisher** (for disc up to Ø 180 mm) – 100% made in Germany.
- Eminently suitable for **cleaning, fine grinding, and polishing of stainless steel and non-ferrous metals**, for the FIX HOOK & LOOP system and, with an adapter, for the MINI FIX HOOK & LOOP system.
- **Balanced and vibration-damping handle** reduces strain on the user.
- **Infinitely adjustable speed from 820 to 3,000 rpm** with a tacho-generator for constant speed, even under load.
- Rubberised, **ultra-ergonomic shaft handle** ensures outstanding handling and sensitivity during work.
- **Elastic rubber ball handle** for optimum polishing handling and reduced strain on the user.

Polishing of the life-size bronze sculpture of the ancient god Kairos by the Geretsried artist Bruno Wank

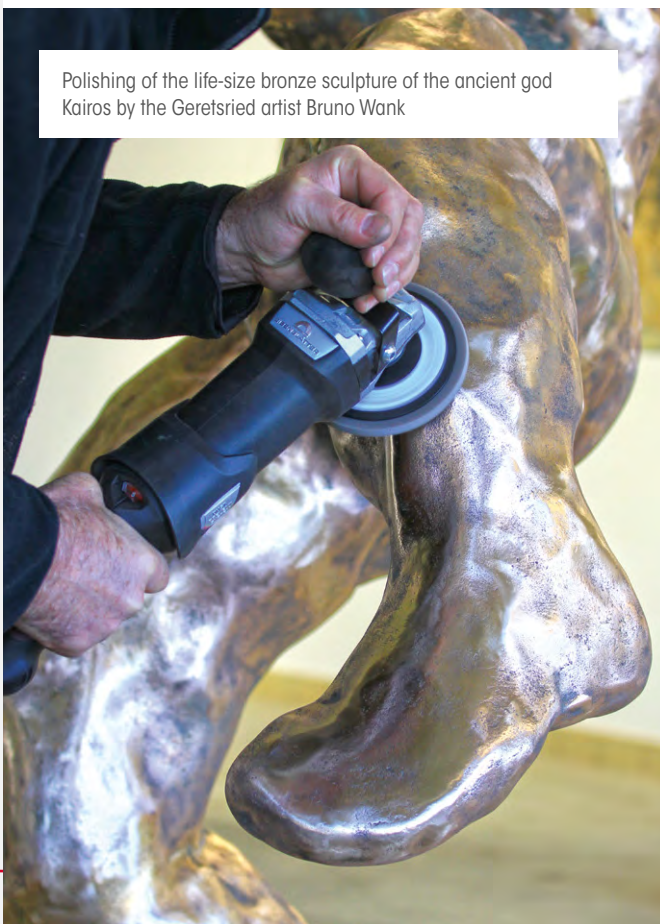

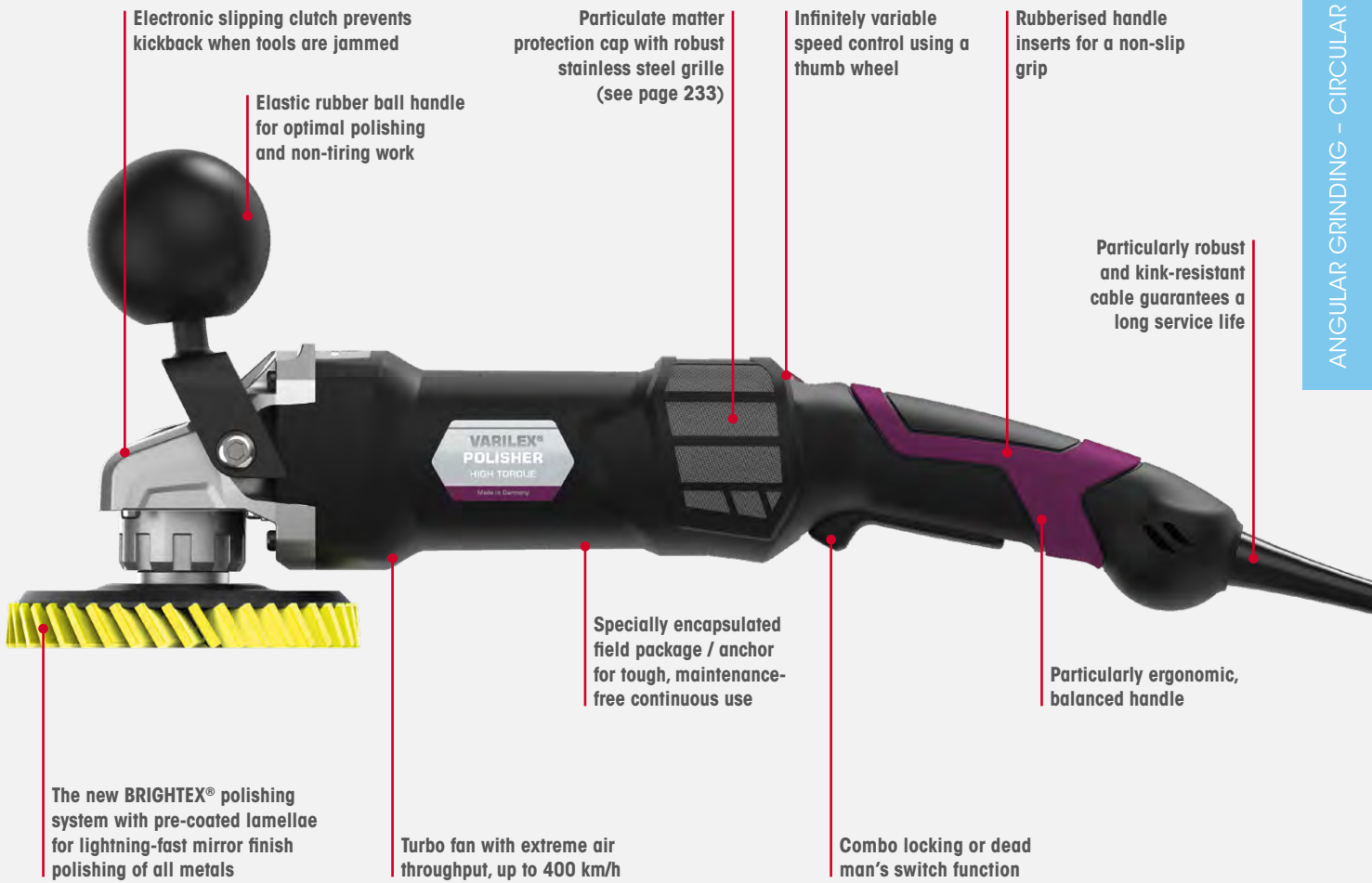

Technical specifications VARILEX® POLISHER HT basic set

Plug type	Cable type	Mains connection (V - Hz)	Power (W)	Mount	Speed (rpm)	Weight (kg)	Pkg. unit 	Article number
EU (C+F)	Permanent connection	220 - 240 ~ 50 - 60	1,750	M14 thread	820 - 3,000	2.99	1	65051
GB (G)	Permanent connection	110 - 240 ~ 50 - 60	1,750	M14 thread	820 - 3,000	2.99	1	65051a

- Contents:**
- 1 VARILEX® POLISHER HT basic device with rubber ball handle
 - 1 Robust, impact-resistant plastic case
 - 1 Particulate matter protection cap
 - 1 Support flange
 - 1 Clamping nut
 - 1 Chuck key
 - 2 BRIGHTEX® FLAP polishing discs

Please note: Practical accessory set see page 64.



A **high-quality planetary gear** has been designed for grinding machines in the low speed range. It ensures wear-resistant power transmission with enormous additional torque.

The ideal addition to your machine: **VARILEX® POLISHER accessory set** (see page 64)



We recommend our **BRIGHTEX®** products (from page 215) for a lightning-fast mirror finish in just a few steps.

VARILEX® ANGLE POLISHERS

CAS cordless machines

SUITABLE FOR ROUGH GRINDING TO POLISHING

VARILEX® POLISHER AKKU

High-performance one-handed polisher

The planetary gear and 18 V provides especially great torque and pulling power even with very long running times. Soft handle is the first to allow ideal handling in all working positions. Ideal for the BRIGHTEX® mirror finish polishing system, finishing and fine grinding work and cleaning discs.



Benefits at a glance

- **Powerful motor (18 V) and new transmission mechanics (high torque)** for wear-resistant power transmission. This is approx. 1,600 watts of power.
- Enormous power density despite the compact design: **Extremely powerful and robust one-hand polisher** – 100% made in Germany.
- **Balanced and vibration-damping rubber ball handle** reduces strain on the user.
- **Available for the first time with planetary gear**, giving it the power of a plug-in machine of ~1,600 watts.
- **Optimised speed of 1,600 rpm** with a tacho-generator and planetary gear for constant speed, even under load.
- Eminently suitable for **cleaning, fine grinding, and polishing of stainless steel and non-ferrous metals**, for the FIX HOOK & LOOP system and, with an adapter, for the MINI FIX HOOK & LOOP system.



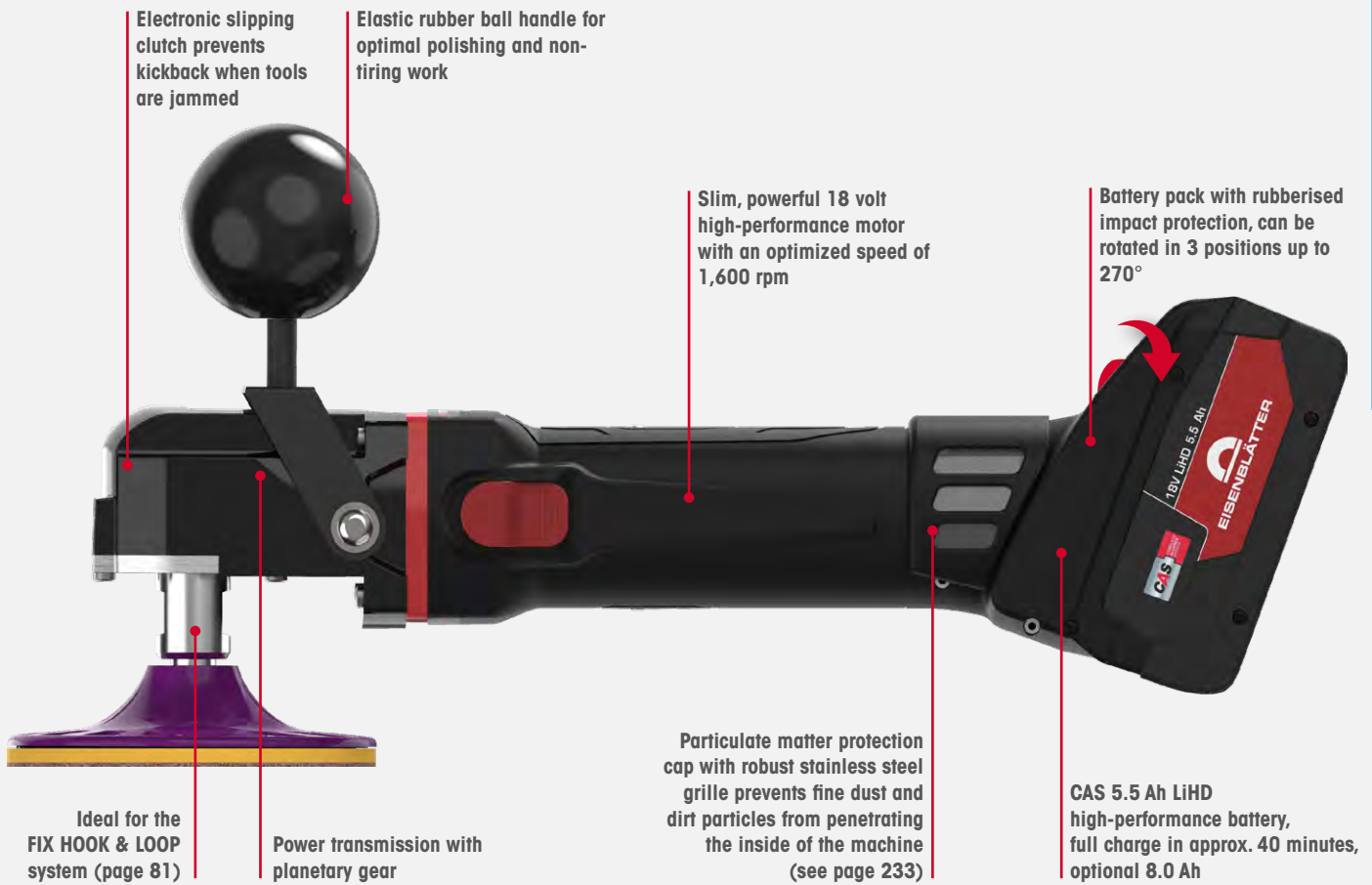

Technical specifications VARILEX® POLISHER AKKU basic set / basic device (without CAS batteries, charger & accessories)

Item	Plug type	Cable type	Mains connection (V - Hz)	Power (V)	Mount	Speed (rpm)	Weight (kg)	Pkg. unit	Article number
Basic set	EU (C+F)	Permanent connection	220 – 240 – 50 – 60	18	M14 thread	1,600	2.1	1	65061
Basic device	EU (C+F)	Permanent connection	220 – 240 – 50 – 60	18	M14 thread	1,600	2.1	1	65062

Scope of delivery

VARILEX® POLISHER AKKU basic set:

- 1 VARILEX® POLISHER AKKU basic device
- 1 Robust, impact-resistant plastic case
- 1 Particulate matter protection cap
- 2 LiHD batteries 18 volts with 5.5 Ah capacity (CAS)
- 1 Fast charger incl. cable (CAS)
- 1 Support flange
- 1 Clamping nut
- 1 Chuck key
- 2 BRIGHTEX® FLAP polishing discs



Scope of delivery

VARILEX® POLISHER AKKU basic device:

- 1 VARILEX® POLISHER AKKU basic device
- 1 Robust, impact-resistant plastic case
- 1 Support flange
- 1 Clamping nut
- 1 Chuck key



Please note: Practical accessory set see page 64, batteries and chargers see page 229.

Attention: No battery and no charger included!

One battery, many solutions. Cross-brand. 100% Compatibility.



VARILEX® ANGLE POLISHERS

Accessory sets

SUITABLE FOR VARILEX® POLISHER HT · VARILEX® POLISHER AKKU

VARILEX® POLISHER Accessory Set

27
TEILE
PARTS

This accessory set is the ideal addition to the VARILEX® POLISHER. Whether you want to smooth a weld seam or need a perfect mirror finish, this set provides everything you need, including surface cleaning and sealing agent. All packed neatly in a robust, impact-resistant plastic case.

Technical specifications

Application	Can be used with	Pkg. unit 	Article number
Fine grinding to a perfect mirror finish	VARILEX® POLISHER HT, VARILEX® POLISHER AKKU	1	65052

Contents:

- | | |
|--|---|
| <ul style="list-style-type: none"> 1 Mobile tool case 3 Fleece Flap Ø 125 mm 1 FIX HOOK & LOOP backing pad Ø 150 mm 4 FIX HOOK & LOOP Trizact™ Ø 150 mm 2 FIX HOOK & LOOP AluPolish Ø 150 mm 2 BRIGHTEX® FLAP polishing discs Ø 125 mm | <ul style="list-style-type: none"> 6 FIX HOOK & LOOP BRIGHTEX® polishing discs Ø 150 mm 2 BRIGHTEX® mini polishing pastes 1 BRILLIANCE CLEAN 50 ml 1 POWER CLEANER 50 ml 1 INOX PROTECT 50 ml 2 BRIGHTEX® microfibre cloths 1 BRIGHTEX® Softclean Powder |
|--|---|



The ideal supplement for these VARILEX® angle polishers:



VARILEX® POLISHER HT

p. 60



VARILEX® POLISHER AKKU

p. 62



SUITABLE FOR ALL METALS

MAGNUM® Poly Magic Wheel

The revolution for mirror-finish polishing in corners



Application:

1. **Pre-polish** and level fine weld seams with the MAGNUM® Poly Magic Wheel, **A grit**.
2. **Polish** to a flawless mirror finish with the MAGNUM® Poly Magic Wheel, **B grit**.

Benefits at a glance

- For **fine grinding and mirror-finish polishing** in corners.
- Saves lots of working time and **replaces expensive manual labour**, particularly in balustrade and hand-rail production, which often involves corner welds.
- **Produces a flawless mirror finish in just two steps without polishing pastes or creams.**
- Can be used on many variable-speed angle grinders / polishers.
- Backing plate of specially developed **flexible, food-grade plastic: easy to trim, damps vibration, and completely free of glass fibre.**
- New formulation:**
- Highly compressed fleece disc for **greatly extended service life.**
- **Now it can also be used on flat surfaces.**
- Machine recommendation:**
- VARILEX® POLISHER HT, see page 60.

Technical specifications

Dimensions (mm)	Ideal speed (rpm)	Maximum speed (rpm)	Material thickness (mm)	Backing plate	Ideal for	Application	Pkg. unit 	Article number
Ø 165 x 22.2	3,000 – 4,000	5,700	6	Special flexible plastic	Angle grinders with variable speed	Pre-polishing (A)	5	96720
						Polishing (B)	5	96721



FINE GRINDING DISCS

Finishing and fine grinding

SUITABLE FOR ALL METALS · WOOD · HARD PLASTICS

MAGNUM® DecoFinish

New compact fleece with sensational, revolutionary properties



The open-pore design achieves **especially fine, decorative results on all metals**, hard plastics, and wood. Fine weld seams, spot welds, and deep scratches can be directly removed at the same time, depending on contact pressure. The especially fine finish allows an immediate perfect mirror finish with polishing discs such as those from the BRIGHTEX® polishing system if needed. This **avoids time-consuming intermediate grinding and polishing steps**. Even paint layers with filler on vehicle body parts can be ground down to bare metal. This metal is given a top finish and can immediately be re-painted.

With MAGNUM® DecoFinish, rust and oxide layers are no hindrance to a perfect final finish, either. This new compact fleece can be used **for a variety of applications**. It is extremely tough and durable, does not clog pores, and has damping, cooling properties that allow perfect work piece adaptation and soft grinding transitions.

The MAGNUM® DecoFinish is certainly one of the most modern compact fleece designs on the global market.

Benefits at a glance

- **Homogeneous and decorative result in one operation.**
- **Outstanding for all metals** (stainless steel, steel, non-ferrous metals, etc.) and for hard plastic and wood.
- **Achieves the finest grinding results while smoothing scratches, minor weld seams, and spot welds.**
- **Removes paint, rust, and oxide perfectly while achieving a top quality finish.**
- Open-pored, tough **compact fleece with a long service life does not smear** even on paints and varnishes.
- **Cool grinding behaviour prevents discolouration.**
- **Perfect workpiece adaptation** thanks to **highly elastic properties**, resulting in significantly **improved surface grinding** compared to conventional discs.
- **Integrated M14 threads** ensure simple, fast, convenient disc change.
- Elastic **natural fibre high-tech compound carrier plate protects the environment and users (CO₂-neutral)**, completely **self-trimmable** for complete use of the disc, **noise and vibration dampening**.

Perfect adaptation to the workpiece thanks to the visco-elastic properties of the grinding cloth and the elasticity of the natural fibre backing plate





Removes scratches and small spot welds and seams all at the same time.



Ideal for pre-polishing.



Removes paint while achieving a surface finish.



Subsequent mirror finish polish with the BRIGHTEX® polishing system (Berry + Sun). See the polishing section starting on page 214.



Result: raw to perfect mirror finish in two to three steps – also ideal for round pipes.

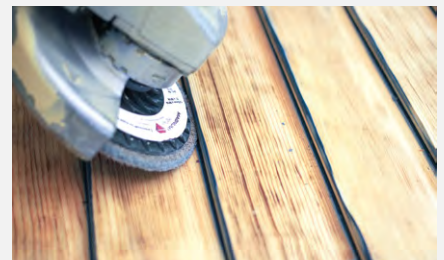

Also suitable for processing wood.

Technical specifications **MAGNUM® DecoFinish grinding disc**

Dimensions (mm)	Ideal speed (rpm)	Maximum speed (rpm)	Approved for	Material thickness (mm)	Backing plate	Ideal for	Pkg. unit 	Article number
125 mm x M14	2,000 – 4,000	4,500	30 m/sec	13	Natural fibre	Angle grinders with variable speed	5	96725



- 1** Full-surface, open-pore special fleece: **Outstanding for all metals!**
- 2** Elastic, high-tech natural fibre compound backing plate is easy on the environment and the user (CO₂-neutral), fully self-trimmable so that the entire disc can be used, damps noise and vibration.

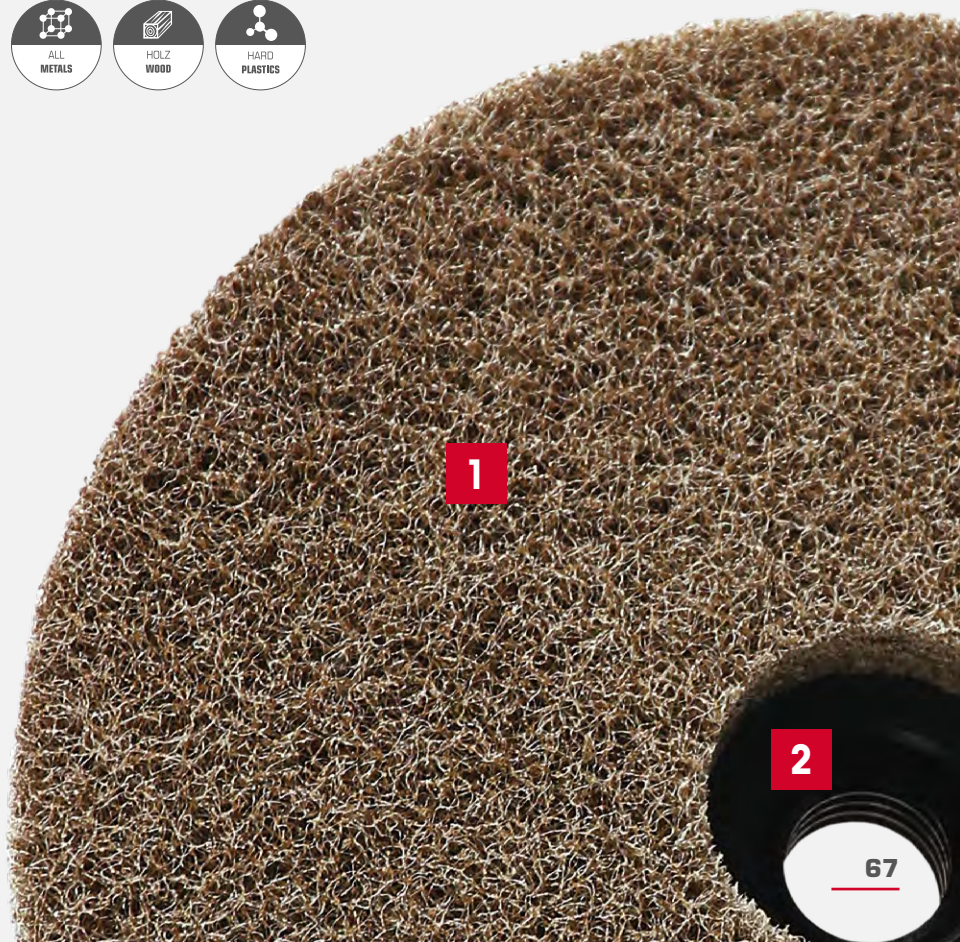

FINE GRINDING DISCS

Finishing and fine grinding

SUITABLE FOR ALL METALS · WOOD

TRIMFIX® Fleece Flap 1FOR2

Only from Eisenblätter:
1FOR2 extra-coarse grit

The 1FOR2 extra-coarse (green) grit's ceramic grit content allows easy removal of thin weld seams and spot welds at the same time.



Benefits at a glance

- **Highly flexible, damping fleece flap disc** with low overall height.
- High-quality surface conditioning (SC) fleece material for an **extremely long service life**.
- Ideal for the preparation of a later high and mirror finish of stainless steel.
- Large effective contact surface area for **greater heat dissipation**.
- **Ideal for rounding off internal edges.**
- Elastic **natural fibre high-tech compound carrier plate protects the environment and users (CO₂-neutral)**, completely **self-trimmable** for complete use of the disc, **noise and vibration dampening**.

Technical specifications

Dimensions (mm)	Ideal speed (rpm)	Maximum speed (rpm)	Approved for (DIN EN 13743)	Ideal for	Backing plate	Pkg. unit	Grit (fleece)	Grit (K)	Colour (fleece)	Article number
Ø 125 x 22.2	2,000 – 5,000	12,200	80 m/sec	Angle grinders with variable speed	Natural fibre	10	1FOR2 extra-coarse	40	green	96740



The 1FOR2 extra-coarse (green) grit allows removal of thin weld seams and spot welds.

SUITABLE FOR ALL METALS · WOOD

TRIMFIX® Fleece Flap

Highly elastic SC fleece flap disc – ideal fine machining of weld seams



Benefits at a glance

- **Highly flexible, damping fleece flap disc** with low overall height.
- High-quality surface conditioning (SC) fleece material for an **extremely long service life**.
- Ideal for the preparation of a later high and mirror finish of stainless steel.
- Large effective contact surface area for **greater heat dissipation**.
- **Ideal for rounding off internal edges.**
- In all grit grades from fine grinding to matt sheen.
- Elastic **natural fibre high-tech compound carrier plate protects the environment and users (CO₂-neutral)**, completely **self-trimmable** for complete use of the disc, **noise and vibration dampening**.

Technical specifications

Dimensions (mm)	Ideal speed (rpm)	Maximum speed (rpm)	Approved for (DIN EN 13743)	Ideal for	Backing plate	Pkg. unit 	Grit (fleece)	Grit (K)	Colour (fleece)	Article number
Ø 125 x 22.2	2,000 – 5,000	12,200	80 m/sec	Angle grinders with variable speed	Natural fibre	10	coarse	80	brown	96741
							medium	180	red	96742
							fine	280	blue	96743



For deburring, fine grinding, pipe finishing, TIG, weld grinding, and intermediate grinding.



FINE GRINDING DISCS

Finishing and fine grinding

SUITABLE FOR ALL METALS · WOOD · HARD PLASTICS

MAGNUM® Fleece Top

Versatile fleece disc manufactured from foamed, compressed grinding fleece for fine finishes

For metalworking jobs such as grinding, fine grinding, smoothing and polishing and removing oxides, scratches, rust, burrs and paint. Also cleans and smooths wood and plastics.



Benefits at a glance

- **Up to 8 times the service life** of conventional fleece discs.
- The special **self-cleaning fleece mixture prevents clogging and smearing**.
- Replaces wire brushes, sandpaper and rubber grinding wheels.
- Also ideal for **cleaning and smoothing metal, wood, and plastic**.
- **Consistently clean grinding pattern thanks to elasticity.**
- **Perfect for smoothing tool surfaces.**
- Backing plate of specially developed **flexible, food-grade plastic: easy to trim, damps vibration, and completely free of glass fibre.**
- Its 30-mm-wide silicon carbide fleece ring **significantly extends its service life!**





Stainless steel: Cleaning, removing minor scratches, Preparation for pickling (max. speed 2,500 rpm)



Steel: Fine grinding, deburring, rust removal



Aluminium: Cleaning, fine grinding



Wood: Smoothing wood fibre
Please Note: Paint and varnish can be removed beforehand with Eisenblätter CLEAN discs (see page 74) products.

Technical specifications **MAGNUM® Fleece Top grinding disc**

Dimensions (mm)	Ideal speed (rpm)	Maximum speed (rpm)	Material thickness (mm)	Backing plate	Ideal for	Pkg. unit 	Grit (K)	Article number
Ø 115 x 22.2	2,000 – 5,000	8,000	15	Special flexible plastic	Angle grinders with variable speed	5	80	96710
							180	96711
							280	96712
							400	96713
							600	96714
							900	96715



Roughness depth values:

Average roughness depth for stainless steel	80	180	280	400	600	900
Rz in µ	6.10 µ	4.16 µ	2.78 µ	2.74 µ	2.26 µ	1.66 µ

Average roughness depth for aluminium	80	180	280	400	600	900
Rz in µ	9.26 µ	5.63 µ	3.85 µ	3.78 µ	2.68 µ	2.58 µ

Rz = average roughness depth value

- 1** The special **self-cleaning fleece** mixture prevents clogging and smearing.
- 2** Perfect for smoothing tool surfaces.



FINE GRINDING DISCS

Finishing and fine grinding

SUITABLE FOR ALL METALS · WOOD

MAGNUM® Top Mix

Combination fleece disc – complete 2 operations at once, high material removal with fine grinding results



The coordinated combination of abrasive flaps alternating with compressed fleece produces a much better grinding performance, longer service life, and fine grinding results. For preparatory grinding and fine grinding of spot welds and deep scratches on stainless steel, steel and non-ferrous metals, also great for finely deburring perforated sheet metal and reworking corners.

Benefits at a glance

- Intermediate A/O grit layers make these discs **significantly more aggressive than conventional fleece discs.**
- The coordinated combination of abrasive flaps alternating with compressed fleece produces a **much better grinding performance, longer service life, and fine grinding results.**
- For **preparatory grinding and fine grinding of spot welds and deep scratches on stainless steel, steel and non-ferrous metals;** also great for finely deburring perforated sheet metal and reworking **corners.**
- Backing plate of specially developed **flexible, food-grade plastic: easy to trim, damps vibration, and completely free of glass fibre.**

Technical specifications

Dimensions (mm)	Ideal speed (rpm)	Maximum speed (rpm)	Material thickness (mm)	Backing plate	Ideal for	Pkg. unit 	Grit (K)	Article number
Ø 125 x 22.2	2,000 – 5,000	6,000	15	Special flexible plastic	Angle grinders with variable speed	5	80/100	96705



SUITABLE FOR ALL METALS · WOOD

MAGNUM® Top Mix Strong

Combination fleece disc with ceramic grit content – complete 2 operations at once, even greater material removal with fine grinding results



The coordinated combination of ceramic abrasive flaps alternating with foamed fleece produces a much better grinding performance, longer service life, and fine grinding results. For preparatory grinding and fine grinding of spot welds and deep scratches on stainless steel, steel and non-ferrous metals; also great for finely deburring perforated sheet metal and reworking corners.

Benefits at a glance

- With **ceramic grit content** for much **higher material removal** and fine grinding results.
- The highly compressed fleece material has **many times the service life** of conventional combination fleece discs.
- Elastic **natural fibre high-tech compound carrier plate** **protects the environment and users (CO₂-neutral)**, completely **self-trimmable** for complete use of the disc, **noise and vibration dampening**.
- **Integrated M14 thread** ensure simple, fast, convenient disc change.

Technical specifications

Dimensions (mm)	Ideal speed (rpm)	Maximum speed (rpm)	Material thickness (mm)	Backing plate	Ideal for	Pkg. unit	Grit (K)	Article number
Ø 125 x M14	2,000 – 5,000	6,000	15	Natural fibre	Angle grinders with variable speed	5	60/80	96703



CLEANING DISCS

SUITABLE FOR ALL METALS · WOOD · BRICK

MAGNUM® CLEAN-MIX

When things need to move along

Newly designed cleaning wheel with ceramic intermediate abrasive flap layers. For an enhanced cleaning effect and longer disc service life. Open, elastic CLEAN material pores prevent the grinding disc from clogging and achieve a sand-blast-like effect on metal.

The solution for effectively removing mill scale and scale!



Benefits at a glance

- Nylon fibre "Clean" material containing grit, with intermediate ceramic abrasive cloth layers for greater material removal and much longer service life, with consistent grinding results.
- Ideal for cleaning and freshening up wood surfaces, removing shell limestone from ship hulls, etc.
- The disc's external diameter is self-trimmable. No fibre glass components were used.
- The intermediate ceramic abrasive flap layers, tailored to the CLEAN material, ensure uniform wear and therefore consistent grinding results.
- The quickest way to remove scales, rust, burrs, etc. from metals.
- Quick cleaning and renewing of wooden surfaces.
- Elastic, high-tech natural fibre compound backing plate is easy on the environment and the user (CO₂-neutral), fully self-trimmable so that the entire disc can be used, damp noise and vibration, with practical M14 threads, for fixing discs quickly without tools.
- The integrated M14 threads mean that no locking nut is necessary – no risk of contamination from the work piece touching the steel locking nut.

Technical specifications

Dimensions (mm)	Ideal speed (rpm)	Maximum speed (rpm)	Approved for	Material thickness (mm)	Backing plate	Pkg. unit	Ideal for	Grit (K)	Article number
125 mm x M14	2,000-4,500	4,500	30 m/sec	approx. 15	Natural fibre	5	Angle grinders with variable speed	80	96704



SUITABLE FOR ALL METALS · WOOD

MAGNUM® CLEAN-PLUS

Clean more in the same amount of time

The open-pore hard nylon cloth with grinding grit fits well to all work-pieces, does not smear up, and leaves behind a bright surface like that expected from sand-blasting, without changing dimensional tolerance (even thin sheet metal can be easily machined). Also available as HOOK & LOOP version (see page 83).



Benefits at a glance

- Nylon fleece combined with abrasive cloth, **elastic so that it adapts better to the work piece.**
- Large-surface cloth content for **much longer service life.**
- Cleans all materials, such as metals, stone, plastics, and wood (boards and planks), pore-deep.
- **Effect is similar to that of sand-blasting, does not damage the basis.**
- Also removes rust, oxide, paint, Teroson, and much more.
- The sophisticated backing plate allows large-area application of hard fleece components – for less load and thus more than **50% longer service life.**
- **The longest possible service life** for cleaning and removing paint, rust, oxides, etc.
- Elastic, **high-tech natural fibre compound backing plate** is easy on the environment and the user (CO₂-neutral), fully self-trimmable so that the entire disc can be used, damps noise and vibration, with practical M14 threads, for fixing discs quickly without tools.
- The **integrated M14 threads** greatly simplify disc change, and no locking nut is necessary – no risk of contamination from the work piece touching the steel locking nut.

Please note:

Replaces (with great service life and binding technology advantages) **MAGNUM® CLEAN.**

Technical specifications

Dimensions (mm)	Ideal speed (rpm)	Maximum speed (rpm)	Approved for	Material thickness (mm)	Backing plate	Pkg. unit 	Ideal for	Article number
Ø 125 x M14	2,000 – 4,500	4,500	30 m/sec	approx. 15	Natural fibre	5	Angle grinders with variable speed	96706

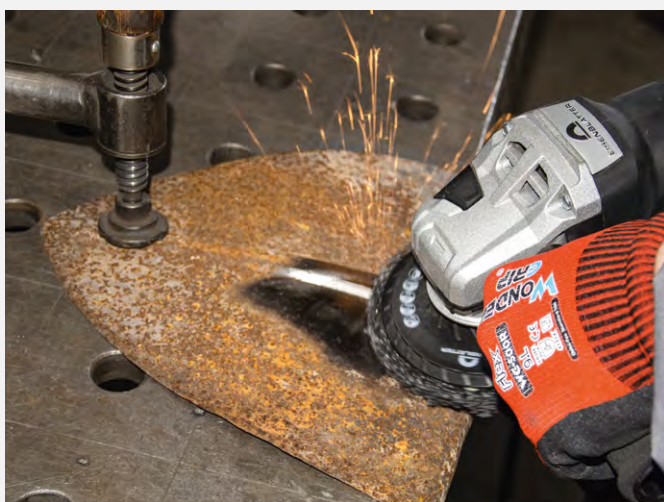

CLEANING DISCS

SUITABLE FOR STAINLESS STEEL

MAGNUM® STAINLESS-CLEAN

Stainless steel cleaning – looking its best

Cleans and smooths stainless steel or steel weld seam surfaces quickly, harmonises and smooths weld seams, and gives them the same perfect, high-level gloss – even in corners.



Benefits at a glance

- **Special fleece fabric** impregnated with **ceramic grit** for **stainless steel machining**.
- Developed for **cleaning** and **smoothing stainless steel weld seams** and surfaces. Removes even **minor spot welds, discolouration, and deep scratches**.
- Full-surface fabric allows **exceptionally long service life**.
- **Extremely long service life guaranteed** due to application on a larger surface (more than 50% larger) than narrow, conventional cleaning rings!
- **Cleans and smooths stainless steel** weld seams and **removes spot welds, discolouration, and scratches**.
- Elastic, **high-tech natural fibre compound backing plate** is easy on the environment and the user (**CO₂-neutral**), fully self-trimmable so that the entire disc can be used, **damps noise and vibration**, with **practical M14 threads**, for fixing discs quickly without tools.
- The **integrated M14 threads** mean that no locking nut is necessary – no risk of contamination from the work piece touching the steel locking nut.

Technical specifications

Dimensions (mm)	Ideal speed (rpm)	Maximum speed (rpm)	Approved for	Material thickness (mm)	Backing plate	Pkg. unit 	Ideal for	Article number
Ø 125 x M14	2,000 – 4,500	4,500	30 m/sec	approx. 15	Natural fibre	5	Angle grinders with variable speed	96708



SUITABLE FOR ALL METALS - WOOD

CLEAN Disc MCD

for drills and polishers

Cleans and removes pore-deep paint, rust, scale, and dirt on all materials – even wood. Effect is similar to that of sand-blasting: cleans without removing material. Ideal for car bodywork, the automotive industry, shipyards, and renovation work by commercial decorators and builders. Also available as a HOOK & LOOP (velcro) version for polishing devices (see page 83).



Suitable clamping shaft

Technical specifications

Dimensions (mm)	Mount	Maximum speed (rpm)	Material thickness (mm)	Pkg. unit 	Article number
Ø 115	for clamping shaft	5.000	13	10	61115
Ø 150	for clamping shaft	4.000	13	10	61150
Clamping shaft	8 mm steel shaft			1	61151



POLISHING DISCS

SUITABLE FOR ALL METALS

BRIGHTEX® FLAP

Berry & Sun

Flexibly fanned polishing disc made of polishing fleece with **pre-impregnated BRIGHTEX® polishing paste**, adapts perfectly to flat and shaped surfaces.

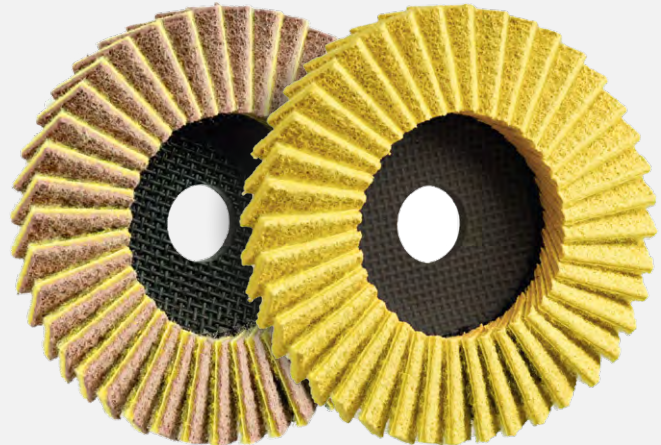

Benefits at a glance

Step 1: BRIGHTEX® FLAP Berry for top high gloss!

- For fast high-gloss polishing of all metals.
- Pre- and main polishing in one, saving additional work steps.
- Polishes lightning fast in one operation, even through existing oxide layers.

Step 2: BRIGHTEX® FLAP Sun for a mirror finish almost like chrome!

- For final high gloss on polished metals.
- Mirror finish almost like chrome – perfect finish.
- For removing the last polishing mist and streaks on all metals.

Please note:

Always remove polishing residue from the work piece after changing the paste! If necessary, the carrier can be re-wetted with BRIGHTEX® pastes (see page 215).

- Can be used immediately without additional pastes and creams!
- For the reconditioning of high-gloss machine-polished surfaces.
- Ideal for use with polishing machines and hand-held polishing devices.
- Completely newly developed high-tech paste recipe.
- Elastic natural fibre high-tech compound carrier plate protects the environment and users (CO₂-neutral), completely self-trimmable for complete use of the disc, noise and vibration dampening.
- Lamellae can be "saturated" several times with BRIGHTEX® solid pastes (note grain size!) (see page 215).
- Polishing residue is best removed with Eisenblätter care and cleaning agents (BRIGHTEX® Softclean Powder page 216, POWER CLEANER page 219).

Technical specifications

Version	Application	Dimensions (mm)	Ideal speed (rpm)	Maximum speed (rpm)	Backing plate	Pkg. unit 	Article number
Berry (pink)	High-gloss polishing	Ø 115 x 22	600 – 3,000	5,850	Natural fibre	5	96746
		Ø 125 x 22		5,350			96748
Sun (yellow)	Mirror-finish polishing	Ø 115 x 22	600 – 3,000	5,850	Natural fibre	5	96747
		Ø 125 x 22		5,350			96749





POLISHING DISCS

Test sets

SUITABLE FOR ALL METALS

BRIGHTEX® FLAP Test Set

Pre- and main polishing up to the perfect mirror finish

Test the flexibly fanned BRIGHTEX® FLAP polishing discs now! Made of polishing fleece with already pre-impregnated BRIGHTEX® polishing paste, they adapt perfectly to flat and shaped surfaces and remove even the finest streaks and any polishing mist in a flash. **BRIGHTEX® FLAP Berry** for preliminary and main polishing and **BRIGHTEX® FLAP Sun** for a perfect mirror finish.

Can be used immediately on all metals without additional polishing pastes or creams.

There is also the **POWER CLEANER** (see page 219) and the **BRIGHTEX® microfibre cloth** (see page 216) to remove polishing residue from the work piece.



Technical specifications

Application	Set content	Packaging	Pkg. unit	Article number
Pre- and main polishing up to perfect mirror finish	1 BRIGHTEX® FLAP Berry polishing disc 125 x 22.2 mm 1 BRIGHTEX® FLAP Sun polishing disc 125 x 22.2 mm 1 POWER CLEANER 50 ml spray bottle 1 BRIGHTEX® microfibre cloth 400 x 400 mm	Resealable bag	1	99327

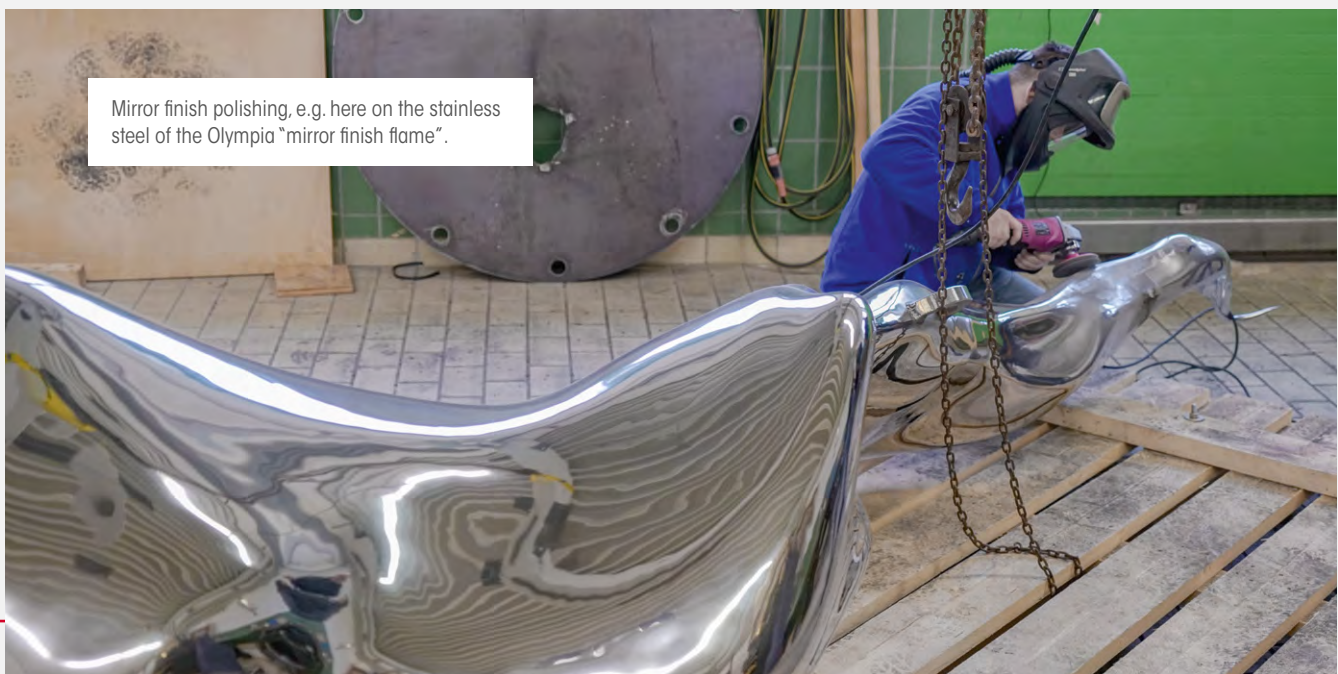

Mirror finish polishing, e.g. here on the stainless steel of the Olympia "mirror finish flame".

SUITABLE FOR HOOK & LOOP TOOLS

FIX HOOK & LOOP Special Backing Pad

Specially designed pad of flexible polyurethane with a click system, stabilising fins, and 10-mm centring pin to ensure that the disc runs perfectly. Other thread mounts (M10, 5/8") are available upon request.

Optional: A flexible, 6-mm-thick damping adapter with harpoon HOOK & LOOP and a special damping layer.

The centring pin is visible for exact grinding disc centring.

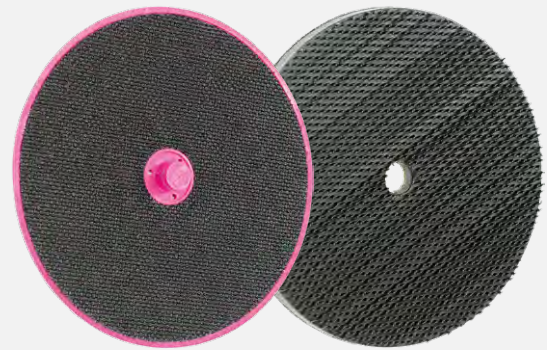

Technical specifications

Item	Dimensions (mm)	Maximum speed (rpm)	Mount	Material	HOOK & LOOP material	Pkg. unit 	Article number
Special backing pad	Ø 96	11,000	M14 thread	Polyurethane plastic	Mushroom HOOK & LOOP	1	80100p
	Ø 110	10,500	M14 thread	Polyurethane plastic	Mushroom HOOK & LOOP	1	80115p
	Ø 119	10,100	M14 thread	Polyurethane plastic	Mushroom HOOK & LOOP	1	80123p
	Ø 143	8,500	M14 thread	Polyurethane plastic	Mushroom HOOK & LOOP	1	80150p
	Ø 168	7,200	M14 thread	Polyurethane plastic	Mushroom HOOK & LOOP	1	80160p
Soft damping adapter	Ø 110	10,500	HOOK & LOOP	Foam	Harpoon HOOK & LOOP	5	80120
	Ø 143	8,500	HOOK & LOOP	Foam	Harpoon HOOK & LOOP	5	80155

Which FIX HOOK & LOOP disc can you use with or without a soft damping adapter? Here are our recommendations:

With these FIX HOOK & LOOP discs, use either the backing pad only or the backing pad with soft damping adapter:



Only use the backing pad with these FIX HOOK & LOOP discs:



With these FIX HOOK & LOOP discs, use the support pad in conjunction with the soft damping adapter:

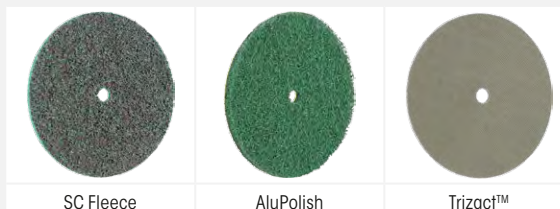

FIX HOOK & LOOP SYSTEM

Quick change system Ø 100 – 178 mm

SUITABLE FOR STEEL · STAINLESS STEEL · NON-FERROUS METALS

FIX HOOK & LOOP Cool Top® Flap Disc

With Cool Top® pure zirconium abrasive. **Superb material removal, extremely long service life**, uniformly clean results and **no material discolouration** or smearing. Highly flexible flap disc – adjusts to work-pieces of any shape to produce **unbeatable finish in plane cut optics**.



Technical specifications

Dimensions (mm)	Ideal speed (rpm)	Maximum speed (rpm)	Approved for (DIN EN 13743)	Backing	Pkg. unit	Grit (K)	Article number
Ø 115	7,000 – 9,000	10,500	63 m/sec	HOOK & LOOP	25	40	80340
						60	80360
						80	80380
						120	80390
Ø 125	6,000 – 8,000	9,600	63 m/sec	HOOK & LOOP	25	40	80440
						60	80460
						80	80480
						120	80490
Ø 150	6,000 – 7,000	8,000	63 m/sec	HOOK & LOOP	25	40	80540
						60	80560
						80	80580
						120	80590



Change discs in seconds with the Eisenblätter FIX HOOK & LOOP and MINI FIX HOOK & LOOP systems. Centring pin ensures that the disc runs perfectly.

SUITABLE FOR STEEL · STAINLESS STEEL

FIX HOOK & LOOP Zircon Disc Elastic



Zirconium fibre disc with outstanding results for coarse grinding and pre-polishing. Levels weld seams and removes scratches. Ideal for work on car bodies and in motor vehicle workshops.

Technical specifications

Dimensions (mm)	Ideal speed (rpm)	Maximum speed (rpm)	Approved for (DIN EN 13743)	Backing	Pkg. unit	Grit (K)	Article number
Ø 115	5,000 – 10,000	10,500	63 m/sec	HOOK & LOOP	50	40	80904
						60	80906
						80	80908
						120	80909
Ø 150	4,000 – 8,000	8,000	63 m/sec	HOOK & LOOP	50	40	80914
						60	80916
						80	80918
						120	80919



SUITABLE FOR ALL METALS · WOOD · BRICK

FIX HOOK & LOOP CLEAN Disc

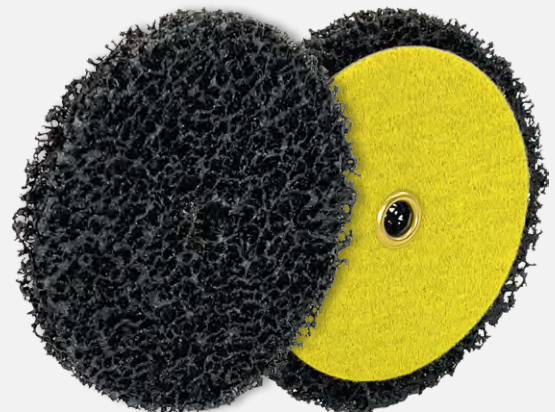

Cleans and removes pore-deep paint, rust, scale, and dirt on all materials. Effect is similar to that of sand-blasting: cleans without removing material. Ideal for car bodywork, the automotive industry, shipyards, and renovation work by commercial decorators and builders.

Technical specifications

Dimensions (mm)	Ideal speed (rpm)	Maximum speed (rpm)	Material thickness (mm)	Backing	Pkg. unit	Article number
Ø 115	2,000 – 4,500	5,000	13	HOOK & LOOP	5	80901
Ø 150	2,000 – 4,000	5,000	13	HOOK & LOOP	5	80900



FIX HOOK & LOOP SYSTEM

Quick change system Ø 100 – 178 mm

SUITABLE FOR ALUMINUM - NON-FERROUS METALS

FIX HOOK & LOOP AluPolish Disc

Soft special fleece material for the fine grinding (pre-polishing) of aluminum and "soft" metals for a later, perfect mirror finish. Used without pastes or creams. Removes fine scratches and leaves no smears on aluminium. When grinding with this disc, we recommend using the FIX HOOK & LOOP backing pad in combination with the soft damping adapter, see page 81.

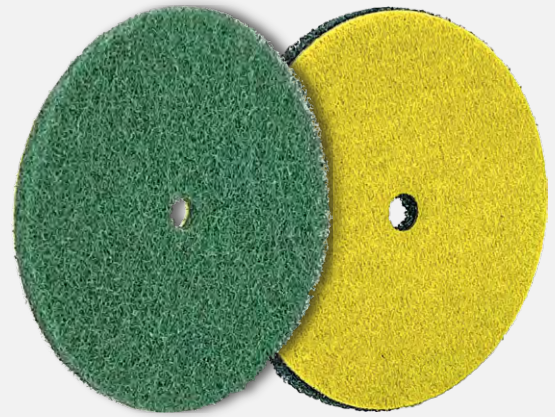

Technical specifications

Dimensions (mm)	Ideal speed (rpm)	Maximum speed (rpm)	Backing	Pkg. unit 	Grit (fleece)	Article number
Ø 115	2,000 – 3,000	4,000	HOOK & LOOP	10	very fine	80680
Ø 150	2,000 – 3,000	3,000	HOOK & LOOP	10	very fine	80690



SUITABLE FOR STEEL · STAINLESS STEEL · NON-FERROUS METALS · WOOD · HARD PLASTICS

FIX HOOK & LOOP SC Fleece Discs

Technical surface conditioning fleece ideally suited to **deburring, fine grinding, and removing oxide layers.**

The newly developed **1FOR2 SC fleece fabric** (green) includes **ceramic grit** that allows **weld seams and spot welds to be removed** with a fine finish and clean, soft grinding transitions.

When grinding with this disc, we recommend using the **FIX HOOK & LOOP** backing pad in combination with the soft damping adapter, see page 81.



Technical specifications

Dimensions (mm)	Ideal speed (rpm)	Maximum speed (rpm)	Approved for (DIN EN 13743)	Material	Backing	Pkg. unit 	Grit (K)	Colour (fleece)	Grit (fleece)	Article number
Ø 100	5,000 – 8,000	12,000	63 m/sec	SC nylon fleece with reinforcing fabric	HOOK & LOOP	10	80	brown	coarse	80605
							180	red	medium	80606
							280	blue	fine	80607
Ø 115	4,000 – 7,000	10,500	63 m/sec	SC nylon fleece with reinforcing fabric	HOOK & LOOP	10	40	green	1FOR2 extra-coarse	80613
							80	brown	coarse	80615
							180	red	medium	80616
							280	blue	fine	80617
							400	grey	very fine	80618
Ø 125	4,000 – 6,000	9,600	63 m/sec	SC nylon fleece with reinforcing fabric	HOOK & LOOP	10	40	green	1FOR2 extra-coarse	80624
							80	brown	coarse	80625
							180	red	medium	80626
							280	blue	fine	80627
Ø 150	3,000 – 5,000	8,000	63 m/sec	SC nylon fleece with reinforcing fabric	HOOK & LOOP	10	40	green	1FOR2 extra-coarse	80649
							80	brown	coarse	80650
							180	red	medium	80651
							280	blue	fine	80652
							400	grey	very fine	80653
Ø 178	2,000 – 4,000	6,700	63 m/sec	SC nylon fleece with reinforcing fabric	HOOK & LOOP	10	80	brown	coarse	80670
							180	red	medium	80671
							280	blue	fine	80672



FIX HOOK & LOOP SYSTEM

Quick change system Ø 100 – 178 mm

SUITABLE FOR STEEL - STAINLESS STEEL

FIX HOOK & LOOP Trizact™ Disc

New type of **abrasive cloth with pyramid-shaped grit structure and additional heat-insulating layer. Saves on several operating steps** and has high material removal with **very fine results while removing scratches and spot welds.** Ideal pre-polishing for subsequent mirror-finish polishing. Leaves very **minor surface roughness.** When grinding with this disc, we recommend using the FIX HOOK & LOOP backing pad in combination with the soft damping adapter, see page 81.

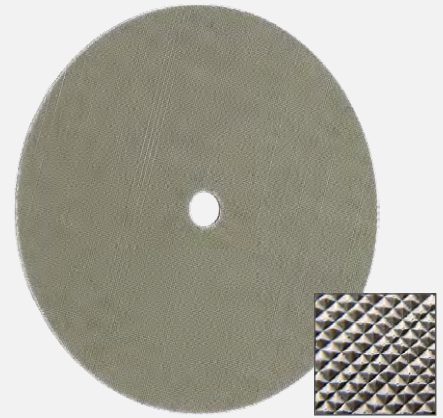

Technical specifications

Dimensions (mm)	Ideal speed (rpm)	Maximum speed (rpm)	Approved for (DIN EN 13743)	Backing	Pkg. unit	Grit (Trizact™)	Grit (K)	Material removal (like approx. K)	Article number
Ø 115	4,000 – 6,000	10,500	63 m/sec	HOOK & LOOP	10	A160	120	24	80930
						A100	220	36	80931
						A65	280	40	80932
						A45	400	50	80940
						A30	600	60	80960
						A16	1200	80	80970
						A06	2000	120	80980
Ø 150	3,000 – 5,000	8,000	63 m/sec	HOOK & LOOP	10	A160	120	24	80983
						A100	220	36	80984
						A65	280	40	80985
						A45	400	50	80986
						A30	600	60	80987
						A16	1200	80	80988
						A06	2000	120	80989



SUITABLE FOR ALL METALS

FIX HOOK & LOOP BRIGHTEX® Discs

Berry & Sun

Polishing material that is already impregnated with **BRIGHTEX® polishing paste** removes the time-consuming hassle of applying pastes and creams to give untreated metal a **shadow-free mirror finish**.



Benefits at a glance

Step 1: BRIGHTEX® Berry (pre-polishing):

- For applying a rapid high-gloss polish to all metals.
- Pre-polish and main polish in one – save on additional operations.

Step 2: BRIGHTEX® Sun (main polish):

- A mirror finish that's almost like chrome plating – perfect finish.
- For a final high-gloss shine on polished metals.
- For removing any residual clouding and smears from all metals.

Please note:

After changing pastes, always remove the polish residue from the work piece! As necessary, the backing can be re-wetted with BRIGHTEX® pastes (see page 215).

- For reconditioning high-gloss surfaces which have been polished mechanically.
- Ideal for use with polishing machines and hand-held polishing tools.
- For the best results, use **Eisenblätter care and cleaning products** for removing polish residues (see BRIGHTEX® Softclean Powder page 216, POWER CLEANER page 219).
- With centring hole for backing pads with centring pins.
- Completely new **high-tech paste formulation** for metals.
- For immediate use without additional pastes and creams!

Technical specifications

Version	Application	Dimensions (mm)	Material thickness (mm)	Ideal speed (rpm)	Maximum speed (rpm)	Backing	Pkg. unit 	Article number
Berry (pink)	High-gloss polishing	Ø 115	5	2,500 – 3,500	10,500	HOOK & LOOP	10	80718
		Ø 125	5	2,000 – 3,000	9,600	HOOK & LOOP	10	80728
		Ø 150	5	2,000 – 2,500	8,000	HOOK & LOOP	10	80753
		Ø 178	5	2,000	6,700	HOOK & LOOP	10	80773
Sun (yellow)	Mirror-finish polishing	Ø 115	5	2,500 – 3,500	10,500	HOOK & LOOP	10	80719
		Ø 125	5	2,000 – 3,000	9,600	HOOK & LOOP	10	80729
		Ø 150	5	2,000 – 2,500	8,000	HOOK & LOOP	10	80754
		Ø 178	5	2,000	6,700	HOOK & LOOP	10	80774



FIX HOOK & LOOP SYSTEM

Quick change system Ø 100 – 178 mm

SUITABLE FOR ALL METALS

FIX HOOK & LOOP SuperPolish Disc

Revolutionary special fleece. Used with polishing pastes and creams for a shiny mirror finish on stainless steel and non-ferrous metals which leaves no smears or shadows. Polishing pastes and cream see pages 215 and 218.

Please note: Always use an extra SuperPolish disc for each paste and cream to avoid mixing different grits.



Technical specifications

Dimensions (mm)	Ideal speed (rpm)	Maximum speed (rpm)	Material thickness (mm)	Backing	Pkg. unit 	Article number
Ø 115	3,000 – 6,000	10,500	5	HOOK & LOOP	10	80715n
Ø 125	3,000 – 6,000	9,600	5	HOOK & LOOP	10	80725n
Ø 150	2,000 – 5,000	8,000	5	HOOK & LOOP	10	80750n
Ø 178	2,000 – 5,000	6,700	5	HOOK & LOOP	10	80770n



SUITABLE FOR ALUMINUM · NON-FERROUS METALS · HARD PLASTICS

FIX HOOK & LOOP Felt Disc

First-class Merino felt for rapid mirror finish using polishing pastes and creams that leave no scratches or smears.

Polishing pastes and cream see pages 215 and 218.

Please note: Always use an extra SuperPolish disc for each paste and cream to avoid mixing different grits.



Technical specifications

Dimensions (mm)	Ideal speed (rpm)	Maximum speed (rpm)	Material thickness (mm)	Material	Backing	Pkg. unit 	Article number
Ø 100	3,000 – 6,000	12,000	5	Merino felt	HOOK & LOOP	10	80705
Ø 115	3,000 – 6,000	10,500	5	Merino felt	HOOK & LOOP	10	80715
Ø 125	3,000 – 6,000	9,600	5	Merino felt	HOOK & LOOP	10	80725
Ø 150	2,000 – 5,000	8,000	5	Merino felt	HOOK & LOOP	10	80750
Ø 178	2,000 – 5,000	6,700	5	Merino felt	HOOK & LOOP	10	80770



MULTIFUNCTIONAL GRINDING

MINI MAX® MULTIFUNCTIONAL GRINDERS90

NEW MINI MAX® 1100	90
MINI MAX® AKKU	92
Flexible shaft	94
Accessory sets	96

MINI MAX® GRINDING SLEEVES97

MINI MAX® expansion roller	97
MINI MAX® zircon sleeve	97

MINI MAX® GRINDING WHEELS98

MINI MAX® flap wheel	98
MINI MAX® Mix wheel	99
MINI MAX® fleece wheel	99

MINI MAX® POLISHING TIPS AND CLAMPING SHAFT100

MINI MAX® felt polishing tips	100
MINI MAX® clamping shaft	100

MINI MAX® TECHNICAL BRUSHES101

MINI MAX® stainless steel wire wheel	101
MINI MAX® stainless steel wire brush	101

MINI FIX HOOK & LOOP SYSTEM102

MINI FIX HOOK & LOOP special backing pad	102
MINI FIX HOOK & LOOP Cool Top® flap disc	103
MINI FIX HOOK & LOOP SC fleece discs	104
MINI FIX HOOK & LOOP Trizact™ disc	104
MINI FIX HOOK & LOOP BRIGHTEX® Berry & Sun polishing discs	105
MINI FIX HOOK & LOOP SuperPolish disc	106
MINI FIX HOOK & LOOP felt disc	106

PINLOC SYSTEM107

PINLOC starter set	107
PINLOC backing pad	108
PINLOC HellFire® disc	108
PINLOC COLDSTEEL® disc	109
PINLOC zircon disc	109
PINLOC Cool Top® flap disc	110
PINLOC Trizact™ disc	110
PINLOC DecoFinish disc	111
PINLOC SC fleece discs	111
PINLOC BRIGHTEX® Berry & Sun polishing discs	112
PINLOC SuperPolish disc	113
PINLOC CLEAN disc	113



MINI MAX® MULTIFUNCTIONAL GRINDERS

Mains powered machines

SUITABLE FOR GRINDING TASKS IN DIFFICULT PLACES

MINI MAX® 1100 Multifunctional Grinder

Two functions in a single device:
Angle grinder and linear grinder!

The mini workshop for every craftsman: The new, revised MINI MAX® 1100 once again promises significantly **more power reserves for continuous professional use**. In addition to the new, powerful and speed-controlled drive motor, the new universal sander shines **with significantly improved dust protection and mechanics**.

The **speed ranges have been expanded** and offer the ideal drive unit with **perfect longitudinal guidance** for clean, shadow-free surfaces for a variety of **mini shaft tools (fleece, mop, polisher and much more)**. Thanks to the balanced weight distribution, you can work **completely fatigue-free** even for many hours.



Also available as a CAS cordless machine:
MINI MAX® AKKU (page 92)



Benefits at a glance

- **Particularly versatile** and indispensable for **service, repair, assembly, motor vehicles, painting workshops** and much more.
- **For grinding tasks in difficult places** (corners, edges, inner containers, etc.), **coarse grinding, fine grinding, satin finishing, matting, polishing to a mirror finish, mini angle grinding and cut-off grinding**.
- **Ideal drive motor for flexible shafts** with a 6 mm mount.
- The working temperature of the grinding arm and the gear head is massively reduced by a new type of air duct system, making the **MINI MAX® 1100 ideal for continuous use**.
- **Made in Germany**.
- **Ideal for the Eisenblätter MINI FIX HOOK & LOOP and the Eisenblätter PINLOC system**. Also suitable for other systems available on the market such as **ROLOC™, FASTLOCK** or similar.
- **Extensive range of grinding tools for every grinding task on stainless steel, steel, non-ferrous metals, aluminum, wood and plastics**.
- Can be used with a **ball joint holder** to securely fix the drive motor when working with the **flexible shaft** or as a **stationary grinder**.
- **Switch-off carbon brushes** to protect the motor.
- **Foam rubber handle** for "soft", vibration-neutral grinding.

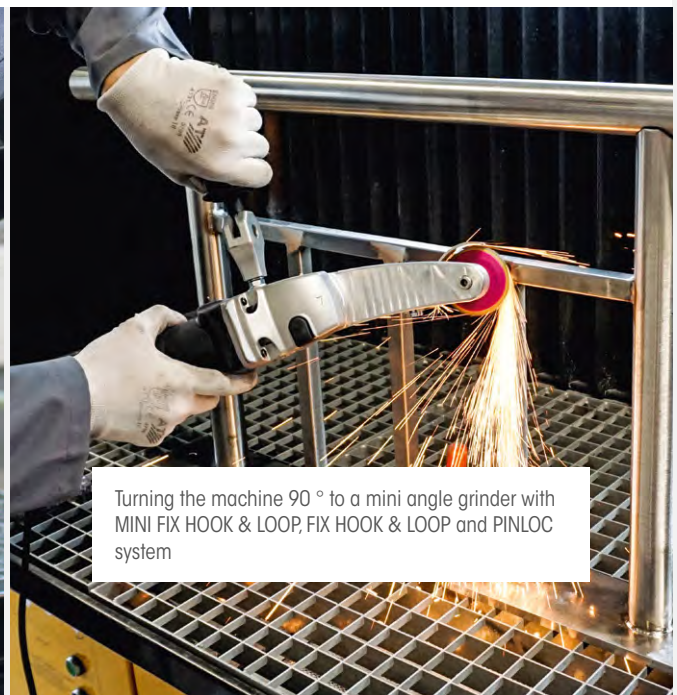

MINI MAX® MULTIFUNCTIONAL GRINDERS

Mains powered machines

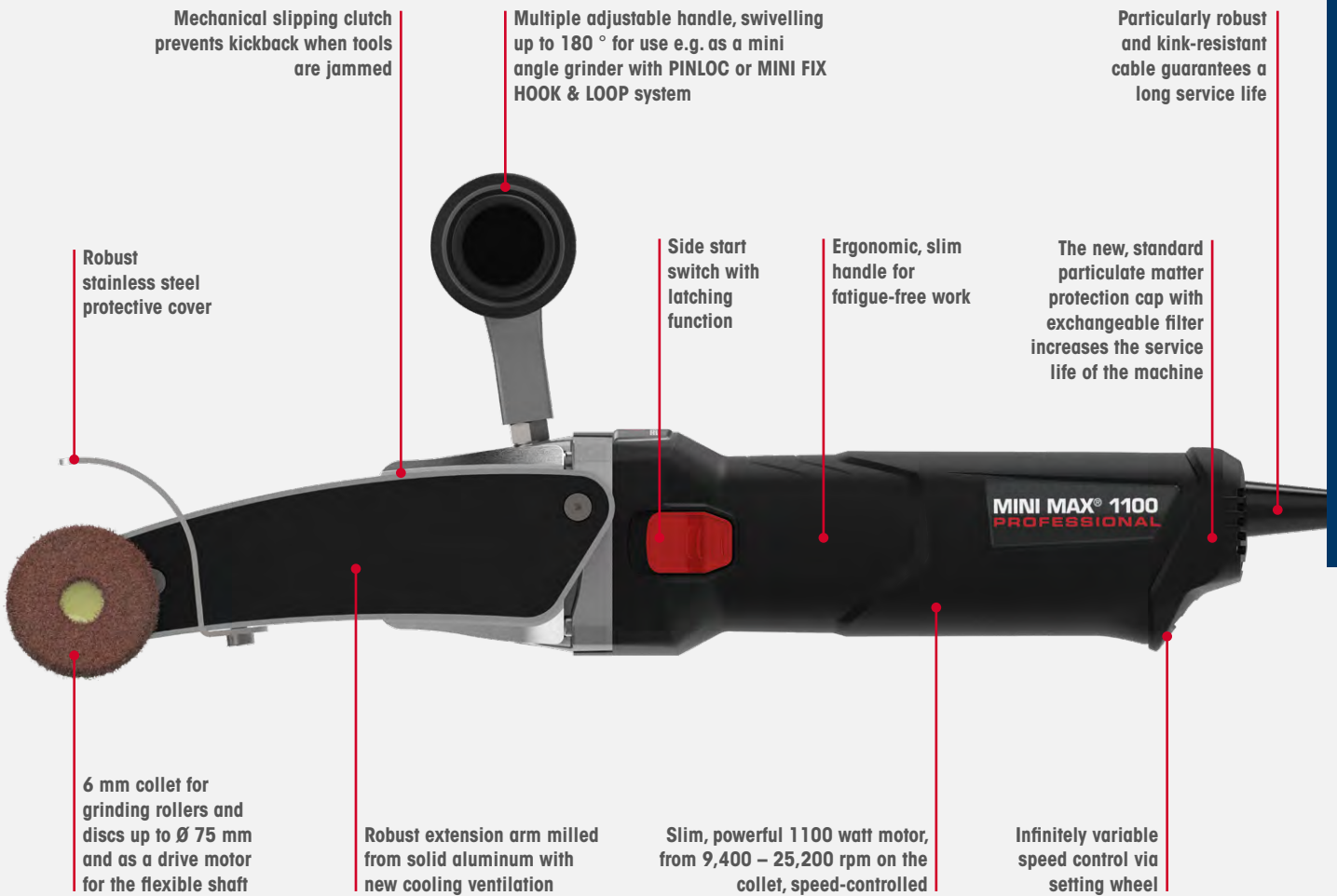

MULTIFUNCTIONAL GRINDING

Technical specifications MINI MAX® 1100 multifunctional grinder

Plug type	Cable type	Mains connection (V ~ Hz)	Power (W)	Mount (mm)	Speed (rpm)	Weight (kg)	Pkg. unit 	Article number
EU (C+F)	Permanent connection	220 – 240 ~ 50 – 60	1,100	Collet for Ø 6	9,400 – 25,200	2.8	1	10051

- Contents:**
- 1 MINI MAX® 1100 basic device
 - 1 Robust, impact-resistant plastic case
 - 1 Particulate matter protection cap
 - 1 MINI FIX HOOK & LOOP backing pad
 - 1 MINI FIX HOOK & LOOP Cool Top® flap disc
 - 1 Fleece wheel, 6 mm shaft

Please note: Practical accessory set see page 96.

The new, standard particulate matter protection cap with exchangeable filter increases the service life of the machine!



Extensive range of tools available (from page 97):

Sleeves, wheels, MINI FIX HOOK & LOOP system, PINLOC system and much more!



The ideal addition to your machine: MINI MAX® PRO accessory set (page 96)



MINI MAX® MULTIFUNCTIONAL GRINDERS

CAS cordless machines

SUITABLE FOR GRINDING TASKS IN DIFFICULT PLACES

MINI MAX® AKKU

The mini workshop for on the go

Mini longitudinal and angle grinder and cutter in a single device! Ideal for all 6-mm shaft tools, the MINI-FIX HOOK & LOOP system, and the ROLOC™/PINLOC systems. Especially sturdy extension arm for versatile work at any point.



Benefits at a glance

- Indispensable for maintenance, repair, fitting work, motor vehicles, paint workshops, and much more.
- **Can also be used as a drive motor for flexible shafts** with a 6 mm shaft.
- **Also ideal for all ROLOC™ and PINLOC systems.**
- **Extensive range of grinding tools for any grinding task** on stainless steel, steel, non-ferrous metals, aluminium, wood, and plastics.
- **For grinding jobs in hard-to-reach places** (corners, edges, internal tanks, etc.), coarse grinding, fine grinding, satin finish, matt finish, polishing to a mirror finish, mini-cutting and cut-off grinding.
- Can be used with the **ball joint mount** for secure fixing of the drive motor, including for work with the **flexible shaft** or as a **stationary grinder**.
- **Powerful 18-volt special motor**, made in Germany.



One battery, many solutions. Cross-brand. 100% Compatibility.



MINI MAX® MULTIFUNCTIONAL GRINDERS

CAS cordless machines

MULTIFUNCTIONAL GRINDING

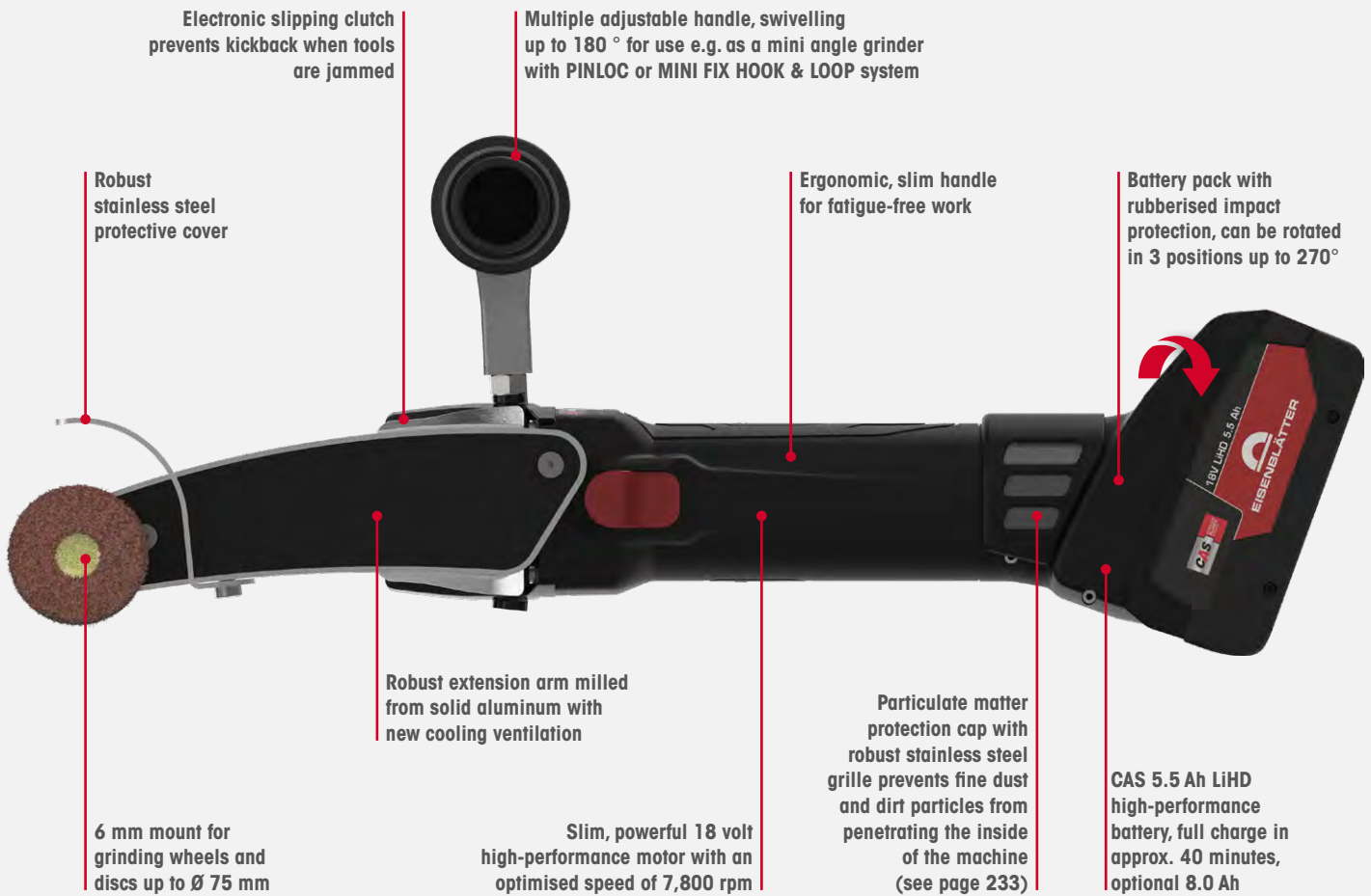

Technical specifications MINI MAX® AKKU basic set / basic device (without CAS batteries, charger and accessories)

Item	Plug type	Cable type	Mains connection (V ~ Hz)	Power (V)	Mount (mm)	Speed (rpm)	Weight (kg)	Pkg. unit	Article number
Basic set	EU (C+F)	Permanent connection	220 – 240 ~ 50 – 60	18	Collet for Ø 6	7,800	2.0	1	10041
Basic device	EU (C+F)	Permanent connection	220 – 240 ~ 50 – 60	18	Collet for Ø 6	7,800	2.0	1	10042

Scope of delivery MINI MAX® AKKU basic set:

- 1 MINI MAX® AKKU basic device
- 1 Robust, impact-resistant plastic case
- 1 Particulate matter protection cap
- 2 LiHD batteries 18 volts with 5.5 Ah capacity (CAS)
- 1 Fast charger incl. cable (CAS)
- 1 MINI FIX HOOK & LOOP backing pad
- 1 MINI FIX HOOK & LOOP Cool Top® flap disc
- 1 Fleece wheel, 6 mm shaft



Please note: Practical accessory set see page 96, batteries and chargers see page 229.

Scope of delivery MINI MAX® AKKU basic device:

- 1 MINI MAX® AKKU basic device
- 1 Robust, impact-resistant plastic case



Attention: No battery and no charger included!



The complete PINLOC quick change system can be found on page 107.



With adapter also suitable for the MINI FIX HOOK & LOOP system (see page 102).

The ideal addition to your machine: MINI MAX® PRO accessory set (see page 96)



MINI MAX® MULTIFUNCTIONAL GRINDERS

Flexible shafts

SUITABLE FOR MINI MAX®

Flexible Shaft

Flexible shaft with steel core for working in narrow and particularly hard-to-reach places. All MINI MAX® grinding tools can also be used with the flexible shaft.



Technical specifications

Length (mm)	Collet (mm)	Mount	Maximum speed (rpm)	Can be used with (Ø mm)	Pkg. unit 	Article number
1,400	Ø 6	6 mm steel shaft	25,000	up to 75	1	10010



Eisenblätter quick change systems – easy and quick disc change

MINI FIX HOOK & LOOP p.102 Discs Ø 60 mm

Discs are attached to the MINI FIX HOOK & LOOP special adhesive backing plate by placing it in the middle using a centring pin and then pressing it down (click).

MINI FIX HOOK & LOOP products at a glance:

MINI FIX HOOK & LOOP special backing pad	102
MINI FIX HOOK & LOOP Cool Top® flap disc	103
MINI FIX HOOK & LOOP SC fleece discs	104
MINI FIX HOOK & LOOP Trizact™ disc	104
MINI FIX HOOK & LOOP BRIGHTEX® Berry & Sun discs .	105
MINI FIX HOOK & LOOP SuperPolish disc	106
MINI FIX HOOK & LOOP felt disc	106



FIX HOOK & LOOP p.81 Discs Ø 100 – 178 mm

Discs are attached to the FIX HOOK & LOOP special adhesive backing plate by placing it in the middle using a centring pin and then pressing it down (click).

FIX HOOK & LOOP products at a glance:

FIX HOOK & LOOP special backing pad	81
FIX HOOK & LOOP Cool Top® flap disc	82
FIX HOOK & LOOP zircon disc	83
FIX HOOK & LOOP CLEAN disc	83
FIX HOOK & LOOP AluPolish disc	84
FIX HOOK & LOOP SC fleece discs	85
FIX HOOK & LOOP Trizact™ disc	86
FIX HOOK & LOOP BRIGHTEX® Berry & Sun discs	87
FIX HOOK & LOOP SuperPolish disc	88
FIX HOOK & LOOP felt disc	88



PINLOC p.107 Discs Ø 50 – 75 mm

The discs are attached to the PINLOC backing pad by simply twisting them.

All Eisenblätter PINLOC products are compatible with comparable quick-change systems with a 1/4" thread that are available on the market! The PINLOC backing pad is also available with an M14 thread for use with angle grinders.

PINLOC products at a glance:

PINLOC backing pad	108
PINLOC HellFire® disc	108
PINLOC COLDSTEEL® disc	109
PINLOC zircon disc	109
PINLOC Cool Top® flap disc	110
PINLOC Trizact™ disc	110
PINLOC DecoFinish disc	111
PINLOC SC fleece discs	111
PINLOC BRIGHTEX® Berry & Sun discs	112
PINLOC SuperPolish disc	113
PINLOC CLEAN disc	113



We recommend the PINLOC starter set to get to know each other, see page 107.

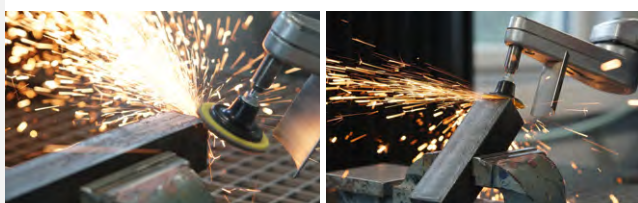

MINI MAX® MULTIFUNCTIONAL GRINDERS

Accessory sets

SUITABLE FOR MINI MAX® 1100 - MINI MAX® AKKU

MINI MAX® PRO Accessory Set

43
TEILE
PARTS

The practical accessory set consists of a wide selection of tools for work ranging from coarse grinding to perfect mirror finish. Everything is ready to go in a practical, sturdy carrying case.

Technical specifications

Application	Can be used with	Mount	Pkg. unit 	Article number
From coarse grinding to perfect mirror finish	MINI MAX® 1100, MINI MAX® AKKU	6 mm	1	10032

Contents:

- | | |
|--|---|
| 1 Mobile tool case | 2 MINI FIX HOOK & LOOP Cool Top® flap discs |
| 2 Flap wheels | 10 MINI FIX HOOK & LOOP BRIGHTEX® polishing discs |
| 2 Mix wheels | 2 BRIGHTEX® mini polishing pastes |
| 2 Fleece wheels | 1 BRILLIANCE CLEAN 50 ml |
| 2 Mini expansion rollers | 1 POWER CLEANER 50 ml |
| 8 Zircon sleeves | 1 INOX PROTECT 50 ml |
| 3 Felt polishing tips | 1 BRIGHTEX® Soficlean Powder |
| 1 MINI FIX HOOK & LOOP backing pad | 2 BRIGHTEX® microfibre cloths |
| 2 MINI FIX HOOK & LOOP SC fleece discs | |



The ideal supplement for these MINI MAX® multifunctional grinders:

NEW



MINI MAX® 1100

p. 90



MINI MAX® AKKU

p. 92

SUITABLE FOR MINI MAX® ZIRCON SLEEVE

MINI MAX® Expansion Roller

Expanding rubber roller for safely mounting MINI MAX® zirconium sleeves.

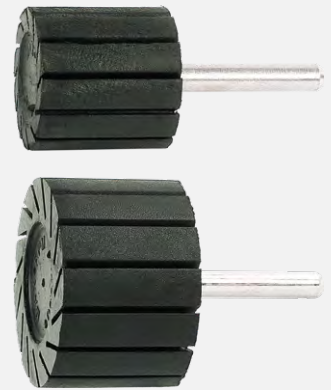

Technical specifications

Dimensions (mm)	Mount	Maximum speed (rpm)	Pkg. unit 	Article number
Ø 30 x 30	6 mm steel shaft	12,000	1	10201
Ø 45 x 30		12,000	1	10202



SUITABLE FOR STEEL · STAINLESS STEEL · NON-FERROUS METALS

MINI MAX® Zircon Sleeve

Significantly longer service life compared to conventional A/O sleeves thanks to zirconium fabric. Zirconium sleeves are simply attached to the expansion roller. For general material removal and elimination of weld seams, heavy burring, deep scratches, etc. Suitable expansion roller see page 97.



Technical specifications

Dimensions (mm)	Maximum speed (rpm)	Pkg. unit 	Grit (K)	Article number
Ø 30 x 30	12,000	50	40	10214
			60	10216
			80	10218
Ø 45 x 30	12,000	50	40	10224
			60	10226
			80	10228



MINI MAX® GRINDING WHEELS

Grinding and blending

SUITABLE FOR ALL METALS · WOOD · HARD PLASTICS

MINI MAX® Flap Wheel

Highly elastic flap wheel adapts to the workpiece. For cleaning, de-rusting, removing scratches, longitudinal grinding. With 6 mm steel shaft for quick tool changes.

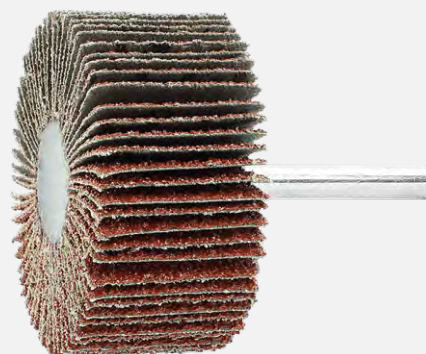

Technical specifications

Dimensions (mm)	Mount	Maximum speed (rpm)	Material	Pkg. unit 	Grit (K)	Article number
Ø 40 x 10	6 mm steel shaft	12,000	High-quality corundum	10	40	11040
					60	11060
					80	11080
					100	11100
Ø 60 x 30	6 mm steel shaft	12,000	High-quality corundum	10	40	11041
					60	11061
					80	11081
					100	11101



SUITABLE FOR STEEL · STAINLESS STEEL · NON-FERROUS METALS · WOOD · HARD PLASTICS

MINI MAX® Mix Wheel

For removing minor scratches, oxide, and paint.
Applying linear structures. With 6 mm steel shaft for quick tool changes.

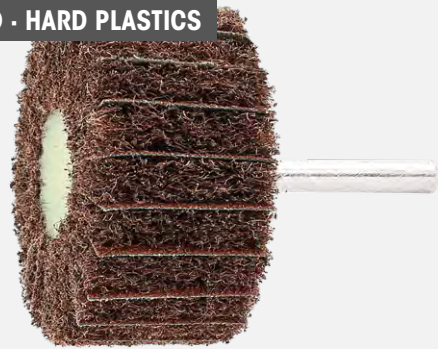

Technical specifications

Dimensions (mm)	Mount	Maximum speed (rpm)	Material	Pkg. unit 	Grit (K)	Article number
Ø 40 x 20	6 mm steel shaft	17,100	Nylon fleece in combination with abrasive cloth	10	80	14080
					150	14150
					240	14240
Ø 60 x 30	6 mm steel shaft	11,500	Nylon fleece in combination with abrasive cloth	10	80	14081
					150	14151
					240	14241



SUITABLE FOR ALL METALS · WOOD · HARD PLASTICS

MINI MAX® Fleece Wheel

For matt finishing, fine grinding, and removing oxide. For smoothing wood fibre and hard plastic. Application of fine linear structures (finish).
With 6 mm steel shaft for quick tool changes.

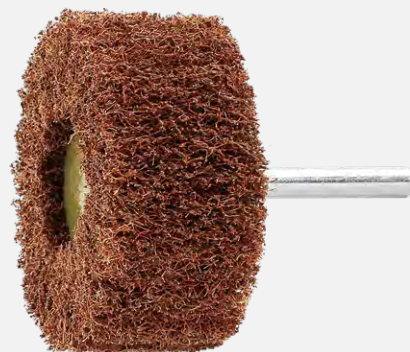

Technical specifications

Dimensions (mm)	Mount	Maximum speed (rpm)	Material	Pkg. unit 	Grit (fleece)	Grit (fleece)	Grit (approx. K)	Article number
Ø 40 x 20	6 mm steel shaft	17,100	Flexible nylon fleece impregnated with grit	10	coarse	M	80	13001
					medium	F	180	13002
					fine	VF	280	13003
					very fine	UF	400	13004
Ø 60 x 30	6 mm steel shaft	11,500	Flexible nylon fleece impregnated with grit	10	extra-coarse	C	60	13010
					coarse	M	80	13011
					medium	F	180	13012
					fine	VF	280	13013
					very fine	UF	400	13014

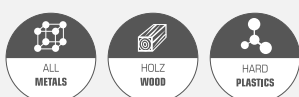

SUITABLE FOR STAINLESS STEEL · NON-FERROUS METALS · HARD PLASTICS

MINI MAX® Felt Polishing Tips

First-class Merino felt tips for polishing in corners, cavities, and recesses. Ideal for use with the flexible shaft (see page 94). Polishing pastes and cream see pages 215 and 218.



Technical specifications

Dimensions (mm)	Mount	Shape	Material	Pkg. unit 	Article number
Ø 20 x 25	6 mm steel shaft	round	Merino felt	10	10020
Ø 30 x 35	6 mm steel shaft	cylindrical	Merino felt	10	10021
Ø 15 x 30	6 mm steel shaft	conical	Merino felt	10	10022



SUITABLE FOR POLISHING RINGS · WIRE WHEELS

MINI MAX® Clamping Shaft

With support discs and locking nut

Clamping shaft for polishing rings and 12-mm-wide wire wheels used with the MINI MAX®, flexible shaft, drills, or straight grinders. Matching polishing rings from page 149 and wire wheels from page 151.



Technical specifications

Mount (mm)	Material	Maximum speed (rpm)	Pkg. unit 	Article number
6 mm steel shaft	Steel, blackened	8,000	1	10017

SUITABLE FOR STEEL · STAINLESS STEEL · NON-FERROUS METALS

MINI MAX® Stainless Steel Wire Wheel

For deburring and cleaning weld seams, paint, rust, etc. Ideal for use with the flexible shaft (see page 94).



Technical specifications

Dimensions (mm)	Mount (mm)	Wire thickness (mm)	Maximum speed (rpm)	Material	Pkg. unit 	Article number
Ø 60 x 10	6 mm steel shaft	0.2	15,000	Stainless steel 1.4310	5	10019



SUITABLE FOR STEEL · STAINLESS STEEL · NON-FERROUS METALS

MINI MAX® Stainless Steel Wire Brush



For cleaning weld seams, removing scale, paint, and rust in corners, etc. Ideal for use with the flexible shaft (see page 94).

Technical specifications

Dimensions (mm)	Mount (mm)	Maximum speed (rpm)	Material	Pkg. unit 	Article number
Ø 10 x 100	6 mm steel shaft	15,000	Stainless steel 1.4310	5	10023



MINI FIX HOOK & LOOP SYSTEM

Quick change system Ø 60 mm

SUITABLE FOR MINI HOOK & LOOP TOOLS

MINI FIX HOOK & LOOP Special Backing Pad

Quick change system Ø 60 mm

Flexible backing pad of wear-resistant polyurethane material with HOOK & LOOP fastening and centring pin to ensure that the disc runs perfectly without vibration. The ventilation slots ensure lower temperature during grinding.

Optional:

A flexible damping adapter with HOOK & LOOP fastening and a special damping layer. The 10-mm centring pin is visible for exact grinding disc centring.



Technical specifications

Item	Dimensions (mm)	Mount	Maximum speed (rpm)	Material	HOOK & LOOP material	Pkg. unit 	Article number
Special backing pad	Ø 60	Ø 6 mm steel shaft	20,000	Polyurethane plastic	Mushroom HOOK & LOOP	1	10100
Special backing pad	Ø 60	M14 thread	20,000	Polyurethane plastic	Mushroom HOOK & LOOP	1	10100b
Soft damping adapter	Ø 60	HOOK & LOOP	20,000	Foam	Harpoon HOOK & LOOP	5	10105

Which FIX HOOK & LOOP disc can you use with or without a soft damping adapter? Here are our recommendations:

With these FIX HOOK & LOOP discs, use either the backing pad only or the backing pad with soft damping adapter:



Only use the backing pad with these FIX HOOK & LOOP discs:

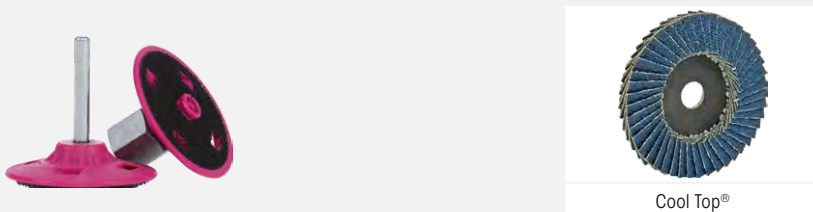

With these FIX HOOK & LOOP discs, use the support pad in conjunction with the soft damping adapter:



SUITABLE FOR STEEL · STAINLESS STEEL

MINI FIX HOOK & LOOP Cool Top® Flap Disc

Quick-change mini zircon flap disc (velcro)

Ultra-long service life, high material removal, uniform, clean results without material discolouration, adjusts ideally to the work-piece. On environmentally-friendly fibre backing material. Ideal for tool construction, small work-pieces and spot repairs.

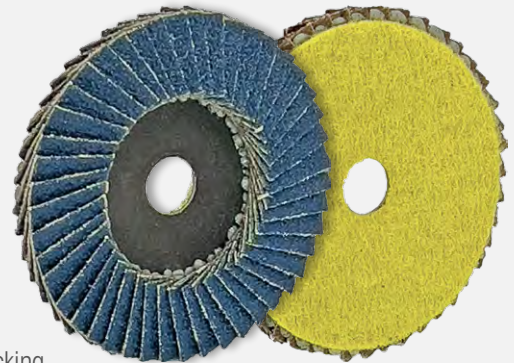

Technical specifications

Dimensions (mm)	Ideal speed (rpm)	Maximum speed (rpm)	Backing	Pkg. unit 	Grit (K)	Article number
Ø 63	6,000 – 10,000	19,000	HOOK & LOOP	20	40	10134
					60	10136
					80	10138
					120	10139



Use of a MINI FIX HOOK & LOOP Cool Top® flap disc

MINI FIX HOOK & LOOP SYSTEM

Quick change system Ø 60 mm

SUITABLE FOR STEEL · STAINLESS STEEL · NON-FERROUS METALS · WOOD · HARD PLASTICS

MINI FIX HOOK & LOOP SC Fleece Discs

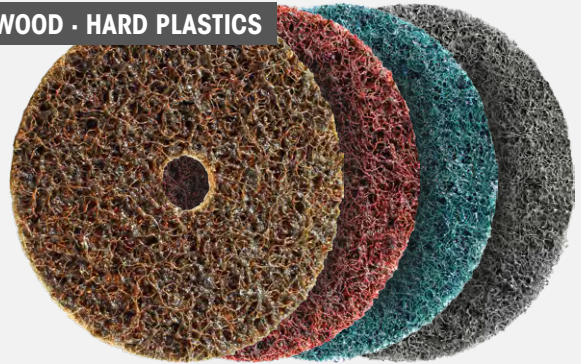

Technical surface conditioning fleece ideally suited for **deburring, fine grinding and removing minor scratches and oxide layers** on metals and other materials.

Technical specifications

Dimensions (mm)	Ideal speed (rpm)	Maximum speed (rpm)	Material	Backing	Pkg. unit 	Grit (K)	Colour (fleece)	Grit (fleece)	Article number
Ø 60	6,000 – 10,000	19,000	SC nylon fleece with reinforcing fabric	HOOK & LOOP	20	80	brown	coarse	10151
						180	red	medium	10152
						280	blue	fine	10153
						400	grey	very fine	10154



SUITABLE FOR STEEL · STAINLESS STEEL

MINI FIX HOOK & LOOP Trizact™ Disc



New type of **abrasive cloth with pyramid-shaped grit structure and additional heat-insulating layer**. Saves on several operating steps and has high material removal with **very fine results while removing scratches and spot welds**.

Ideal pre-polishing for subsequent mirror-finish polishing. Leaves very **minor surface roughness**.

Technical specifications

Dimensions (mm)	Ideal speed (rpm)	Maximum speed (rpm)	Backing	Pkg. unit 	Grit (Trizact™)	Grit (K)	Material removal (like approx. K)	Article number
Ø 60	6,000 – 10,000	19,000	HOOK & LOOP	20	A100	220	36	10141
					A65	280	40	10142
					A45	400	50	10143
					A30	600	60	10144
					A16	1200	80	10145
					A06	2000	120	10146



SUITABLE FOR ALL METALS

MINI FIX HOOK & LOOP BRIGHTEX® Polishing Discs

Berry & Sun



Polishing material that is already impregnated with BRIGHTEX® polishing paste removes the time-consuming hassle of applying pastes and creams to give untreated metal a **shadow-free mirror finish**.

Benefits at a glance

Step 1: BRIGHTEX® Berry (pre-polishing):

- For applying a rapid high-gloss polish to all metals.
- Pre-polish and main polish in one – save on additional operations.

Step 2: BRIGHTEX® Sun (main polish):

- A mirror finish that's almost like chrome plating – perfect finish.
- For a final high-gloss shine on polished metals.
- For removing any residual clouding and smears from all metals.

Please note:

After changing pastes, always remove the polish residue from the work-piece! As necessary, the backing can be re-wetted with BRIGHTEX® pastes (see page 215).

- For reconditioning high-gloss surfaces which have been polished mechanically.
- Ideal for use with polishing machines and hand-held polishing tools.
- For the best results, use **Eisenblätter care and cleaning products** for removing polish residues (see BRIGHTEX® Softclean Powder page 216, POWER CLEANER page 219).
- With centring hole for backing pads with centring pins.
- Completely new **high-tech paste formulation** for metals.
- For immediate use without additional pastes and creams!

Technical specifications

Version	Application	Dimensions (mm)	Ideal speed (rpm)	Maximum speed (rpm)	Material thickness (mm)	Backing	Pkg. unit 	Article number
Berry (pink)	High-gloss polishing	Ø 60	6,000 – 8,000	19,000	5	HOOK & LOOP	20	10118
Sun (yellow)	Mirror-finish polishing	Ø 60	6,000 – 8,000	19,000	5	HOOK & LOOP	20	10119



MINI FIX HOOK & LOOP SYSTEM

Quick change system Ø 60 mm

SUITABLE FOR ALL METALS

MINI FIX HOOK & LOOP SuperPolish Disc

Revolutionary special fleece. Used with polishing pastes and creams for a shiny mirror finish on stainless steel and non-ferrous metals which leaves no smears or shadows. Polishing pastes and cream see pages 215 and 218.

Please note: Always use a separate SuperPolish disc for each paste and cream – it is important not to mix different grit sizes.



Technical specifications

Dimensions (mm)	Ideal speed (rpm)	Maximum speed (rpm)	Material thickness (mm)	Backing	Pkg. unit 	Article number
Ø 60	6,000 – 8,000	19,000	5	HOOK & LOOP	20	10117n



SUITABLE FOR ALUMINUM · NON-FERROUS METALS · HARD PLASTICS

MINI FIX HOOK & LOOP Felt Disc

First-class Merino felt for rapid mirror finish using polishing pastes and creams that leave no scratches or smears.

Polishing pastes and cream see pages 215 and 218.

Please note: Always use a separate SuperPolish disc for each paste and cream – it is important not to mix different grit sizes.



Technical specifications

Dimensions (mm)	Ideal speed (rpm)	Maximum speed (rpm)	Material thickness (mm)	Material	Backing	Pkg. unit 	Article number
Ø 60	6,000 – 8,000	19,000	5	Merino felt	HOOK & LOOP	20	10117



SUITABLE FOR COARSE GRINDING TO A MIRROR FINISH

37
TEILE
PARTS

PINLOC Starter Set

Disc change is easy, quick, and safe –
from extra-coarse to a perfect mirror finish

In prototype construction, individual steel construction, and assembly operations, it is especially common for a wide variety of discs to be used until the desired result is achieved. The PINLOC quick change system makes it much easier for you to change your tools, since discs are attached by simply screwing them onto the PINLOC backing pad – without any other tools, such as a chuck key, whatsoever. Contains tools with three different diameters (50/60/75 mm) for work from coarse grinding (such as removing weld seams) to perfect mirror finishing on all metals.



MULTIFUNCTIONAL GRINDING

Technical specifications

Application	Can be used with	Pkg. unit 	Article number
Coarse grinding to a mirror finish	MINI MAX®, MINI MAX® 1100, MINI MAX® AKKU, straight grinders and also angle grinders with optional M14 thread backing pad	1	15001

Contents:

- 1 PINLOC backing pads 50 mm, 6 mm shaft
- 1 PINLOC HellFire® disc 50 mm
- 4 PINLOC zircon discs 50 mm
- 2 PINLOC COLDSTEEL® discs 50 mm
- 3 PINLOC SC fleece discs 50 mm
- 3 PINLOC Trizact™ discs 50 mm
- 4 PINLOC Cool Top® flap discs 63 mm
- 1 PINLOC Clean disc 63 mm
- 1 PINLOC DecoFinish disc 60 mm
- 1 PINLOC SuperPolish disc 60 mm
- 2 PINLOC BRIGHTEX® Berry & Sun discs 60 mm
- 1 PINLOC backing pad 75 mm, 6 mm shaft
- 1 PINLOC HellFire® disc 75 mm
- 4 PINLOC zircon discs 75 mm
- 2 PINLOC COLDSTEEL® discs 75 mm
- 3 PINLOC SC fleece discs 75 mm
- 3 PINLOC Trizact™ discs 75 mm



Fasten discs to the PINLOC backing pad by simply twisting them



PINLOC SYSTEM

Quick change system Ø 50 – 75 mm

SUITABLE FOR PINLOC TOOLS

PINLOC Backing Pads

Flexible backing pad with 1/4" thread mount for safely mounting all PINLOC products.

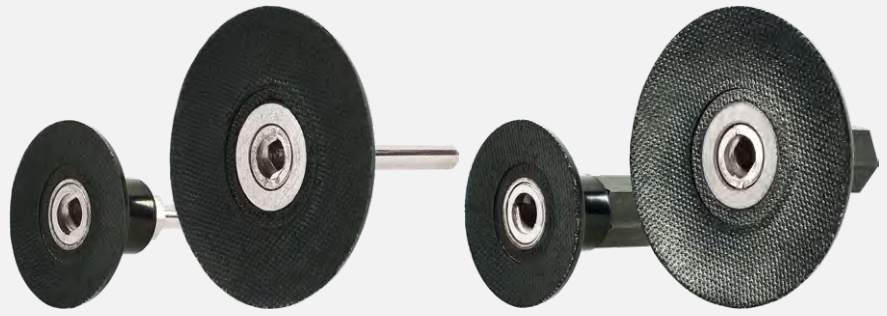

Technical specifications

Dimensions (mm)	Mount	Maximum speed (rpm)	Hardness	Disc thread	Pkg. unit 	Article number
Ø 50	Ø 6 mm steel shaft	30,000	medium	1/4"	1	15110
Ø 50	M14 thread	30,000	medium	1/4"	1	15150
Ø 75	Ø 6 mm steel shaft	20,000	medium	1/4"	1	15140
Ø 75	M14 thread	20,000	medium	1/4"	1	15160

SUITABLE FOR ALL METALS

PINLOC HellFire® Disc

Ceramic hybrid:
1 disc + 1 grit for all metals

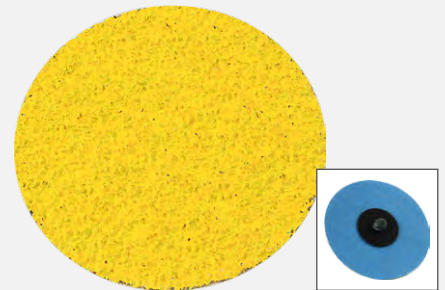

Its unparalleled, innovative ceramic hybrid technology enables it to machine any metal in record time. Material removal like 40 grit with 60 grit grinding results. Also suitable for processing aluminum.

Technical specifications

Dimensions (mm)	Disc thread	Ideal speed (rpm)	Maximum speed (rpm)	Pkg. unit 	Grit (K)	Article number
Ø 50	1/4"	10,000 – 15,000	30,000	50	Multigrain 40/60	15215
Ø 75	1/4"	10,000 – 15,000	20,000	50	Multigrain 40/60	15245



SUITABLE FOR STEEL · STAINLESS STEEL

PINLOC COLDSTEEL® Disc

High-tech ceramic fibre disc with significantly more self-sharpening edges due its ultra-fine grit and crystal structure and a corresponding material removal rate that greatly exceeds that of conventional fibre discs.

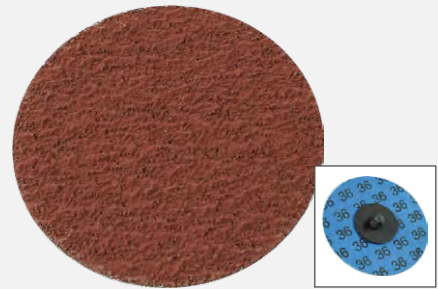

Technical specifications

Dimensions (mm)	Disc thread	Ideal speed (rpm)	Maximum speed (rpm)	Pkg. unit 	Grit (K)	Article number
Ø 50	1/4"	10,000 – 15,000	30,000	50	36	15412
					60	15416
Ø 75	1/4"	10,000 – 15,000	20,000	50	36	15442
					60	15446



SUITABLE FOR STEEL · STAINLESS STEEL

PINLOC Zircon Disc

Zirconium fibre disc with outstanding results for coarse grinding and pre-polishing. Levels weld seams and removes scratches. Ideal for work on car bodies and in motor vehicle workshops.

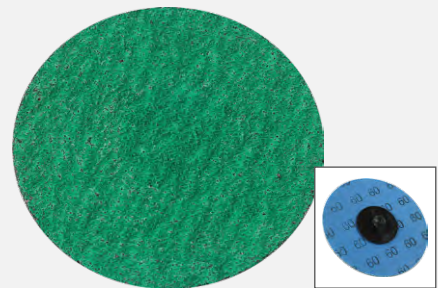

Technical specifications

Dimensions (mm)	Disc thread	Ideal speed (rpm)	Maximum speed (rpm)	Pkg. unit 	Grit (K)	Article number
Ø 50	1/4"	10,000 – 15,000	30,000	50	36	15312
					60	15316
					80	15318
Ø 75	1/4"	8,000 – 12,000	20,000	50	36	15342
					60	15346
					80	15348



PINLOC SYSTEM

Quick change system Ø 50 – 75 mm

SUITABLE FOR STEEL · STAINLESS STEEL

PINLOC Cool Top® Flap Disc

Ultra-long service life, high material removal, uniform, clean results without material discolouration, adjusts ideally to the work-piece.
On environmentally-friendly fibre backing material. Ideal for tool construction, small work-pieces, and spot repairs.

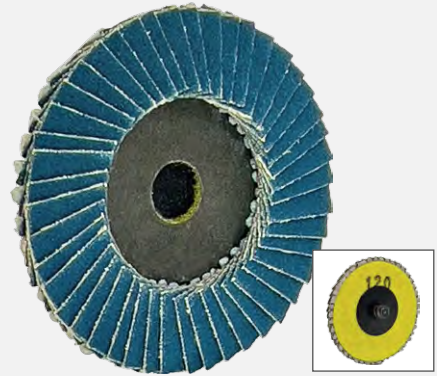

Technical specifications

Dimensions (mm)	Disc thread	Ideal speed (rpm)	Maximum speed (rpm)	Pkg. unit	Grit (K)	Article number
Ø 63	1/4"	10,000 – 15,000	19,000	20	40	15734
					60	15736
					80	15738
					120	15739



SUITABLE FOR STEEL · STAINLESS STEEL

PINLOC Trizact™ Disc

New type of **abrasive cloth with pyramid-shaped grit structure and additional heat-insulating layer**. Saves on several operating steps and has high material removal with **very fine results while removing scratches and spot welds**. Ideal pre-polishing for subsequent mirror-finish polishing. Leaves very **minor surface roughness**.

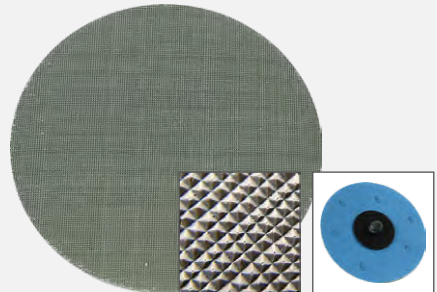

Technical specifications

Dimensions (mm)	Disc thread	Ideal speed (rpm)	Maximum speed (rpm)	Pkg. unit	Grit (K)	Article number
Ø 50	1/4"	10,000 – 15,000	30,000	50	A45	15614
					A30	15615
					A16	15616
Ø 75	1/4"	6,000 – 10,000	20,000	50	A45	15644
					A30	15645
					A16	15646



SUITABLE FOR ALL METALS · WOOD · HARD PLASTICS

PINLOC DecoFinish Disc



The open-pore design achieves **especially fine, decorative results on all metals**, hard plastics, and wood. Fine weld seams, spot welds, and deep scratches can be directly removed at the same time, depending on contact pressure. The MAGNUM® DecoFinish also means that rust and oxide layer are no obstacle to a perfect final finish. This new compact fleece can be used **for a variety of applications**. It is extremely tough and durable, does not clog pores, and has damping, cooling properties that allow perfect work-piece adaptation and soft grinding transitions.

Technical specifications

Dimensions (mm)	Disc thread	Ideal speed (rpm)	Maximum speed (rpm)	Material thickness (mm)	Pkg. unit	Article number
Ø 60	1/4"	6,000 – 8,000	19,000	13	20	15820



SUITABLE FOR STEEL · STAINLESS STEEL · NON-FERROUS METALS · WOOD · HARD PLASTICS

PINLOC SC Fleece Discs

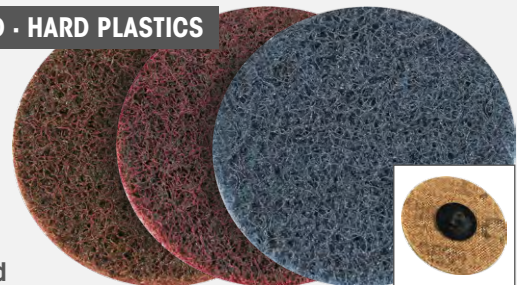

Technical surface conditioning fleece ideally suited for **deburring, fine grinding and removing minor scratches and oxide layers** on metals and other materials.

Technical specifications

Dimensions (mm)	Disc thread	Ideal speed (rpm)	Maximum speed (rpm)	Pkg. unit	Grit (K)	Colour (fleece)	Grit (fleece)	Article number
Ø 50	1/4"	8,000 – 12,000	30,000	25	80	brown	coarse	15513
					180	red	medium	15514
					280	blue	fine	15515
Ø 75	1/4"	6,000 – 10,000	20,000	25	80	brown	coarse	15543
					180	red	medium	15544
					280	blue	fine	15545



PINLOC SYSTEM

Quick change system Ø 50 – 75 mm

SUITABLE FOR ALL METALS

PINLOC BRIGHTEX® Polishing Discs

Berry & Sun



Polishing material that is already impregnated with BRIGHTEX® polishing paste removes the time-consuming hassle of applying pastes and creams to give untreated metal a **shadow-free mirror finish**.

Benefits at a glance

Step 1: BRIGHTEX® Berry (pre-polishing):

- For applying a rapid high-gloss polish to all metals.
- Pre-polish and main polish in one – save on additional operations.

Step 2: BRIGHTEX® Sun (main polish):

- A mirror finish that's almost like chrome plating – perfect finish.
- For a final high-gloss shine on polished metals.
- For removing any residual clouding and smears from all metals.

Please note:

After changing pastes, always remove the polish residue from the work-piece! As necessary, the backing can be re-wetted with BRIGHTEX® pastes (see page 215).

- For reconditioning high-gloss surfaces which have been polished mechanically.
- Ideal for use with polishing machines and hand-held polishing tools.
- For the best results, use **Eisenblätter care and cleaning products** for removing polish residues (see BRIGHTEX® Softclean Powder page 216, POWER CLEANER page 219).
- Completely new **high-tech paste formulation** for metals.
- For immediate use without additional pastes and creams!

Technical specifications

Version	Application	Dimensions (mm)	Disc thread	Ideal speed (rpm)	Maximum speed (rpm)	Material thickness (mm)	Pkg. unit 	Article number
Berry (pink)	High-gloss polishing	Ø 60	1/4"	6,000 – 8,000	19,000	5	25	15921
Sun (yellow)	Mirror-finish polishing	Ø 60	1/4"	6,000 – 8,000	19,000	5	25	15922



SUITABLE FOR ALL METALS

PINLOC SuperPolish Disc

Revolutionary special fleece. Used with polishing pastes and creams for a shiny mirror finish on stainless steel and non-ferrous metals which leaves no smears or shadows. Polishing pastes and cream see pages 215 and 218.

Please note: Always use a separate SuperPolish disc for each paste and cream – it is important not to mix different grit sizes.

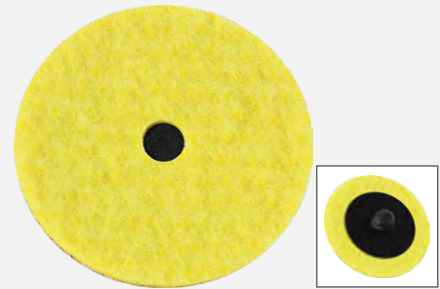

Technical specifications

Dimensions (mm)	Disc thread	Ideal speed (rpm)	Maximum speed (rpm)	Material thickness (mm)	Pkg. unit 	Article number
Ø 60	1/4"	6,000 – 8,000	19,000	5	25	15830



SUITABLE FOR ALL METALS

PINLOC CLEAN Disc

Cleans and removes pore-deep paint, rust, scale, and dirt on all materials. Effect is similar to that of sand-blasting: cleans without removing material. Ideal for car bodywork, the automotive industry, shipyards, and renovation work by commercial decorators and builders.

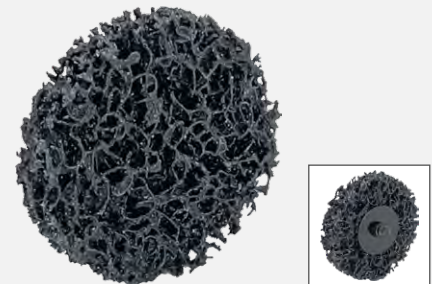

Technical specifications

Dimensions (mm)	Disc thread	Ideal speed (rpm)	Maximum speed (rpm)	Material thickness (mm)	Pkg. unit 	Article number
Ø 63	1/4"	6,000 – 8,000	19,000	13	20	15810



LINEAR GRINDING - SATIN FINISHING

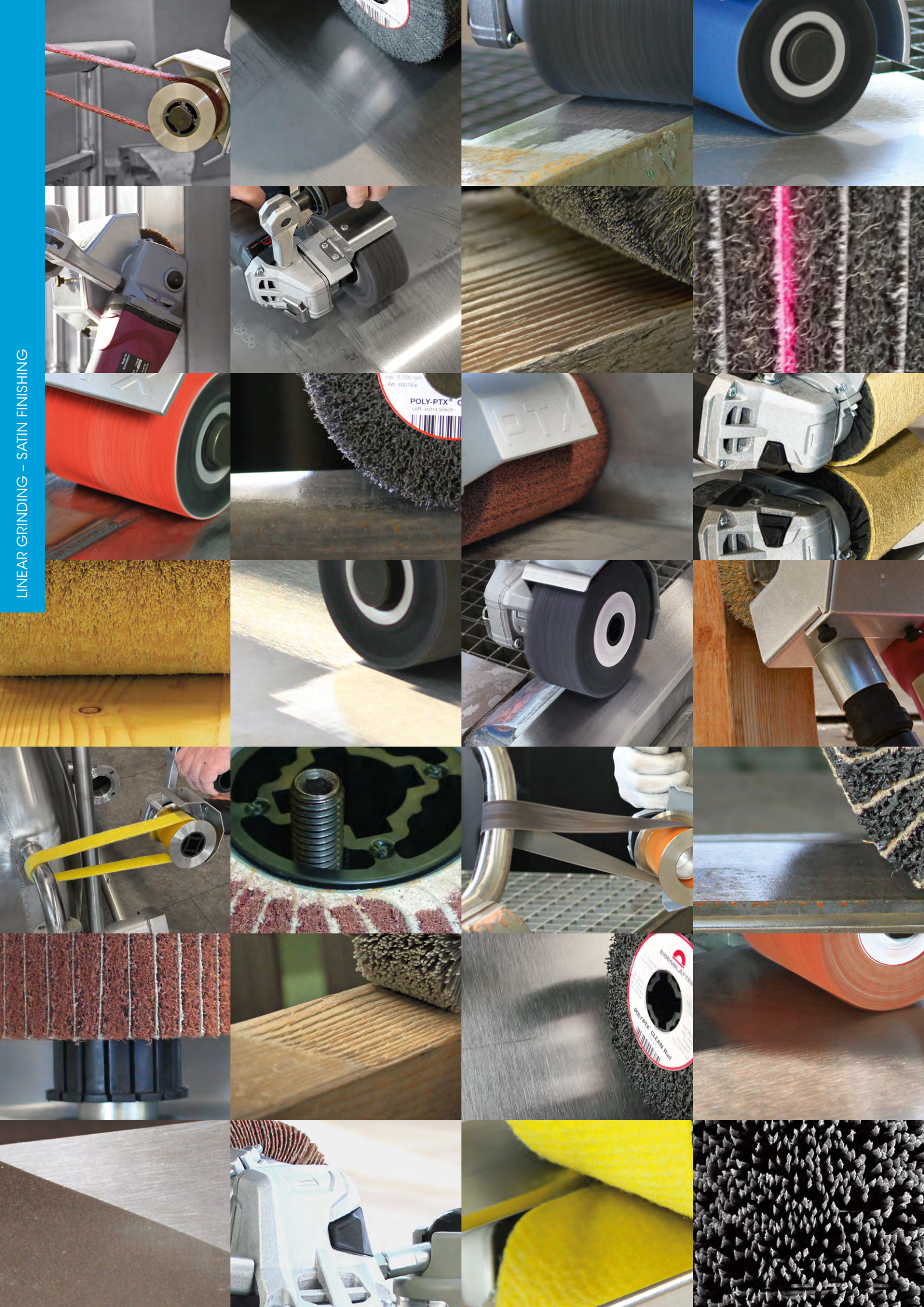

LINEAR GRINDING – SATIN FINISHING

PTX COMPACT LINEAR GRINDERS 116

NEW PTX COMPACT HT	116
NEW Accessories	118
NEW Accessory sets	119
NEW Expansion roller with M14 thread	120
NEW Grinding belt roller with M14 thread	120
NEW Flap wheel with M14 thread	121
NEW Mix wheel with M14 thread	121
NEW Fleece wheel with M14 thread	122
NEW Felt wheel with M14 thread	122
NEW Clean wheel with M14 thread	123
NEW Clean wheel soft with M14 thread	123

POLY-PTX® LINEAR GRINDERS 124

POLY-PTX® 802 HT	124
POLY-PTX® 800	126
POLY-PTX® AKKU HT	128
Accessories	130
Accessory sets	132

POLY-PTX® GRINDING WHEELS 135

CERAMIC MIX wheel	137
Mix wheel	138
CERAMIC FLAP wheel	139
Flap wheel	140
Scrubby wheel	141
Gum wheel	141
Fleece wheel Cut & Polish (S/C)	142
Fleece Top wheel	143
Fleece wheel	144
CLEAN-MIX wheel	146
Clean wheel	147
Clean wheel soft	148
Felt wheel	149
Cotton ring	149
Mirror finishing ring, medium	150
Mirror finishing ring, soft	150

POLY-PTX® TECHNICAL BRUSHES 151

Wire wheel	151
Stainless steel wire wheel	151
Bristle wheel	152
Fibre wheel	152

POLY-PTX® GRINDING SLEEVES 153

POLY-PTX® expansion rollers	153
Ceramic sleeve	154
Zircon sleeve	155
Trizact™ sleeve	156
SC fleece sleeves	157
BRIGHTEX® Berry & Sun polishing sleeves	158
SuperPolish sleeve	159
Felt sleeve	159

ECO SMART SYSTEM 160

POLY-PTX® Eco Smart Adapter	160
Eco Smart expansion roller	161
Eco Smart flap wheel	162
Eco Smart Mix wheel	163
Eco Smart fleece wheel	164

POLY-PTX® PIPE PROCESSING 165

POLY-PTX® grinding belt roller	165
POLY-PTX® special adhesive tape	166
High-quality corundum grinding belt	166
Trizact™ belt	167
SC fleece belts (T-Lock)	168
BRIGHTEX® Berry & Sun polishing belts (T-Lock) ..	169
SuperPolish belt (T-Lock)	170
Felt belt (T-Lock)	170

PTX COMPACT LINEAR GRINDERS

Mains powered machines

SUITABLE FOR ROUGH GRINDING TO POLISHING

PTX COMPACT HT Linear Grinder

The compact all-rounder for every workshop

Linear grinding, matting, satin finishing, polishing, deburring, de-rusting, de-scaling, paint removal, round tube processing and much more.

Thanks to a sophisticated **planetary gear** that provides incredibly **high power reserves** and torque, Eisenblätter is the first to offer a **light, compact universal grinder** that should not be missing in any workshop.

In addition to the well-known linear grinder from the POLY-PTX® series for working widths from 100 to 110 mm, Eisenblätter now offers a **compact version** of its **legendary linear grinding machines**, especially for roller widths up to 50 mm! Thanks to the **ideal speeds of 800 – 3,000 rpm**, almost all surface treatments can be carried out, even in "small format", **for long-term professional use**. The prerequisite for this versatility and usability of almost all possible grinding tools is of course the **high torque**, which is also guaranteed in the lower speed range by the special gear.

All **grinding and polishing tools** are equipped with an **M14 thread** and enable a very **quick and tool-free roll change**. By using a **grinding belt roller**, round pipes can be completely processed just as easily, even on **closed pipe constructions**.

Benefits at a glance

- **3 times the power, thanks to planetary gear.**
- **Ideal speed range from 800 – 3,000 rpm.**
- **Light and handy, for right and left handers (handle swivels).**
- **Easy tool change in seconds.**
- **Suitable for one- and two-handed work, thanks to its compact design.**
- **Very robust and high-quality components for a particularly long service life.**
- **Switch-off carbon brushes** to protect the motor.
- **Foam rubber handle** for "soft", vibration-neutral grinding.
- **Made in Germany.**



HT HighTorque



Sophisticated planetary gear for high power reserves and torque



PTX COMPACT LINEAR GRINDERS

Mains powered machines



LINEAR GRINDING - SATIN FINISHING

Technical specifications PTX COMPACT HT linear grinder

Plug type	Cable type	Mains connection (V ~ Hz)	Power (W)	Mount (mm)	Speed (rpm)	Weight (kg)	Pkg. unit 	Article number
EU (C+F)	Permanent connection	220 – 240 ~ 50 – 60	1,100	M14 thread	800 – 3,000	2.7	1	40401
GB (G)	Permanent connection	110 – 120 ~ 50 – 60	1,100	M14 thread	800 – 3,000	2.7	1	40401a

- Contents:**
- 1 PTX COMPACT HT basic device
 - 1 Robust, impact-resistant plastic case
 - 1 Particulate matter protection cap
 - 1 Fleece wheel with M14 thread 105 x 50 mm

Please note: Practical accessory set see page 119.

PTX COMPACT HT stainless steel grinding wheel mount (see page 118)



For the use of 50-mm-wide grinding wheels on variable-speed power tools with M14 spindles.

The ideal addition to your machine: PTX COMPACT HT accessory set (see page 119)



Tool change in no time thanks to the M14 holder and integrated M14 thread.



PTX COMPACT LINEAR GRINDERS

Accessories

SUITABLE FOR 50 MM WIDTH ROLLERS

NEW

PTX COMPACT HT stainless steel grinding wheel mount



For the use of 50-mm-wide grinding wheels on variable-speed power tools with M14 spindles. Tightening screw included in delivery. Suitable 50-mm-wide wheels see page 155.

Technical specifications

Dimensions (mm)	Mount	Maximum speed (rpm)	Pkg. unit 	Article number
Ø 19 x 50	M14 thread	6,500	1	65220



SUITABLE FOR PTX COMPACT HT

NEW

PTX COMPACT HT Accessory Set

14
TEILE
PARTS

The PTX COMPACT HT accessory set means that the right tools are always handy – in the workshop and on-site. The ideal addition to your PTX COMPACT HT for metal finishing from coarse grinding to fine grinding. Ready for most standard sheet metal working and pipe machining, including many accessory parts (machine sold separately).

Technical specifications

Application	Can be used with	Pkg. unit 	Article number
Coarse grinding to fine grinding	PTX COMPACT HT	1	40403

Contents:

- 1 Mobile tool case
- 1 Expansion roller with M14 thread
- 6 Zircon sleeves
- 1 SC fleece sleeve
- 1 Grinding belt roller with M14 thread
- 1 High-quality corundum grinding belt
- 1 SC fleece belt
- 1 Mix wheel with M14 thread
- 1 Clean wheel soft with M14 thread



LINEAR GRINDING – SATIN FINISHING

The ideal supplement for these POLY-PTX® linear grinders:

NEW



PTX COMPACT HT

p. 116

PTX COMPACT LINEAR GRINDERS

Tools with M14 thread

SUITABLE FOR SLEEVES Ø 90 X 50 MM

Expansion Roller with M14 Thread

For using grinding sleeves on the speed-controlled PTX COMPACT HT satin finishing machine. With M14 thread insert for 100% concentricity.



Technical specifications

Dimensions (diameter x width in mm x mount)	Maximum speed (rpm)	Pkg. unit 	Article number
Ø 90 x 50 x M14	5,000	1	40407



SUITABLE FOR PTX COMPACT HT

Grinding Belt Roller with M14 Thread

For belts up to 30 mm wide

Deflection roller made of **wear-resistant**, soft, grooved **Vulculan plastic** for better grip and **slip-free working** with stainless steel stop disks on the side. With vibration-damping cross groove sleeve and M14 thread insert for 100% concentricity.



Technical specifications

Dimensions (diameter x width in mm x mount)	Material	Maximum speed (rpm)	Pkg. unit 	Article number
Ø 85 x 70 x M14	Vulculan polyurethane with stainless steel flanges	6,500	1	40406



SUITABLE FOR ALL METALS · WOOD

Flap Wheel with M14 Thread

Abrasive flap wheel for surface grinding

For **removing rust, oxide layers, paint, scratches** and for **strong structuring** and satin finishing of metals. With vibration-damping cross groove sleeve and M14 thread insert for 100% concentricity.



Technical specifications

Dimensions (diameter x width in mm x mount)	Ideal speed (rpm)	Maximum speed (rpm)	Material	Pkg. unit 	Grit (K)	Article number
Ø 105 x 50 x M14	1,000 – 2,000	5,000	High-quality corundum	4	24	40430
					40	40431
					60	40432
					80	40433



SUITABLE FOR ALL METALS · WOOD

Mix Wheel with M14 Thread

Fleece abrasive flaps combo wheel

Grain-filled, **high-quality nylon fleece** with versatile **high-grade corundum abrasive fabric** for even use over the entire service life. Acts more aggressively than pure fleece wheels. With vibration-damping cross groove sleeve and M14 thread insert for 100% concentricity.



Metal: matting, satin finishing, removal of light scratches, rust, oxide, etc.
Wood: smoothing the surface, removing old paint, dirt, etc.

Technical specifications

Dimensions (diameter x width in mm x mount)	Ideal speed (rpm)	Maximum speed (rpm)	Material	Pkg. unit 	Grit (K)	Article number
Ø 105 x 50 x M14	1,000 – 2,000	5,000	High-quality corundum	4	60	40440
					80	40441
					180	40443



PTX COMPACT LINEAR GRINDERS

Tools with M14 thread

SUITABLE FOR ALL METALS · WOOD

Fleece Wheel with M14 Thread

Compact high-tech fleece roller made of compressed nylon grain fleece for industrial sanding

Very high quality fleece fabric for a particularly long service life. Creates a shadow-free industrial finish (matting, satin finishing). Also for pre-polishing, removing oxide layers as well as aligning "pre-ground" sheets and smoothing surfaces. With vibration-damping cross groove sleeve and M14 thread insert for 100% concentricity.



Technical specifications

Dimensions (diameter x width in mm x mount)	Ideal speed (rpm)	Maximum speed (rpm)	Material	Pkg. unit 	Grit (K)	Article number
Ø 105 x 50 x M14	1,000 – 2,500	5,000	Nylon fleece fabric	4	60	40450
					80	40451
					180	40452
					280	40453



SUITABLE FOR ALL METALS · HARD PLASTICS

Felt Wheel with M14 Thread

For pre-polishing and high-gloss polishing of small to medium-sized flat surfaces on non-ferrous metals up to stainless steel. First-class merino felt wheel made of continuous solid felt material with vibration-damping cross-groove sleeve and M14 thread insert for 100% concentricity. Can be used with stronger contact pressure. Polishing pastes and cream see pages 215 and 218.

Please note: Do not use different pastes or creams on the same felt wheel.



Technical specifications

Dimensions (diameter x width in mm x mount)	Ideal speed (rpm)	Maximum speed (rpm)	Material	Pkg. unit 	Article number
Ø 100 x 50 x M14	1,000 – 3,000	5,000	Merino felt	4	40470



SUITABLE FOR ALL METALS · WOOD

Clean Wheel with M14 Thread

Extra resistant nylon fleece cleaning roller

Cleaning and pore-deep removal of paint, rust, scale and dirt from all materials. Works like sandblasting, **cleans without removing material.** Ideal in the body shop, the automotive industry, in shipyards and for renovation work in the painting and building trade. With vibration-damping cross groove sleeve and M14 thread insert for 100% concentricity.



Technical specifications

Dimensions (diameter x width in mm x mount)	Ideal speed (rpm)	Maximum speed (rpm)	Pkg. unit 	Article number
Ø 115 x 50 x M14	1,000 – 2,000	5,000	2	40480



SUITABLE FOR ALL METALS · WOOD

Clean Wheel Soft with M14 Thread

Extra soft nylon fleece cleaning roller

Cleaning and pore-deep removal of paint, rust, scale and dirt from all materials. Works like sandblasting, **cleans without removing material.** Ideal in body construction, the automotive industry, in shipyards and for renovation work in Painting and building trade. Can also be used for coarse satin finishing (K 60).
Tip: Ideal for the targeted removal of scratches from already satined surfaces without reworking.
 With vibration-damping cross groove sleeve and M14 thread insert for 100% concentricity.



Technical specifications

Dimensions (diameter x width in mm x mount)	Ideal speed (rpm)	Maximum speed (rpm)	Pkg. unit 	Article number
Ø 115 x 50 x M14	1,000 – 2,000	5,000	2	40481



POLY-PTX® LINEAR GRINDERS

Mains powered machines

SUITABLE FOR ROUGH GRINDING TO POLISHING

POLY-PTX® 802 HT

The new staying power

From the inventor of the hand-held linear grinding machine:
The further development of the well-known POLY-PTX® series.

The linear grinder **POLY-PTX® 802 HT** (High Torque) offers an **unprecedented torque** and **performance profile**. Thanks to a **newly developed planetary gear**, the traction is distributed over **3 additional gears**, which **enormously increases** the **torque** and **wear resistance** of the spindle.

This makes this **professional device a long-distance runner**. The **ergonomic shaft handle** with **rubberised grip inserts** has also been **further optimised** and now offers a **balanced longitudinal guide** for an **improved surface appearance** when **grinding** and **satinising**.

The **grinding roller protective cover** has also been **significantly improved**. It is now made of **precise die-cast aluminum** and can now be easily upgraded with an **optional suction cover** with **suction nozzle**. The **suction hose guide** is now, **new, directed lengthwise** over the machine so that the suction hose can no longer impede the **grinding handling**.

An additional **pull-out polycarbonate protective cover** protects the eyes from flying particles when using **extra-wide grinding wheels up to 150 mm wide** (from our **Eco Smart** sanding roller system).



HT HighTorque



Sophisticated planetary gear for high power reserves and torque

Benefits at a glance

- **Shadow-free satin finishing, brushing, polishing of all metals (stainless steel to non-ferrous metals) to wood.**
- Removes welds, deep scratches, rust, dirt, paint and oxide layers.
- **Extremely powerful and durable motor with 1,750 watts – made in Germany.**
- New, particularly ergonomic handle for optimum guidance of the grinding wheels.
- **Maximum torque plus value retention thanks to the sophisticated planetary gear** for maximum power transmission and torque (high torque) over the entire speed range, from 820 to 3,000 rpm – with tacho-generator for constant speeds even under load.
- 19 mm **stainless steel drive shaft with double splines** over the entire spindle length for sanding rollers up to 115 mm in diameter and 100 mm (milled out wheels up to 110 mm) working width – with Eco Smart Adapter up to 150 mm working width.
- **Large range of tools** for decorative surface processing.
- The finest grinding is also possible on larger surfaces thanks to the oscillating grinding movement.
- Can also be used as a **pipe belt sander, even on closed tube constructions, with the optional sanding belt roller.**

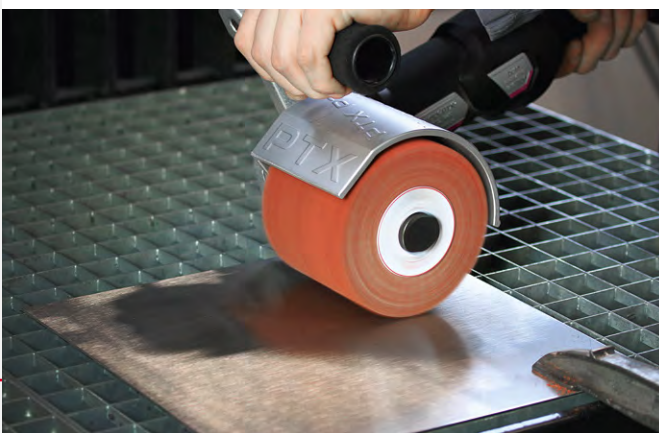



Technical specifications POLY-PTX® 802 HT basic set

Plug type	Cable type	Mains connection (V - Hz)	Power (W)	Mount (mm)	Working width (mm)	Speed (rpm)	Torque (Nm)	Weight (kg)	Pkg. unit 	Article number
EU (C+F)	Permanent connection	220 - 240 ~ 50 - 60	1,750	19 mm double keyway	max. 100 (with Eco Smart 150)	820 - 3,000	approx. 17	2.8	1	40201
GB (G)	Permanent connection	110 - 120 ~ 50 - 60	1,750	19 mm double keyway	max. 100 (with Eco Smart 150)	820 - 3,000	approx. 17	2.8	1	40201a

- Contents:**
- 1 POLY-PTX® 802 HT basic device
 - 1 Robust, impact-resistant plastic case
 - 1 Particulate matter protection cap
 - 1 POLY-PTX® tightening screw
 - 1 Fleece wheel
 - 1 Expansion roller
 - 1 Zircon sleeve
 - 1 SC fleece sleeve

Please note: Practical accessory sets from page 132.



Optional:

Suction cover with optimized hose routing (see page 130)



The ideal addition to your machine:

POLY-PTX® accessory sets (from page 132)



Optional: Ball joint holder (see page 231) for stationary attachment to work tables etc.

POLY-PTX® LINEAR GRINDERS

Mains powered machines

SUITABLE FOR ROUGH GRINDING TO POLISHING

POLY-PTX® 800

From the inventor of the linear grinder

Our variable-speed, multi-purpose linear grinder with 1,750 watts of power output and an ergonomic design is extremely versatile – even for working widths of up to 150 mm.

High torque and power reserves guarantee professional continuous operation and improved economy.



Benefits at a glance

- Grinding, **from coarse to fine.**
- **Balanced, straight-line control** without support rollers. This allows free adjustment (oscillation effect). Ensures highly decorative surfaces in satin and matt finish and industrial grinding without shadows or transitions.
- **Produces a satin finish, polishes to a mirror finish,** and improves surface finish on stainless steel, steel, and non-ferrous metals – brass, bronze, copper, aluminium, etc. – and wood.
- **Very fine grinding on large surface areas – with no shadows or streaks.**
- Removes weld seams, deep scratches, rust, dirt, paint, and oxide layers.
- **Just three steps from coarse grinding to a mirror finish** on stainless steel and non-ferrous metals.
- **The grinding belt roller allows ideal use as a pipe grinder.**
- Grinds and polishes **open and closed pipe constructions.**
- A **“T-lock system” for pipe machining** ensures safe, fast connection of fleece and felt belts to closed pipe constructions. No more hassle having to glue the belts.
- **Huge range of grinding tools** to cover almost any conceivable job.
- With a **rubberised handle for excellent control!**



Adjustable five-position handle for right and left-handed users – vibration-damping for fatigue-free work

Maintenance cover for quick carbon brush change

Convenient speed control during operation; tachogenerator for constant speed, even under load, with fine adjustment for tool optimisation

Only from Eisenblätter: Rubberised handle for optimum, non-slip handling



Knurled screw allows tool-free attachment of rollers; now with rotary protection

Optional: Eco Smart adapter for roller widths of up to 150 mm and vibration-free operation

Infinitely adjustable swivelling protective cover with option to secure the extraction cover; infinitely adjustable, retractable polycarbonate ancillary cover for grinding roller widths of up to 150 mm

Particulate matter protection clips with exchangeable filter (see page 234)

QUICK-LOCK quick-release cable fastening for fast, easy replacement of cables after damage, for example

Technical specifications POLY-PTX® 800 basic device

Plug type	Cable type	Mains connection (V – Hz)	Power (W)	Mount	Working width (mm)	Speed (rpm)	Torque (Nm)	Roller diameter (mm)	Weight (kg)	Pkg. unit	Article number
EU (C+F)	QUICK-LOCK	220 – 240 – 50 – 60	1,750	19 mm (double keyway)	max. 100 (with Eco Smart 150)	1,000 – 3,800	approx. 10	max. 115	3.3	1	40002

Scope of delivery:

- 1 POLY-PTX® 800 basic device
- 1 Robust, impact-resistant plastic case
- 1 QUICK-LOCK cable 4 m
- 1 POLY-PTX® tightening screw
- 1 Eco Smart Adapter
- 1 Fleece wheel 105 x 100 x 19 mm

The ideal addition to your machine: POLY-PTX® accessory sets (from page 132)

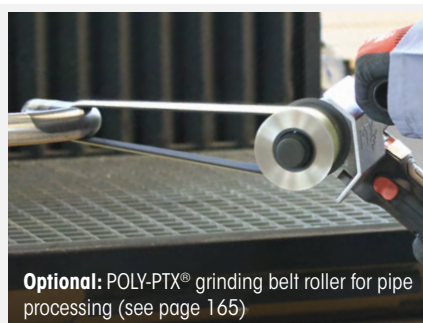

Optional: POLY-PTX® grinding belt roller for pipe processing (see page 165)



The fine dust protection clip with exchangeable filter prevents fine dust and dirt particles from penetrating the interior of the machine (see page 234).

POLY-PTX® LINEAR GRINDERS

CAS cordless machines

SUITABLE FOR ROUGH GRINDING TO POLISHING

POLY-PTX® AKKU HT

High pulling power

The **innovative** longitudinal grinding machine **POLY-PTX® AKKU HT** (High Torque) represents a **novelty** in the field of **battery-operated, hand-held grinding devices**. For the first time, a **sophisticated planetary gear** was developed for the **linear grinding application**, which has an unprecedented **torque** in order to be able to operate **all accessories** such as **grinding rollers, brushes, expansion rollers and much more** – almost like a corded, electrically powered longitudinal grinder. This **enormous pulling power** with the **smallest size** and **weight** opens up completely **new possibilities** for craftsmen **on the construction site and in industrial companies**, who **pay particular attention to cable-free work zones**. All known work processes can now also be performed wirelessly. The device offers a fixed **speed of 1,600 rpm**. This is **ideal for most tools** such as **fleece, mix and flap wheels, expansion rollers with sleeves, brushes and many more**. Incidentally, also **for pipe processing using an optional grinding belt roller**. The **full range of accessories for conventional linear grinders** such as POLY-PTX® 802 HT can now be used with the revolutionary POLY-PTX® AKKU HT. Thanks to the use of **replaceable batteries**, the device can also be used **over a long period of time** without any problems. Thanks to the **LED charge level indicator on the batteries**, you always have an **overview of the running time**. The drive shaft is made of **corrosion-free stainless steel** with the **well-known double splines**, suitable for **all Eisenblätter tools**.



Sophisticated planetary gear for high power reserves and torque

Benefits at a glance

- **Shadow-free satin finishing, brushing, polishing of all metals (stainless steel to non-ferrous metals) to wood.**
- **18-volt professional linear grinding machine.**
- Removes **weld seams, deep scratches, rust, dirt, paint, and oxide layers.**
- **Balanced, straight-line control** without support rollers. This allows the tool to be freely adjusted (oscillation effect), ensuring highly **decorative surfaces in satin and matt finish and industrial grinding without shadows or transitions.**
- **Available for the first time with planetary gear**, giving it the power of a plug-in machine of ~1,600 watts.
- **Robust cast aluminium protective cover** and vibration-damping, multi-adjustable handle.
- All **LiHD batteries** have LED charge indicators.
- **Top-performance 5.5 Ah**, optional **8.0 Ah batteries**, rotatable to **three positions by up to 270°** for convenient handling.
- **New CAS (Cordless Alliance System) battery interface: compatible with a number of drive units and machines available on the market.** Dual utility and savings potential of your battery pack included – see page 8.
- **The grinding belt roller allows ideal use as a pipe grinder.**
- A **"T-lock system"** for **pipe machining** ensures safe, fast connection of fleece and felt belts to closed pipe constructions. No more hassle having to glue the belts.



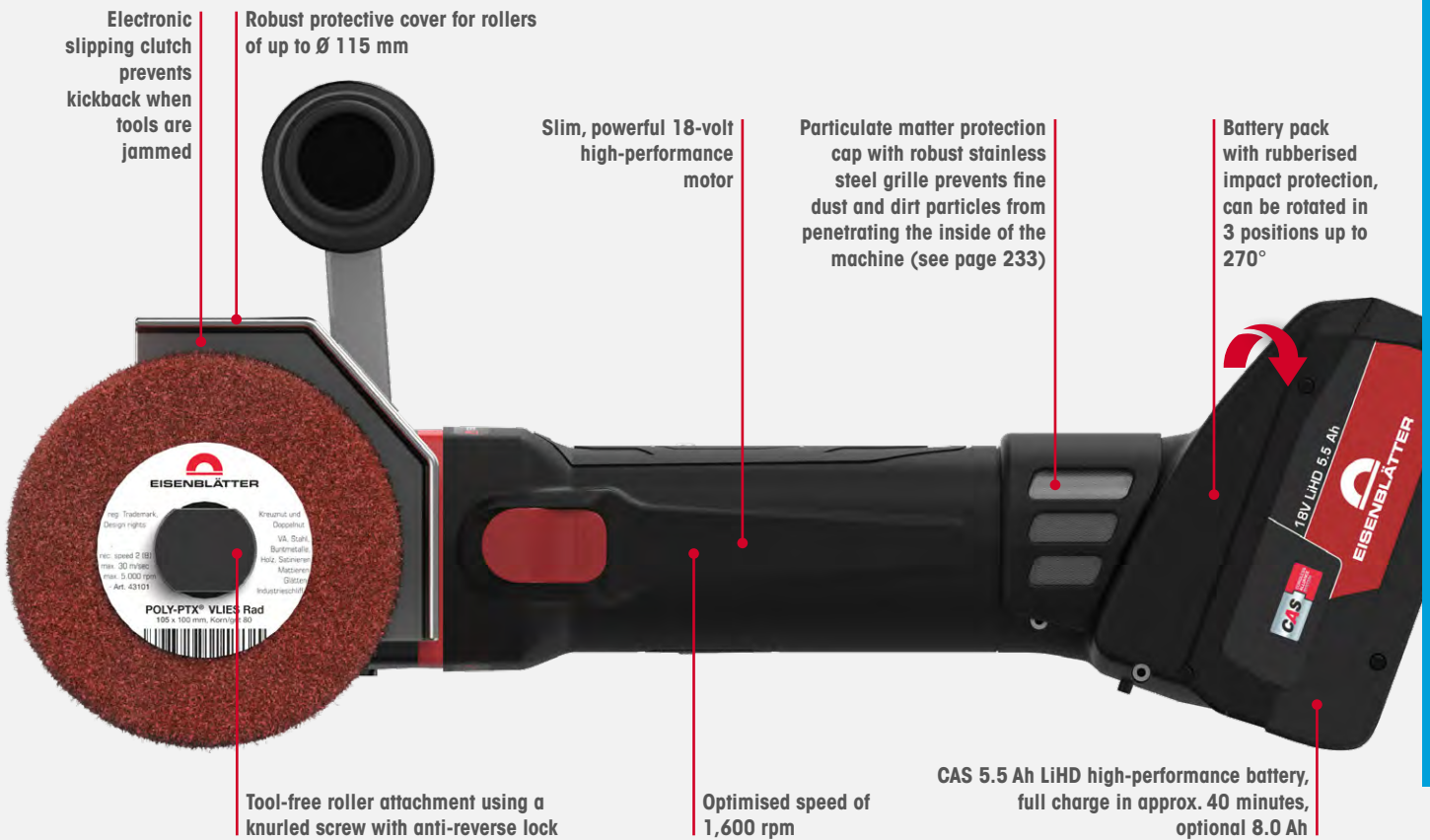

Technical specifications POLY-PTX® AKKU HT basic set / basic device (without CAS batteries, charger and accessories)

Item	Plug type	Cable type	Mains connection (V ~ Hz)	Power (V)	Mount	Working width (mm)	Speed (rpm)	Torque (Nm)	Weight (kg)	Pkg. unit	Article number
Basic set	EU (C+F)	Permanent connection	220 – 240 ~ 50 – 60	18	19 mm double keyway	max. 100	1,600	approx. 8	3.0	1	40301
Basic device	EU (C+F)	Permanent connection	220 – 240 ~ 50 – 60	18	19 mm double keyway	max. 100	1,600	approx. 8	3.0	1	40302

Scope of delivery

POLY-PTX® AKKU HT basic set:

- 1 POLY-PTX® AKKU HT basic device 18 Volt
- 1 Robust, impact-resistant plastic case
- 1 Particulate matter protection cap
- 2 LiHD batteries 18 volts with 5.5 Ah capacity (CAS)
- 1 Fast charger incl. cable (CAS)
- 1 Cast aluminium protective cover for wheels of up to Ø 115 mm
- 1 POLY-PTX® tightening screw
- 1 Set spacer rings
- 1 Fleece wheel
- 1 Expansion roller
- 1 Zircon sleeve
- 1 SC fleece sleeve
- 1 POLY-PTX® grinding belt roller
- 1 SC fleece belt
- 1 POLY-PTX® Eco Smart Adapter



Scope of delivery

POLY-PTX® AKKU HT basic device:

- 1 POLY-PTX® AKKU HT basic device 18 Volt
- 1 Robust, impact-resistant plastic case



Please note: Practical accessory sets see page 132, batteries and chargers see page 229.

Attention: No battery and no charger included!

One battery, many solutions. Cross-brand. 100% Compatibility.

POLY-PTX® LINEAR GRINDERS

Accessories

SUITABLE FOR POLY-PTX® 802 HT

POLY-PTX® 802 HT Suction Cover

for operations that generate lots of dust

Aluminium suction cover encloses the POLY-PTX® 802 HT protective cover laterally. For connecting to any commonly available industrial extractor. The new special hose guide allows work-pieces to be machined all the way to the corners. Ideal for jobs that generate a great deal of dust (such as machining aluminium or wood). Usable with rollers up to 100 mm wide, delivery includes fixing bolts for mounting on an existing POLY-PTX® 802 HT protective cover.

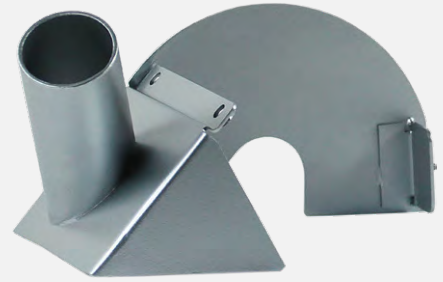

Technical specifications

Usable for roller widths up to (mm)	Can be used with	Connection dimensions		Pkg. unit 	Article number
		Exterior connection (mm)	Interior connection (mm)		
100	POLY-PTX® 802 HT	40	35	1	40205



SUITABLE FOR POLY-PTX® 800

POLY-PTX® 800 Aluminum Suction Cover

The aluminium suction cover encloses the POLY-PTX® 800 protective cover laterally. For connecting to any commonly available industrial extractor. The new parallel hose guide allows work-pieces to be machined all the way to the corners. Ideal for jobs that generate a great deal of dust (such as machining aluminium or wood). Delivery includes fixing bolts for mounting on an existing POLY-PTX® 800 protective cover.



Technical specifications

Connection dimensions		Can be used with	Usable for roller widths up to (mm)	Pkg. unit 	Article number
Exterior connection (mm)	Interior connection (mm)				
40	35	POLY-PTX® 800	100	1	40005



SUITABLE FOR 19 MM DOUBLE SPLINE SHAFTS

Set Plastic Spacer Rings

For width adjustment on 19-mm double spline shafts for brushes, rollers, polishing rings, etc.



Technical specifications

Material	Pkg. unit 	Article number
Hard plastic	1	40007

Contents:

- 2 pcs, 20 mm wide
- 1 pc, 10 mm wide
- 1 pc, 50 mm wide

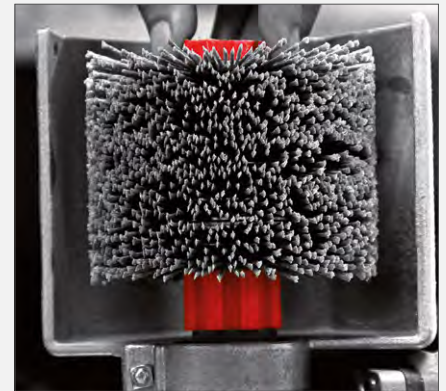

POLY-PTX® LINEAR GRINDERS

Accessory sets

SUITABLE FOR POLY-PTX® 802 HT · POLY-PTX® AKKU HT · POLY-PTX® 800

POLY-PTX® Metal Accessory Set

23
TEILE
PARTS

The POLY-PTX® metal accessory set means that the right tools are always handy – in the workshop and on-site. The ideal addition to the set for metal finishing from coarse grinding to fine grinding. Ready for most standard sheet metal working and pipe machining, including many accessory parts (machine sold separately).

Technical specifications

Application	Can be used with	Pkg. unit 	Article number
Coarse grinding to satin finish	POLY-PTX® 802 HT, POLY-PTX® AKKU HT, POLY-PTX® 800	1	40202

Contents:

- | | |
|----------------------------------|-----------------------------------|
| 1 Mobile tool case | 1 POLY-PTX® special adhesive tape |
| 6 Zircon sleeves | 1 SC fleece belt |
| 2 SC fleece sleeves | 1 Set spacer rings |
| 1 Flap wheel | 1 BRIGHTEX® microfibre cloth |
| 1 Mix wheel | 1 BRILLIANCE CLEAN 50 ml |
| 1 POLY-PTX® grinding belt roller | 1 POWER CLEANER 50 ml |
| 4 High-quality corundum belts | 1 INOX PROTECT 50 ml |



The ideal supplement for these POLY-PTX® linear grinders:



POLY-PTX® 802 HT

p. 124



POLY-PTX® AKKU HT

p. 128



POLY-PTX® 800

p. 126

SUITABLE FOR POLY-PTX® 802 HT - POLY-PTX® AKKU HT - POLY-PTX® 800

POLY-PTX® Professional Complete Accessory Set

37
TEILE
PARTS

The POLY-PTX® 802 HT professional accessory set means that the right tools are always handy – in the workshop and on-site. This high-quality professional set in a lockable, stable, impact-resistant carrying case ensures that you have everything for shadow-free industrial grinding for perfect mirror finishes on metals (surfaces and pipes), and the newly developed cleaning and preserving agents for optimal surface protection against spots and fingerprints, ready to hand (machine sold separately).

Technical specifications

Application	Can be used with	Pkg. unit 	Article number																						
Coarse grinding to a mirror finish	POLY-PTX® 802 HT, POLY-PTX® AKKU HT, POLY-PTX® 800	1	40203																						
Contents: <table border="0"> <tr> <td>1 Professional tool case (survival)</td> <td>2 SC fleece belts</td> </tr> <tr> <td>1 Set spacer rings</td> <td>4 Trizact™ belts</td> </tr> <tr> <td>4 Zircon sleeves</td> <td>2 BRIGHTEX® Berry belts</td> </tr> <tr> <td>1 SC fleece sleeve</td> <td>2 BRIGHTEX® Sun belts</td> </tr> <tr> <td>4 Trizact™ sleeves</td> <td>1 BRIGHTEX® Berry mini polishing paste</td> </tr> <tr> <td>2 BRIGHTEX® Berry sleeves</td> <td>1 BRIGHTEX® Sun mini polishing paste</td> </tr> <tr> <td>2 BRIGHTEX® Sun sleeves</td> <td>1 BRIGHTEX® Softclean Powder</td> </tr> <tr> <td>1 Flap wheel</td> <td>2 BRIGHTEX® microfibre cloths</td> </tr> <tr> <td>1 POLY-PTX® grinding belt roller</td> <td>1 POWER CLEANER 50 ml</td> </tr> <tr> <td>2 High-quality corundum belts</td> <td>1 BRILLIANCE CLEAN 500 ml</td> </tr> <tr> <td></td> <td>1 INOX PROTECT 500 ml</td> </tr> </table>		1 Professional tool case (survival)	2 SC fleece belts	1 Set spacer rings	4 Trizact™ belts	4 Zircon sleeves	2 BRIGHTEX® Berry belts	1 SC fleece sleeve	2 BRIGHTEX® Sun belts	4 Trizact™ sleeves	1 BRIGHTEX® Berry mini polishing paste	2 BRIGHTEX® Berry sleeves	1 BRIGHTEX® Sun mini polishing paste	2 BRIGHTEX® Sun sleeves	1 BRIGHTEX® Softclean Powder	1 Flap wheel	2 BRIGHTEX® microfibre cloths	1 POLY-PTX® grinding belt roller	1 POWER CLEANER 50 ml	2 High-quality corundum belts	1 BRILLIANCE CLEAN 500 ml		1 INOX PROTECT 500 ml		
1 Professional tool case (survival)	2 SC fleece belts																								
1 Set spacer rings	4 Trizact™ belts																								
4 Zircon sleeves	2 BRIGHTEX® Berry belts																								
1 SC fleece sleeve	2 BRIGHTEX® Sun belts																								
4 Trizact™ sleeves	1 BRIGHTEX® Berry mini polishing paste																								
2 BRIGHTEX® Berry sleeves	1 BRIGHTEX® Sun mini polishing paste																								
2 BRIGHTEX® Sun sleeves	1 BRIGHTEX® Softclean Powder																								
1 Flap wheel	2 BRIGHTEX® microfibre cloths																								
1 POLY-PTX® grinding belt roller	1 POWER CLEANER 50 ml																								
2 High-quality corundum belts	1 BRILLIANCE CLEAN 500 ml																								
	1 INOX PROTECT 500 ml																								

LINEAR GRINDING – SATIN FINISHING

The ideal supplement for these POLY-PTX® linear grinders:



POLY-PTX® 802 HT

p. 124



POLY-PTX® AKKU HT

p. 128



POLY-PTX® 800

p. 126

POLY-PTX® LINEAR GRINDERS

Accessory sets

SUITABLE FOR POLY-PTX® 802 HT

POLY-PTX® 802 HT Wood Accessory Set

10
TEILE
PARTS

The POLY-PTX® 802 HT wood accessory set means that the right tools are always handy – in the workshop and on-site. This set includes an additional Eco Smart adapter and contains everything you need for a brushed and rustic effect on wood surfaces and for polishing wax stains (machine sold separately).

Technical specifications

Application	Can be used with	Pkg. unit 	Article number
Rustic effects, wax stain polishing	POLY-PTX® 802 HT	1	40204

Contents:

- 1 Mobile tool case
- 1 Suction cover
- 1 Set spacer rings
- 1 Mix wheel Ø 115 x 100 mm
- 1 Bristle wheel Ø 100 x 70 mm
- 1 Bristle wheel Ø 100 x 25 mm
- 1 Bristle wheel Ø 100 x 12 mm
- 1 Wire wheel Ø 100 x 70 mm
- 1 Wire wheel Ø 100 x 25 mm
- 1 Fibre wheel Ø 100 x 100 mm



The ideal supplement for these POLY-PTX® linear grinders:



POLY-PTX® 802 HT

p. 124

Only from Eisenblätter: the balancing process for longitudinal grinding rollers

The quality of the surface finish depends crucially on the concentricity of the grinding rollers. Due to production and raw materials, there is often an imbalance in individual grinding rollers, which results in imbalance and vibrations. This is transferred to the work-piece – chatter marks and shading and thus an unclear micrograph are the result.

The balancing process

Eisenblätter wheels are balanced by a specially designed machine, similar to car tires. An imbalance is balanced with the help of a counterweight.

The result:

The roller runs smoothly. This ensures high quality grinding and satin finishing. Surfaces can be processed perfectly. There is no need for time-consuming and costly reworking, as with surface finishing with unbalanced grinding rollers.

Eisenblätter offers this benefit exclusively for a large number of products worldwide.



Balanced products are all marked with the "BALANCED" symbol.



Design-protected inner geometry effectively reduces vibrations.



Differences in quality that count: Eisenblätter grinding wheels

Very high quality in nylon fleece and grit distribution

Strongly compressed, high number of lamellas enables extreme durability – thus significantly less fleece loss on sharp edges

High concentricity due to balancing weight and additional turning of the outer contour – see page 135



Design protected, resource-saving cross groove / hollow chamber sleeve, vibration-damping (also available with internal thread M14)

Some of our grinding wheels are also available with a fleece overhang: e.g. fleece overhang with a diameter of 115 mm, grain size 60 + 80, the usable working width increases to 110 mm, which means that satin finishing in the "corner and edge area" is possible without any problems – the clamping nut is in the recessed area



SUITABLE FOR ALL METALS · WOOD

CERAMIC MIX Wheel

Remove scratches with a very attractive sheen effect



This newly developed grinding wheel creates a particularly attractive surface finish on stainless steel using an innovative ceramic recipe and our further developed fleece fabric with a 60 grit. The coordinated wear behaviour between fleece and ceramic fabric is of crucial importance here in order to achieve an even grinding pattern over the entire service life of the grinding wheel.

The CERAMIC MIX wheel meets all these requirements and creates a previously unattainable, shiny longitudinal structure, which achieves special effects on visible surfaces in particular. The result is a light and slightly glittering shine, completely free of shadows. Minor damage to the sheet metal and scratches are also eliminated at the same time. With vibration-damped sleeve for 1-way, 2-way and 4-way splined shaft, thus 100% concentricity, additionally balanced.

Technical specifications

Dimensions (diameter x width x drill bore in mm)	Ideal speed (rpm)	Maximum speed (rpm)	Material	Pkg. unit 	Grit (K)	Article number
Ø 115 x 100 x 19	1,000 – 2,000	5,000	Ceramic cloth	4	60	44561

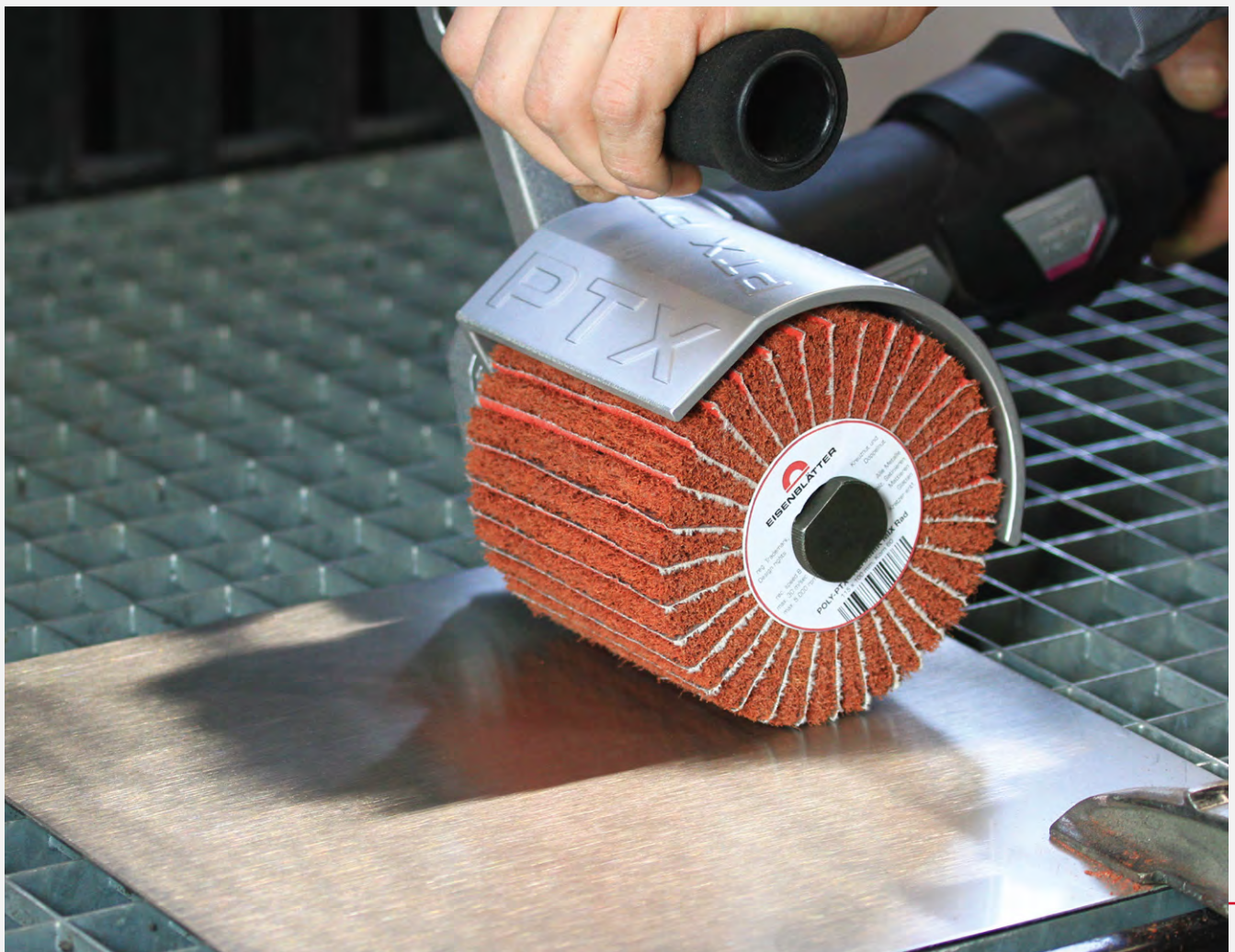

POLY-PTX® GRINDING WHEELS

Grinding and blending

SUITABLE FOR STEEL · STAINLESS STEEL · WOOD

Mix Wheel

Fleece abrasive flap combination wheel

High-quality grit-impregnated nylon fleece with versatile **high-quality corundum abrasive cloth** for uniform wear over its entire service life. It is more abrasive than pure fleece wheels. With a vibration-damping sleeve for single, double, and quadruple spline shafts, ensuring the wheel runs perfectly.

Metal: Matt finishing, satin finishing, removing minor scratches, oxide, and paint, etc.

Wood: Smoothing surfaces and removing old paint, dirt, etc.



Technical specifications

Dimensions (diameter x width x drill bore in mm)	Ideal speed (rpm)	Maximum speed (rpm)	Material	Pkg. unit 	Grit (K)	Article number
Ø 115 x 100 x 19	1,000 – 2,000	5,000	High-quality corundum	4	60	44061
					80	44101
					120	44121
					180	44181
Ø 115 x 50 x 19	1,000 – 2,000	5,000	High-quality corundum	4	60	44060
					80	44100
					120	44120
					180	44180
Ø 105 x 100 x 19	1,000 – 2,000	5,000	High-quality corundum	4	60	44061a
					80	44101a
					120	44121a
					180	44181a
Ø 105 x 50 x 19	1,000 – 2,000	5,000	High-quality corundum	4	60	44060a
					80	44100a
					120	44120a
					180	44180a



SUITABLE FOR ALL METALS

CERAMIC FLAP Wheel

Powerful material removal with a decorative sheen effect

A newly developed ceramic abrasive flap wheel of ceramic grit ensures a previously unachieved glossy look, **especially on stainless steel**. The powerful, **high-gloss linear structures** allow completely new **decorative effects!** Especially attractive for small visible surfaces. The ceramic grit has a significantly more aggressive impact and **easily removes scratches of medium severity** in a single work step. Can also be used for cleaning and removing rust and scale. The results come significantly quicker than with conventional flap wheels of aluminium oxide cloth. With a vibration-damping sleeve for single, double, and quadruple spline shafts, ensuring the wheel runs perfectly.



Technical specifications

Dimensions (diameter x width x drill bore in mm)	Ideal speed (rpm)	Maximum speed (rpm)	Material	Pkg. unit 	Grit (K)	Article number
Ø 105 x 100 x 19	1,000 – 2,000	5,000	Ceramic cloth	4	40	41540
					60	41560
					80	41580

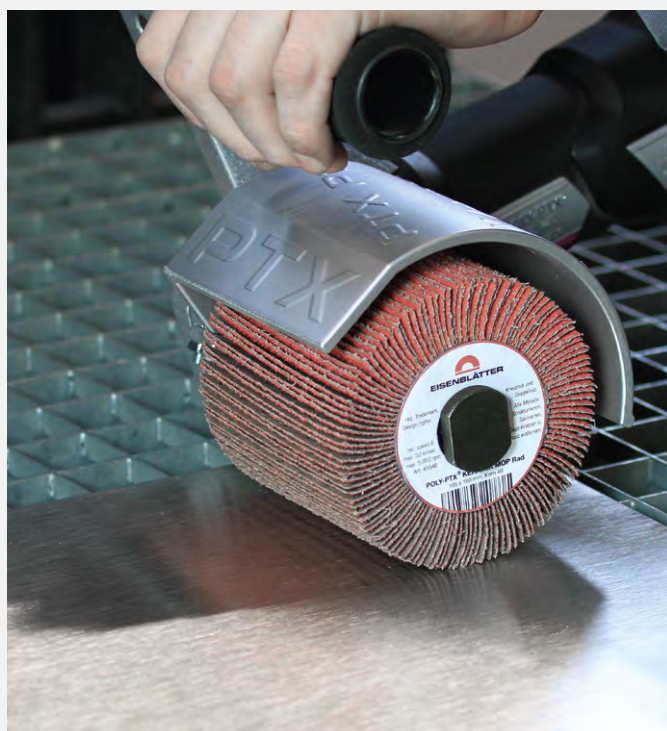

Eisenblätter ceramic self-sharpening process

The existing grinding force breaks off sintered micro-crystals, continuously giving the grit new, sharp cutting edges.

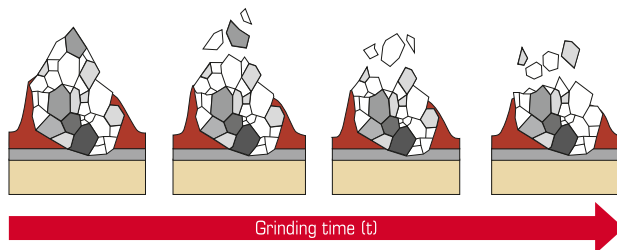

POLY-PTX® GRINDING WHEELS

Grinding and blending

SUITABLE FOR ALL METALS · WOOD

Flap Wheel

Abrasive flap wheel for surface grinding

For **removing rust, oxide layers, paint, and scratches** and for satin finishing and **applying strong structures** to metals. With a vibration-damping sleeve for single, double, and quadruple spline shafts, ensuring the wheel runs perfectly.



Technical specifications

Dimensions (diameter x width x drill bore in mm)	Ideal speed (rpm)	Maximum speed (rpm)	Material	Pkg. unit 	Grit (K)	Article number
Ø 105 x 100 x 19	1,000 – 2,000	5,000	High-quality corundum	4	40	41440
					60	41460
					80	41480
					120	41490
					180	41491
Ø 105 x 50 x 19	1,000 – 2,000	5,000	High-quality corundum	4	24	41024
					40	41040
					60	41060
					80	41080
					120	41120
					180	41180
240	41240					



Powerful longitudinal structures are created in a flash while simultaneously removing light scratches with the Eisenblätter mop wheel.

SUITABLE FOR ALL METALS · WOOD

Scrubby Wheel

The sophisticated solution for uneven surfaces

Highly flexible high-quality corundum wheel for abrasive cloth with flaps with multiple slits. For all sheet metal, including with punches and drill bores, it quickly produces linear grinding while deburring all punch or bore edges. The large number of pre-slitted cloth flaps mean that the individual flap sections are able to get perfectly into all uneven spots and round all interior edges.

This wheel can be used with many materials, such as steel, stainless steel, non-ferrous metals, hard plastics, and wood.

With a vibration-damping core for single, double, and quadruple spline shafts, ensuring the wheel runs perfectly.



Technical specifications

Dimensions (diameter x width x drill bore in mm)	Ideal speed (rpm)	Maximum speed (rpm)	Material	Pkg. unit 	Grit (K)	Article number
Ø 115 x 100 x 19	1,000 – 2,000	5,000	High-quality corundum	2	120	41314

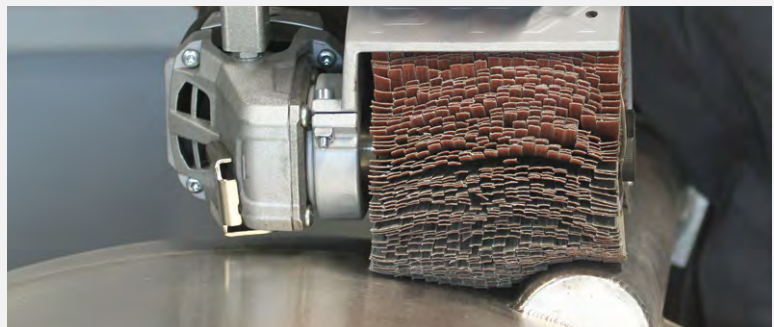

SUITABLE FOR STEEL · STAINLESS STEEL · NON-FERROUS METALS

Gum Wheel

Especially **soft gum wheel** with silicon grit for **improved work-piece adjustment**. For **eliminating minor scratches** and **removing scale**.

The result is a brightly gleaming, powerfully textured **decorative linear grind** on stainless steel and non-ferrous metals. Also used for smoothing wood fibre.



Technical specifications

Dimensions (diameter x width x drill bore in mm)	Ideal speed (rpm)	Maximum speed (rpm)	Pkg. unit 	Grit (K)	Article number
Ø 105 x 100 x 19	1,000 – 2,000	2,000	2	60	45061
				180	45181
Ø 105 x 50 x 19	1,000 – 2,000	2,000	4	60	45060
				180	45180

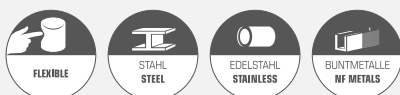

POLY-PTX® GRINDING WHEELS

Grinding and blending

SUITABLE FOR STAINLESS STEEL · NON-FERROUS METALS

Fleece Wheel Cut & Polish (S/C)



The extremely high grit content combined with a silicon carbide grit mix allows this well-known satin finish (**industrial finish grit K240-280**) to be achieved extremely quickly on stainless steel. A satin finish can be achieved without prep work **even on untreated, scratch-free stainless steel surfaces.**

Recommendation when there are scratches: Prep work with a 60 grit fleece wheel. Oxide layers are quickly removed by the high grit content. The bright finish produces a very attractive effect.

With a vibration-damping core for single, double, and quadruple spline shafts, ensuring the wheel runs perfectly.

Technical specifications

Dimensions (diameter x width x drill bore in mm)	Ideal speed (rpm)	Maximum speed (rpm)	Material	Pkg. unit 	Grit (K)	Article number
Ø 115 x 100 x 19	1,000 – 2,000	5,000	Silicon carbide fleece	2	240 – 280	43004

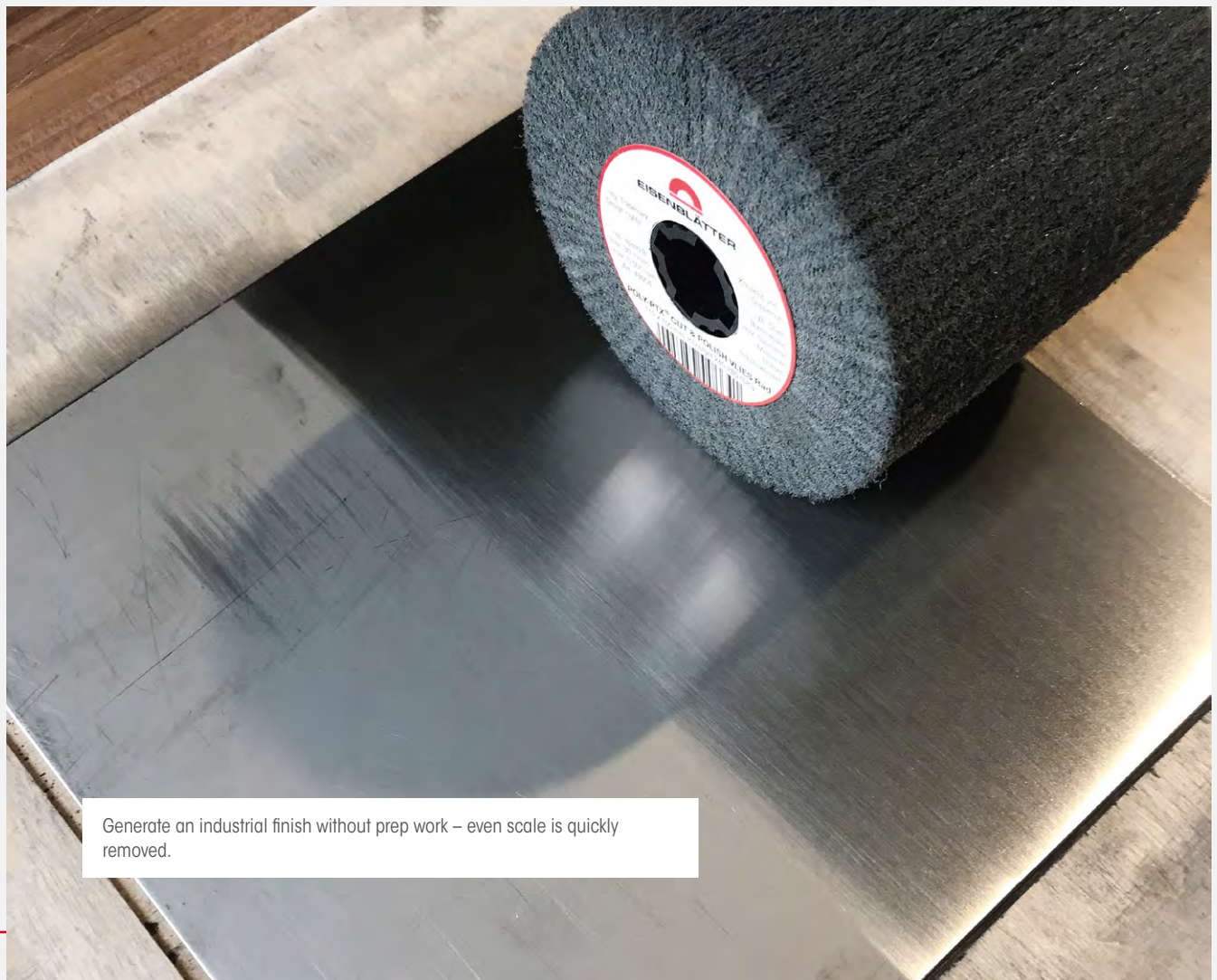

Generate an industrial finish without prep work – even scale is quickly removed.

SUITABLE FOR ALL METALS · WOOD

Fleece Top Wheel

Fleece wheel compressed with polyurethane foam. **Multiple times the service life** of pure fleece wheels. **Generates strong linear structures with a decorative sheen** and performs fine deburring of **perforated sheet metal**. With a vibration-damping sleeve for single, double, and quadruple spline shafts, ensuring the wheel runs perfectly.



Technical specifications

Dimensions (diameter x width x drill bore in mm)	Ideal speed (rpm)	Maximum speed (rpm)	Material	Pkg. unit 	Grit (K)	Article number
Ø 112 x 100 x 19	1,000 – 3,000	5,000	Foamed nylon fleece fabric	2	80	43102
					180	43103
					400	43105

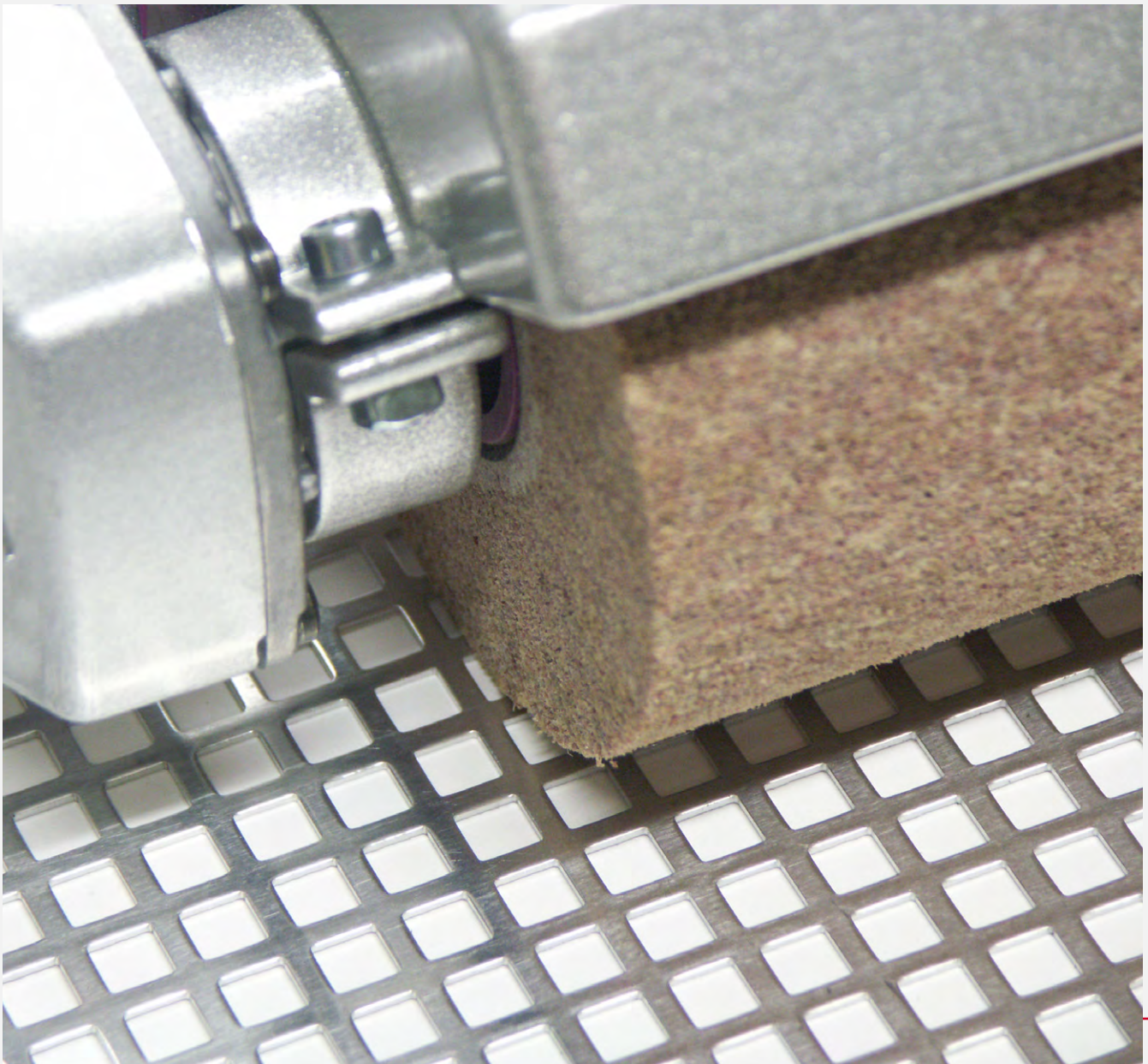

POLY-PTX® GRINDING WHEELS

Finishing and fine grinding

SUITABLE FOR STAINLESS STEEL · NON-FERROUS METALS · WOOD

Fleece Wheel

Compact high-tech fleece wheel made from compressed nylon grit fleece for industrial grinding

Very **high-quality fleece fabric** for especially long service life. Generates a shadow-free industrial finish (matt finish, satin finish). Can also be used for pre-polishing, **removing oxide layers, blending "pre-ground" sheet metal**, and smoothing surfaces. With a vibration-damping sleeve for single, double, and quadruple spline shafts, ensuring the wheel runs perfectly.

Provides the option of achieving a **working width of 110 mm** (fits all satin-finish tools) with 60, 80, and 180 grits and a diameter of **115 mm**. The tightening screw is sunk into the wheel, allowing grinding up to the edge.



Benefits at a glance

- **High-quality fleece fabric** for a particularly long service life.
- Produces a **shadow-free industrial finish** (matting, satin finishing).
- Also suitable for **pre-polishing**.
- **Ideal speed** 1,000 – 2,500 rpm.
- **Maximum speed** 5,000 rpm.
- 19 mm spline shaft mount.
- With **vibration-damped sleeve** (design protected) for 1-way, 2-way and 4-way splined shaft, resulting in **100% concentricity**.

Shadow-free industrial finish on stainless steel

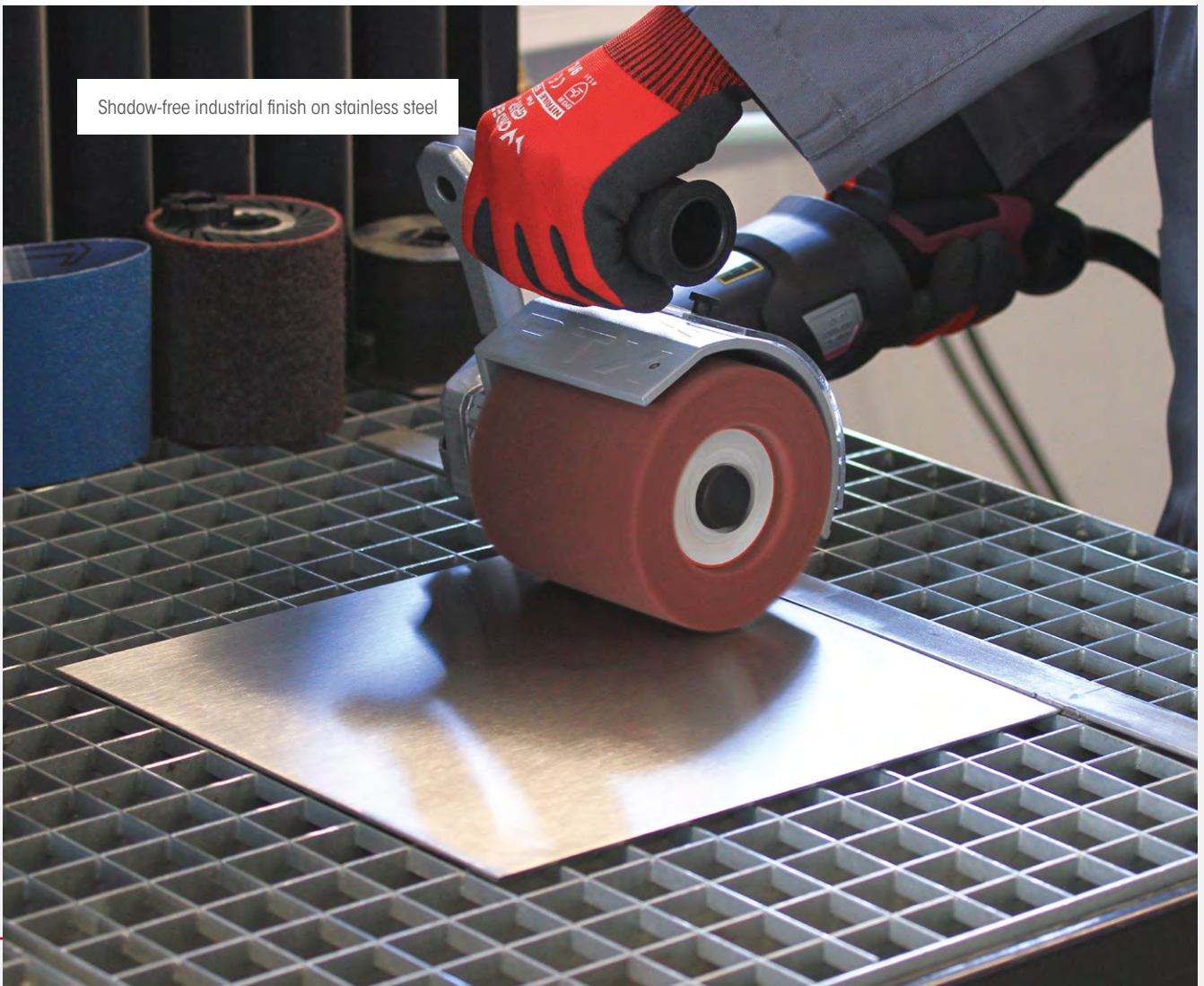

Final generation of the grinding pattern with the POLY-PTX® fleece wheel (recommendation 80 grit, for industrial grinding 240 grit) for mitre grinding.



Technical specifications

Dimensions (diameter x width x drill bore in mm)	Ideal speed (rpm)	Maximum speed (rpm)	Material	Pkg. unit 	Grit (K)	Article number
Ø 115 x 110 x 19 (an extra 10 mm wide for corner grinding)	1,000 – 2,500	5,000	Nylon fleece fabric	4	60	43061
					80	43101
					180	43181
Ø 115 x 100 x 19	1,000 – 2,500	5,000	Nylon fleece fabric	4	280	43281
					400	43401
					600	43601
					900	43901
Ø 115 x 50 x 19	1,000 – 2,500	5,000	Nylon fleece fabric	4	60	43060
					80	43100
					180	43180
					280	43280
					400	43400
					600	43600
Ø 105 x 100 x 19	1,000 – 2,500	5,000	Nylon fleece fabric	4	60	43061a
					80	43101a
					180	43181a
					280	43281a
					400	43401a
					600	43601a
Ø 105 x 50 x 19	1,000 – 2,500	5,000	Nylon fleece fabric	4	60	43060a
					80	43100a
					180	43180a
					280	43280a



SUITABLE FOR ALL METALS · WOOD

CLEAN-MIX Wheel

The solution for effectively removing mill scale and scale!

Newly designed cleaning wheel with intermediate abrasive flap layers.

For an enhanced cleaning effect and longer service life. The stabilizing abrasive flaps prevent the CLEAN material from dissipating early. The **improved grinding effect** thus achieved makes removing scales, rust, burrs, and paint **much more effective**.

The intermediate abrasive cloth layers wear uniformly with the cleaning fleece so that no disparities between the grinding components arise. The open, elastic cloth pores of the CLEAN material mean **that the product does not clog** and allows a **sand-blast-like effect on metal**. Weld seams are made clean and bright, pore-deep. **Paint can be removed quickly** and effortlessly from wood, and weathered wooden beams or planks can be renewed in record time.



Benefits at a glance

- The quickest way to remove scales, rust, burrs, etc. from metals.
- Quick cleaning and renewing of metal and wooden surfaces.
- The intermediate abrasive flap layers, tailored to the CLEAN material, ensure **uniform wear and therefore consistent grinding results**.
- With a vibration-damping sleeve for single, double, and quadruple spline shafts, ensuring the wheel runs perfectly.

Technical specifications

Dimensions (diameter x width x drill bore in mm)	Ideal speed (rpm)	Maximum speed (rpm)	Pkg. unit 	Article number
Ø 115 x 100 x 19	1,000 – 2,000	5,000	2	44018

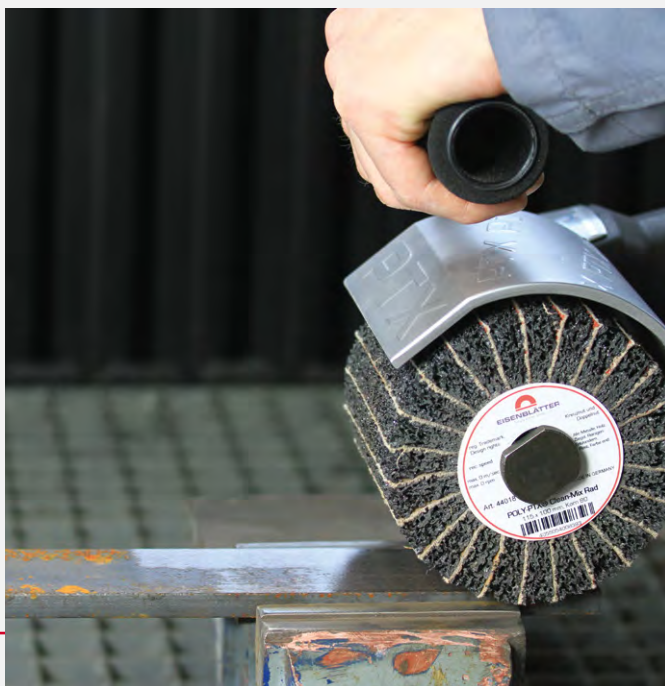

SUITABLE FOR STEEL · STAINLESS STEEL · NON-FERROUS METALS · WOOD

POLY-PTX® Clean Wheel

Ultra-resistant nylon fleece cleaning wheel



Cleans and removes pore-deep paint, rust, scale, and dirt on all materials.

The effect is similar to that of sand-blasting: **cleans without removing material**. Ideal for car bodywork, the automotive industry, shipyards, and renovation work by commercial decorators and builders. At a width of 100 mm, the overhang provides a working width of 110 mm (fits all satin-finish tools). The tightening screw is sunk into the wheel, allowing grinding up to the edge. With a vibration-damping sleeve for single, double, and quadruple spline shafts, ensuring the wheel runs perfectly.

Technical specifications

Dimensions (diameter x width x drill bore in mm)	Ideal speed (rpm)	Maximum speed (rpm)	Pkg. unit 	Article number
Ø 115 x 110 x 19 (an extra 10 mm wide for corner grinding)	1,000 – 2,000	5,000	2	40018
Ø 115 x 50 x 19	1,000 – 2,000	5,000	4	40018a



POLY-PTX® GRINDING WHEELS

Cleaning

SUITABLE FOR STEEL · STAINLESS STEEL · NON-FERROUS METALS · WOOD

POLY-PTX® Clean Wheel Soft

Ultra-soft nylon fleece cleaning wheel



Cleans and removes pore-deep paint, rust, scale, and dirt on all materials. Effect is similar to that of sand-blasting: **cleans without removing material.** Ideal for car bodywork, the automotive industry, shipyards, and renovation work by commercial decorators and builders. Can also be used for a coarse satin finish (grit 60).

Tip: Ideal for targeted elimination without rework of scratches from surfaces that have already been satin finished.

With a vibration-damping core for single, double, and quadruple spline shafts, ensuring the wheel runs perfectly.

Technical specifications

Dimensions (diameter x width x drill bore in mm)	Ideal speed (rpm)	Maximum speed (rpm)	Pkg. unit 	Article number
Ø 115 x 100 x 19	1,000 – 2,000	5,000	2	40018w
Ø 115 x 50 x 19	1,000 – 2,000	5,000	4	40018wa



The extra soft Clean Wheel Soft even adapts to round tubes.



Professional tip: Ideal for removing scratches and pre-polishing for mirror-finish polishing.

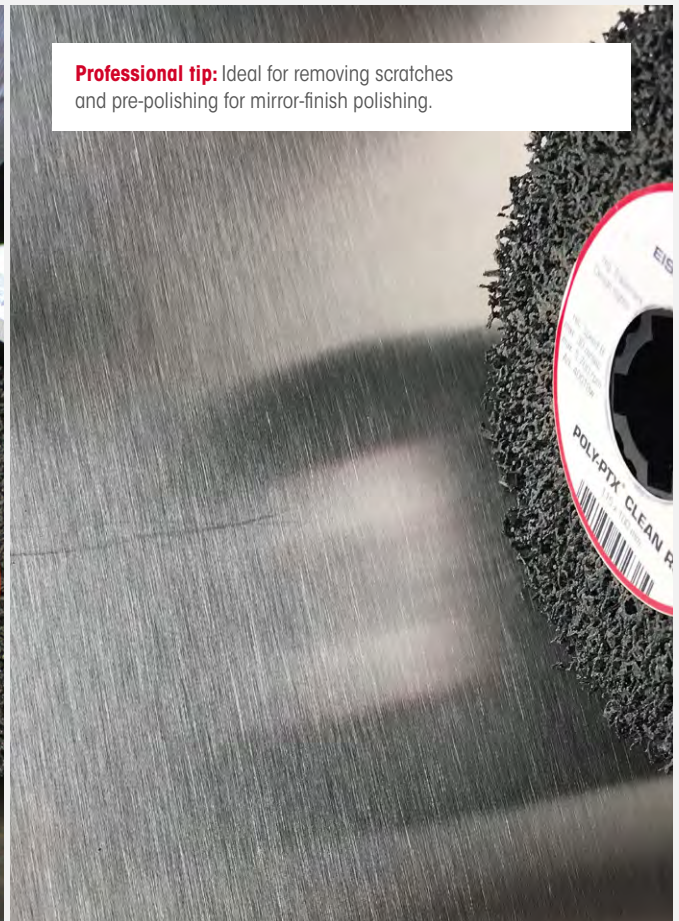

SUITABLE FOR ALUMINUM - NON-FERROUS METALS - HARD PLASTICS

Felt Wheel

For **pre-polishing and high gloss polishing** of small to medium even surfaces, from non-ferrous metals to stainless steel. **First-class Merino felt wheel of continuous felt material** with a vibration-damping sleeve for single, double, and quadruple spline shafts; ensures that the wheel runs perfectly. Can be used with great contact pressure. Polishing pastes and cream see pages 215 and 218.

Please note: Always use a separate sleeve for each paste and cream – it is important not to mix different grit sizes.



Technical specifications

Dimensions (diameter x width x drill bore in mm)	Material	Ideal speed (rpm)	Maximum speed (rpm)	Pkg. unit 	Article number
Ø 100 x 50 x 19	Merino felt	1,000 – 3,000	5,000	4	40017



SUITABLE FOR NON-FERROUS METALS

Cotton Ring

Fine **cotton rings** for polishing. **Impregnated version for non-ferrous metals.** Ideal for **high-gloss polishing** of non-ferrous metals, such as aluminium and brass. Ideal for uneven work-pieces and chequered plate. The spline shaft hole allows it to be slipped directly onto the POLY-PTX® shaft. Eight units fit perfectly on the 100 mm POLY-PTX® shaft.

Polishing pastes and cream see pages 215 and 218.

Please note: Always use a separate sleeve for each paste and cream – it is important not to mix different grit sizes.



Technical specifications

Dimensions (diameter x width x drill bore in mm)	Material	Ideal speed (rpm)	Maximum speed (rpm)	Pkg. unit 	Article number
Ø 100 x 10 x 19	Cotton (impregnated)	1,000 – 3,000	5,000	8	40019



SUITABLE FOR STAINLESS STEEL

Mirror Finishing Ring, Medium

Fine polishing rings of technical fleece material, **impregnated for stainless steel**. For **main polish** on narrow or uneven stainless steel surfaces and chequered plate. The spline shaft hole allows it to be slipped directly onto the POLY-PTX® shaft.

Eight units fit perfectly on the 100 mm POLY-PTX® shaft.

Polishing pastes and cream see pages 215 and 218.

Please note: Always use a separate sleeve for each paste and cream – it is important not to mix different grit sizes.



Technical specifications

Dimensions (diameter x width x drill bore in mm)	Material	Ideal speed (rpm)	Maximum speed (rpm)	Pkg. unit 	Article number
Ø 100 x 10 x 19	Technical fleece (impregnated)	1,000 – 3,000	5,000	8	40019m



SUITABLE FOR STAINLESS STEEL · NON-FERROUS METALS

Mirror Finishing Ring, Soft

Fine, soft polishing rings of technical fleece material. **Excellent mirror finishing effect** (final polish for metals from stainless steel to non-ferrous metals) with the same result as buff wheels. The spline shaft hole allows it to be slipped directly onto the POLY-PTX® shaft.

Eight units fit perfectly on the 100 mm POLY-PTX® shaft.

Polishing pastes and cream see pages 215 and 218.

Please note: Always use a separate sleeve for each paste and cream – it is important not to mix different grit sizes.



Technical specifications

Dimensions (diameter x width x drill bore in mm)	Material	Ideal speed (rpm)	Maximum speed (rpm)	Pkg. unit 	Article number
Ø 100 x 10 x 19	Technical fleece	1,000 – 3,000	5,000	8	40019t



SUITABLE FOR STEEL - WOOD

Wire Wheel

Braided steel brush, corrugated, for greater wire stability

Metal: For removing rust, deburring, rough grinding, and cleaning steel.

Wood: For brushing out soft growth rings and creating coarse, rustic effects.



Technical specifications

Dimensions (diameter x width x drill bore in mm)	Material	Wire thickness (mm)	Maximum speed (rpm)	Pkg. unit 	Article number
Ø 100 x 25 x 19	Steel	0.27	8,000	4	46302n
Ø 100 x 70 x 19	Steel	0.27	8,000	1	46301



SUITABLE FOR STAINLESS STEEL

Stainless Steel Wire Wheel

Durable stainless steel brush (spring steel)

For cleaning weld seams, deburring (rustproof), removing rust, rough grinding, and removing lacquer, paint, and impurities on such items as perforated stainless steel sheets.



Technical specifications

Dimensions (diameter x width x drill bore in mm)	Material	Wire thickness (mm)	Maximum speed (rpm)	Pkg. unit 	Article number
Ø 100 x 12 x 19	Stainless steel 1.4310	0.2	8,000	8	46202
Ø 100 x 25 x 19	Stainless steel 1.4310	0.2	8,000	4	46202n
Ø 100 x 70 x 19	Stainless steel 1.4310	0.2	8,000	1	46201



SUITABLE FOR ALL METALS · WOOD

Bristle Wheel

Grit-impregnated, flexible plastic brush

Metal: For rough grinding and deburring.

Wood: For generating rustic effects with soft growth ring transitions.



Technical specifications

Dimensions (diameter x width x drill bore in mm)	Material	Maximum speed (rpm)	Bristle thickness (mm)	Pkg. unit 	Article number
Ø 100 x 12 x 19	Grit-impregnated nylon	8,000	1.27	8	46102
Ø 100 x 25 x 19	Grit-impregnated nylon	8,000	1.27	4	46102n
Ø 100 x 70 x 19	Grit-impregnated nylon	8,000	1.27	1	46101



SUITABLE FOR WOOD

Fibre Wheel

Flexible fibre brush

Flexible fibre brush for polishing stained wood surfaces to create a matt sheen effect and for pore-deep dust removal and cleaning.



Technical specifications

Dimensions (diameter x width x drill bore in mm)	Material	Maximum speed (rpm)	Bristle thickness (mm)	Pkg. unit 	Article number
Ø 100 x 100 x 19	Fibre	8,000	0.4	1	46400



Working with wood

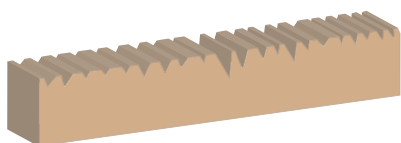

In combination with the wire wheel, the POLY-PTX® is eminently suitable for brushing out soft growth rings. A coarse rustic effect is easy to produce due to the materials used (wire brush for steel).

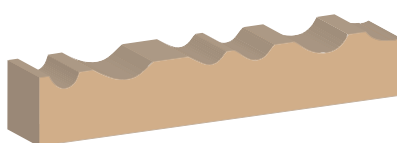

Used with the bristle wheel, a flexible, grit-impregnated plastic brush, the POLY-PTX® is the ideal tool for producing a rustic effect with a soft growth ring transition.

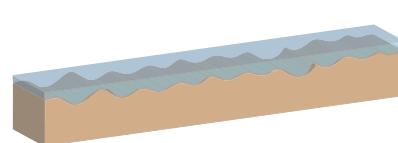

The fibre wheel guarantees stained wood surfaces are polished easily and yet with a top-quality finish. The flexible fibre brush guarantees a perfect matt sheen effect and is ideal for pore-deep cleaning and removal of dust.

SUITABLE FOR SLEEVES Ø 90 MM

POLY-PTX® Expansion Roller

A special innovation is the patented 3-fold segmented expansion roller made of soft rubber. It ensures optimum adjustment to the work-piece, improving all grinding and polishing results. Changing the sleeve is particularly easy with the patented triple-segment system.



Technical specifications

Dimensions (diameter x width x drill bore in mm)	Maximum speed (rpm)	Pkg. unit 	Article number
Ø 90 x 100 x 19	5,000	1	42002
Ø 90 x 50 x 19	5,000	1	42001



SUITABLE FOR SLEEVES Ø 90 X 100 MM

POLY-PTX® Inflatable Expansion Roller

The **individual "hardness adjustment"** of the respective zirconium, ceramic, SC fleece, Trizact™, SuperPolish, BRIGHTEX®, and felt **sleeves** makes this inflatable expansion roller a good idea. It is particularly well-suited to grinding flat surfaces and edges. It can also be inflated with a bicycle pump or similar device (for individual pressure adjustment, adapter included).



Technical specifications

Dimensions (diameter x width x drill bore in mm)	Maximum speed (rpm)	Pkg. unit 	Article number
Ø 90 x 100 x 19	5,000	1	42003



Tip for changing the sleeve

Simply place the expansion roller with the old sleeve on a smaller diameter tool (e.g. grinding belt roller) and pull it down with both hands. The sleeve can be changed in seconds.



POLY-PTX® GRINDING SLEEVES

Grinding and blending

SUITABLE FOR ALL METALS

Ceramic Sleeve

Grinding sleeves made from high-quality ceramic cloth with a service life multiples of that of a conventional grinding sleeve. For removing deep scratches, rust, scale, and weld seams. Generates bright, strong surface structures (for the coarse decorative finish). Suitable expansion roller see pages 153 and 161.



Technical specifications

Dimensions (diameter x width in mm)	Material	Pkg. unit 	Grit (K)	Article number
Ø 90 x 100	Ceramic cloth	10	40	42440
			60	42460
			80	42480



Eisenblätter ceramic self-sharpening process

The existing grinding force breaks off sintered micro-crystals, continuously giving the grit new, sharp cutting edges.

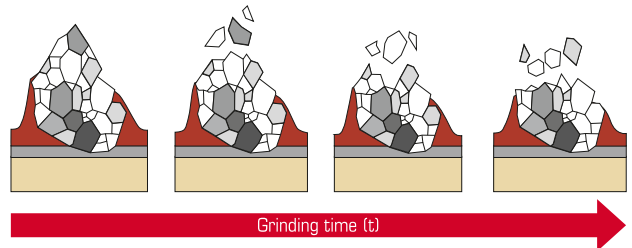

SUITABLE FOR STEEL · STAINLESS STEEL

Zircon Sleeve

Grinding sleeves of high-quality zirconium cloth for removing deep scratches, rust, scale, and weld seams (for a powerful line finish). Suitable expansion roller, see pages 120, 153 and 161.



Technical specifications

Dimensions (diameter x width in mm)	Material	Pkg. unit 	Grit (K)	Article number
Ø 90 x 100	Zirconium cloth	10	40	42040
			60	42060
			80	42080
			120	42120
			150	42150
			180	42180
Ø 90 x 50	Zirconium cloth	10	40	42301
			60	42302
			80	42303
			120	42304
			150	42305
			180	42306

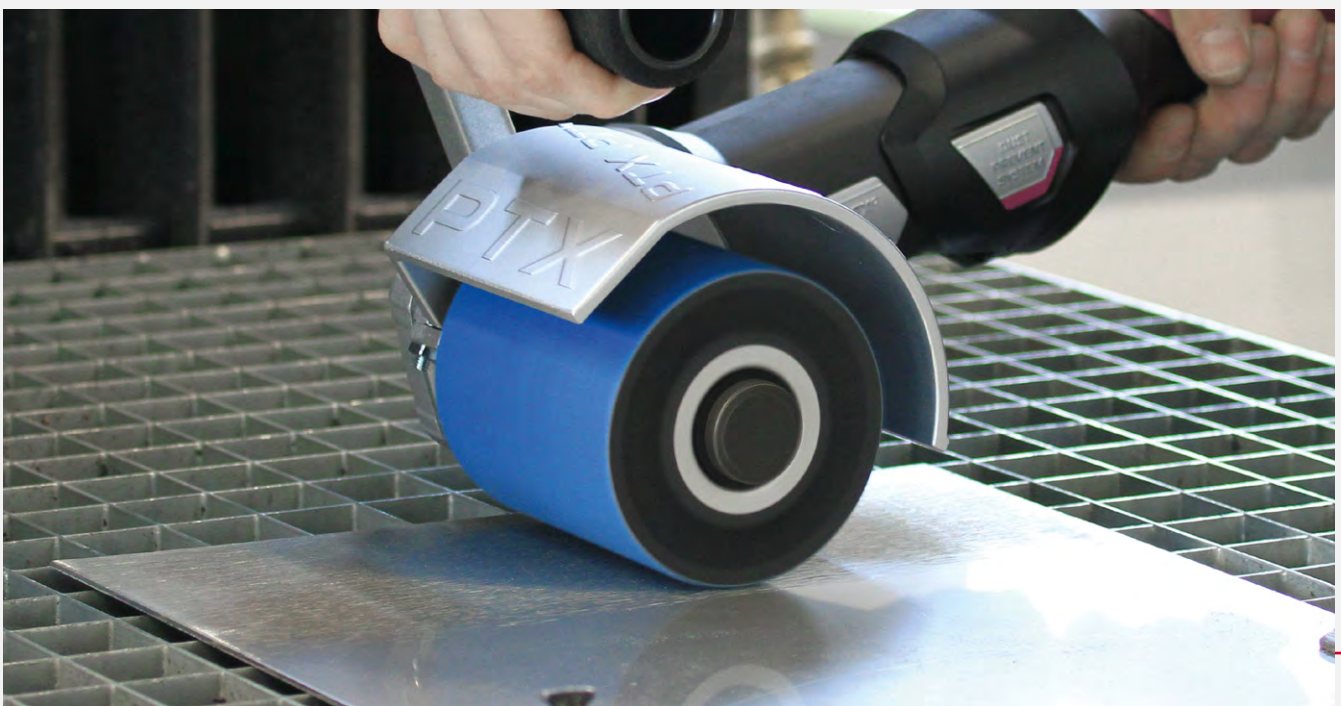

POLY-PTX® GRINDING SLEEVES

Grinding and blending

SUITABLE FOR STEEL · STAINLESS STEEL

Trizact™ Sleeve

New type of **abrasive cloth with pyramid-shaped grit structure and additional heat-insulating layer. Saves on several operating steps** and has high material removal with **very fine results while removing scratches and spot welds.** Ideal pre-polishing for subsequent mirror-finish polishing. Leaves very **minor surface roughness.**

Suitable expansion roller, see pages 120, 153 and 161.



Technical specifications

Dimensions (diameter x width in mm)	Pkg. unit 	Grit (Trizact™)	Grit (K)	Material removal (like approx. K)	Article number
Ø 90 x 100	10	A160	120	24	42280
		A100	220	36	42270
		A65	280	40	42265
		A45	400	50	42245
		A30	600	60	42230
		A16	1.200	80	42216
		A06	2.000	120	42206
		Ø 90 x 50	10	A160	120
A100	220			36	42326
A65	280			40	42325
A45	400			50	42324
A30	600			60	42323
A16	1.200			80	42322
A06	2.000			120	42321

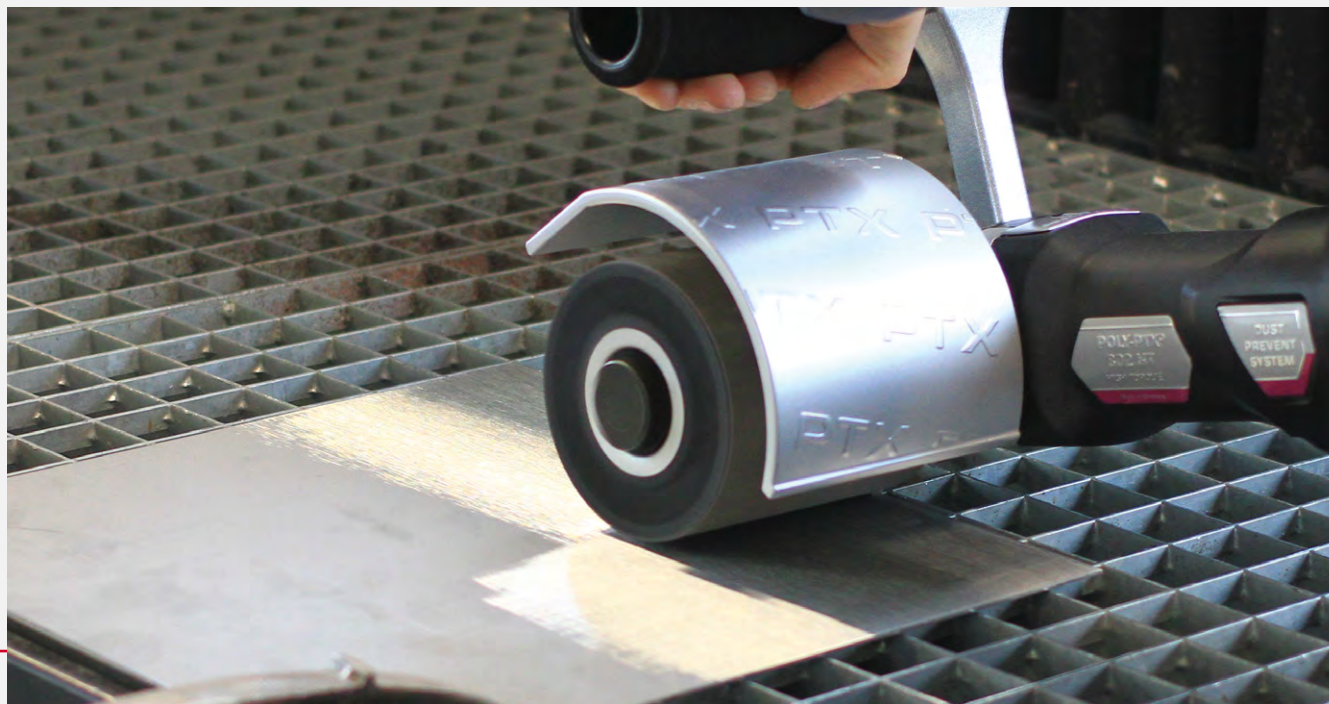

SUITABLE FOR STEEL · STAINLESS STEEL · NON-FERROUS METALS · WOOD · HARD PLASTICS

SC Fleece Sleeves



Technical surface conditioning fleece ideally suited to deburring, fine grinding, and **removing oxide layers**. Also works very well for **decorative satin finishing and linear grinding** while removing minor scratches (you may want to do rework with a POLY-PTX® fleece wheel to neutralise grinding transitions). Suitable expansion roller, see pages 120, 153 and 161.

Technical specifications

Dimensions (diameter x width in mm)	Material	Pkg. unit 	Grit (K)	Colour (fleece)	Grit (fleece)	Article number
Ø 90 x 100	SC nylon fleece with reinforcing fabric	4	80	brown	coarse	42010
			180	red	medium	42011
			280	blue	fine	42012
			400	grey	very fine	42009
Ø 90 x 50	SC nylon fleece with reinforcing fabric	4	80	brown	coarse	42311
			180	red	medium	42312
			280	blue	fine	42313
			400	grey	very fine	42314



POLY-PTX® GRINDING SLEEVES

Polishing

SUITABLE FOR ALL METALS

BRIGHTEX® Polishing Sleeves

Berry & Sun



Polishing material that is already impregnated with BRIGHTEX® polishing paste removes the time-consuming hassle of applying pastes and creams to give untreated metal a **shadow-free mirror finish**.

Can be used immediately without additional pastes and creams!

Suitable expansion roller, see pages 120, 153 and 161.

Benefits at a glance

Step 1: BRIGHTEX® Berry (pre-polishing):

- For applying a rapid high-gloss polish to all metals.
- Pre-polish and main polish in one – save on additional operations.

Step 2: BRIGHTEX® Sun (main polish):

- A mirror finish that's almost like chrome plating – perfect finish.
- For a final high-gloss shine on polished metals.
- For removing any residual clouding and smears from all metals.

Please note:

After changing pastes, always remove the polish residue from the work-piece! As necessary, the backing can be re-wetted with BRIGHTEX® pastes (see page 215).

- For reconditioning high-gloss surfaces which have been polished mechanically.
- Ideal for use with polishing machines and hand-held polishing tools.
- For the best results, use **Eisenblätter care and cleaning products** for removing polish residues (see BRIGHTEX® Softclean Powder page 216, POWER CLEANER page 219).
- Completely new **high-tech paste formulation** for metals.
- For immediate use without additional pastes and creams!

Technical specifications

Version	Application	Dimensions (diameter x width in mm)	Ideal speed (rpm)	Maximum speed (rpm)	Pkg. unit 	Article number
Berry (pink)	High-gloss polishing	90 x 100	1,000 – 3,000	5,000	2	42014
Berry (pink)	High-gloss polishing	90 x 50	1,000 – 3,000	5,000	4	42332
Sun (yellow)	Mirror-finish polishing	90 x 100	1,000 – 3,000	5,000	2	42015
Sun (yellow)	Mirror-finish polishing	90 x 50	1,000 – 3,000	5,000	4	42333



SUITABLE FOR ALL METALS

SuperPolish Sleeve

Revolutionary special fleece. Used with polishing pastes and creams for a **shiny mirror finish** on stainless steel and non-ferrous metals which leaves **no smears or shadows**.

Suitable expansion roller see pages 120, 153 and 161.

Polishing pastes and cream see pages 215 and 218.

Please note: Always use a separate sleeve for each paste and cream – it is important not to mix different grit sizes.



Technical specifications

Dimensions (diameter x width in mm)	Material thickness (mm)	Ideal speed (rpm)	Maximum speed (rpm)	Material	Pkg. unit 	Article number
Ø 90 x 100	5	1,000 – 3,000	5,000	Polishing fleece	4	42013n
Ø 90 x 50	5	1,000 – 3,000	5,000	Polishing fleece	4	42331



SUITABLE FOR ALUMINUM - NON-FERROUS METALS - HARD PLASTICS

Felt Sleeve

First-rate Merino felt sleeve, continuous throughout with no joins. For rapid mirror finish using polishing pastes and creams that leave no scratches or smears.

Suitable expansion roller see pages 153 and 161.

Polishing pastes and cream see pages 215 and 218.

Please note: Always use a separate sleeve for each paste and cream – it is important not to mix different grit sizes.



Technical specifications

Dimensions (diameter x width in mm)	Material thickness (mm)	Ideal speed (rpm)	Maximum speed (rpm)	Material	Pkg. unit 	Article number
Ø 90 x 100	5	1,000 – 3,000	5,000	Merino felt	4	42013



ECO SMART SYSTEM

Linear grinding quick clamping system

SUITABLE FOR ECO SMART TOOLS

POLY-PTX® Eco Smart Adapter

The fastest and cheapest mount for grinding rollers



The low-cost, innovative, **tool-free linear grinding quick-release system** for use on the 100 mm POLY-PTX® coupling shaft. Just push tool rollers onto the Eco Smart adapter – they will be fixed in place with the machine's running motions without any further effort. Whether the components are extra-wide rollers with a 150-mm working depth or narrow wheels with a 50-mm working depth – they will all be quickly and reliably fixed with the Eco Smart adapter. Wheels that are 50 mm wide can be fixed at any position on the shaft without spacer rings.

Benefits at a glance

- Can be used with POLY-PTX® and all linear grinding machines with Ø 19 mm spline shaft.
- Innovative tool mount for quick roller change.
- The simple Eco Smart system can be used with Eco Smart tools such as **mix and fleece wheels** with **working widths of up to 150 mm**.
- Finned rigid rubber sleeve ensures completely **vibration-free work** and keeps the **tools running perfectly**.
- Simply slide the adapter onto the spline shaft and you're ready to use Eco Smart tools.
- Guarantees immediate, **secure fixing of tools**.

Technical specifications

Dimensions (diameter x width x drill bore in mm)	Maximum speed (rpm)	Pkg. unit 	Article number
Ø 45 x 100 x 19	6,000	1	42004



Simply mount the Eco Smart adapter on the linear grinding machine's Ø 19 mm spline shaft to start using Eco Smart tools. The counter-rotating rubber flaps allow Eco Smart wheels to be secured in seconds without tools.



SUITABLE FOR SLEEVES Ø 90 X 100 MM

Eco Smart Expansion Roller

A special innovation is the patented 3-fold segmented expansion roller. Improves every grinding and polishing pattern due to the optimal work-piece adaptation. Particularly easy case change thanks to the patented triple segment system. Simply attach the Eco Smart Adapter to the 19 mm spline shaft of the linear grinding machine to clamp the Eco Smart expansion roller without tools.

Eco Smart Adapter see page 160.



Technical specifications

Dimensions (diameter x width x drill bore in mm)	Maximum speed (rpm)	Pkg. unit 	Article number
Ø 90 x 100 x 45	5,000	1	47005

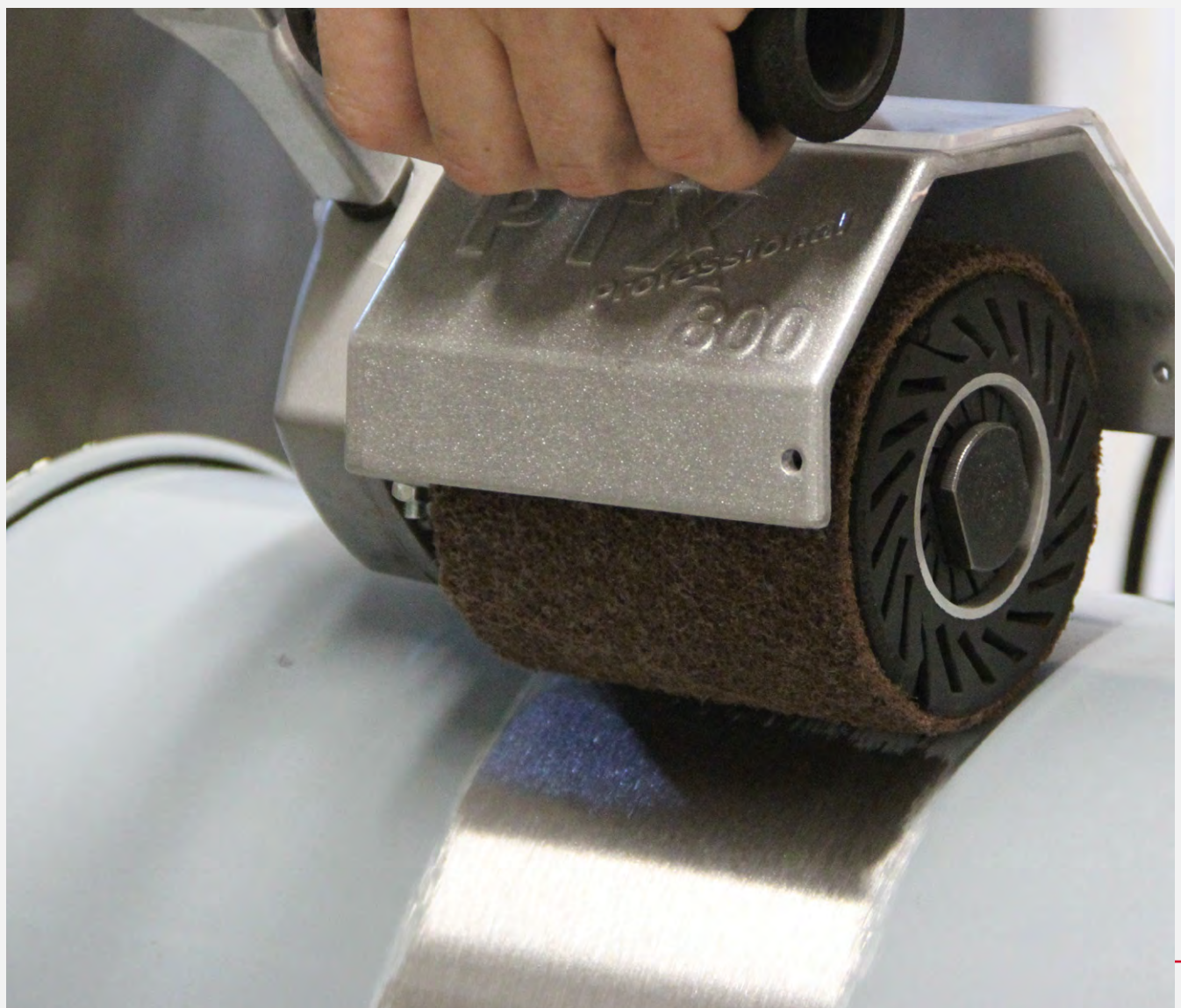
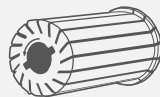

ECO SMART SYSTEM

Linear grinding quick clamping system

SUITABLE FOR ALL METALS · WOOD

Eco Smart Flap Wheel

Abrasive flap wheel for surface grinding in the Eco Smart version (eliminating the cost of the inner core, inner sleeves, or cast resin) for **removing rust, oxide layers, and scratches** and for applying **a textured and satin finish on all metals**.

Easy-to-use quick-release function for Eco Smart rollers in any position on the Eco Smart Adapter.

Eco Smart Adapter see page 160.



Technical specifications

Dimensions (diameter x width x drill bore in mm)	Material	Ideal speed (rpm)	Maximum speed (rpm)	Pkg. unit 	Grit (K)	Article number
Ø 105 x 100 x 45	High-quality corundum	1,000 – 2,000	5,000	4	40	47211
					60	47212
					80	47213
					120	47214
					180	47215
Ø 105 x 50 x 45	High-quality corundum	1,000 – 2,000	5,000	4	40	47202
					60	47204
					80	47205
					120	47206
					180	47207

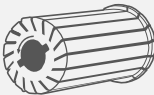

SUITABLE FOR STEEL · STAINLESS STEEL · WOOD

Eco Smart Mix Wheel

Fleece abrasive flap combination wheel

High-quality grit-impregnated nylon fleece with high-quality corundum abrasive cloth for uniform fleece and abrasive cloth wear in an Eco Smart design (eliminating costs for inner core, inner sleeves, or cast resin; working width of up to 150 mm). It is more abrasive than pure fleece wheels.

Metal: Matt finishing, satin finishing, removing minor scratches, oxide, and paint, etc.

Wood: Smoothing surfaces and removing old paint, dirt, etc.

Eco Smart Adapter see page 160.



Technical specifications

Dimensions (diameter x width x drill bore in mm)	Ideal speed (rpm)	Maximum speed (rpm)	Material	Pkg. unit 	Grit (K)	Article number
Ø 105 x 150 x 45	1,000 – 2,000	5,000	High-quality corundum	2	80	47322
					180	47323
Ø 105 x 100 x 45	1,000 – 2,000	5,000	High-quality corundum	4	60	47311
					80	47312
					180	47313
Ø 105 x 50 x 45	1,000 – 2,000	5,000	High-quality corundum	4	60	47301
					80	47302
					180	47303



The Eco Smart system allows ideal grinding all the way to corners (sheet metal upstands) since all Eco Smart tools can be placed anywhere on the Eco Smart adapter without spacer rings.

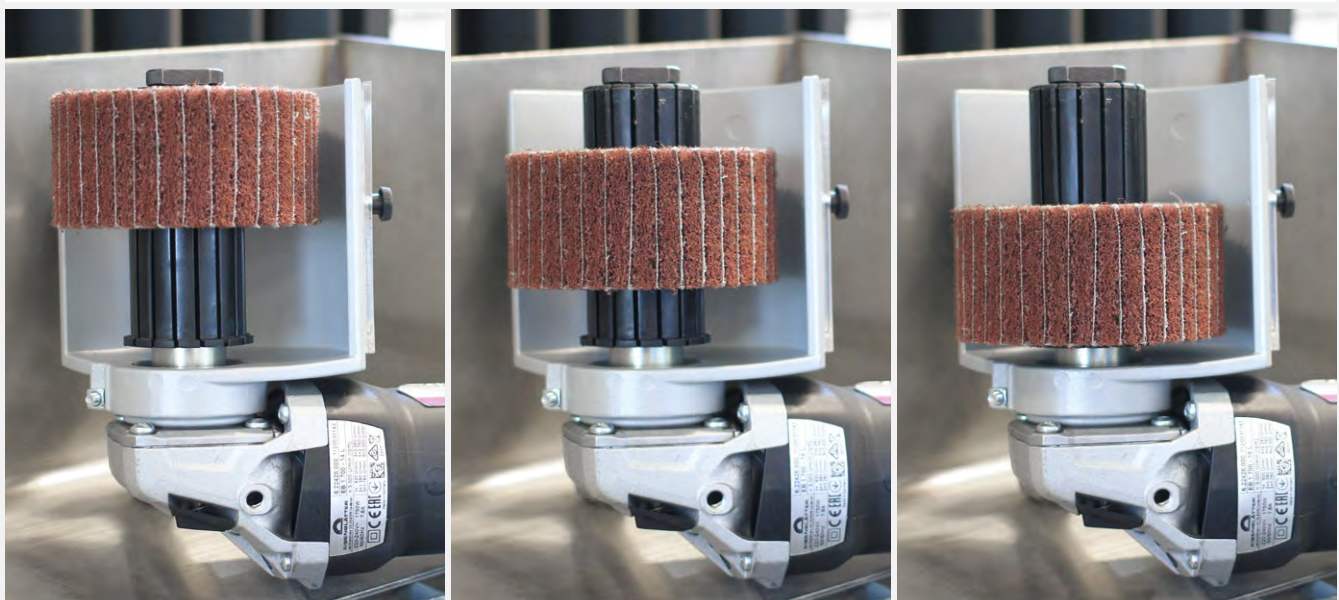

ECO SMART SYSTEM

Linear grinding quick clamping system

SUITABLE FOR STAINLESS STEEL · NON-FERROUS METALS · WOOD

Eco Smart Fleece Wheel

Compact high-tech fleece wheel of compressed nylon grit fleece for an industrial finish



High-tech fleece wheel in an Eco Smart design (eliminating costs for inner core, inner sleeves, or cast resin; working width of up to 150 mm). Generates a **shadow-free industrial finish** (matt finish, satin finish). Can also be used for pre-polishing, removing oxide layers, **blending "pre-ground" sheet metal, and smoothing surfaces.**

Eco Smart Adapter see page 160.

Technical specifications

Dimensions (diameter x width x drill bore in mm)	Ideal speed (rpm)	Maximum speed (rpm)	Material	Pkg. unit 	Grit (K)	Article number
Ø 105 x 150 x 45	1,000 – 2,000	5,000	Nylon fleece fabric	2	80	47422
					180	47423
Ø 105 x 100 x 45	1,000 – 2,000	5,000	Nylon fleece fabric	4	60	47411
					80	47412
					180	47413
					280	47414
					400	47415
Ø 105 x 50 x 45	1,000 – 2,000	5,000	Nylon fleece fabric	4	80	47402
					180	47403
					280	47404



The Eco Smart system also allows working widths of up to 150 mm!



SUITABLE FOR POLY-PTX® 802 HT · POLY-PTX® AKKU HT · POLY-PTX® 800

POLY-PTX® Grinding Belt Roller

For belts of up to 30 mm width

Grinding belt roller of **wear-resistant**, soft, fluted **Vulculan plastic** for a better grip and **no-slip work** with lateral stainless steel flanges.
With a vibration-damping sleeve for single, double, and quadruple spline shafts, ensuring the wheel runs perfectly.
Matching belts can be found from page 166 onwards.

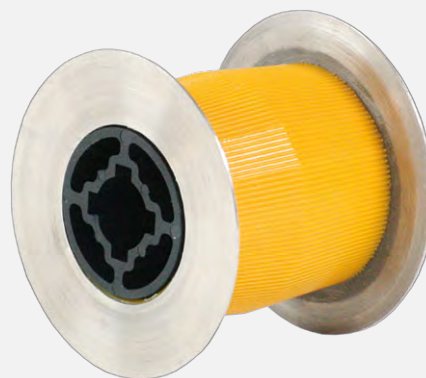

Technical specifications

Dimensions (diameter x width x drill bore in mm)	Material	Maximum speed (rpm)	Pkg. unit 	Article number
Ø 85 x 70 x 19	Vulculan polyurethane with stainless steel flanges	6,500	1	40006va



SUITABLE FOR SANDING BELTS - TRIZACT™ BELTS

POLY-PTX® Special Adhesive Tape



Heat-resistant adhesive tape with linear reinforcement for a tear-resistant hold on grinding belts. For resealing high-quality corundum and Trizact™ belts for work on closed pipe systems with grinding belt rollers.

Technical specifications

Width (mm)	Length (m)	Pkg. unit 	Article number
25	50	1	49000

TIP:

Closed grinding belts, such as the grinding belt or Trizact™ belt, are cut open for work on closed pipe constructions, placed across the pipe and taped around in an overlapping pattern (about 370°) along their entire length with our specially developed adhesive tape.

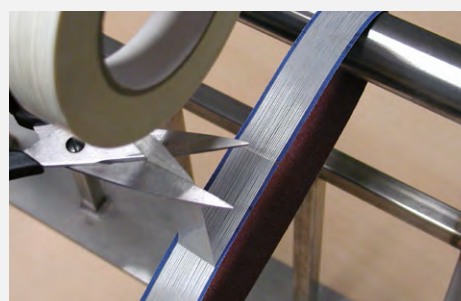
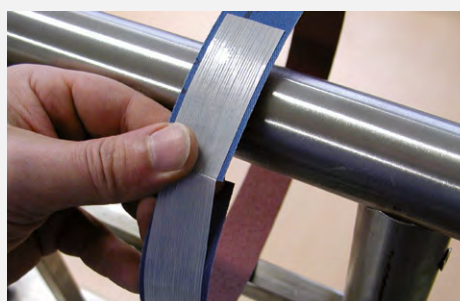

SUITABLE FOR ALL METALS

High-quality Corundum Grinding Belt



Elastically flexed high-quality corundum grinding belt for a variety of grinding work, even on tight radii. For coarse grinding, pre-grinding, smoothing, and removing burrs and rust from round pipes.

Suitable grinding belt roller see pages 120 and 165.

Technical specifications

Dimensions (mm)	Material	Pkg. unit 	Grit (K)	Article number
30 x 600	High-quality corundum	10	40	49040
			60	49060
			80	49080
			120	49120
			180	49180
			240	49240

Please note: Special adhesive tape for resealing see page 166.



SUITABLE FOR STEEL · STAINLESS STEEL

Trizact™ Belt

Ideal for removing scratches and pre-polishing for mirror-finish polishing

New type of **abrasive cloth with pyramid-shaped grit structure and additional heat-insulating layer. Saves on several operating steps** and has high material removal with **very fine results while removing scratches and spot welds**. Ideal pre-polishing for subsequent mirror-finish polishing. Leaves very **minor surface roughness**.

Suitable grinding belt roller see pages 120 and 165.

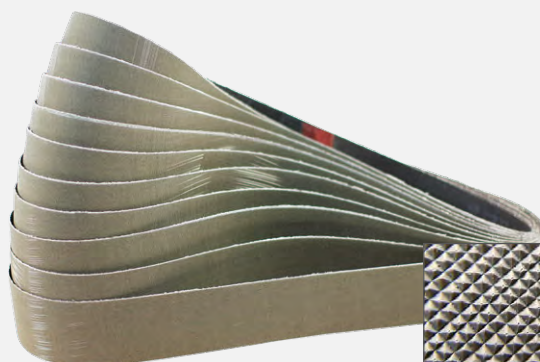

Technical specifications

Dimensions (mm)	Pkg. unit 	Grit (Trizact™)	Grit (K)	Material removal (like approx. K)	Article number
30 x 600	10	A100	220	36	49370
		A65	280	40	49365
		A45	400	50	49345
		A30	600	60	49330
		A16	1200	80	49316
		A06	2000	120	49306

Please note: Special adhesive tape for resealing see page 166.



SUITABLE FOR ALL METALS · WOOD · HARD PLASTICS

SC Fleece Belts (T-Lock)

Resealable with T-lock



Technical Surface Conditioning fleece belt with the **patented T-lock** (resealable).

For removing minor scratches and oxide layers, matt finishing, satin finishing, and deburring **"closed" pipe constructions** and railings. Suitable grinding belt roller see pages 120 and 165.

Technical specifications

Dimensions (mm)	Material	Pkg. unit 	Grit (K)	Colour (fleece)	Grit (fleece)	Article number
30 x 660	SC nylon fleece with reinforcing fabric	5	80	brown	coarse	49001
			180	red	medium	49002
			280	blue	fine	49003
			400	grey	very fine	49007

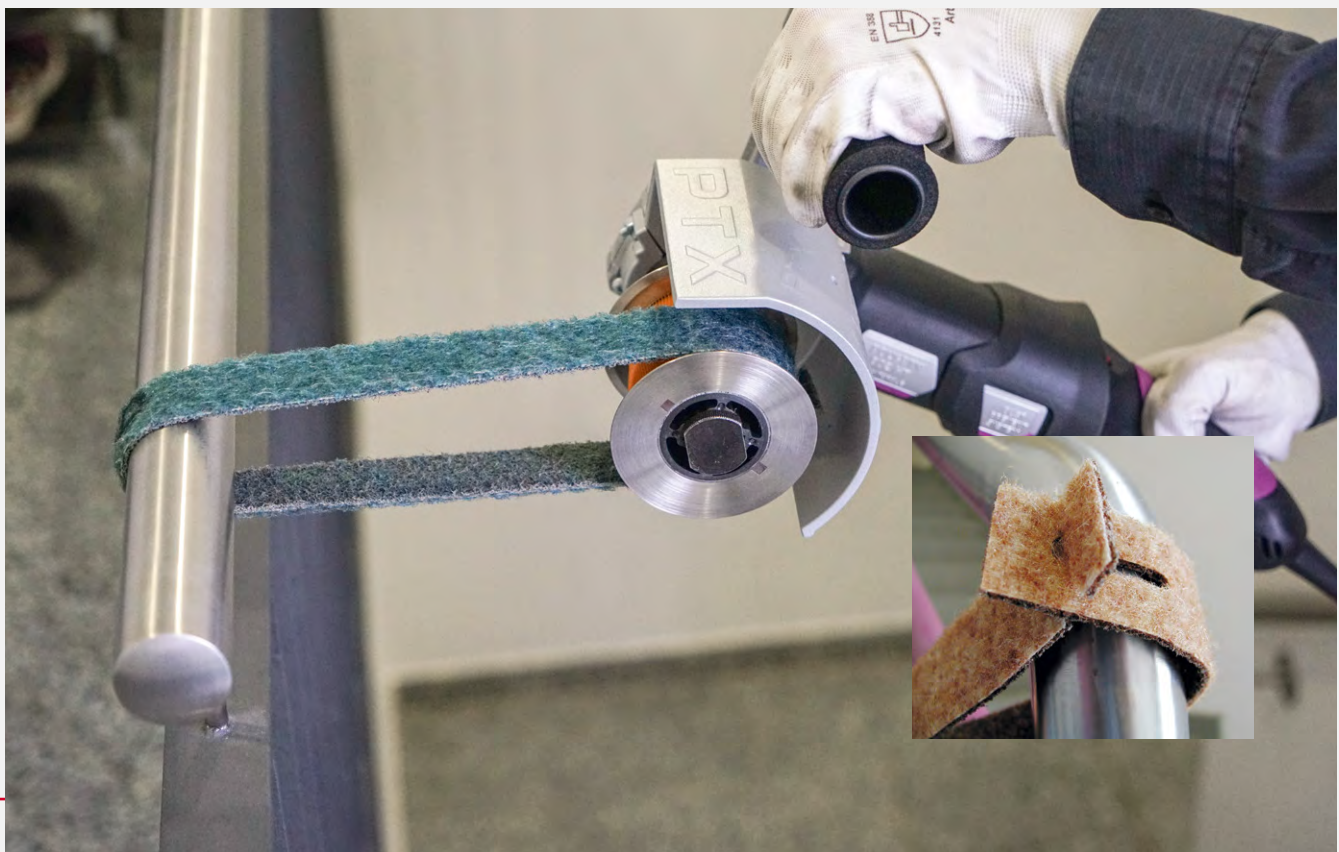

SUITABLE FOR ALL METALS

BRIGHTEX® Polishing Belts (T-Lock)

Berry & Sun

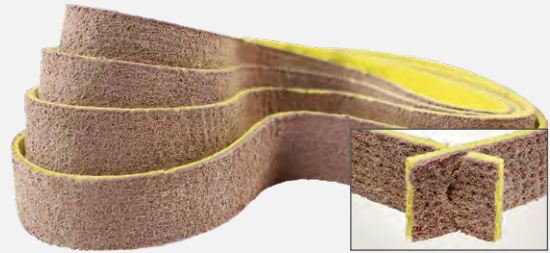

The polishing material, which is **already pre-soaked with BRIGHTEX® polishing paste**, makes the tiresome and time-consuming application of pastes and creams unnecessary and gives untreated metal **a shadow-free mirror finish. Can be used immediately** without additional pastes and creams! Re-closable strap with buttonhole closure (T-Lock) for working on "closed tube constructions". Suitable grinding belt roller see pages 120 and 165.

Benefits at a glance

Step 1: BRIGHTEX® Berry (pre-polishing):

- For applying a rapid high-gloss polish to all metals.
- Pre-polish and main polish in one – save on additional operations.

Step 2: BRIGHTEX® Sun (main polish):

- A mirror finish that's almost like chrome plating – perfect finish.
- For a final high-gloss shine on polished metals.
- For removing any residual clouding and smears from all metals.

Please note:

After changing pastes, always remove the polish residue from the work-piece! As necessary, the backing can be re-wetted with BRIGHTEX® pastes (see page 215).

- For reconditioning high-gloss surfaces which have been polished mechanically.
- Ideal for use with polishing machines and hand-held polishing tools.
- For the best results, use **Eisenblätter care and cleaning products** for removing polish residues (see BRIGHTEX® Softclean Powder page 216, POWER CLEANER page 219).
- Completely new **high-tech paste formulation** for metals.
- For immediate use without additional pastes and creams!

Technical specifications

Version	Application	Dimensions (W x L mm)	Material thickness (mm)	Pkg. unit 	Article number
Berry (pink)	High-gloss polishing	30 x 650	5	4	49005t
Sun (yellow)	Mirror-finish polishing	30 x 650	5	4	49006t



SUITABLE FOR ALL METALS

SuperPolish Belt (T-Lock)

Revolutionary special fleece

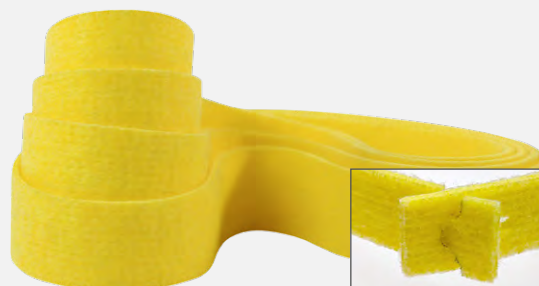

In conjunction with polishing pastes and cream, achieves a **brilliant mirror finish** on stainless steel and non-ferrous metals **without streaks or shadows**. **Resealable strap with buttonhole closure (T-Lock) for working on "closed pipe constructions"**.

Polishing pastes and cream see pages 215 and 218.

Suitable grinding belt roller see pages 120 and 165.

Please note: Always use a separate belt for each paste and cream – it is important not to mix different grit sizes.

Technical specifications

Dimensions (W x L mm)	Material thickness (mm)	Material	Pkg. unit 	Article number
30 x 650	5	Polishing fleece	5	49004t



SUITABLE FOR ALUMINUM - NON-FERROUS METALS - HARD PLASTICS

Felt Belt (T-Lock)

Resealable with T-Lock



First-class Merino felt belt with patented T-Lock (re-closable), can be used on both sides.

For quick **mirror finishing of "closed" pipe constructions** and railings, from non-ferrous metals to stainless steel.

Suitable for hard plastics as well.

Polishing pastes and cream see pages 215 and 218.

Suitable grinding belt roller see pages 120 and 165.

Please note: Always use a separate belt for each paste and cream – it is important not to mix different grit sizes.

Technical specifications

Dimensions (W x L mm)	Material thickness (mm)	Material	Pkg. unit 	Article number
30 x 660	5	Merino felt	5	49004



BELT GRINDING

APPLICATION OVERVIEW 172

BELT SANDERS 174

NEW TOPRAIL 1100 HT	174
ROHR MAX® 802 HT	176
ROHR MAX® AKKU	178
ROHR SNIPER® 802 HT	180
NEW BAND-IT 1100	182
BAND-IT AKKU	183
GLADIUS® 1802 HT	186
NEW Accessories	188
Accessory sets	190

GRINDING BELTS 193

Zircon belt	193
High-quality corundum belt	194
SC fleece belts	195
Trizact™ belt	196

POLISHING BELTS 197

BRIGHTEX® Berry & Sun	197
SuperPolish belt	198
Felt belt	199



Application overview

POLY-PTX® 802 HT · POLY-PTX® AKKU HT · PTX COMPACT HT · POLY-PTX® 800

Belt dimensions:

30 x 600 mm
30 x 660 mm (T-Lock)

Pipe diameter:
Ø 10 – 130 mm

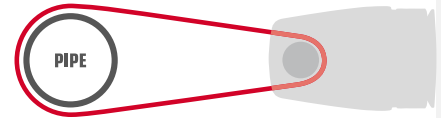
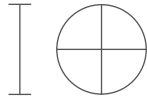

Pages 124 / 128 / 116 / 126

TOPRAIL 1100 HT

Belt dimensions:

40 x 780 mm

Pipe diameter:
ideal Ø 20 – 80 mm
maximum Ø 130 mm

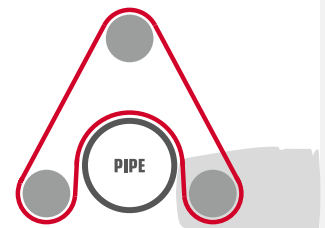
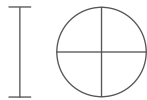

Page 174

ROHR MAX® 802 HT

Belt dimensions:

40 x 780 mm

Pipe diameter:
Ø 40 – 130 mm

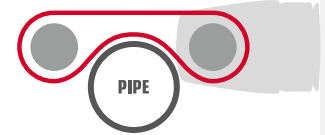

Page 176

ROHR MAX® AKKU

Belt dimensions:

30 x 533 mm

Pipe diameter:
Ø 20 – 80 mm

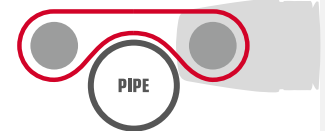

Page 178

ROHR SNIPER® 802 HT

Belt dimensions:

40 x 780 mm

Pipe diameter:
Ø 25 – 70 mm

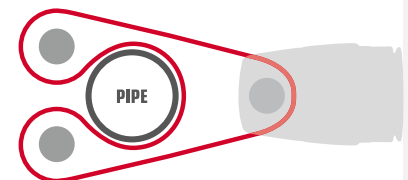

Page 180

Application overview

BAND-IT 1100 - BAND-IT AKKU

Belt dimensions:
5 / 9 x 533 mm

All sizes,
flat surfaces

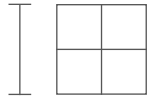

Pages 182 / 184

GLADIUS® 1802 HT

Belt dimensions:
40 x 780 mm

All sizes,
flat surfaces

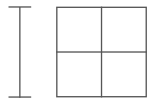

Page 186

Suitable grinding belt rolls for POLY-PTX® linear grinders:



POLY-PTX® grinding belt roller

p. 165

NEW



PTX COMPACT HT grinding belt roller

p. 120

Suitable grinding belts:

Zircon grinding belt p. 193

Trizact™ belt p. 196

BRIGHTEX® polishing belts p. 197



SC fleece belts p. 195

SuperPolish belt p. 198

BELT SANDERS

Mains powered machines

SUITABLE FOR BELT DIMENSIONS 40 X 780 MM

TOPRAIL 1100 HT Pipe Belt Sander

High-precision tube processing
with the smallest size

Extremely **compact and powerful pipe belt sander** for **easy and fatigue-free sanding, satin finishing or polishing of round pipes**. During use, the machine is resiliently placed on the round tube from above, which enables **fatigue-free work for hours**, as the weight of the machine rests on the work-piece. Thanks to the **high-performance motor with planetary gear**, a **triple torque** is generated compared to grinders of a similar design. The TOPRAIL 1100 HT is therefore **ideally suited for continuous use**, and that with **low weight and very compact dimensions**. All functional parts are made of **high-quality, milled aluminum**, **wear-resistant drive and deflection rollers** (with lateral belt guide). As a result, **high precision** and a perfect end result.

NEW



Belt dimensions: 40 x 780 mm



Pipe diameter
ideal Ø 20 – 80 mm
max. Ø 130 mm

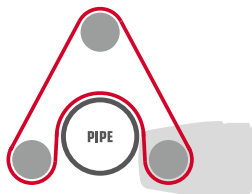

Sophisticated planetary gear for high power reserves and torque

Benefits at a glance

- Particularly easy **belt change in seconds**.
- **Stainless steel** protective covers.
- Ideal for working in **tight grinding areas** – the handle can be adjusted accordingly.
- Extremely compact, powerful and high-torque thanks to the exclusive **planetary gear (high torque) with high pulling power** – up to three times higher than comparable devices.
- Fatigue-free, **easily controllable belt guide**.
- "Marathon-Engine" offers **30% higher power reserves** with up to **50% more torque** compared to comparable devices.
- Motor with **multiple dust protection** for a long service life.
- **Electronic overload protection, soft start and restart protection**.
- **Switch-off carbon brushes** to protect the motor.
- Maintenance-friendly device design – for **carbon brush replacement in seconds**.
- The machine can be put down without touching the table in the standing position.
- **Made in Germany**.



BELT SANDERS

Mains powered machines

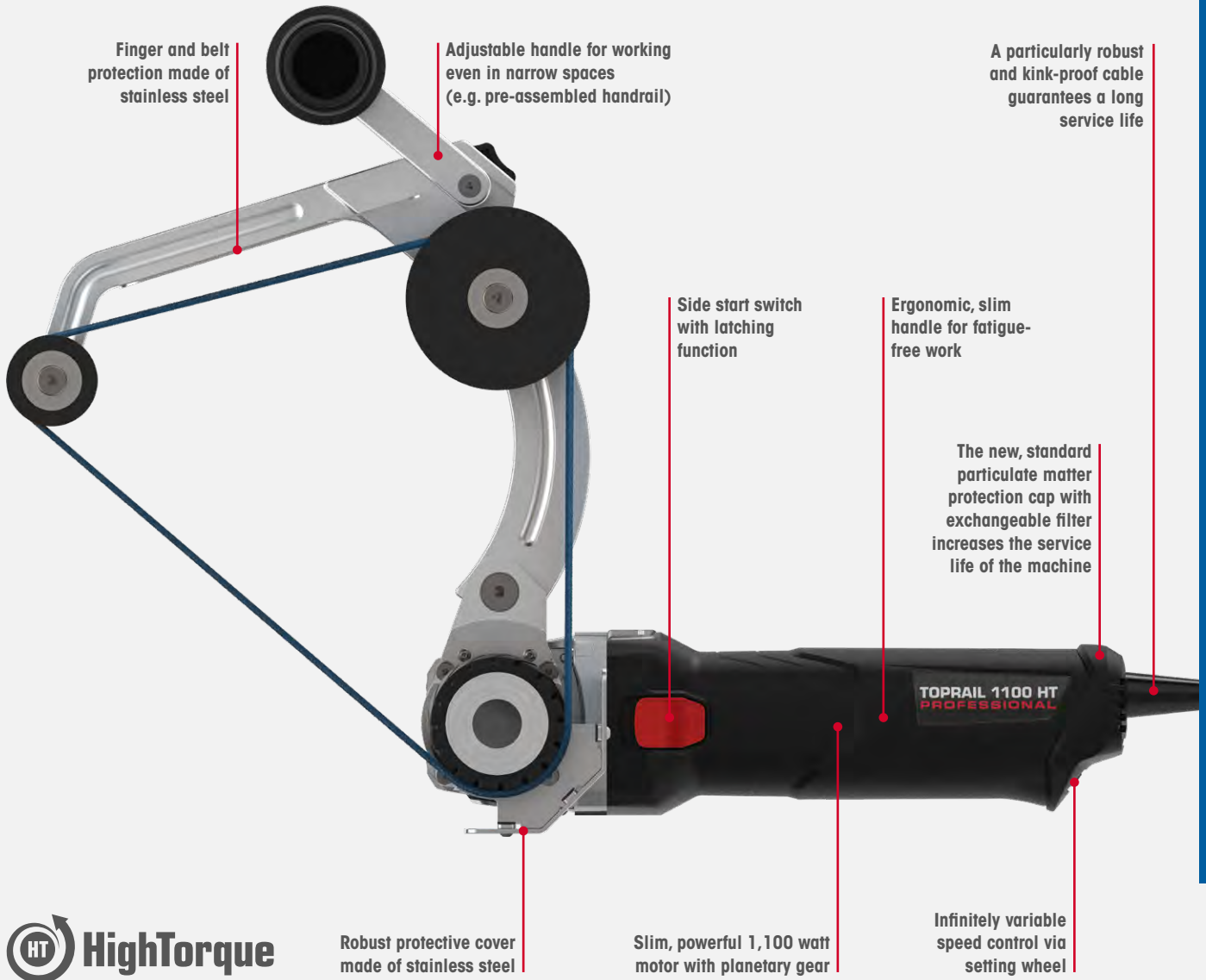

Finger and belt protection made of stainless steel

Adjustable handle for working even in narrow spaces (e.g. pre-assembled handrail)

A particularly robust and kink-proof cable guarantees a long service life

Side start switch with latching function

Ergonomic, slim handle for fatigue-free work

The new, standard particulate matter protection cap with exchangeable filter increases the service life of the machine



Robust protective cover made of stainless steel

Slim, powerful 1,100 watt motor with planetary gear

Infinitely variable speed control via setting wheel

Technical specifications TOPRAIL 1100 HT pipe belt sander

Plug type	Cable type	Mains connection (V ~ Hz)	Power (W)	Belt dimensions (W x L mm)	Speed (rpm)	Belt speed (m/sec)	Weight (kg)	Pkg. unit	Article number
EU (C+F)	Permanent connection	220 – 240 ~ 50 – 60	1,100	40 x 780	800 – 3,000	2.5 – 9.4	3.8	1	38810
GB (G)	Permanent connection	110 – 120 ~ 50 – 60	1,100	40 x 780	800 – 3,000	2.5 – 9.4	3.8	1	38810a

- Contents:**
- 1 TOPRAIL 1100 HT pipe belt sander
 - 1 Robust, impact-resistant plastic case
 - 1 Particulate matter protection cap
 - 3 Zircon belts
 - 1 SC fleece belt

Please note: Practical accessory set see page 190.

The new, standard particulate matter protection cap with exchangeable filter increases the service life of the machine!



With a practical recess for speed control! (see page 232)

You can find suitable belts from page 193.



Zircon belt SC fleece belts SuperPolish belt

The ideal addition to your machine: the pipe processing accessory set (page 190)



BELT SANDERS

Mains powered machines

SUITABLE FOR BELT DIMENSIONS 40 X 780 MM

ROHR MAX® 802 HT

The perfect finish for any pipe-grinding task

Thanks to a newly developed planetary gear, the frictional extension is now distributed over three additional, refined gears. As a result, longevity and pulling force are dramatically increased. Significantly improved air control technology with turbo fan and strongly encapsulated anchors and field windings bring a powerhouse to days, which was not known yet.

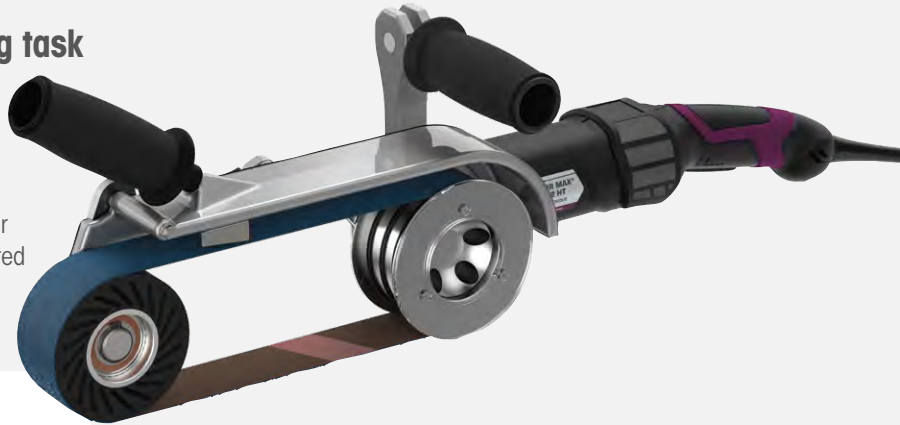

Belt dimensions: 40 x 780 mm

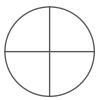

Ø 40 – 130 mm
pipe diameter

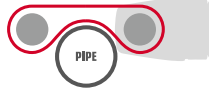

Benefits at a glance

- **Extremely powerful, durable motor (1,750 W)** and new HT (high torque) transmission mechanics for wear-resistant power transmission – 100% made in Germany.
- **Planetary gear provides maximum torque throughout the speed range (820 to 3,000 rpm, belt speed 4 to 13,5 m/sec)** with a tacho-generator for constant speed, even under load.
- Especially robust and kink-proof cable ensures long service life.
- **Homogeneous, uniform grinding and polishing results for all pipe diameters**, large and small.
- **Patented damping concept** allows the grinding and polishing belts to **fit around the pipes to maximum effect with no great effort**.
- **New drive roller** with replaceable rubber O-rings guarantees no-slip belts running.
- The contact wheel made from soft polyurethane material ensures **particularly soft contact and permanent elasticity**. It also allows flat surfaces to be ground longitudinally to remove spot welds and eliminate deep scratches, for instance.
- **Quick, simple belt replacement**.
- **No more adjustments required**. Ideal belt guide thanks to the **lateral stainless steel flanges**.
- **Balanced, multi-adjustable handle** allows optimum adjustment to the job in hand.
- Can be set up **for right and left-handed use** or for side and overhead work.
- The **belt unit of gravity die-cast aluminium** is particularly robust and resistant.
- Especially flexible and easy use.
- Optional available:
ROHR MAX® finger protection cover according to DIN/VDE.



BELT SANDERS

Mains powered machines

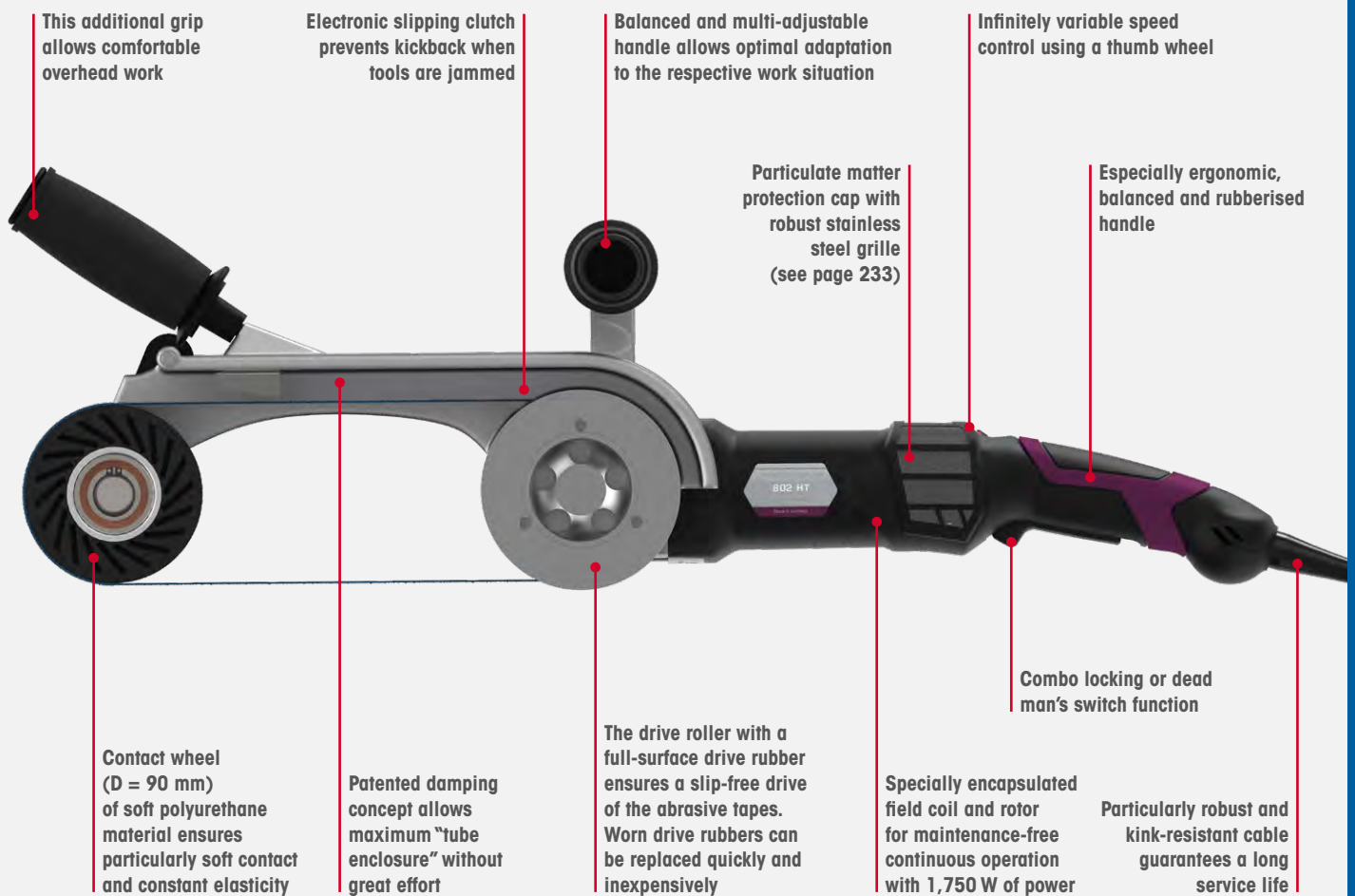

Technical specifications ROHR MAX® 802 HT basic set

Plug type	Cable type	Mains connection (V ~ Hz)	Power (W)	Belt dimensions (W x L mm)	Speed (rpm)	Belt speed (m/sec)	Weight (kg)	Pkg. unit 	Article number
EU (C+F)	Permanent connection	220 – 240 ~ 50 – 60	1,750	40 x 780	820 – 3,000	4.0 – 13.5	4.7	1	38701
GB (G)	Permanent connection	110 – 120 ~ 50 – 60	1,750	40 x 780	820 – 3,000	4.0 – 13.5	4.7	1	38701a

- Contents:**
- 1 ROHR MAX® 802 HT basic device
 - 1 Particulate matter protection cap
 - 3 Zircon belts
 - 1 SC fleece belt

Please note: Practical accessory set see page 190. Delivery in a cardboard box. We therefore recommend the professional transport case (see page 227, item no. 50104) to be ordered as well.



A **high-quality planetary gear** has been designed for grinding machines in the low speed range. It ensures wear-resistant power transmission with enormous additional torque.

NEW: ROHR MAX® finger protection cover according to DIN/VDE (see page 189)

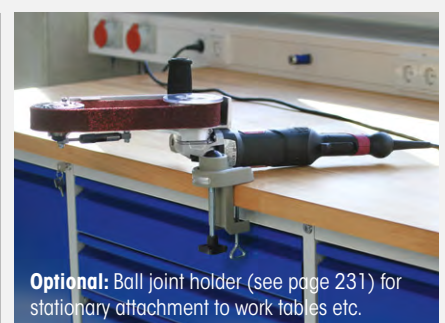
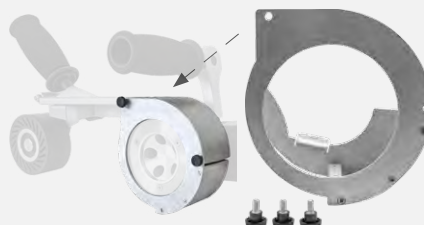

Optional: Ball joint holder (see page 231) for stationary attachment to work tables etc.

BELT SANDERS

CAS cordless machines

SUITABLE FOR BELT DIMENSIONS 30 X 533 MM

ROHR MAX® AKKU

Pipe machining while on the go

The ideal cordless pipe belt grinder with the power of a plug-in machine. Perfect for construction sites, shipyards (for railing work, for example), balustrade and hand-rail production, and much more!



Belt dimensions: 30 x 533 mm

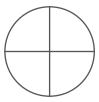

Ø 20 – 80 mm
pipe diameter

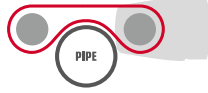

Benefits at a glance

- **Homogeneous, uniform grinding and polishing results for all pipe diameters**, large and small.
- **Planetary gear delivers maximum torque.**
- **Patented damping concept allows** the grinding and polishing belts **to fit around the pipes to maximum effect** with no great effort.
- **New drive roller** with replaceable rubber O-rings guarantees no-slip belts running.
- **Ideal belt guide thanks to the lateral stainless steel flanges.** No more adjustments required.
- **Quick, simple belt replacement.**
- **Available for the first time with planetary gear**, giving it the power of a plug-in machine of ~1,600 watts.
- The contact wheel made from soft polyurethane material ensures **particularly soft contact and permanent elasticity.** It also allows flat surfaces to be ground longitudinally to remove spot welds and eliminate deep scratches, for instance.
- **Balanced and vibration-damping rubber ball handle** reduces strain on the user.
- The **belt unit of gravity die-cast aluminium** is particularly robust and resistant.



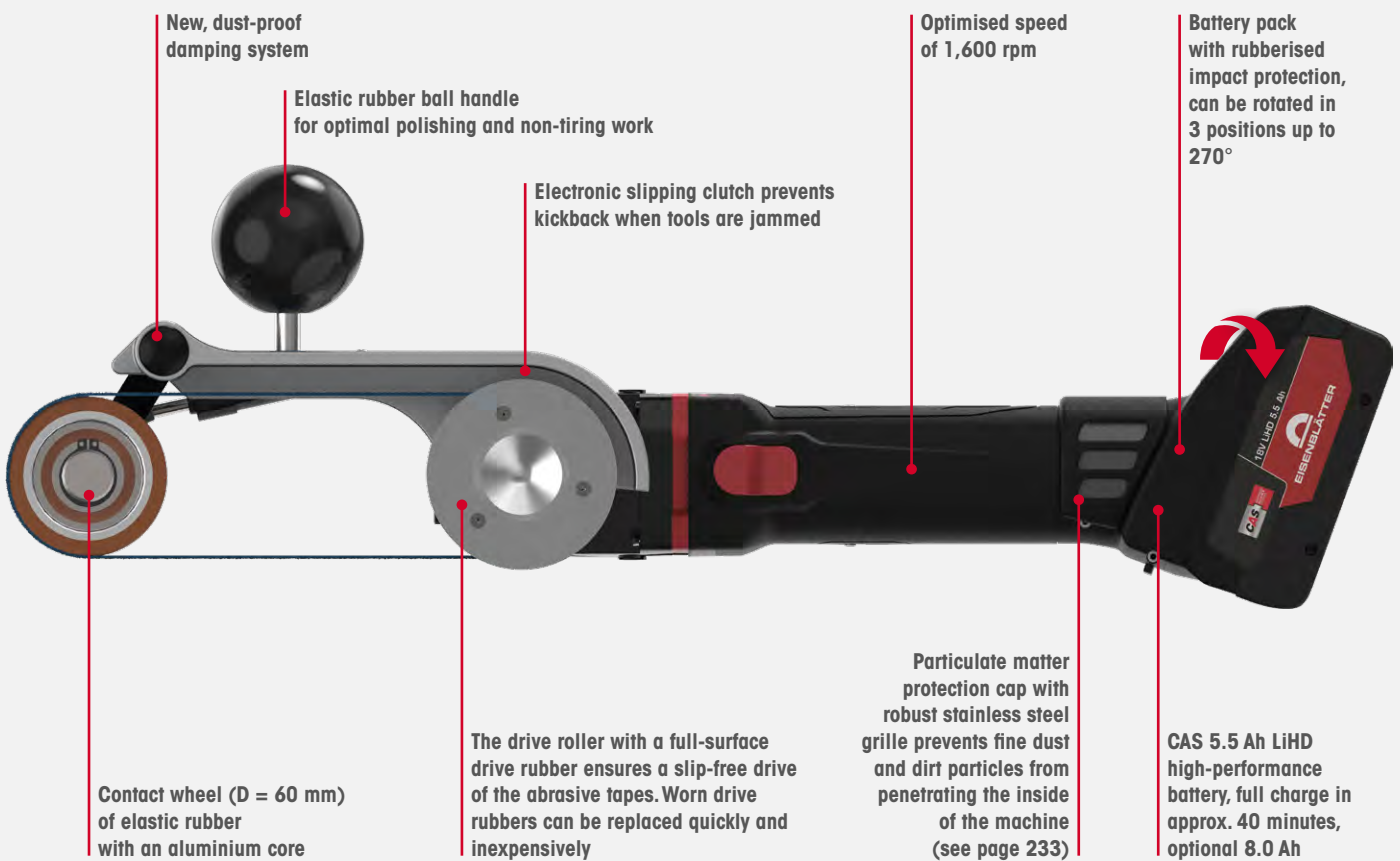

Technical specifications ROHR MAX® AKKU basic set / basic device (without CAS batteries, charger and accessories)

Item	Plug type	Cable type	Mains connection (V ~ Hz)	Power (V)	Belt dimensions (W x L mm)	Speed (rpm)	Belt speed (m/sec)	Weight (kg)	Pkg. unit 	Article number
Basic set	EU (C+F)	Permanent connection	220 – 240 ~ 50 – 60	18	30 x 533	1,600	5.3	3.24	1	38041
Basic device	EU (C+F)	Permanent connection	220 – 240 ~ 50 – 60	18	30 x 533	1,600	5.3	3.24	1	38042

Scope of delivery ROHR MAX® AKKU basic set:

- 1 ROHR MAX® AKKU basic device
- 1 Robust, impact-resistant plastic case
- 1 Particulate matter protection cap
- 2 LiHD batteries 18 volts with 5.5 Ah capacity (CAS)
- 1 Fast charger incl. cable (CAS)
- 3 Zircon belts 30 x 533 mm
- 3 Replacement rubber O-rings



Please note: Practical accessory set see page 191, batteries and chargers see page 229.

Scope of delivery ROHR MAX® AKKU basic device:

- 1 ROHR MAX® AKKU basic device
- 1 Robust, impact-resistant plastic case



Attention: No battery and no charger included!



A **high-quality planetary gear** has been designed for grinding machines in the low speed range. It ensures wear-resistant power transmission with enormous additional torque.

The ideal addition to your machine:
ROHR MAX® AKKU accessory set (see page 191)



You can find suitable belts from page 193.



Zircon belt SC fleece belts SuperPolish belt

BELT SANDERS

Mains powered machines

SUITABLE FOR BELT DIMENSIONS 40 X 780 MM

ROHR SNIPER® 802 HT

360° pipe machining from a single position

Robust, balanced hand-held machine for quick pipe machining with a high-quality, milled lever system that immediately encloses 2/3 of the diameter of the pipe to be machined! This means that, for the first time, the entire pipe diameter can be ground and polished from a single working position! Very precise, stable mechanism of high-quality milled aluminium.



Belt dimensions: 40 x 780 mm

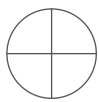

Ø 25 – 70 mm
pipe diameter

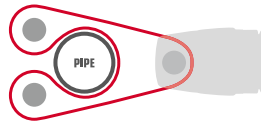

Benefits at a glance

- **Minimal force required due to the revolutionary, sophisticated enclosure system.**
- The true 2/3 enclosure (for diameters of 30 to 42 mm) **allows machining pipes through 360 degrees** from a single position. The arms are closed by pulling a lever.
- **Ideal for pipe diameters of 25-70 mm.**
- Innovative technology: **Damping system** reduces force required and **allows pipe to be gently enclosed.**
- The balanced shaft handle with non-slip rubber inserts allows the tool **to be operated easily in any conceivable position.**
- **Extremely powerful, durable motor (1,750 W) and new HT (high torque) transmission mechanics** for wear-resistant power transmission – made entirely in Germany.
- **Planetary gear provides maximum torque throughout the speed range (820 to 3,000 rpm, belt speed 2.5 to 9.2 m/sec)** with a tacho-generator for constant speed, even under load.
- New, optimised milled aluminium building components for **reduced weight.**
- **Robust lever mechanism** of high-quality milled materials for professional use and especially long service life (patented).



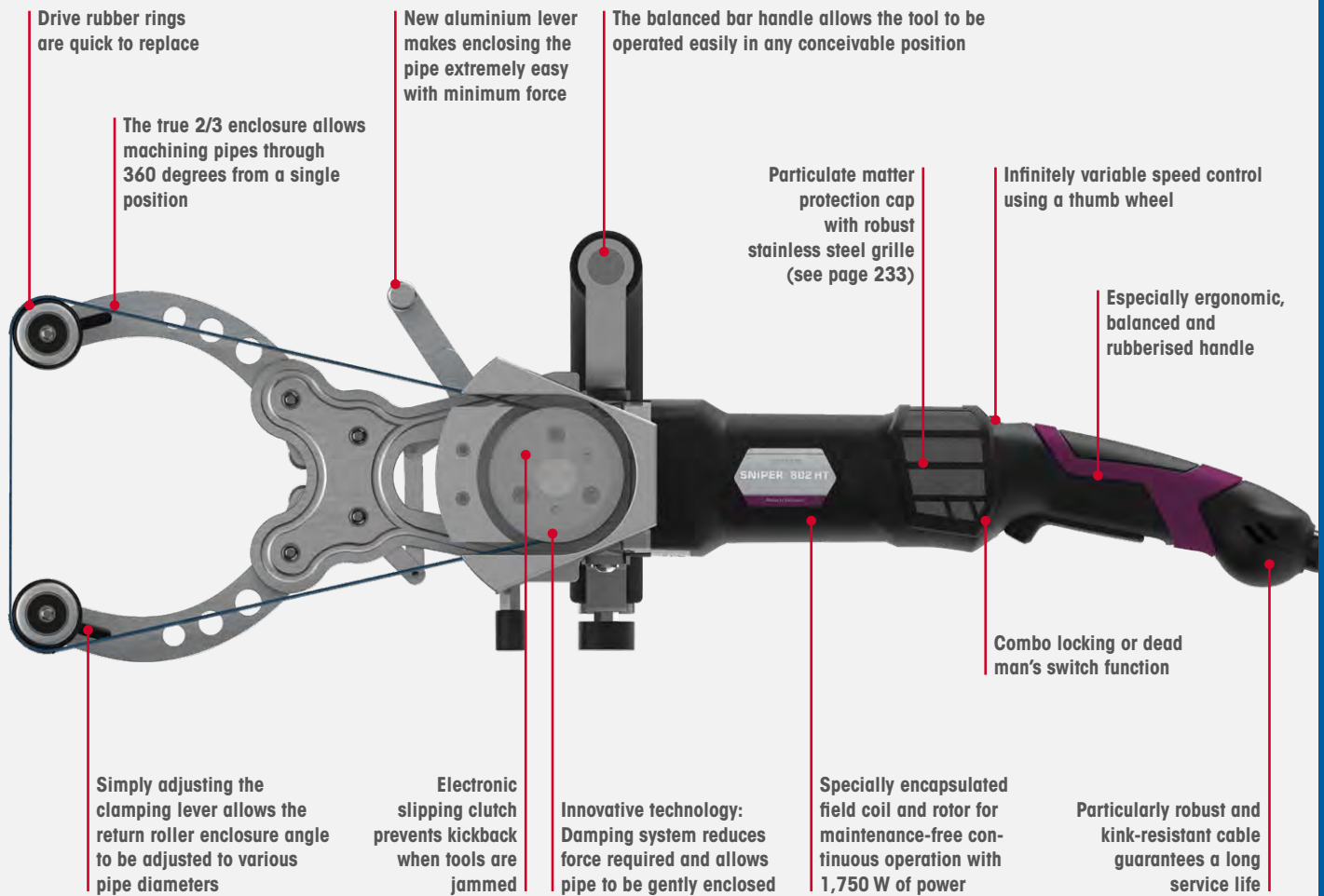

Technical specifications ROHR SNIPER® 802 HT basic set

Plug type	Cable type	Mains connection (V ~ Hz)	Power (W)	Belt dimensions (W x L mm)	Speed (rpm)	Belt speed (m/sec)	Weight (kg)	Pkg. unit 	Article number
EU (C+F)	Permanent connection	220 – 240 ~ 50 – 60	1,750	40 x 780	820 – 3,000	2.5 – 9.2	5.3	1	38801
GB (G)	Permanent connection	110 – 120 ~ 50 – 60	1,750	40 x 780	820 – 3,000	2.5 – 9.2	5.3	1	38801a

- Contents:**
- 1 ROHR SNIPER® 802 HT basic device
 - 1 Particulate matter protection cap
 - 3 Zircon belts
 - 1 SC fleece belt
 - 10 Replacement drive rubber rings

Please note: Practical accessory set see page 190. Delivery in a cardboard box. We therefore recommend the professional transport case (see page 227, item no. 50104) to be ordered as well.



The ideal addition to your machine: Pipe machining accessory set (see page 190)



1,750-watt high-performance motor
A refined motor with very high power density and a number of new features ensures completely new standards of torque, productivity, and service life.



A **high-quality planetary gear** has been designed for grinding machines in the low speed range. It ensures wear-resistant power transmission with enormous additional torque.

BELT SANDERS

Mains powered machines

SUITABLE FOR BELT DIMENSIONS 5 / 9 X 533 MM

BAND-IT 1100 Power File

Finishing with precision

The new **BAND-IT 1100 power file** has an even **more robust drive for continuous professional use**. The mechanics have been improved again and are particularly **powerful and precise**.



Belt dimensions: 5 / 9 x 533 mm



all sizes,
flat surfaces



Benefits at a glance

- Due to the **compact, narrow design**, ideal for **working in "tight spaces"** e.g. possible in edges, folds and corners. Particularly interesting in **railing, apparatus, tool and metal construction**.
- **For sanding and polishing belts 5 and 9 mm wide**. Belt change in seconds. Quickly exchangeable, **brass pulleys**, with high-quality needle bearings and rubberised running surfaces.
- **Grinding and polishing belts** are **automatically guided and adjusted**. The **pre-tensioning can also be locked in place** using a knurled screw, for firmer **contact pressure and precise work**.
- Balanced, powerful machine, **1100 watts**, speed-controlled **2,800 – 9,600 rpm**. Damping by a **dust-protected special spring**. **Mobile or stationary use**, e.g. with **table ball joint holder**.
- **Made in Germany**.



BELT SANDERS

Mains powered machines

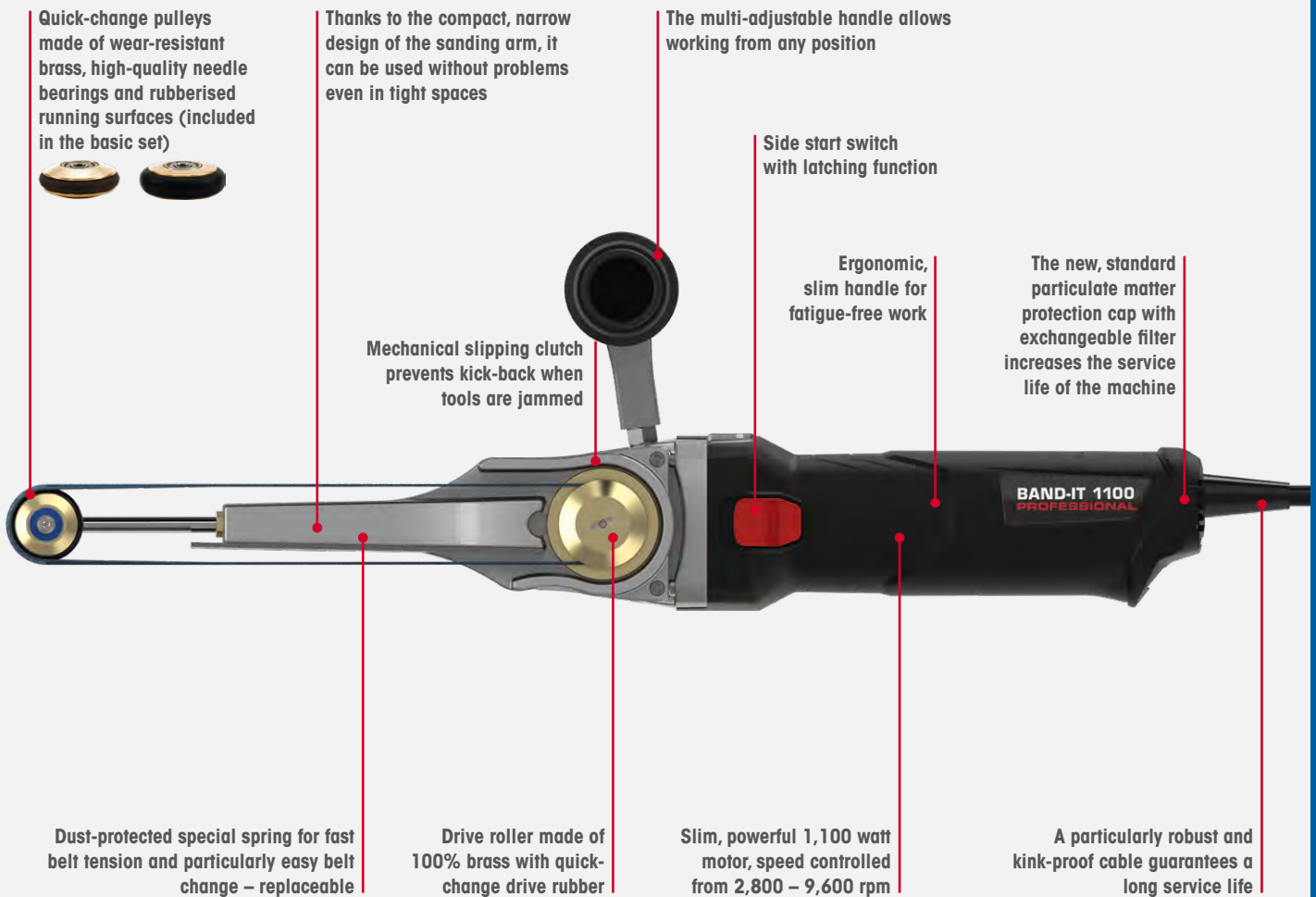

Technical specifications **BAND-IT 1100 power file**

Plug type	Cable type	Mains connection (V ~ Hz)	Power (W)	Belt dimensions (W x L mm)	Speed (rpm)	Belt speed (m/sec)	Weight (kg)	Pkg. unit 	Article number
EU (C+F)	Permanent connection	220 – 240 ~ 50 – 60	1,100	5/9 x 533	2,800 – 9,600	4.0 – 14.0	2.3	1	38071

- Contents:**
- 1 BAND-IT 1100 power file
 - 1 Robust, impact-resistant plastic case
 - 1 Particulate matter protection cap
 - 1 Quick-change pulley for 9 x 533 mm fleece and polishing belts
 - 1 Quick-change pulley for 5 x 533 mm grinding belts
 - 8 Grinding belts 9 x 533 mm

Please note: Practical accessory set see page 192.

The new, standard particulate matter protection cap with exchangeable filter increases the service life of the machine!



With a practical recess for speed control!
(see page 232)

The ideal addition to your machine:
BAND-IT accessory set (see page 192)



Dust-protected special spring for fast belt tension and particularly easy belt change – replaceable

BELT SANDERS

CAS cordless machines

SUITABLE FOR BELT DIMENSIONS 5 / 9 X 533 MM

BAND-IT AKKU

Finishing with cordless freedom

The newly developed, especially compact, powerful, high-quality flat filing machine equipped with a new damping system – with all the properties and power of plug-in machines. The sturdy LiHD battery-powered motor makes it possible.



Belt dimensions: 5 / 9 x 533 mm



All sizes,
flat surfaces



Benefits at a glance

- The **slim, compact design** is ideal for work even in tight spots – edges, grooves, corners, etc. Especially interesting for work in building railings, equipment, and tools and in metal construction generally.
- For grinding and polishing belts between 5 and 9 mm width. Belt replacement in seconds. Quick-change **brass contact wheel** with high-quality needle bearings, and rubberised running surfaces.
- Grinding and polishing belts are **automatically** guided and adjusted. A knurled screw allows pretension to be locked firmly for greater contact pressure and extremely precise work.
- **High-performance battery-powered motor with 18-volt LiHD technology**, as powerful as plug-in devices, **5.5 Ah of battery power (two batteries in the basic set)**. Option of adding 8.0 Ah batteries or a high-speed charger.
- **Damping by dust-proof special spring.**
- **Can be used mobile or stationary**, e.g. by **table ball joint holder.**
- **100% made in Germany.**



BELT SANDERS

CAS cordless machines

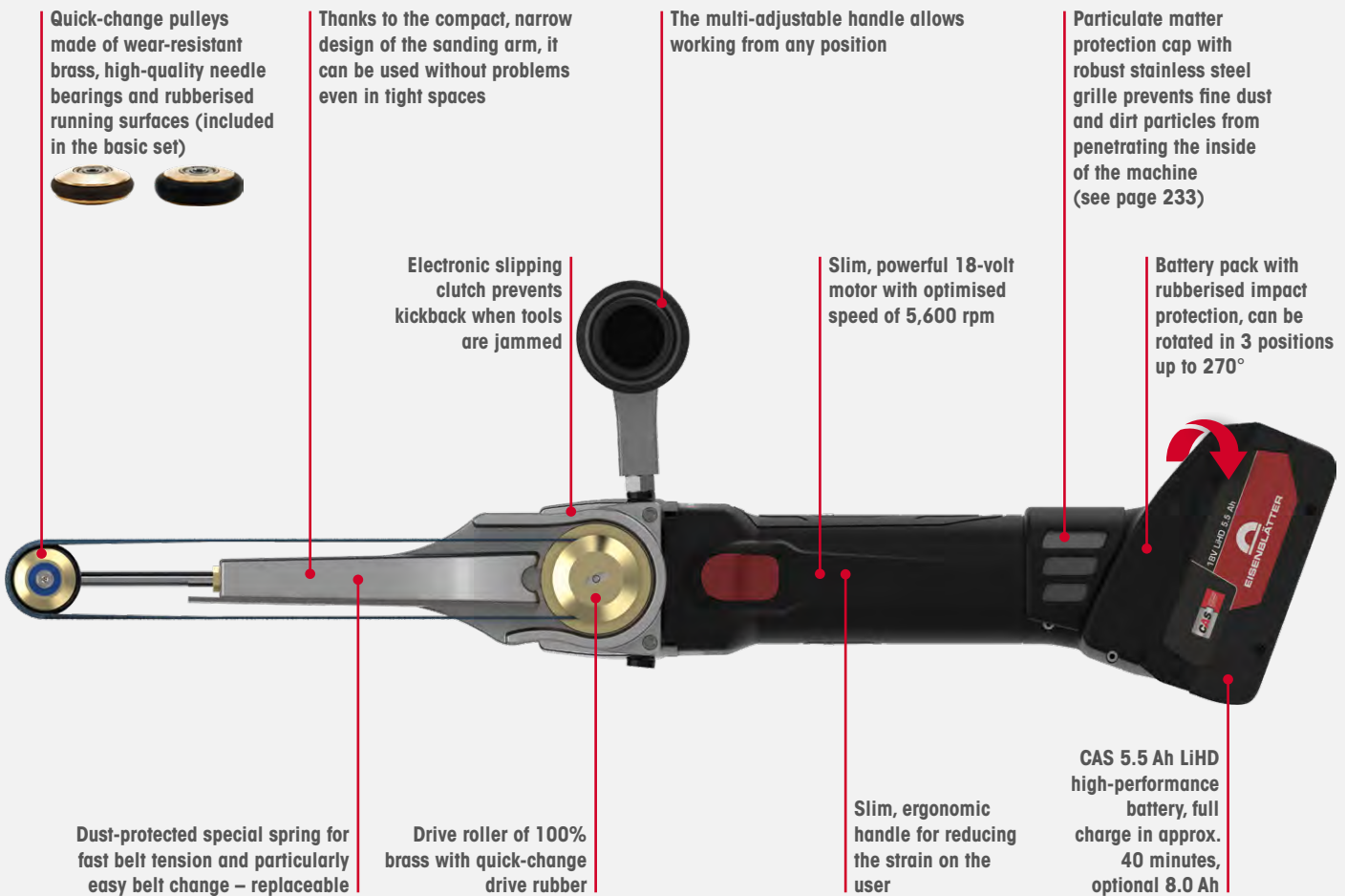

Quick-change pulleys made of wear-resistant brass, high-quality needle bearings and rubberised running surfaces (included in the basic set)



Thanks to the compact, narrow design of the sanding arm, it can be used without problems even in tight spaces

The multi-adjustable handle allows working from any position

Particulate matter protection cap with robust stainless steel grille prevents fine dust and dirt particles from penetrating the inside of the machine (see page 233)

Electronic slipping clutch prevents kickback when tools are jammed

Slim, powerful 18-volt motor with optimised speed of 5,600 rpm

Battery pack with rubberised impact protection, can be rotated in 3 positions up to 270°

Dust-protected special spring for fast belt tension and particularly easy belt change – replaceable

Drive roller of 100% brass with quick-change drive rubber

Slim, ergonomic handle for reducing the strain on the user

CAS 5.5 Ah LiHD high-performance battery, full charge in approx. 40 minutes, optional 8.0 Ah

Technical specifications **BAND-IT AKKU basic set / basic device (without CAS batteries, charger and accessories)**

Item	Plug type	Cable type	Mains connection (V ~ Hz)	Power (V)	Belt dimensions (W x L mm)	Speed (rpm)	Belt speed (m/sec)	Weight (kg)	Pkg. unit	Article number
Basic set	EU (C+F)	Permanent connection	220 – 240 ~ 50 – 60	18	5/9 x 533	5,600	8.75	2.2	1	38101
Basic device	EU (C+F)	Permanent connection	220 – 240 ~ 50 – 60	18	5/9 x 533	5,600	8.75	2.2	1	38102

Scope of delivery **BAND-IT AKKU basic set:**

- 1 BAND-IT AKKU basic device
- 1 Robust, impact-resistant plastic case
- 1 Particulate matter protection cap
- 2 LiHD batteries 18 volts with 5.5 Ah capacity (CAS)
- 1 Fast charger incl. cable (CAS)
- 1 Quick-change pulley for 9 x 533 mm fleece and polishing belts
- 1 Quick-change pulley for 5 x 533 mm grinding belts
- 8 Grinding belts 9 x 533 mm



Please note: Practical accessory set see page 192, batteries and chargers see page 229.

Scope of delivery **BAND-IT AKKU basic device:**

- 1 BAND-IT AKKU basic device
- 1 Robust, impact-resistant plastic case



Attention: No battery and no charger included!

One battery, many solutions. Cross-brand. 100% Compatibility.



BELT GRINDING

BELT SANDERS

Mains powered machines

SUITABLE FOR BELT DIMENSIONS 40 X 780 MM

GLADIUS® 1802 HT

The multi-purpose grinding sword

Now you can grind, smooth, de-burr, polish, and remove rust and scales quickly with the new, easy-to-use "grinding sword". Extra-long work area allows machining on one or both sides, even for difficult-to-reach work-pieces. Belt replacement is very simple, meaning that almost any metal, from stainless steel to non-ferrous metals and other materials, from plastic to stone to wood, can be machined quickly. The GLADIUS® is ideally balanced and can do the work of many common stationary grinding machines without any trouble. Its versatility makes it usable in a workshop or very tight spaces.



Sophisticated planetary gear for high power reserves and torque

Belt dimensions: 40 x 780 mm



All sizes, flat surfaces



Benefits at a glance

- **For mobile and stationary use:** extremely versatile, can be used for nearly any flat grinding and polishing work with the entire belt arm surface.
- **Optional angle attachment** for grinding work at a fixed angle, replaceable for the belt direction and the opposite direction, for such tasks as sharpening blades and tools.
- Optional table ball joint mount allows stationary use at any angle or position.
- Belt guide extension arm consists of a new, **specialty developed alloy for greatly reduced grinding temperatures.**
- Very easy **belt replacement takes only seconds;** the drive roller has low-cost, replaceable rubber rings and lateral stainless steel guides.
- **The drive motor's revolutionary planetary gear makes it durable with great pulling power** at 1,750 watts and 820 to 3,000 rpm (belt speed: 2.5 to 9.2 m/sec).
- It has a tachogenerator for constant speed, even under load.

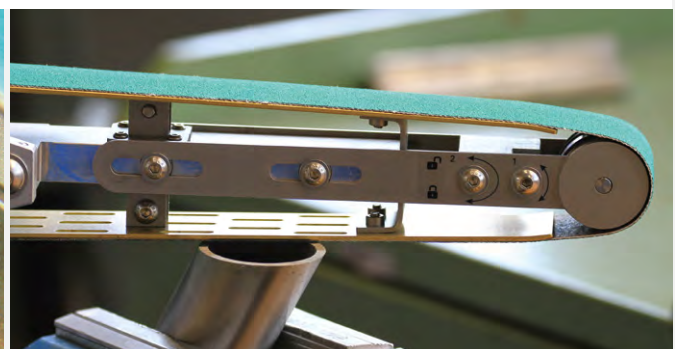
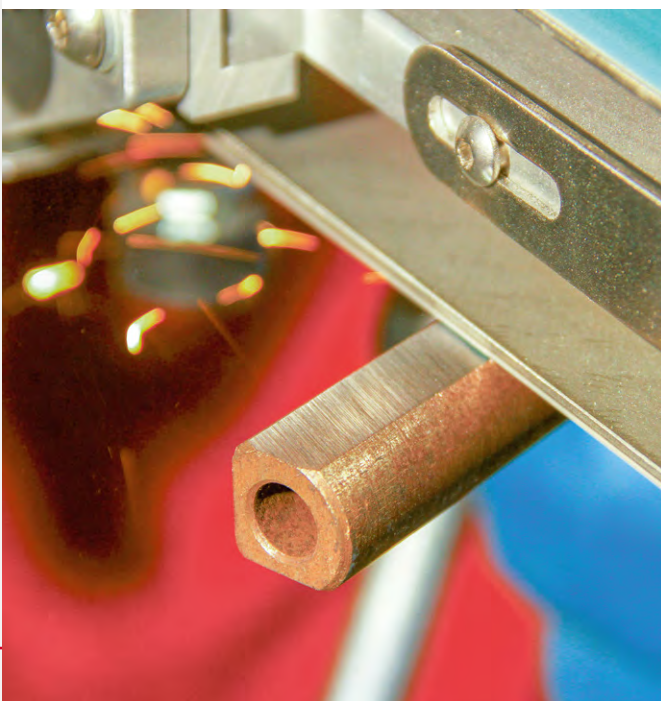

BELT SANDERS

Mains powered machines

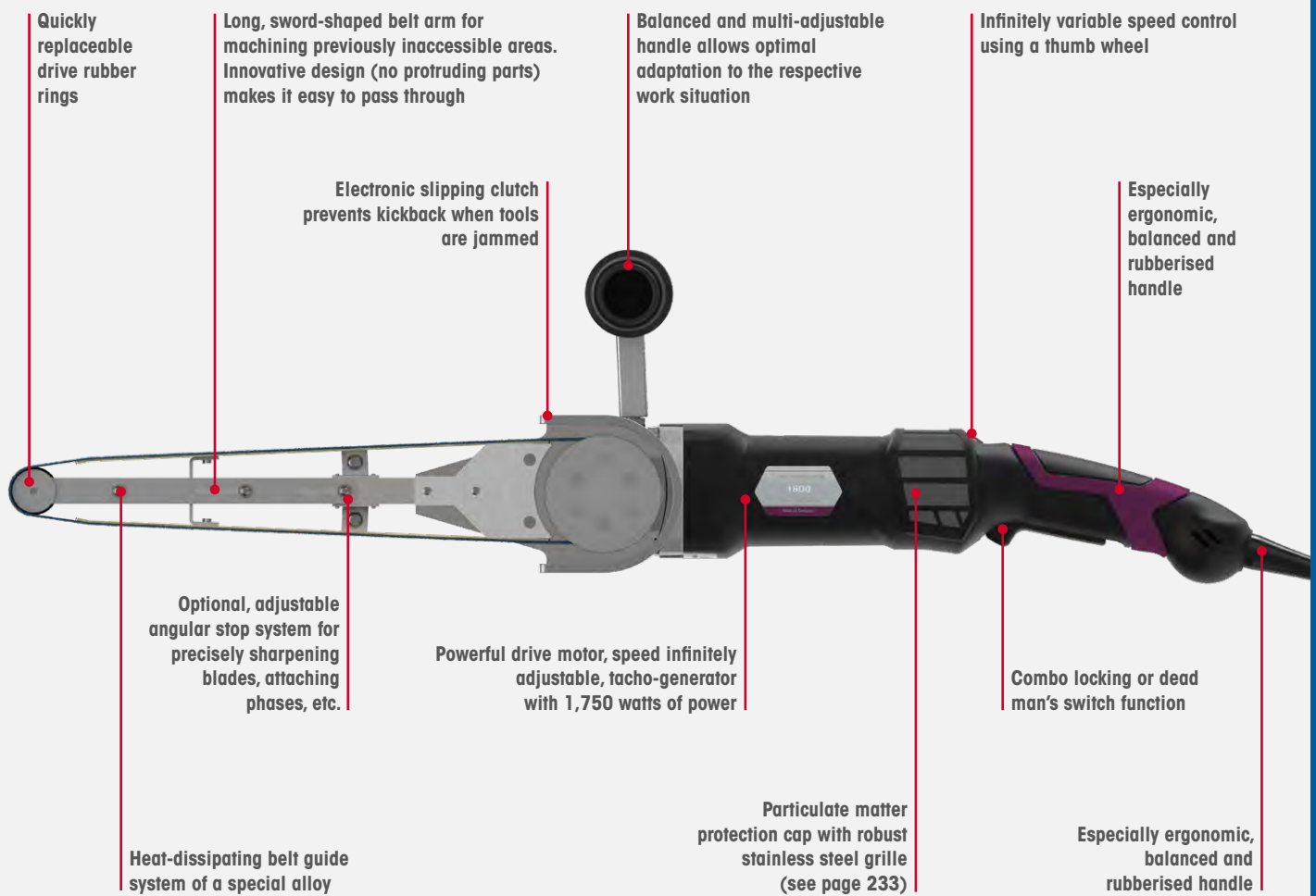

Technical specifications **GLADIUS® 1802 HT basic set**

Plug type	Cable type	Mains connection (V - Hz)	Power (W)	Belt dimensions (W x L mm)	Speed (rpm)	Belt speed (m/sec)	Weight (kg)	Pkg. unit 	Article number
EU (C+F)	Permanent connection	220 – 240 ~ 50 – 60	1,750	40 x 780	820 – 3,000	2.5 – 9.2	4.6	1	38901
GB (G)	Permanent connection	110 – 120 ~ 50 – 60	1,750	40 x 780	820 – 3,000	2.5 – 9.2	4.6	1	38901a

- Contents:**
- 1 GLADIUS® 1802 HT basic device
 - 1 Particulate matter protection cap
 - 1 Allen key 5 mm
 - 1 Allen key 3 mm
 - 1 Chuck key
 - 4 Zircon belts 40 x 780 mm
 - 5 Replacement drive rubber rings

Please note: Practical accessory set see page 190. Delivery in a cardboard box. We therefore recommend the professional transport case (see page 227, item no. 50104) to be ordered as well.

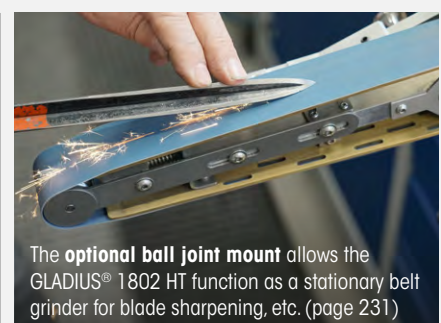

SUITABLE FOR GLADIUS®

Interchangeable Angular Stop with Belt Cover

For high-precision work such as tool grinding from a wide range of angles and radii, sharpening and polishing of metals of any kind, right up to precise knife grinding

The interchangeable, robust angular stop with belt cover immediately allows precise, stationary work such as sharpening tools (knives, trowels, chocks, and much more). Either belt direction, and a precise angle, can be selected. The optional ball joint table mount transforms the GLADIUS® into a perfect mini-workshop for anyone.

The associated stable belt protection eliminates any risk of injury due to inadvertent contact with moving belts. The selection of a wide variety of grinding and polishing belts allows quick, precise coarse, fine grinding as well as polishing.

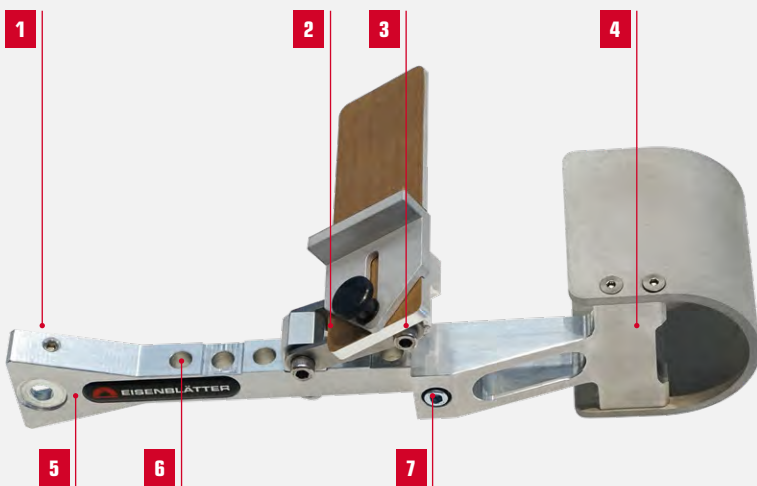

- 1 Mounting bolt for a secure connection
- 2 Laterally adjustable longitudinal angular hand guide (45-90°)
- 3 Infinitely adjustable angular support table (15-90°) (in the belt's running direction and the opposite direction)
- 4 Stable aluminium protective cover with an extension arm
- 5 Sturdy attachment arm milled from solid aluminium with surface protection
- 6 Six positioning holes for flexible placement of the angular support table
- 7 Docking station for connecting the protective cover
- 8 Including angle gauge for precise angle setting

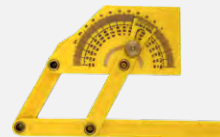

Technical specifications

Can be used with	Adjustable angular stop of	Pkg. unit 	Article number
GLADIUS® 1802 HT, GLADIUS® 1800	15 – 90°	1	38902

Allows high-precision work such as tool grinding from a wide range of angles and of a wide range of radii, sharpening and polishing of metals of any kind, right up to precise knife grinding



SUITABLE FOR ROHR MAX® 802 HT

ROHR MAX® Finger Protection Cover

according to DIN / VDE

For **additional protection** against possible "finger injuries" on the belt drive roller, this robust "aluminum housing" was developed **in accordance with DIN / VDE** for the belt deflection.

This **effectively prevents a finger from being drawn into the drive.**

It is **attached easily** and **without tools using knurled screws.**

The finger guard also **enables the machine to be placed upright** on the work table without the belt touching it.



Technical specifications

Item	Can be used with	Pkg. unit 	Article number
Finger protection cover incl. 3 knurled screws	ROHR MAX® 802 HT (from date of purchase 06/2021)	1	38703

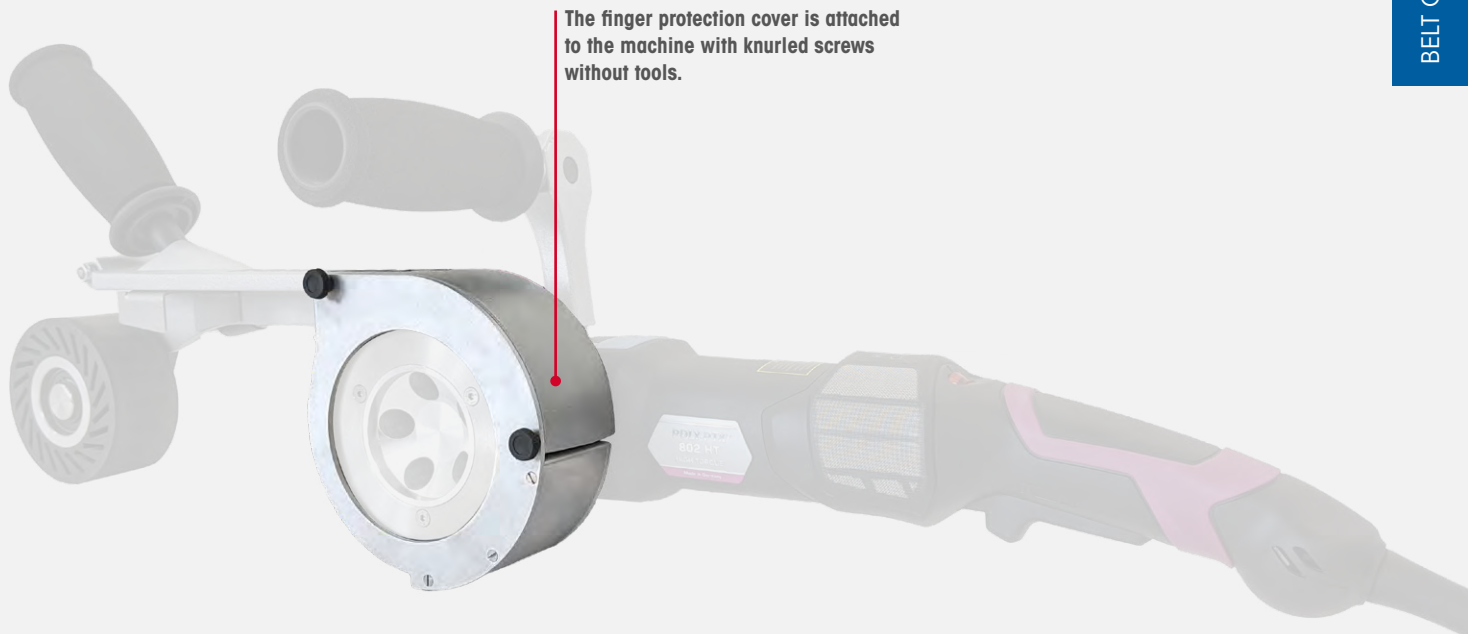

The finger protection cover is attached to the machine with knurled screws without tools.

BELT SANDERS

Accessory sets

SUITABLE FOR ROHR MAX® · GLADIUS® · ROHR SNIPER® · TOPRAIL 1100 HT

Pipe Machining Accessory Set

Belt dimensions 40 x 780 mm



The pipe machining accessory set means that the right tools are always handy. The ideal addition to your machine. Suitable for many tasks ranging from coarse and fine grinding (industrial finish) to perfect mirror finishing – all safely stowed in the stable carrying case.

Technical specifications

Application	Can be used with	Pkg. unit 	Article number
Coarse and fine grinding to a mirror finish	ROHR MAX®, GLADIUS®, ROHR SNIPER®, TOPRAIL 1100 HT	1	38702

Contents:

- | | |
|-------------------------|--|
| 1 Mobile tool case | 1 BRIGHTEX® Softclean Powder |
| 8 Zircon belts | 1 BRIGHTEX® Berry mini pre-polishing paste |
| 6 SC fleece belts | 1 BRIGHTEX® Sun mini post-polishing past |
| 6 Trizact™ belts | 2 BRIGHTEX® microfibre cloths |
| 2 BRIGHTEX® Berry belts | 1 BRILLIANCE CLEAN 50 ml |
| 2 BRIGHTEX® Sun belts | 1 POWER CLEANER 50 ml |
| | 1 INOX PROTECT 50 ml |



The ideal supplement for these belt sanders:

NEW



TOPRAIL 1100 HT

p. 174



ROHR MAX® 802 HT

p. 176



ROHR SNIPER® 802 HT

p. 180



GLADIUS® 1802 HT

p. 186

SUITABLE FOR ROHR MAX® AKKU

ROHR MAX® AKKU Accessory Set

Belt dimensions 30 x 533 mm



The ideal addition to your machine. Suitable for many tasks ranging from coarse and fine grinding (industrial finish) to perfect mirror finishing – all safely stowed in the stable carrying case.

Technical specifications

Application	Can be used with	Pkg. unit 	Article number
Coarse and fine grinding to a mirror finish	ROHR MAX® AKKU	1	38032

Contents:

- | | |
|-------------------------------|--|
| 1 Mobile tool case | 1 BRIGHTEX® Softclean Powder |
| 8 Zircon belts | 1 BRIGHTEX® Berry mini pre-polishing paste |
| 6 SC fleece belts | 1 BRIGHTEX® Sun mini post-polishing paste |
| 6 Trizact™ belts | 1 BRILLIANCE CLEAN 50 ml |
| 4 BRIGHTEX® Berry belts | 1 POWER CLEANER 50 ml |
| 4 BRIGHTEX® Sun belts | 1 INOX PROTECT 50 ml |
| 2 BRIGHTEX® microfibre cloths | |



The ideal supplement for these ROHR MAX® belt sanders:



ROHR MAX® AKKU

p. 178

BELT SANDERS

Accessory sets

SUITABLE FOR BAND-IT 1100 - BAND-IT AKKU



BAND-IT Accessory Sets

Belt dimensions 5 / 9 x 533 mm



The BAND-IT accessory set accessory set means that the right tools are always handy. The ideal addition to your machine. Suitable for many tasks ranging from coarse and fine grinding (industrial finish) to perfect mirror finishing – all safely stowed in the stable carrying case.

Technical specifications

Application	Can be used with	Pkg. unit 	Article number
Coarse and fine grinding to a mirror finish	BAND-IT 1100, BAND-IT AKKU	1	38062
Contents: 1 Mobile tool case 40 Narrow high-quality corundum belts 9 x 533 mm 20 Narrow high-quality corundum belts 5 x 533 mm 6 Narrow SC fleece belts 9 x 533 mm 6 Narrow Trizact™ belts 9 x 533 mm 6 Narrow felt belts 9 x 533 mm 2 BRIGHTEX® microfibre cloths 1 BRIGHTEX® Softclean Powder 1 BRIGHTEX® Berry mini pre-polishing paste 1 BRIGHTEX® Sun mini post-polishing paste 1 BRILLIANCE CLEAN 50 ml 1 POWER CLEANER 50 ml 1 INOX PROTECT 50 ml			

The ideal supplement for these BAND-IT power files:

NEW



BAND-IT 1100

p. 182



BAND-IT AKKU

p. 184

BELT GRINDING

SUITABLE FOR STEEL · STAINLESS STEEL

Zircon Belt

High-quality, flexible zirconium grinding belt with cooling agents for removing material from weld seams; eliminating deep scratches, rust, and scale; and performing coarse industrial finishing work. Prevents discoloration.



Technical specifications **Zircon belt suitable for ROHR MAX®, ROHR SNIPER®, GLADIUS® and TOPRAIL 1100 HT**

Dimensions (mm)	Material	Pkg. unit 	Grit (K)	Article number
40 x 780	Zirconium cloth with highly active cooling agents	10	40	38524
			60	38526
			80	38528
			120	38529

Technical specifications **Zircon belt suitable for ROHR MAX® AKKU**

Dimensions (mm)	Material	Pkg. unit 	Grit (K)	Article number
30 x 533	Zirconium cloth with highly active cooling agents	10	40	38074
			60	38076
			80	38078
			120	38079



GRINDING BELTS

Grinding and blending

SUITABLE FOR ALL METALS

High-quality Corundum Grinding Belt

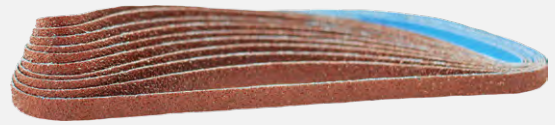

Elastically flexed high-quality corundum grinding belt for a variety of grinding work, such as coarse grinding, pre-grinding, smoothing, and removal of scale and rust, even on tight radii.

Technical specifications **High-quality corundum grinding belt suitable for BAND-IT 1100 and BAND-IT AKKU**

Dimensions (mm)	Material	Pkg. unit 	Grit (K)	Article number
9 x 533	High-quality corundum	10	40	49024
			60	49026
			80	49028
			120	49029
5 x 533	High-quality corundum	10	40	49504
			60	49506
			80	49508
			120	49509



SUITABLE FOR STEEL · STAINLESS STEEL · NON-FERROUS METALS · WOOD · HARD PLASTICS

SC Fleece Belts

Technical surface conditioning fleece belt for grinding, matt finishing, **satin finishing**, deburring, and **removing minor scratches** and oxide layers **on pipe constructions** and railings.

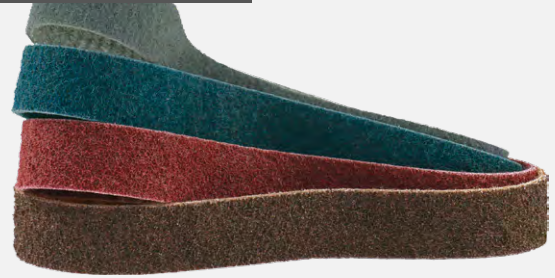

Technical specifications SC fleece belt suitable for ROHR MAX®, ROHR SNIPER®, GLADIUS® and TOPRAIL 1100 HT

Dimensions (mm)	Material	Pkg. unit 	Grit (K)	Colour (fleece)	Grit (fleece)	Article number
40 x 780	SC nylon fleece with reinforcing fabric	4	80	brown	coarse	38531
			180	red	medium	38532
			280	blue	fine	38533
			400	grey	very fine	38534

Technical specifications SC fleece belt suitable for ROHR MAX® AKKU

Dimensions (mm)	Material	Pkg. unit 	Grit (K)	Colour (fleece)	Grit (fleece)	Article number
30 x 533	SC nylon fleece with reinforcing fabric	4	80	brown	coarse	38081
			180	red	medium	38082
			280	blue	fine	38083

Technical specifications SC fleece belt suitable for BAND-IT and BAND-IT AKKU

Dimensions (mm)	Material	Pkg. unit 	Grit (K)	Colour (fleece)	Grit (fleece)	Article number
9 x 533	SC nylon fleece with reinforcing fabric	10	180	red	medium	49011s
			280	blue	fine	49012s

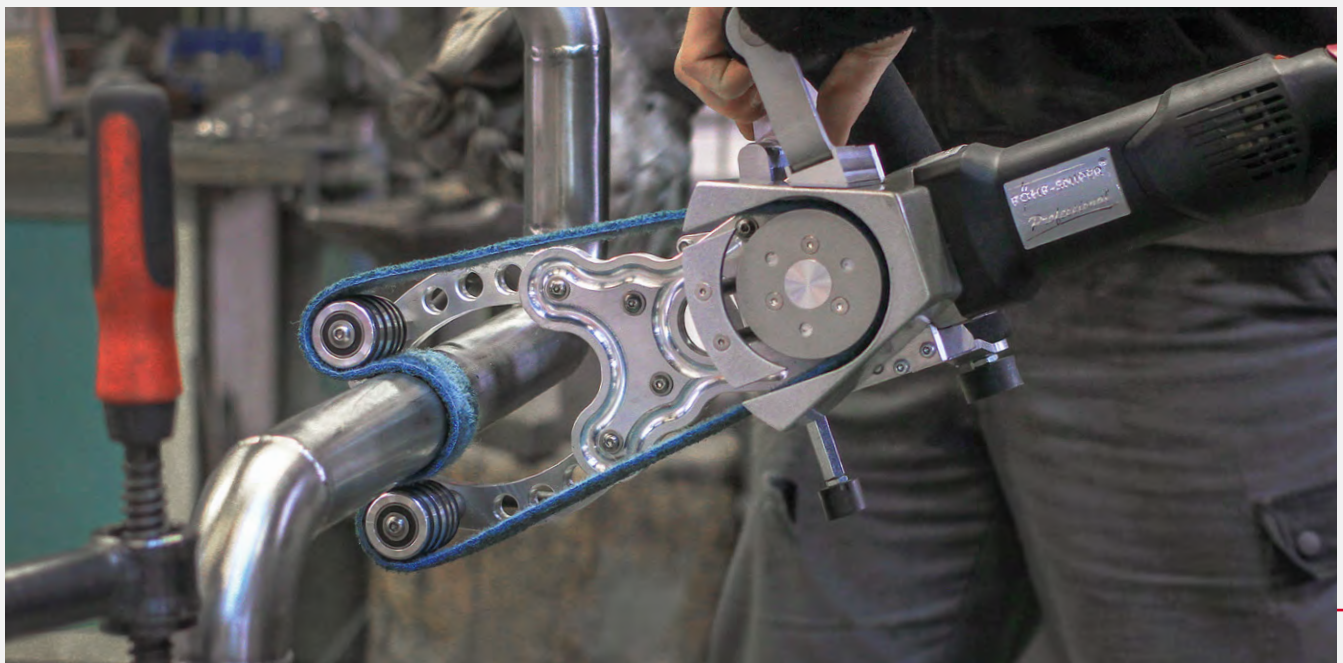

GRINDING BELTS

Finishing and fine grinding

SUITABLE FOR STEEL · STAINLESS STEEL

Trizact™ Belt

Ideal for removing scratches and pre-polishing for mirror-finish polishing

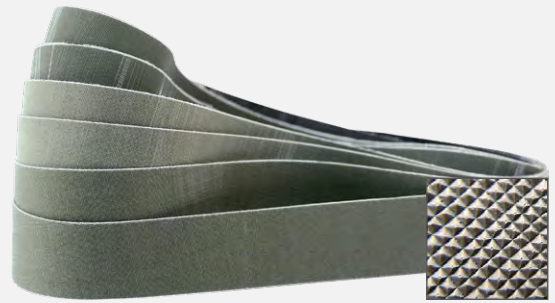

New type of **abrasive cloth** with **pyramid-shaped grit structure** and **additional heat-insulating layer**. Saves on several operating **steps** and has high material removal with **very fine results** while removing scratches and spot welds. Ideal pre-polishing for subsequent mirror-finish polishing. Leaves very **minor surface roughness**.

Technical specifications Trizact™ belt suitable for ROHR MAX®, ROHR SNIPER®, GLADIUS® and TOPRAIL 1100 HT

Dimensions (mm)	Pkg. unit 	Grit (Trizact™)	Grit (K)	Material removal (like approx. K)	Article number
40 x 780	10	A100	220	36	38544
		A65	280	40	38545
		A45	400	50	38546
		A30	600	60	38547
		A16	1200	80	38548

Technical specifications Trizact™ belt suitable for ROHR MAX® AKKU

Dimensions (mm)	Pkg. unit 	Grit (Trizact™)	Grit (K)	Material removal (like approx. K)	Article number
30 x 533	10	A100	220	36	38085
		A65	280	40	38086
		A45	400	50	38087
		A30	600	60	38088
		A16	1200	80	38089

Technical specifications Trizact™ belt suitable for BAND-IT and BAND-IT AKKU

Dimensions (mm)	Pkg. unit 	Grit (Trizact™)	Grit (K)	Material removal (like approx. K)	Article number
9 x 533	10	A100	220	36	49034
		A65	280	40	49035
		A45	400	50	49036
		A30	600	60	49037
		A16	1200	80	49038
		A06	2000	120	49039



SUITABLE FOR ALL METALS

BRIGHTEX® Polishing Belts

Berry & Sun



Polishing material that is already impregnated with BRIGHTEX® polishing paste removes the time-consuming hassle of applying pastes and creams to give untreated metal a shadow-free mirror finish. Can be used immediately without additional pastes and creams!

Benefits at a glance

Step 1: BRIGHTEX® Berry (pre-polishing):

- For applying a rapid high-gloss polish to all metals.
- Pre-polish and main polish in one – save on additional operations.

Step 2: BRIGHTEX® Sun (main polish):

- A mirror finish that's almost like chrome plating – perfect finish.
- For a final high-gloss shine on polished metals.
- For removing any residual clouding and smears from all metals.

Please note:

After changing pastes, always remove the polish residue from the work-piece! As necessary, the backing can be re-wetted with BRIGHTEX® pastes (see page 215).

- For reconditioning high-gloss surfaces which have been polished mechanically.
- Ideal for use with polishing machines and hand-held polishing tools.
- For the best results, use Eisenblätter care and cleaning products for removing polish residues (see BRIGHTEX® Softclean Powder page 216, POWER CLEANER page 219).
- Completely new high-tech paste formulation for metals.
- For immediate use without additional pastes and creams!

Technical specifications BRIGHTEX® polishing belts suitable for ROHR MAX®, ROHR SNIPER®, GLADIUS® and TOPRAIL 1100 HT

Version	Application	Dimensions (mm)	Material thickness (mm)	Pkg. unit 	Article number
Berry (pink)	High-gloss polishing	40 x 780	5	4	38551
Sun (yellow)	Mirror-finish polishing	40 x 780	5	4	38552

Technical specifications BRIGHTEX® polishing belts suitable for ROHR MAX® AKKU

Version	Application	Dimensions (mm)	Material thickness (mm)	Pkg. unit 	Article number
Berry (pink)	High-gloss polishing	30 x 533	5	4	38091
Sun (yellow)	Mirror-finish polishing	30 x 533	5	4	38092

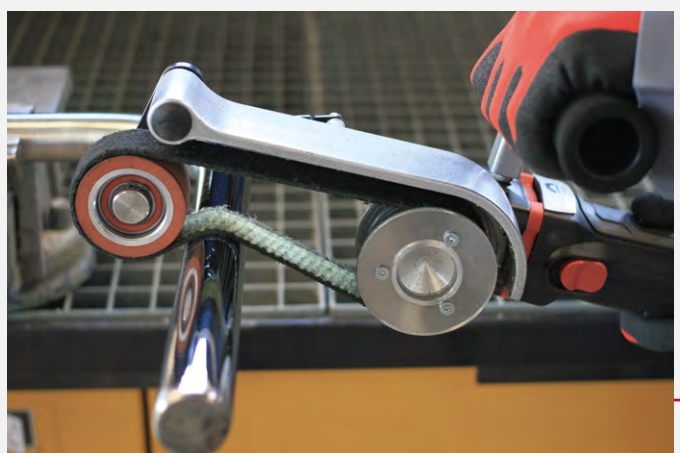

SUITABLE FOR ALL METALS

SuperPolish Belt

Revolutionary special fleece

Used with polishing pastes and creams for a **shiny mirror finish** on stainless steel and non-ferrous metals which leaves **no smears or shadows**.
Polishing pastes and cream see pages 215 and 218.

Please note: Always use a separate sleeve for each paste and cream – it is important not to mix different grit sizes.



Technical specifications SuperPolish belt suitable for ROHR MAX®, ROHR SNIPER®, GLADIUS® and TOPRAIL 1100 HT

Dimensions (mm)	Material thickness (mm)	Material	Pkg. unit 	Article number
40 x 780	5	Polishing fleece	4	38550

Technical specifications SuperPolish belt suitable for ROHR MAX® AKKU

Dimensions (mm)	Material thickness (mm)	Material	Pkg. unit 	Article number
30 x 533	5	Polishing fleece	4	38090



SUITABLE FOR ALUMINUM - NON-FERROUS METALS - HARD PLASTICS

Felt Belt



Closed Merino felt belts for tasks from **main polishing to mirror finishing of stainless steel and non-ferrous metals**.
Polishing pastes and cream see pages 215 and 218.

Please note: Do not use different pastes or creams on the same felt belt.

Technical specifications felt belt suitable for BAND-IT and BAND-IT AKKU

Dimensions (mm)	Material thickness (mm)	Material	Pkg. unit 	Article number
9 x 533	5	Merino felt	10	49015

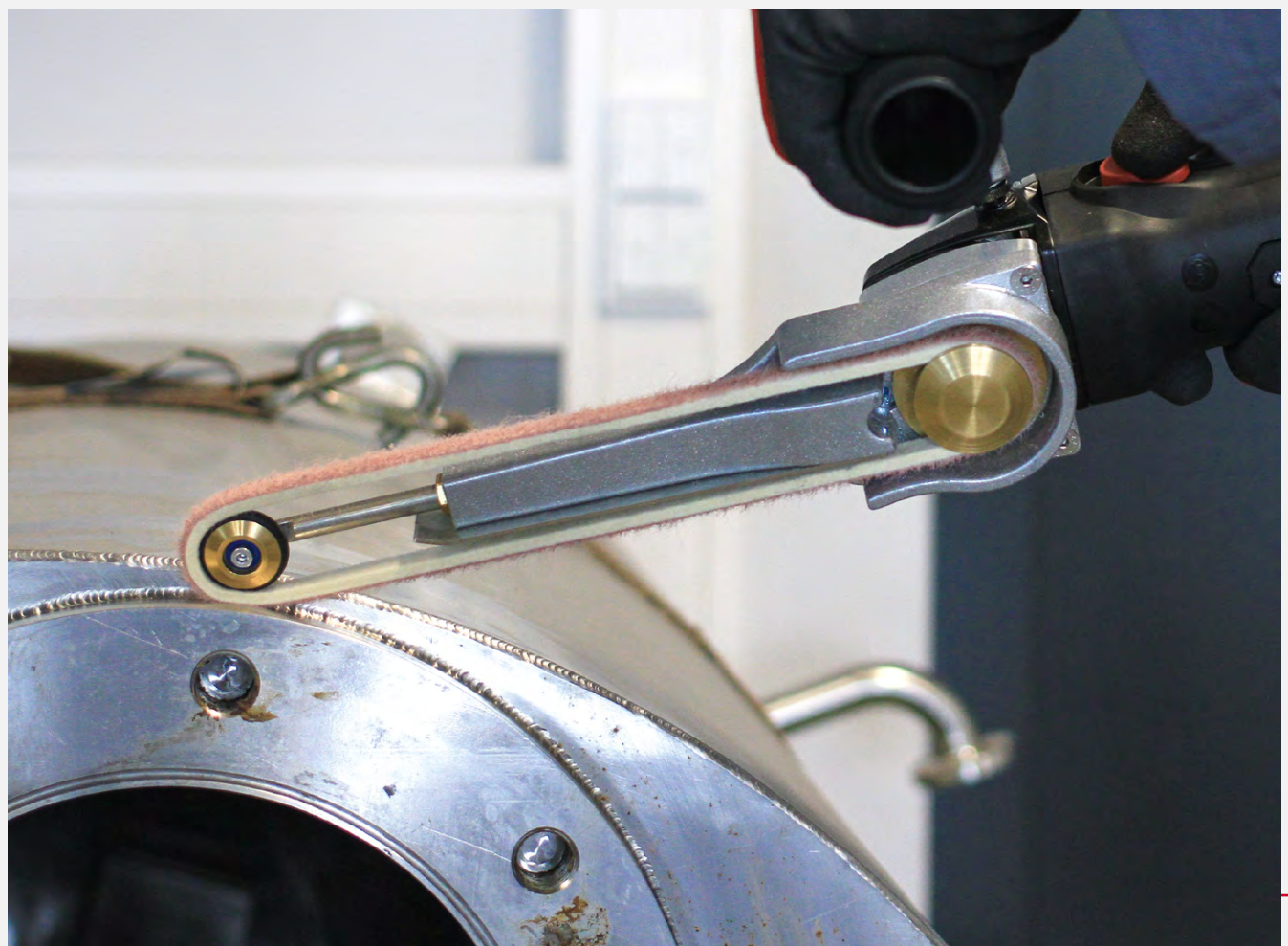



DEBURRING AND BEVELLING

ROLEI DEBURRING AND BEVELLING DEVICES . . 202

NEW ROLEI EF 115 PROFESSIONAL 202
ROLEI EF 165 204
ROLEI PEF 500 206
ROLEI BE 5 sheet metal deburring machine 208
Accessories 210



ROLEI DEBURRING AND BEVELLING DEVICES

Mains powered machines

SUITABLE FOR DEBURRING AND BEVELLING

NEW

ROLEI EF 115 PROFESSIONAL

Manual deburring and beveling tool



The **practical deburring tool** for cumbersome, large, heavy components such as machine tables, frame constructions, and large metal panels. **Easy to handle** with good edge control. The ROLEI EF 115 is also ideal for weld chamfering. Fixed bevel angle of 45°; **bevel width can be infinitely adjusted** from 0 to 10 mm. Now with a rubberised handle for excellent control! The handy ROLEI EF 115 can easily de-burr and bevel large, heavy components. Precision edge guidance guarantees **chamfers at 45° with no counter-burr**.

Benefits at a glance

- **Extremely powerful motor for continuous use.**
- Particularly **sturdy, wear-resistant, milled parts.**
- **Quick adjustment of bevel width from 0 to 10 mm.**
- **45° faceting angle.**
- **Balanced handle** reduces strain on the user.
- Quick, **uncomplicated disc change.**
- Various tool grit grades (coarse to fine) can be delivered.
- **Ideal for chamfering welds. Also suitable for wide weld bevels.**



ROLEI DEBURRING AND BEVELLING DEVICES

Mains powered machines

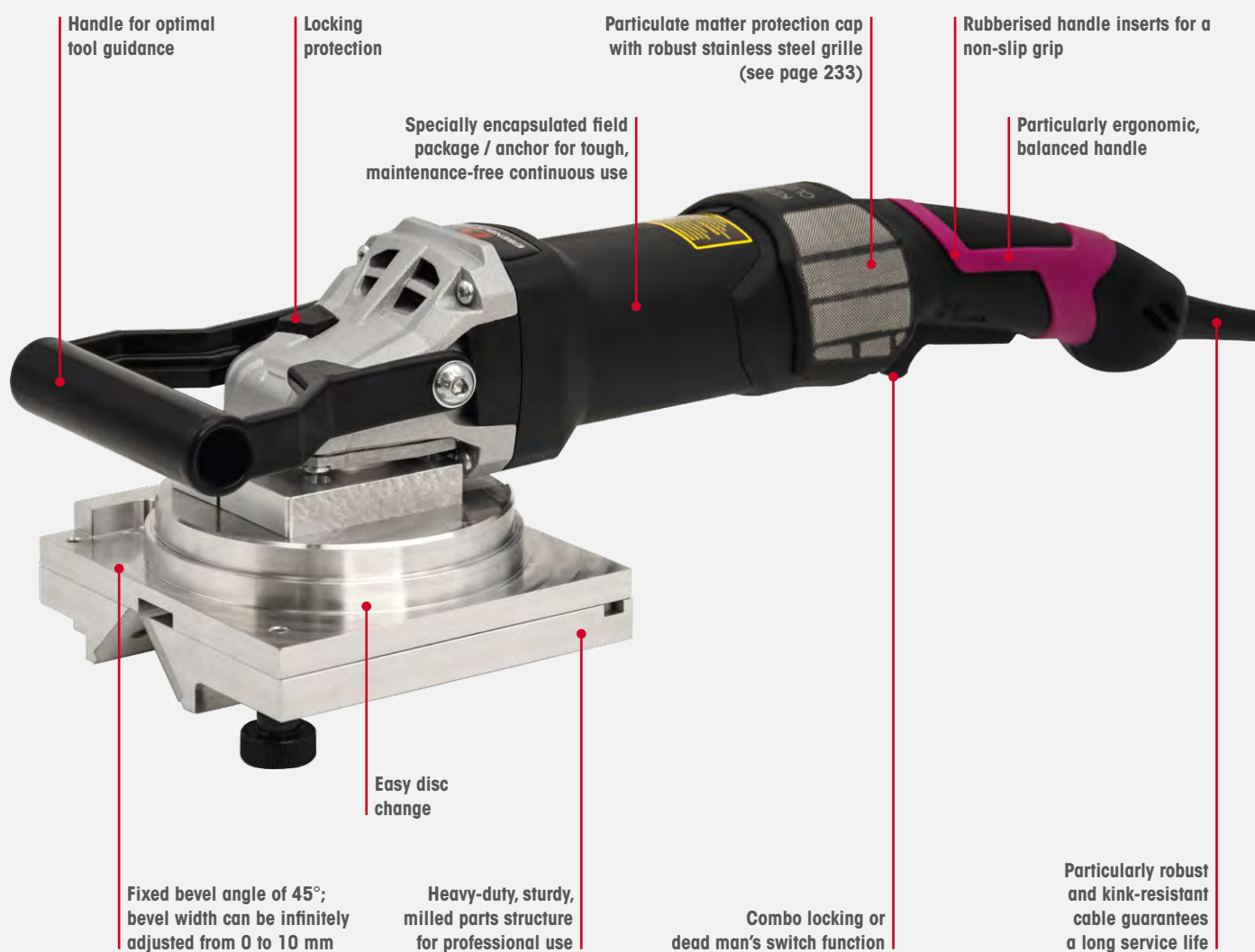

DEBURRING AND BEVELLING

Technical specifications **ROLEI EF 115 PROFESSIONAL basic device**

Plug type	Cable type	Mains connection (V ~ Hz)	Power (W)	Speed (rpm)	Bevel angle	Bevel width (mm)	Weight (kg)	Pkg. unit 	Article number
EU (C+F)	Permanent connection	220 – 240 ~ 50-60	1,750	2,400 – 8,900	45°	0 – 10	3.9	1	30150

- Scope of delivery:**
- 1 ROLEI EF 115 PROFESSIONAL basic device
 - 1 Robust, impact-resistant plastic case
 - 1 Particulate matter protection cap
 - 1 Clamping nut
 - 1 Chuck key
 - 1 Deburring flap disc

Replacement disc for **ROLEI EF 115 PROFESSIONAL**: ZIRCOTEX® Nylon Plan (see page 54)

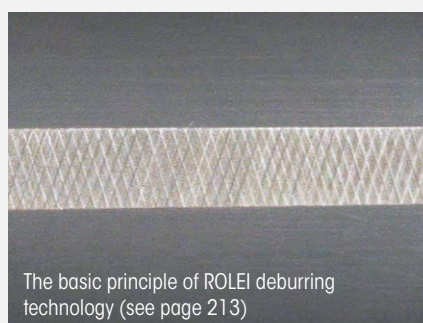

ROLEI DEBURRING AND BEVELLING DEVICES

Mains powered machines

SUITABLE FOR DEBURRING AND BEVELLING

ROLEI EF 165

for bevels of 45°

Bevelling and deburring machine with fixed bevel angle and infinitely adjustable bevel width for all metals from stainless steel to aluminium. A hand wheel provides infinite, precise bevel width setting. Eisenblätter was awarded the Bavarian State Prize for its deburring machine at the Internationale Handwerksmesse show in Munich.



Benefits at a glance

- **Simple, safe operation.**
- **Low-cost replacement grinding disc** with an extremely long service life (one disc can often be used for months).
- **Bevelling of work-pieces of 2.5 mm or more in thickness.**
- **Suction flange for industrial extractors supplied as standard (internal diameter 35 mm).**
- **Winner of the Bavarian State Prize.**

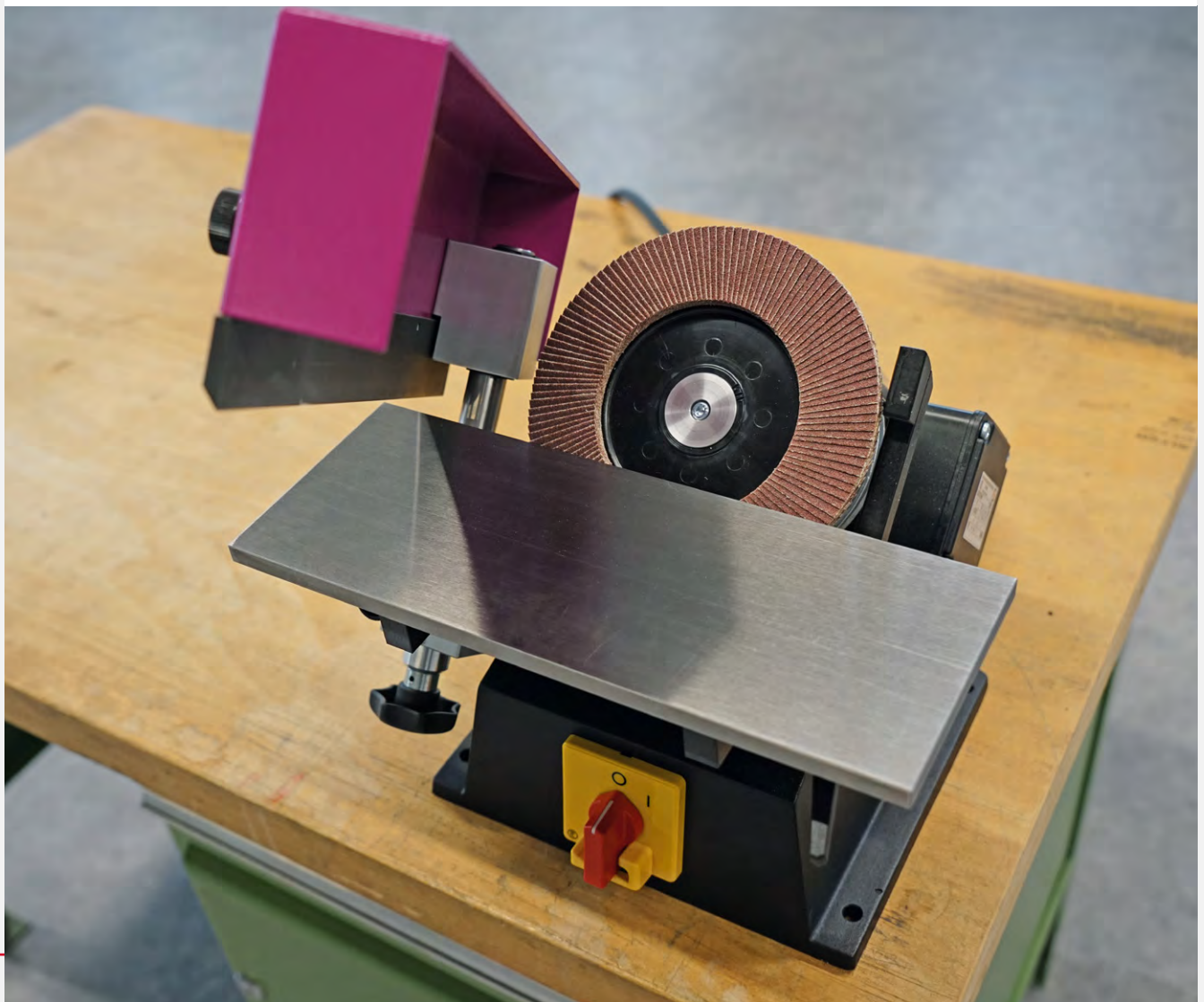

ROLEI DEBURRING AND BEVELLING DEVICES

Mains powered machines

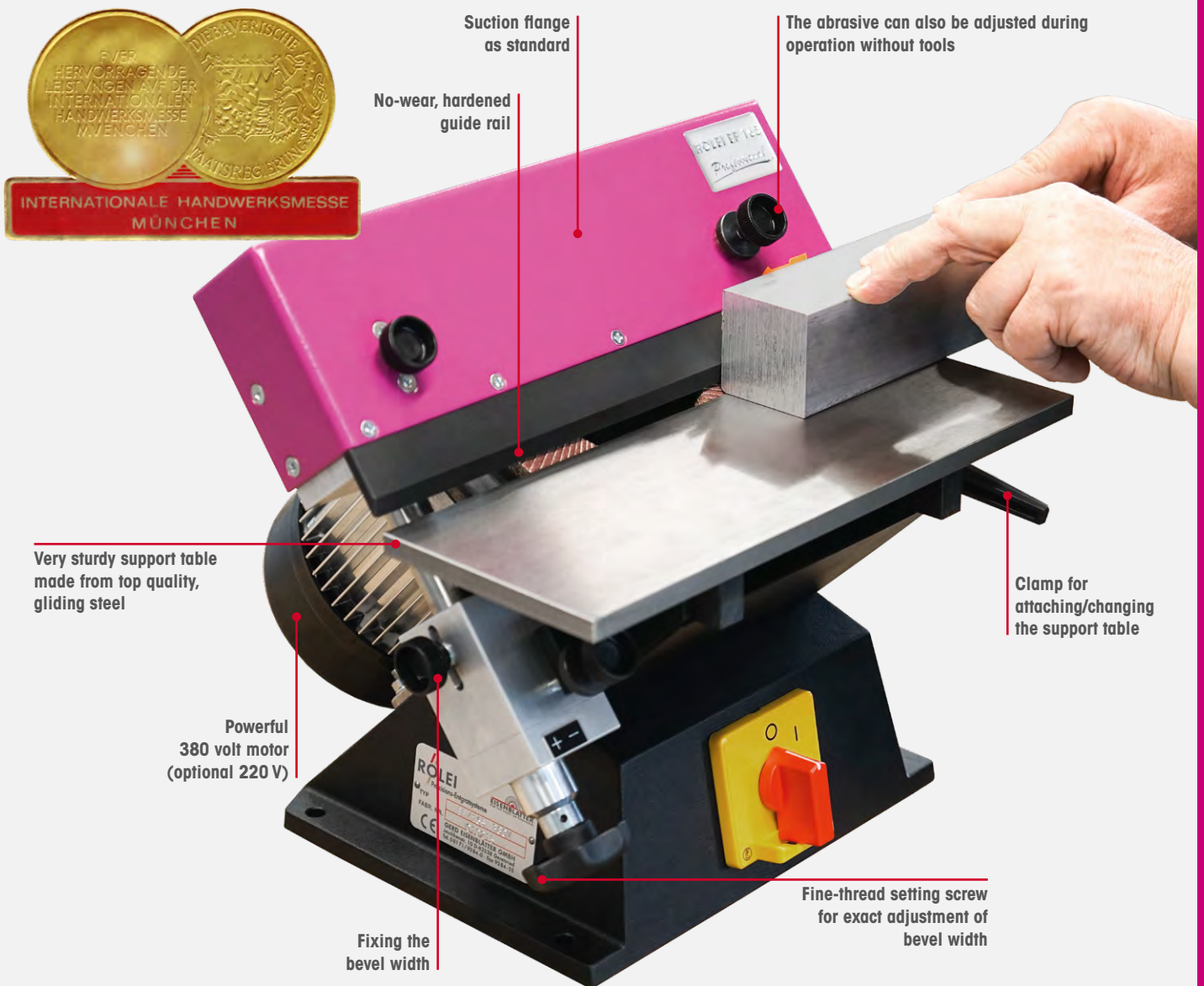

Technical specifications **ROLEI EF 165 basic device**

Dimensions (mm)	Plug type	Mains connection (V ~ Hz)	Speed (rpm)	Bevel angle	Bevel width (mm)	Weight (kg)	Pkg. unit 	Article number
360 x 320 x 300	3-phase	380 ~ 50	2,800	45°	0 - 10	18	1	30100
360 x 320 x 300	EU (C+F)	220 - 240 ~ 50-60	2,800	45°	0 - 10	18	1	30101

Scope of delivery:
 1 ROLEI EF 165 basic device
 1 ROLEI special flap disc

Replacement disc for ROLEI EF 165:
 ROLEI special flap disc, page 211



Suitable for all metals:
 ROLEI HellFire® special flap disc, page 211



ROLEI DEBURRING AND BEVELLING DEVICES

Mains powered machines

SUITABLE FOR DEBURRING AND BEVELLING

ROLEI PEF 500

for facets of 30° – 45° – 60°

Very **sturdy, highly precise deburring and beveling tool** for all metals from stainless steel to aluminium. **Bevel angle can be set and bevel width is infinitely adjustable** (precision setting by means of knurled division). The bevel width can be adjusted precisely using a hand wheel. Parts are bevelled in **perfect cross-hatched grinding with absolutely no counter-burr**. Disc wear is adjusted with a hand wheel via a threaded spindle. The bevel angle is adjusted using a motorised system on the angled guide.



Benefits at a glance

- **Simple, safe operation.**
- **Low-cost replacement grinding disc** with an extremely long service life (one disc can often be used for months).
- **Suction flange for industrial extractors supplied as standard (internal diameter 35 mm).**
- Beveling of work-pieces of 2.5 mm or more in thickness.

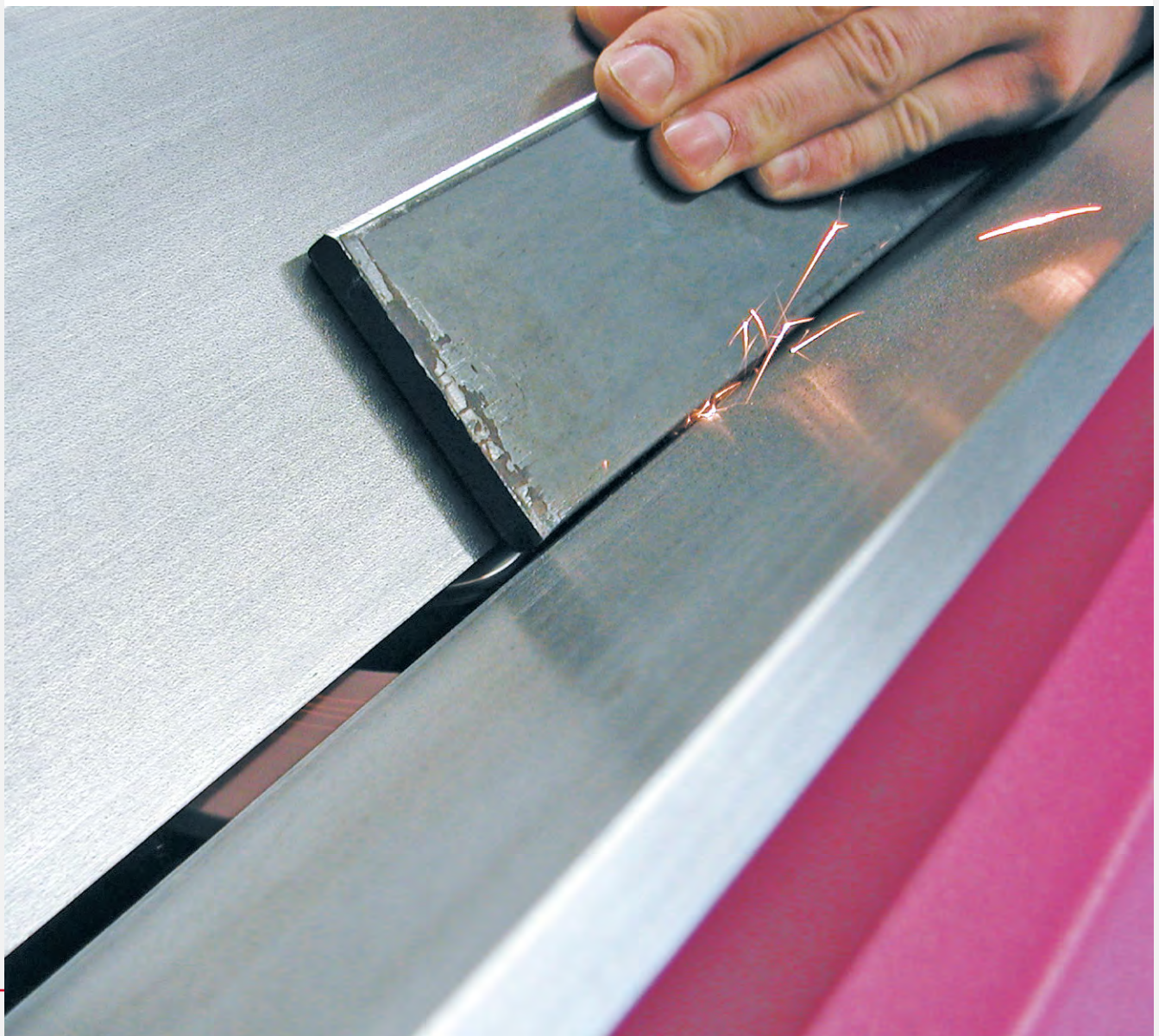

ROLEI DEBURRING AND BEVELLING DEVICES

Mains powered machines

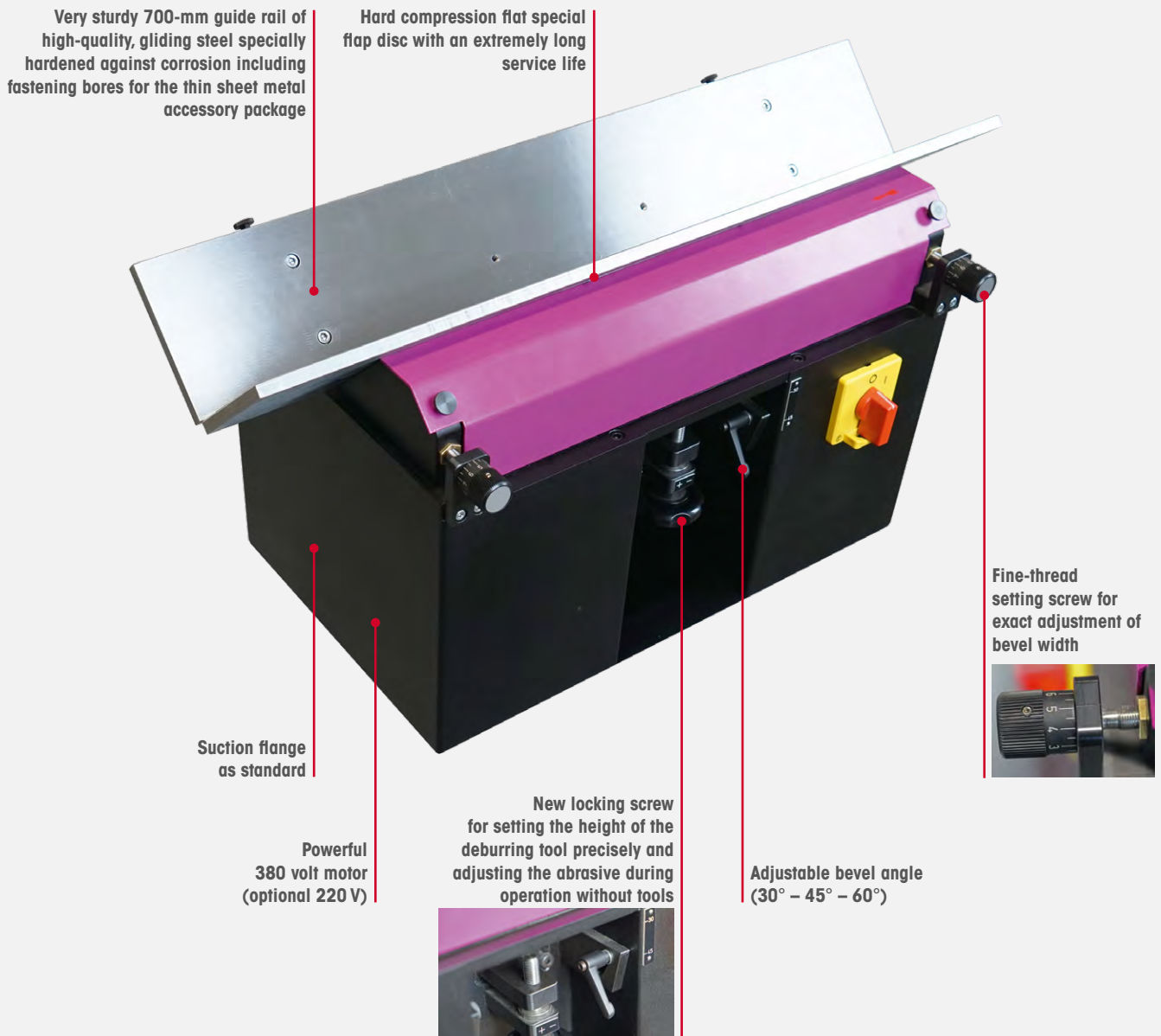

Technical specifications **ROLEI PEF 500 basic device**

Dimensions (mm)	Plug type	Mains connection (V ~ Hz)	Speed (rpm)	Bevel angle	Bevel width (mm)	Weight (kg)	Pkg. unit 	Article number
500 x 350 x 350	3-phase	380 ~ 50	2,800	30° – 45° – 60°	0 – 10	45	1	30200
500 x 350 x 350	EU (C+F)	220 – 240 ~ 50-60	2,800	30° – 45° – 60°	0 – 10	45	1	30201

Scope of delivery: 1 ROLEI PEF 500 basic device
1 ROLEI special flap disc

Replacement disc for ROLEI EF 165:
ROLEI special flap disc, page 211



Suitable for all metals:
ROLEI HellFire® special flap disc, page 211



Optional:
Machine stand for comfortable working while standing, see page 230



ROLEI DEBURRING AND BEVELLING DEVICES

Mains powered machines

SUITABLE FOR DEBURRING SHEET METAL PARTS

ROLEI BE 5

Sheet metal deburring machine

The ideal workbench or free-standing tool for quick deburring of all metals (including stainless steel) on both sides up to approx. 5 mm of sheet thickness in one operation.

Please note: To prevent damage to the ROLEI BE 5 transmission system, use only original ROLEI flap wheels with 100% cotton fabric, see page 212.



Benefits at a glance

- **Simple, safe operation** without prior familiarity.
- **2 speeds** available (600 and 1,200 rpm).
- **Powerful 380-volt three-phase motor for continuous operation.**
- **Sturdy aluminium transmission** with spindle mounts for replacement tools.
- **1 set (2 units) of flap wheels deburrs about 2000 m of sheet stainless steel.**
- Replacement tools are easy to change.
- **Suction flange for industrial extractors** supplied as standard (internal Ø 35 mm).
- Wear-free, hardened guide rail (infinitely adjustable).

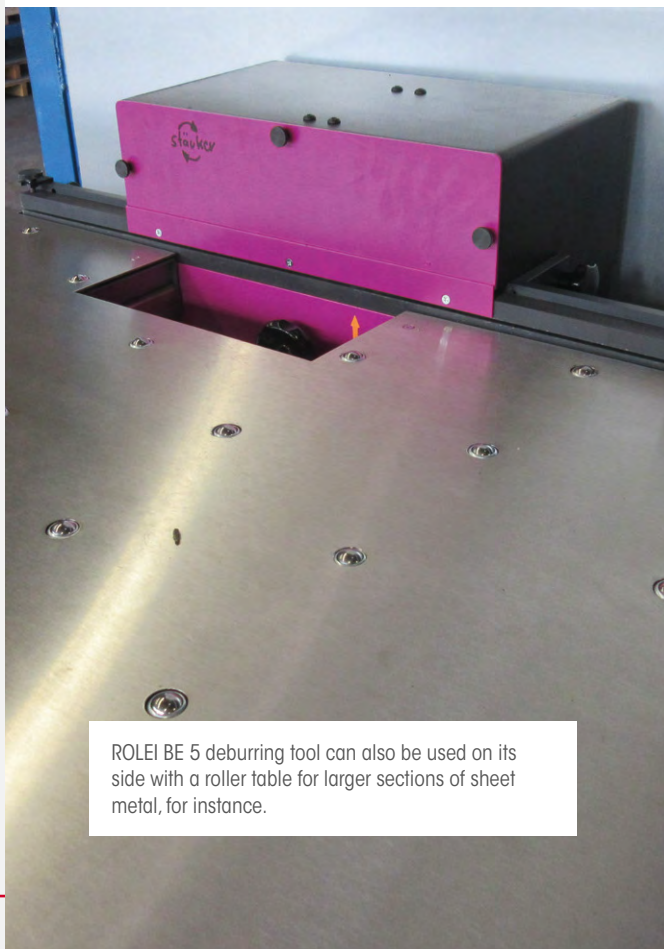

ROLEI BE 5 deburring tool can also be used on its side with a roller table for larger sections of sheet metal, for instance.

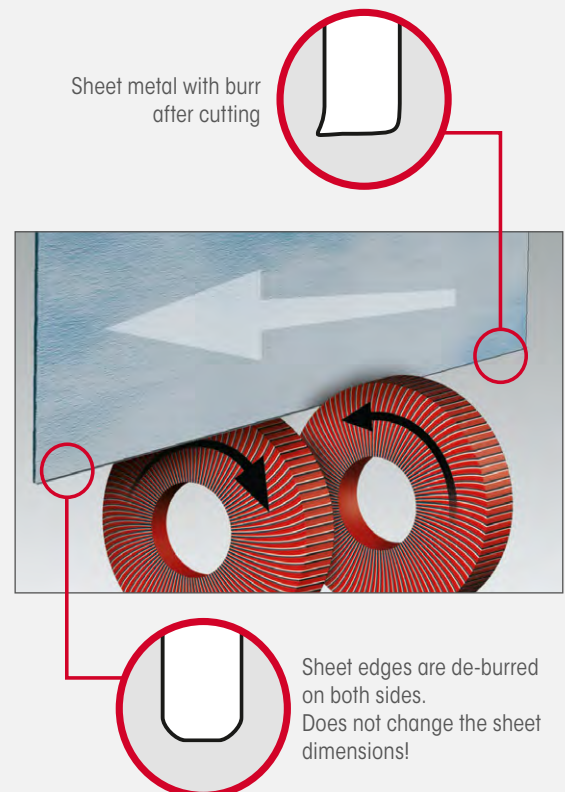

ROLEI DEBURRING AND BEVELLING DEVICES

Mains powered machines

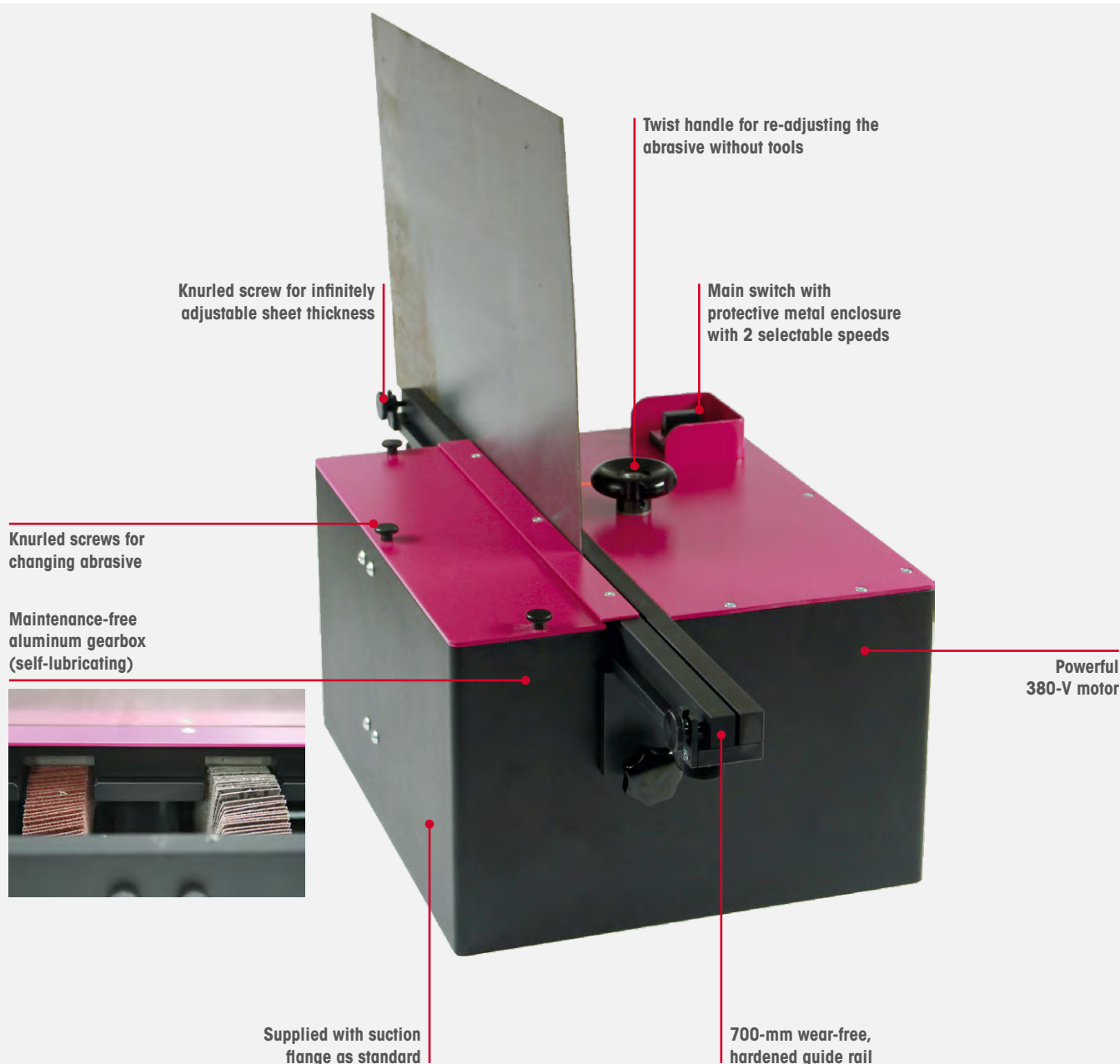

DEBURRING AND BEVELLING

Technical specifications **ROLEI BE 5 basic device**

Dimensions (mm)	Plug type	Mains connection (V ~ Hz)	Power (W)	Speed (rpm)	Sheet metal thickness (working mm)	Weight (kg)	Pkg. unit 	Article number
700 x 325 x 200	3-phase	380 ~ 50	750	Setting 1: Fine deburring 600 Setting 2: Standard deburring 1,200	0 - 5	29	1	30310

Scope of delivery:

- 1 ROLEI PEF 500 basic device
- 2 ROLEI BE 5 flap wheels

Replacement wheel for ROLEI BE 5:
ROLEI BE 5 flap wheel (see page 212)

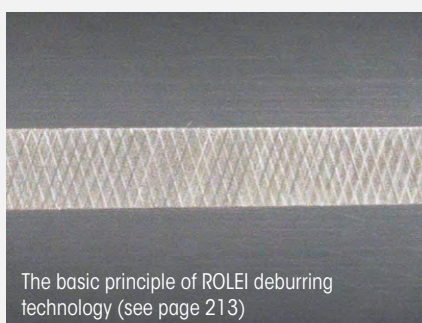

The basic principle of ROLEI deburring technology (see page 213)

Optional:
Machine stand for comfortable working while standing, see page 230



ROLEI DEBURRING AND BEVELLING DEVICES

Accessories

SUITABLE FOR ROLEI EF 165

Extended Support Table

Made from gliding steel (1.2842).

Technical specifications

Dimensions (mm)	Pkg. unit 	Article number
120 x 700	1	30110
Other dimensions available on request.		



SUITABLE FOR ROLEI EF 165 · ROLEI PEF 500 · ROLEI BE 5

Teflon Strips

self-adhesive

For the guide rail. To protect against scratches on the work-piece/sheets!

Technical specifications

Dimensions (mm)	Material	Pkg. unit 	Article number
20 x 700	Teflon	10	30341



SUITABLE FOR STEEL · STAINLESS STEEL · NON-FERROUS METALS

ROLEI Special Flap Disc

The flap disc with **especially hard compression for deburring machines.**
Self-sharpening with an extremely long service life!

Important: Conventional flap discs are not suitable for deburring machines due to springback.



Technical specifications

Dimensions (mm)	Can be used with	Pkg. unit 	Grit (K)	Article number
170 x 22	ROLEI EF 165, ROLEI PEF 500	1	50	36050
			60	36060
			80	36080
			120	36120

Choosing the right grit/disc:

Stainless steel, steel K50/K60
Aluminum, copper, brass K80/K120
Hard plastics K120



SUITABLE FOR ALL METALS

ROLEI HellFire® Special Flap Disc

Ceramic hybrid:
1 disc + 1 grit for all metals

Ceramic hybrid disc with hard compression for **particularly high rate of metal removal** in one operation. Suitable for larger bevel widths due to high disc aggressivity. **Coarse to medium application; grinds all metals** from steel to stainless steel to titanium to non-ferrous metals.

Important: Conventional flap discs are not suitable for deburring machines due to springback.



Technical specifications

Dimensions (mm)	Can be used with	Pkg. unit 	Grit (K)	Article number
170 x 22	ROLEI EF 165, ROLEI PEF 500	1	Multigrain 40/60	36046

Choosing the right grit/disc:

All metals Multigrain 40/60



ROLEI DEBURRING AND BEVELLING DEVICES

Accessories

SUITABLE FOR ALL METALS

ROLEI BE 5 Flap Wheel

Replacement grinding flap wheels, 100% cotton quality, for great deburring. Cotton design ensures that the wheel can be used for a particularly wide range of applications and ideal employment of grinding tools.

Please note: To prevent damage to the ROLEI BE 5 transmission system, use only original ROLEI flap wheels with 100% cotton fabric.



Technical specifications

Dimensions (mm)	Pkg. unit 	Grit (K)	Article number
165 x 30	2	40	37040
		60	37060
		80	37080
		120	37120



The basic principle of ROLEI deburring technology

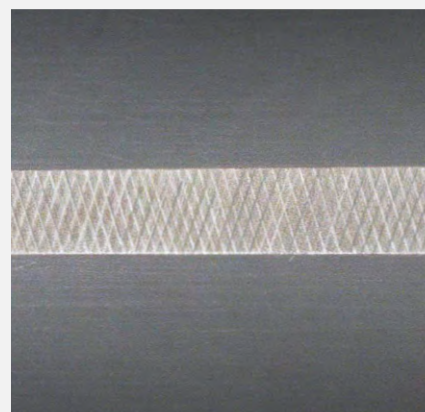
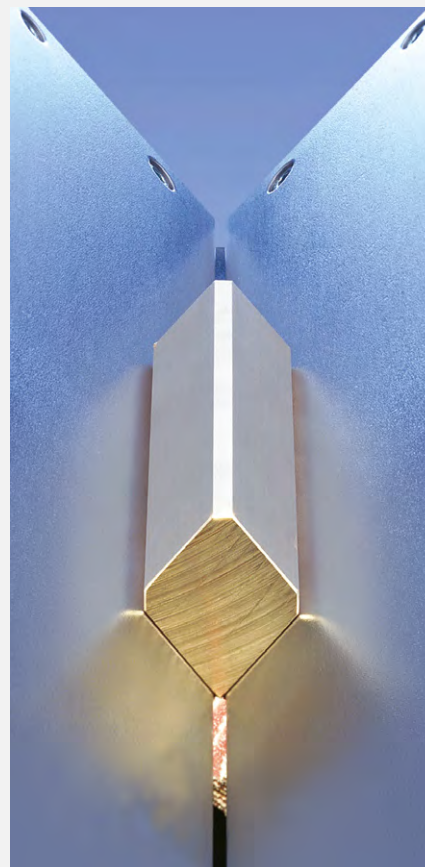
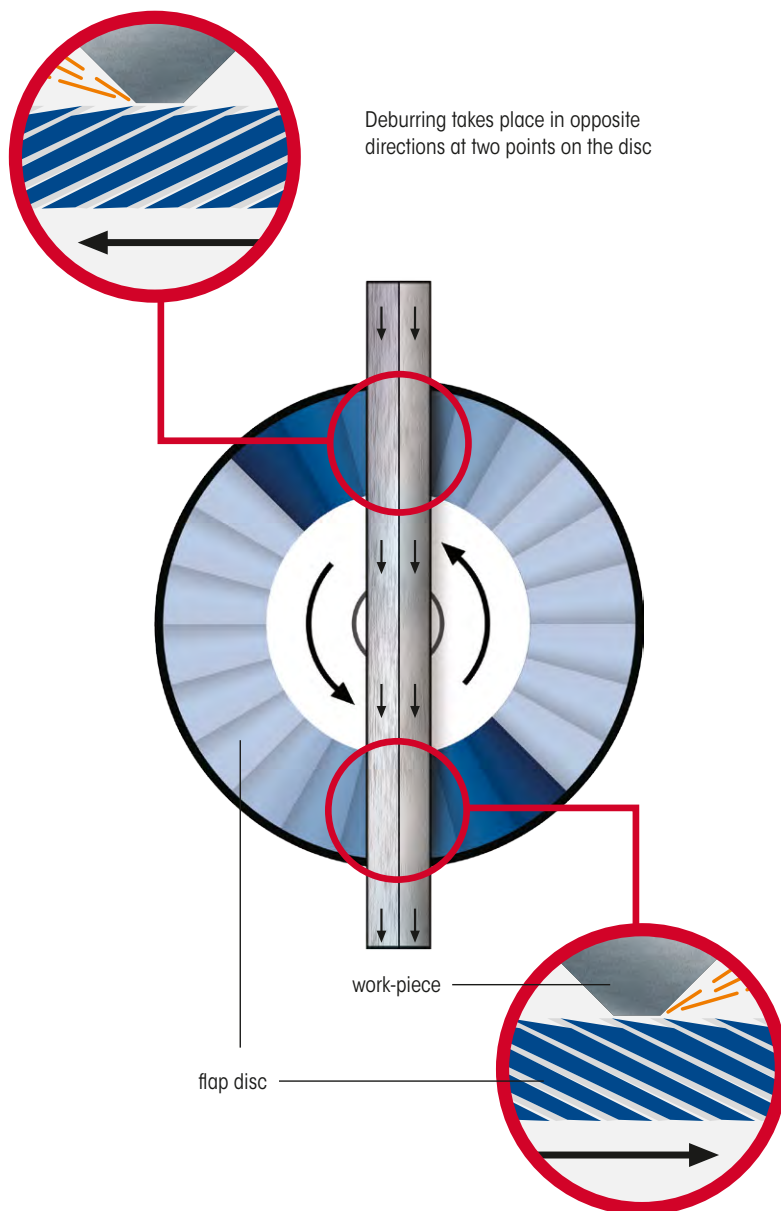

Basic principle:

Grinding instead of milling saves a considerable amount of time and tool costs. Perfect cross-grinding in one operation guarantees edges with no counter-burr or chatter marks.

All metals, including stainless steel, can be worked with this flexible deburring tool. ROLEI deburring and bevelling machines work with flat flap discs (the BE 5 sheet metal deburring machine with flap wheels). The grinding tools are "self-sharpening" and have an extremely long service life.

The machines are easy and safe to operate and the grinding tools can be changed quickly and easily.

CARE PRODUCTS

BRIGHTEX® POLISHING SYSTEM 215

- BRIGHTEX® high-performance polishing pastes.215
- BRIGHTEX® Softclean Powder216
- BRIGHTEX® microfibre cloth216

POLISHING 218

- Polishing pastes classic.218
- Pink polishing cream.218

CLEANING 219

- POWER CLEANER.219
- BRILLIANCE CLEAN.220

PROTECTING 221

- INOX PROTECT (hard wax, dry).221

PRESERVING 222

- POLY SCHUTZ (oil film)222

GRINDING ADDITIVES 223

- KANGAROO ALU-FIX oil223

TEST SETS 224

- Indoor test set224
- Outdoor test set.224



SUITABLE FOR ALL METALS

BRIGHTEX® High-Performance Polishing Pastes

The fastest way to a mirror finish

For the first time, the pre-polishing and main polishing steps can be completed with just one paste (BRIGHTEX® Berry)! This has been made possible by a completely new formulation. For instance, stainless steel can be polished to a mirror finish in only a few moments. **This saves several working steps. The yellow BRIGHTEX® Sun paste creates an even brighter high gloss shine – almost as if it's chrome plated.** Both pastes can be used on SuperPolish discs and belts and on felt discs, belts, and sleeves. The pastes are applied to the polishing disc, belt, or sleeve while it is running at a low speed so that it is completely covered. This process can be repeated several times. The pastes can also be used for the new BRIGHTEX® polishing system (pre-impregnated polishing discs, belts, and sleeves) to "top up" the polishing fleeces as required.



Benefits at a glance

Step 1: BRIGHTEX® Berry (pre-polishing):

- For applying a rapid high-gloss polish to all metals.
- Pre-polish and main polish in one – save on additional operations.

Step 2: BRIGHTEX® Sun (main polish):

- A mirror finish that's almost like chrome plating – perfect finish.
- For a final high-gloss shine on polished metals.
- For removing any residual clouding and smears from all metals.

Please note:

After changing pastes, always remove the polish residue from the work-piece!

- For reconditioning high-gloss surfaces which have been polished mechanically.
- Ideal for use with polishing machines and hand-held polishing tools.
- For the best results, use Eisenblätter care and cleaning products for removing polish residues (see BRIGHTEX® Softclean Powder page 216, POWER CLEANER page 219).
- Completely new **high-tech paste formulation** for metals.
- For immediate use without additional pastes and creams!

Technical specifications

Item	Contents (g)	Application	Pkg. unit 	Article number
BRIGHTEX® Berry pre- and main polish (pink)	approx. 1,100	High-gloss polishing	1	40025
BRIGHTEX® Berry mini paste (pink)	approx. 140	High-gloss polishing	1	40025m
BRIGHTEX® Sun post-polishing paste (yellow)	approx. 1,000	Mirror-finish polishing	1	40026
BRIGHTEX® Sun mini paste (yellow)	approx. 140	Mirror-finish polishing	1	40026m



SUITABLE FOR ALL METALS

BRIGHTEX® Softclean Powder

A new, much improved cleaning powder removes all cream and paste residue after every polish, giving all metals a polished, completely scratch-free shine. Simply apply a little using the shaker, as you would powdered sugar, and wipe it off with a **clean microfibre cloth** without applying any pressure. The powder consists of **ultra-fine micro-particles** with a large surface area for the **best possible absorbency**.



Technical specifications

Packaging	Contents (g)	Pkg. unit	Article number
Plastic can	approx. 1,000	1	40028
Aluminum shaker	approx. 200	1	40029

SUITABLE FOR ALL MATERIALS

BRIGHTEX® Microfibre Cloth

Much improved, **ultra-soft microfibre cloth**, free of seams for completely **scratch-free cleaning of stainless steel surfaces** and other **decorative metals**. Particularly soft and absorbent. Can be washed repeatedly.



Technical specifications

Dimensions (mm)	Quality	Pkg. unit	Article number
400 x 400	360 g/m ²	5	40031





SUITABLE FOR ALL METALS

Polishing Pastes Classic

Mirror-finish polishing for all metals (including aluminium).
White for pre-polishing, blue for final polish.

Technical specifications

Item	Contents (g)	Pkg. unit 	Article number
Pre-polishing paste (white)	approx. 650	1	40013
Polishing paste (blue)	approx. 650	1	40014
Mini pastes (white and blue)	approx. 120 (60 each)	1	40009



SUITABLE FOR ALL METALS

Pink Polishing Cream

For final polishing, with Classic polishing pastes, for example, it produces a flawless mirror finish on all metals when applied with SuperPolish, felt, and polishing rings. Brings a quick shine – also suitable for manual application with polishing cloths. Ideal for moulded parts as well.

Technical specifications

Packaging	Contents	Pkg. unit 	Article number
Can	approx. 1.000 g	1	40015
Mini-tube	approx. 60 ml	1	40015t

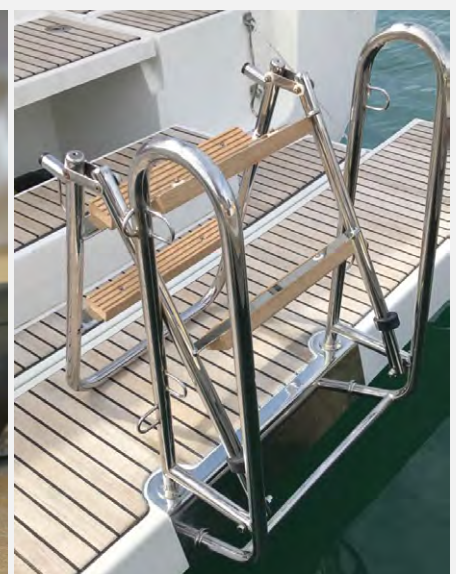

SUITABLE FOR ALL METALS

POWER CLEANER

Universal cleaner in its most environmentally-friendly form

Clean and preserve – especially for the removal of grease-based polish residue (BRIGHTEX® pastes).

Benefits at a glance

- **Water-based** for removing mineral soiling.
- Removes oil, grease and polish/paste residue from metal surfaces.
- Removes cement and adhesive residue and lime film.
- **Universally applicable.**
- **No labels according to the CLP and REACH Regulation, free of VOC.**
- **Solvent-free application.**



Technical specifications

Packaging	Contents	Pkg. unit 	Article number
Spray bottle	50 ml	1	40057
	500 ml	4	40055
Canister (incl. spray bottle)	5 litres	1	40056

Larger quantities on request.



Quick, simple removal of paste and polish residues, stubborn soiling, and adhesive and oil residue.

SUITABLE FOR ALL METALS · PAINTED SURFACES · HARD PLASTICS · WOOD · GLASS · ACRYLIC

BRILLIANCE CLEAN

Streak-free cleaning of ground and unground metal surfaces

Quickly removes all kinds of minor contaminants from all metals, including stainless steel, aluminium, copper, and brass, but also glass, wood, hard plastics, and much more. **Evaporates quickly**, leaving all surfaces **free of streaks and residue**. Particularly suited to stainless steel surfaces. Can also be used for any other cleaning jobs, even around the house. It is the quickest and most effective solution. BRILLIANCE CLEAN is **completely environmentally friendly and non-toxic**. Try it once and you won't want to be without this time-saving cleaning aid ever again! No more water cleaning!



Technical specifications

Packaging	Contents	Pkg. unit 	Article number
Spray bottle	50 ml	1	40050m
	500 ml	4	40050
Canister (incl. spray bottle)	5 litres	1	40051

Larger quantities on request.

Quick, streak-free cleaning for a variety of surfaces.

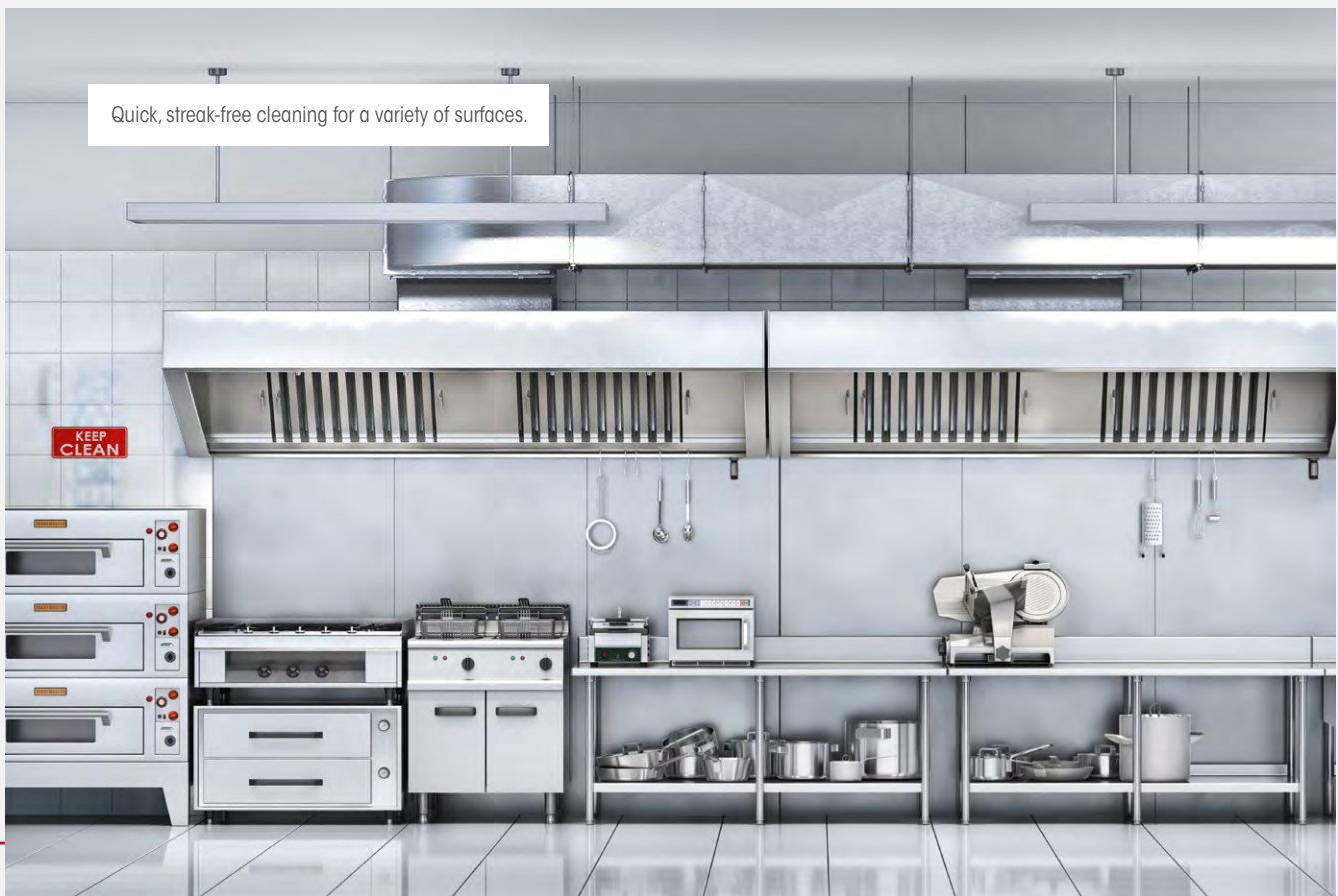

SUITABLE FOR ALL METALS INDOORS

INOX PROTECT (hard wax, dry)

2 functions in one! Clean + Seal

The smartest way to protect and optically upgrade stainless steel – an absolute necessity for all stainless steel surfaces!

Quickly cleans and provides long-term protection from fingerprints and stains for decorative surfaces, giving them a transparent, protective layer of hard wax. Ideal for visible stainless steel surfaces of all kinds, kitchen panelling, ground stainless steel lift walls, railings, rods, pipes, stainless steel tables, and much more. Can also be used for all other metals. Spray it onto parts and distribute it by rubbing with a microfibre cloth; after a few seconds, polish with a second dry microfibre cloth. **All parts will look completely new** and can simply be re-polished dry at any time until the agent is re-applied.



Technical specifications

Packaging	Contents	Pkg. unit 	Article number
Spray bottle	50 ml	1	40040m
	500 ml	4	40040
Canister (incl. spray bottle)	5 litres	1	40041

Larger quantities on request.



SUITABLE FOR STAINLESS STEEL - NON-FERROUS METALS INDOORS AND OUTDOORS

POLY SCHUTZ (oil film)

Cleaning and preserving

Ideal for **decorative outdoor stainless steel surfaces** such as stainless steel doors, facades, railings, fountains, figures, artworks, large kitchens, and the hotel industry. Practical spray bottle for ideal dosing and effective application (can be refilled). For cleaning and preserving ground and polished surfaces. Finger smudges, water spots, and shadows remain invisible for a long time. For outdoors and the food sector (**food-grade**).



Technical specifications

Packaging	Contents	Pkg. unit 	Article number
Spray bottle	50 ml	1	40011m
	500 ml	4	40011
Canister (incl. spray bottle)	5 litres	1	40012

Larger quantities on request.

Protect from water spots in the outdoor area for a long time.



SUITABLE FOR ALUMINUM

KANGAROO ALU-FIX Oil

Special oil for machining aluminum

This unique special oil for machining aluminum prevents flap discs from smearing and increases service life and performance by up to 300%. Simply spray the agent onto the work-piece before grinding and grind as normal!



Technical specifications

Packaging	Contents	Pkg. unit 	Article number
Spray bottle	50ml	1	40010m
	500 ml	4	40010
Canister (incl. spray bottle)	5 litres	1	40010k

Larger quantities on request.



SUITABLE FOR INDOOR USE

Indoor Care Test Set

Pore-deep cleaning and long-term protection for indoor metals

The environmentally friendly **POWER CLEANER** removes even stubborn contamination such as cement and adhesive residue and lime film and, immediately after polishing, polishing paste and cream residue. **BRILLIANCE CLEAN** removes minor contamination, completely streak-free and without residue. For final surface sealing, **INOX PROTECT** is applied to form a transparent hard wax layer that provides long-term protection from fingerprints and spots to such metal surfaces as stair railings, lifts, and doorbell panels. **Test it yourself!**



Technical specifications

Application	Packaging	Contents	Pkg. unit	Article number
Indoors	Spray bottles	3 x 50 ml	1 	40060

SUITABLE FOR INDOOR AND OUTDOOR USE

Outdoor Care Test Set

Pore-deep cleaning and long-term protection for indoor and outdoor metals

The environmentally friendly **POWER CLEANER** removes even stubborn contamination such as cement and adhesive residue and lime film and, immediately after polishing, polishing paste and cream residue. **BRILLIANCE CLEAN** removes minor contamination, completely streak-free and without residue. To preserve ground and polished surfaces, apply a thin film of **POLY SCHUTZ** when work is finished. This makes finger smudges, water spots, and shadows remain invisible for a long time. POLY SCHUTZ is also food-grade and is ideal for use in large kitchens and hotels for such items as railings, facades, and artwork. **Test it yourself!**



Technical specifications

Application	Packaging	Contents	Pkg. unit	Article number
Outdoors	Spray bottles	3 x 50 ml	1 	40061

ACCESSORIES

Basic carry case	226
Professional carrying case	226
Professional carrying case for pipe grinders	227
Hand fleece	227
Stainless steel cover plate	228
CAS high-speed charging device	229
CAS batteries	229
QUICK-LOCK cable	230
Machine stand	230
Ball joint mount	231
NEW Particulate matter protection caps	232
Particulate matter protection clip	234
Work gloves	235



SUITABLE FOR POWER TOOLS AND ACCESSORIES

Basic Carry Case

for mobile use

Sturdy, heavy-duty plastic design for use on site.



Technical specifications

Interior dimensions (L x W x H mm)	Exterior dimensions (L x W x H mm)	Can be used with	Pkg. unit 	Article number
495 x 230 x 205	500 x 250 x 240	POLY-PTX®, VARILEX®, MINI MAX®, ROHR FIX®, ROLEI EF 115, TOPRAIL 1100 HT	1	40008
400 x 190 x 180	415 x 215 x 200	VARILEX® 1100	1	40008b

SUITABLE FOR POWER TOOLS AND ACCESSORIES

Professional Carrying Case

Extremely stable

Extremely stable carrying case (survival case) for ideal protection for your grinding machine and tools.



Benefits at a glance

- **Dust-proof and splash-proof according to the IP67 standard.**
- For the **temperature range between -30 °C and 90 °C.**
- With **pyramid foam inserts** for especially good machine protection.
- Two stable, **folding handles** for upright or longitudinal carrying.
- With **automatic pressure compensation valve** for air transport.
- Especially high quality – made in the EU.

Technical specifications

Interior dimensions (L x W x H mm)	Exterior dimensions (L x W x H mm)	Can be used with	Pkg. unit 	Article number
520 x 290 x 200	574 x 361 x 225	POLY-PTX®, VARILEX®, VARILEX® POLISHER, MINI MAX®, TOPRAIL 1100 HT, ROLEI EF 115	1	50103

SUITABLE FOR POWER TOOLS AND ACCESSORIES

Professional Carrying Case

for pipe grinders



Extremely stable carrying case (survival case) for ideal protection for your pipe grinder and tools.

Benefits at a glance

- **Dust-proof and splash-proof according to the IP67 standard.**
- For the **temperature range between -30 °C and 90 °C.**
- With **pyramid foam inserts** for especially good machine protection.
- Two stable, **folding handles** for upright or longitudinal carrying.
- With **automatic pressure compensation valve** for air transport.
- Especially high quality – made in the EU.

Technical specifications

Interior dimensions (L x W x H mm)	Exterior dimensions (L x W x H mm)	Can be used with	Pkg. unit 	Article number
800 x 370 x 145	850 x 440 x 158	ROHR MAX®, ROHR SNIPER®, GLADIUS® etc.	1	50104

SUITABLE FOR STEEL · STAINLESS STEEL · NON-FERROUS METALS · WOOD · HARD PLASTICS

Hand Fleece

(supplied on a roll)

For hard to reach places, such as corners, etc.



Completely free of ferrite (iron). Ideal for stainless steel, wood, steel, non-ferrous metals, and hard plastics. High grit density for extremely long service life and uniform grinding. Supplied on practical 10-m storage rolls.

For a shadow-free industrial finish (matt and satin), removing oxide layers, and blending ground sheet metal by hand and in hard-to-reach places.

Technical specifications

Width (mm)	Length (m)	Pkg. unit 	Grit (K)	Article number
100	10	1	80	60080
			180	60180
			280	60280
			400	60400



SUITABLE FOR THE PERFECT MITRE CUT

Stainless Steel Cover Plate

for perfect mitre grinding

Stainless steel cover plate produces precision mitre edges and easy cutting with shears. Clean adhesion for perfect mitre grinding on all materials. Self-adhesive, can be removed without leaving any residue – easy control without rework guaranteed.



Technical specifications

Dimensions (mm)	Material thickness (mm)	Material	Pkg. unit 	Article number
Ø 150 x 2,500	0.1	Stainless steel (1.4301 / 304)	1	40070



SUITABLE FOR ALL CORDLESS ALLIANCE SYSTEM BATTERIES



High-Speed Charging Device



For quick charging of all sliding-fit Li-ion and LiHD battery packs from 14.4 to 36 volts.

Benefits at a glance

- **Patented "AIR COOLED" charging technology:** Batteries are cooled during charging for a much shorter charging time.
- High charging current ensures that the **battery packs are charged quickly.**
- **Very low stand-by power consumption.**
- Maximum charging current: 6.5 A.
- **Process-controlled charge management** for gentle charging and the greatest possible number of charging cycles.
- One charger for charging all battery packs from our CAS partner: www.cordless-alliance-system.com

Technical specifications

Plug type	Cable type	Mains connection (V ~ Hz)	Maximum charging current (A)	Pkg. unit	Article number
EU (C+F)	Permanent connection	220 – 240 ~ 50 – 60	6.5	1	50474

SUITABLE FOR ALL CORDLESS ALLIANCE SYSTEM DEVICES



5,5 / 8,0 Ah Battery

18 volts, LiHD technology



Powerful high-tech 18-volt battery (LiHD) for all battery-powered tools in the CAS group.

Technical specifications

Item	Power (V)	Battery capacity (Ah)	Can be used with	Weight (kg)	Pkg. unit	Article number
CAS battery 5.5 Ah	18	5.5	CAS devices	0.89	1	50463
CAS battery 8.0 Ah	18	8.0	CAS devices	0.98	1	50473

One battery, many solutions. Cross-brand. 100% Compatibility.



SUITABLE FOR POWER TOOLS WITH QUICK-LOCK

QUICK-LOCK Cable

Suitable for VARILEX® 900, 1600 & 1800, POLY-PTX® 300, 500 & 800, ROLEI EF 115, ROHR MAX®, ROHR SNIPER®, and GLADIUS® 1800.



Technical specifications

Version	Cable length (m)	Voltage (V)	Pkg. unit 	Article number
EU (C+F)	4	220 – 240	1	52004-3
EU (C+F)	10	220 – 240	1	52005-3
Plug adapter EU to UK	4		1	52004d



SUITABLE FOR ROLEI EF 165 · ROLEI PEF 500 · ROLEI BE 5

Machine Stand

for working comfortably in a standing position

Sturdy steel machine stand including fixing bolts with black powder coating for working comfortably in a standing position.



Technical specifications

Can be used with	Dimensions (L x W x H mm)	Weight (kg)	Pkg. unit 	Article number
ROLEI EF 165	245 x 215 x 660	approx. 20	1	30120
ROLEI PEF 500	505 x 305 x 660			30220
ROLEI BE 5	385 x 325 x 660			30320



SUITABLE FOR POWER TOOLS WITH M8 THREAD

Ball Joint Mount

The robust ball joint mount transforms any mobile hand-held machine into a workshop. Grinding or deburring of small parts, polishing of individual pieces or sharpening blades – all these tasks can be performed with your mobile machine thanks to the ball joint mount. The rotary handle allows the ball joint to be locked safely and without tools – in any position!

Technical specifications

Material	Mounting thread	Pkg. unit 	Article number
Aluminum, painted	M8	1	38663



Application examples



VARILEX® 1802 HT

page 16



POLY-PTX® 802 HT

page 124



ROHR MAX® 802 HT

page 176



MINI MAX® PRO 1000



GLADIUS® 1802 HT

page 186



ROHR MAX® MINI HT

SUITABLE FOR VARILEX® 1100 - MINI MAX® 1100 - PTX COMPACT HT - TOPRAIL 1100 HT - BAND-IT 1100

Particulate Matter Protection Cap

with exchangeable filter

The electrical structure is **particularly protected**, especially when there is a **high volume of dust**. Who does not know this: metal dust collects inside the electrical device and causes a short circuit, which can destroy the device.

The problem could be avoided by regularly "blowing out" the air inlet openings, but in daily practice this need for care is very often neglected. And the subsequent annoyance about a defective machine is great! **Eisenblätter provides a remedy!** In addition to the improved internal encapsulation of the current-carrying parts, the **air inlet** is shielded by means of a **newly developed particulate matter protection cap**. Despite these protective measures at the "rear" of the grinder, the speed control can be conveniently changed at any time using the setting wheel. Other products often cover the entire setting wheel.

Inside the newly developed **particulate matter protection cap** there is an **exchangeable filter fabric**, which can be easily **blown out or replaced** at any time in the event of excessive dust accumulation. The basic set contains **10 exchangeable filter fabrics**.

This smart idea increases the service life of your machines enormously!











Technical specifications

Item	Can be used with	Pkg. unit 	Article number
Particulate matter protection cap	VARILEX® 1100, MINI MAX® 1100, PTX COMPACT HT, TOPRAIL 1100 HT, BAND-IT 1100	1	40092
Exchangeable filters	Particulate matter protection cap (40092)	10	40093



Standard with these Eisenblätter machines:

  VARILEX® 1100	  MINI MAX® 1100	  BAND-IT 1100	  TOPRAIL 1100 HT	  PTX COMPACT HT
--	---	---	--	---

SUITABLE FOR CERTAIN EISENBLÄTTER POWER TOOLS

Particulate Matter Protection Cap

Greatly reduces the risk of an electronic short circuit due to metal dust

The new particulate matter protection with robust stainless steel grille prevents fine dust and contamination particles from entering the machine's interior and thus increase its service life. The breathable particulate matter protection can be easily cleaned and used many times. Just separate the particulate matter protection from the machine, clean it with a vacuum cleaner or blow it out with compressed air, and mount it on the machine's ventilation slots, where it will lock.



Technical specifications

Can be used with	Pkg. unit 	Article number
VARILEX® 1802 HT, VARILEX® POLISHER HT, POLY-PTX® 802 HT, ROHR MAX® 802 HT, ROHR MAX® HT MINI, ROHR SNIPER® 802 HT, GLADIUS® 1802 HT	1	40084



SUITABLE FOR EISENBLÄTTER CAS CORDLESS POWER TOOLS

Particulate Matter Protection Cap (cordless)

Greatly reduces the risk of an electronic short circuit due to metal dust

The new particulate matter protection with robust stainless steel grille prevents fine dust and contamination particles from entering the machine's interior and thus increase its service life. The breathable particulate matter protection can be easily cleaned and used many times. Just separate the particulate matter protection from the machine, clean it with a vacuum cleaner or blow it out with compressed air, and mount it on the machine's ventilation slots, where it will lock.



Technical specifications

Can be used with	Pkg. unit 	Article number
VARILEX® AKKU BRUSHLESS, VARILEX® POLISHER AKKU, MINI MAX® AKKU, POLY-PTX® AKKU HT, ROHR MAX® AKKU, BAND-IT AKKU	1	40087



SUITABLE FOR POLY-PTX® 800 - VARILEX® 1800 - ROLEI EF 115

Particulate Matter Protection Clip

Greatly reduces the risk of an electronic short circuit due to metal dust

The new dust protection clips prevent fine dust and contamination particles from entering the machine's interior and thus increase its service life. The breathable filter grid is easy to replace – if necessary, the operation takes a few seconds. Just remove the dust protection clip from the machine, replace the dirty filter grid with a new one, and mount it on the machine's air intake slots, where it will lock.



Technical specifications

Contents	Can be used with	Pkg. unit	Article number
2 clips + 22 filter grids	POLY-PTX® 300/500/800, VARILEX® 1600/1800, ROHR MAX®, ROHR SNIPER®, GLADIUS® 1800, ROLEI EF 115	1	40085



SUITABLE FOR DRY, HUMID AND OILY ENVIRONMENTS

Work Gloves

New work gloves for sensitivity and an outstanding grip for many applications in dry, wet, and oily environments. The EN388 standard and the good mechanical properties show that these work gloves is an outstanding all-rounder: high resistance to oil, grease, and hydrocarbons; good resistance to organic solvents; resistant to heat and abrasion.



Technical specifications

Size	Pkg. unit 	Article number
M / 8	5	40105M
L / 9	5	40105L
XL / 10	5	40105XL



Gerd Eisenblätter GmbH

Jeschkenstraße 12d
82538 Geretsried
Germany
Phone +49 8171 9082-010
Fax +49 8171 9082-220
info@eisenblaetter.de
www.eisenblaetter.de



Your Eisenblätter partner: